

Product Overview

The QPD1425 is a 375 W (P_{3dB}) discrete GaN on SiC HEMT which operates from DC to 2 GHz. The device's power and efficiency can be optimized at high drain bias operating conditions. The optimization can potentially lower system costs in terms of fewer amplifier line-ups and lower thermal management costs.

Lead-free and ROHS compliant

Evaluation boards are available upon request.



NI-400 Package

Key Features

- Frequency Range: DC to 2 GHz
- Linear Gain¹: 20.6 dB
- Output Power (P_{3dB})¹: 56.3 dBm
- Drain Efficiency (P_{3dB})¹: 75.1%
- Operating Voltage: 65 V
- CW and Pulsed Capable

Note 1: Typical EVB Performance at 1.3 GHz

Functional Block Diagram

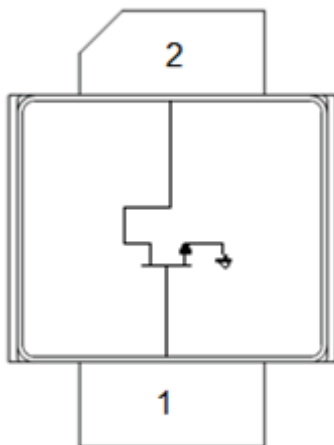

Applications

- L-Band Radar
- Military and Civilian Radar
- Professional and Military Radio Communications
- Test Instrumentation
- Wideband or Narrowband Amplifiers
- GPS Communications
- Avionics

Ordering Information

Part No.	Description
QPD1425	DC – 2.0 GHz Transistor
QPD1425EVB01	1.2 – 1.4 GHz EVB

Absolute Maximum Ratings^{1, 2, 3, 4}

Parameter	Rating	Units
Breakdown Voltage, BV_{DG}	225	V
Gate Voltage Range, V_G	-7 to +2	V
Drain Current, $I_{D_{MAX}}$	35.5	A
Power Dissipation, Pulsed, P_{DISS}^2	238	W
RF Input Power, Pulsed, P_{IN}^3	43	dBm
Operating Channel Temperature ⁴	275	°C
Storage Temperature	-65 to +150	°C

Notes:

1. Operation of this device outside the parameter ranges given above may cause permanent damage
2. Pulsed, 300us PW, 10% DC, Package base at 85 °C
3. Pulsed, 300us PW, 10% DC, T = 25 °C, 50 ohms load
4. Package base at 85 °C

Recommended Operating Conditions^{1, 2, 3, 4}

Parameter	Min	Typ	Max	Units
Operating Temp. Range	-40	+25	+85	°C
Drain Voltage Range, V_D	–	65	–	V
Drain Bias Current, I_{DQ}	–	430	–	mA
Drain Current, I_D^4	–	19	–	A
Gate Voltage, V_G^3	–	-2.7	–	V
Power Dissipation (P_D) ^{2,4}	–	–	238	W
Power Dissipation (P_D), CW ²	–	–	128	W

Notes:

1. Electrical performance is measured under conditions noted in the electrical specifications table. Specifications are not guaranteed over all recommended operating conditions
2. Package base at 85 °C
3. To be adjusted to desired I_{DQ}
4. Pulsed, 300us PW, 10% DC

Measured Load Pull Performance – 65V Power Tuned^{1, 2}

Parameter	Typical Values			Units
	1.2	1.3	1.4	
Frequency, F	1.2	1.3	1.4	GHz
Output Power at 3dB compression, P_{3dB}	57.1	57.2	56.9	dBm
Drain Efficiency at 3dB compression, $DEff_{3dB}$	70.5	71.3	62.3	%
Gain at 3dB compression, G_{3dB}	16.8	16.7	15.9	dB

Notes:

1. Test conditions unless otherwise noted: $T_A = 25$ °C, $V_D = 65$ V, $I_{DQ} = 430$ mA
2. Pulsed, 300 us Pulse Width, 10% Duty Cycle.

Measured Load Pull Performance – 65V Efficiency Tuned^{1, 2}

Parameter	Typical Values			Units
	1.2	1.3	1.4	
Frequency, F	1.2	1.3	1.4	GHz
Output Power at 3dB compression, P_{3dB}	55.5	54.2	55.0	dBm
Drain Efficiency at 3dB compression, $DEff_{3dB}$	81.1	81.4	79.3	%
Gain at 3dB compression, G_{3dB}	18.4	18.5	18.1	dB

Notes:

1. Test conditions unless otherwise noted: $T_A = 25$ °C, $V_D = 65$ V, $I_{DQ} = 430$ mA
2. Pulsed, 300 us Pulse Width, 10% Duty Cycle.

Measured Load Pull Performance – 50V Power Tuned ^{1,2}

Parameter	Typical Values			Units
	1.2	1.3	1.4	
Frequency, F	1.2	1.3	1.4	GHz
Output Power at 3dB compression, P _{3dB}	56.2	56.1	55.9	dBm
Drain Efficiency at 3dB compression, DEff _{3dB}	69.2	68.3	68.6	%
Gain at 3dB compression, G _{3dB}	16.1	15.9	15.8	dB

Notes:

3. Test conditions unless otherwise noted: T_A = 25 °C, V_D = 50 V, I_{DQ} = 430 mA
4. Pulsed, 300 us Pulse Width, 10% Duty Cycle.

Measured Load Pull Performance – 50V Efficiency Tuned ^{1,2}

Parameter	Typical Values			Units
	1.2	1.3	1.4	
Frequency, F	1.2	1.3	1.4	GHz
Output Power at 3dB compression, P _{3dB}	52.5	53.1	53.7	dBm
Drain Efficiency at 3dB compression, DEff _{3dB}	80.7	79.6	80.4	%
Gain at 3dB compression, G _{3dB}	18.1	17.6	17.4	dB

Notes:

3. Test conditions unless otherwise noted: T_A = 25 °C, V_D = 50 V, I_{DQ} = 430 mA
4. Pulsed, 300 us Pulse Width, 10% Duty Cycle.

RF Characterization – 1.2 – 1.4 GHz EVB, 65V Performance¹ at 1.3 GHz

Parameter	Min	Typ	Max	Units
Linear Gain	–	20.6	–	dB
Output Power at P3dB	–	56.3	–	dBm
Drain Efficiency at P3dB	–	75.1	–	%
Gain at P3dB	–	17.6	–	dB
Gate Leakage ($V_D = 10V$, $V_G = -3.3V$) at DC	-40	–	–	mA

Notes:

- $V_D = 65 V$, $I_{DQ} = 430 mA$, Temp = +25 °C, Pulse Width = 300 us, Duty Cycle = 10%

RF Characterization – 1.2 – 1.4 GHz EVB, 50V Performance¹ at 1.3 GHz

Parameter	Min	Typ	Max	Units
Linear Gain	–	20.3	–	dB
Output Power at P3dB	–	54.3	–	dBm
Drain Efficiency at P3dB	–	76.0	–	%
Gain at P3dB	–	17.3	–	dB
Gate Leakage ($V_D = 10V$, $V_G = -3.3V$) at DC	-40	–	–	mA

Notes:

- $V_D = 50 V$, $I_{DQ} = 430 mA$, Temp = +25 °C, Pulse Width = 300 us, Duty Cycle = 10%

RF Characterization – Mismatch Ruggedness at 1.3 GHz ^{1, 2, 3}

Symbol	Parameter	dB Compression	Typical
VSWR	Impedance Mismatch Ruggedness	3	10:1

Notes:

- Test conditions unless otherwise noted: $T_A = +25 °C$, $V_D = 65 V$, $I_{DQ} = 430 mA$
- Input drive power is determined at pulsed 3dB compression under matched condition at EVB output connector
- Pulse Width = 300us, Duty cycle = 10%

Thermal and Reliability Information – Pulsed ¹

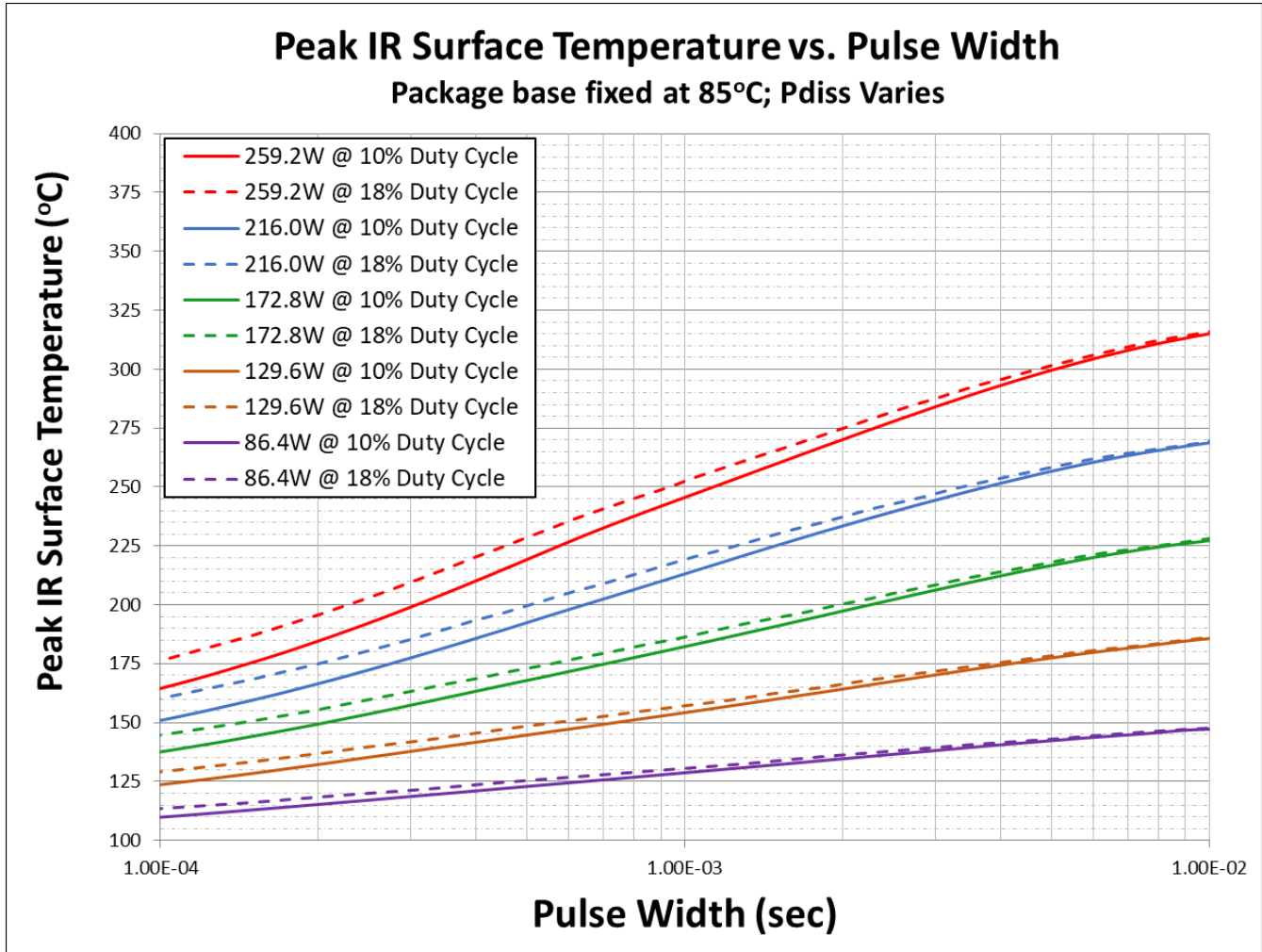

Parameter	Conditions	Values	Units
Thermal Resistance, IR ¹ (θ_{JC})	85 °C Case backside Temperature	0.43	°C/W
Peak IR Surface Temperature ¹ (T_{ch})	P _{diss} = 216 W, Pulse: 300 us PW, 10% DC	177.5	°C

Notes:

1. Refer to the following document [GaN Device Channel Temperature, Thermal Resistance, and Reliability Estimates](#)

Measured Load-Pull Smith Charts at 65V ¹

Notes:

1. Test Conditions: $V_D = 65\text{ V}$, $I_{DQ} = 430\text{ mA}$, 300 us Pulse Width, 10% Duty Cycle, Temp = 25°C.

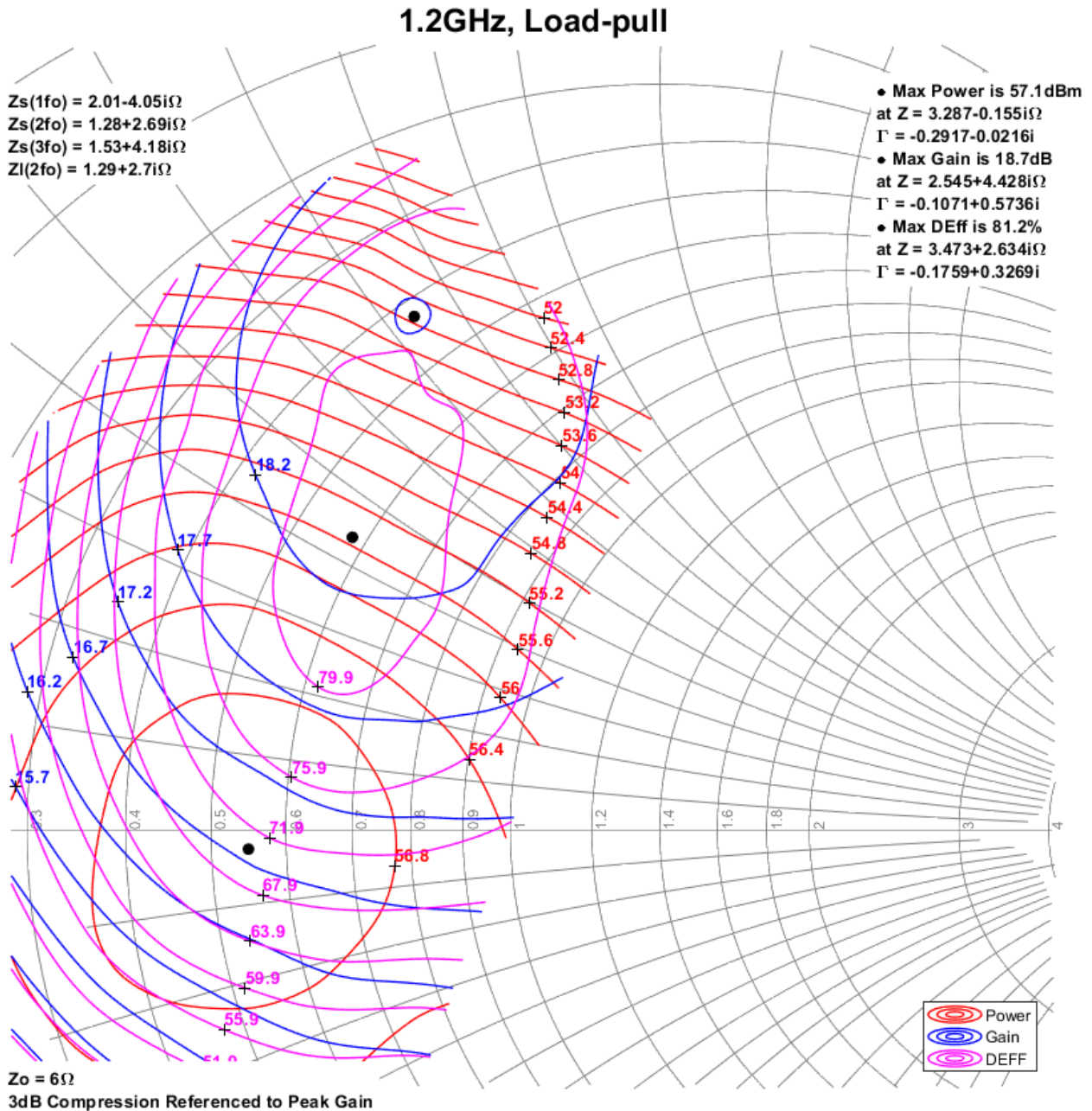

Measured Load-Pull Smith Charts at 65V ¹

Notes:

1. Test Conditions: $V_D = 65\text{ V}$, $I_{DQ} = 430\text{ mA}$, 300 us Pulse Width, 10% Duty Cycle, Temp = 25°C.

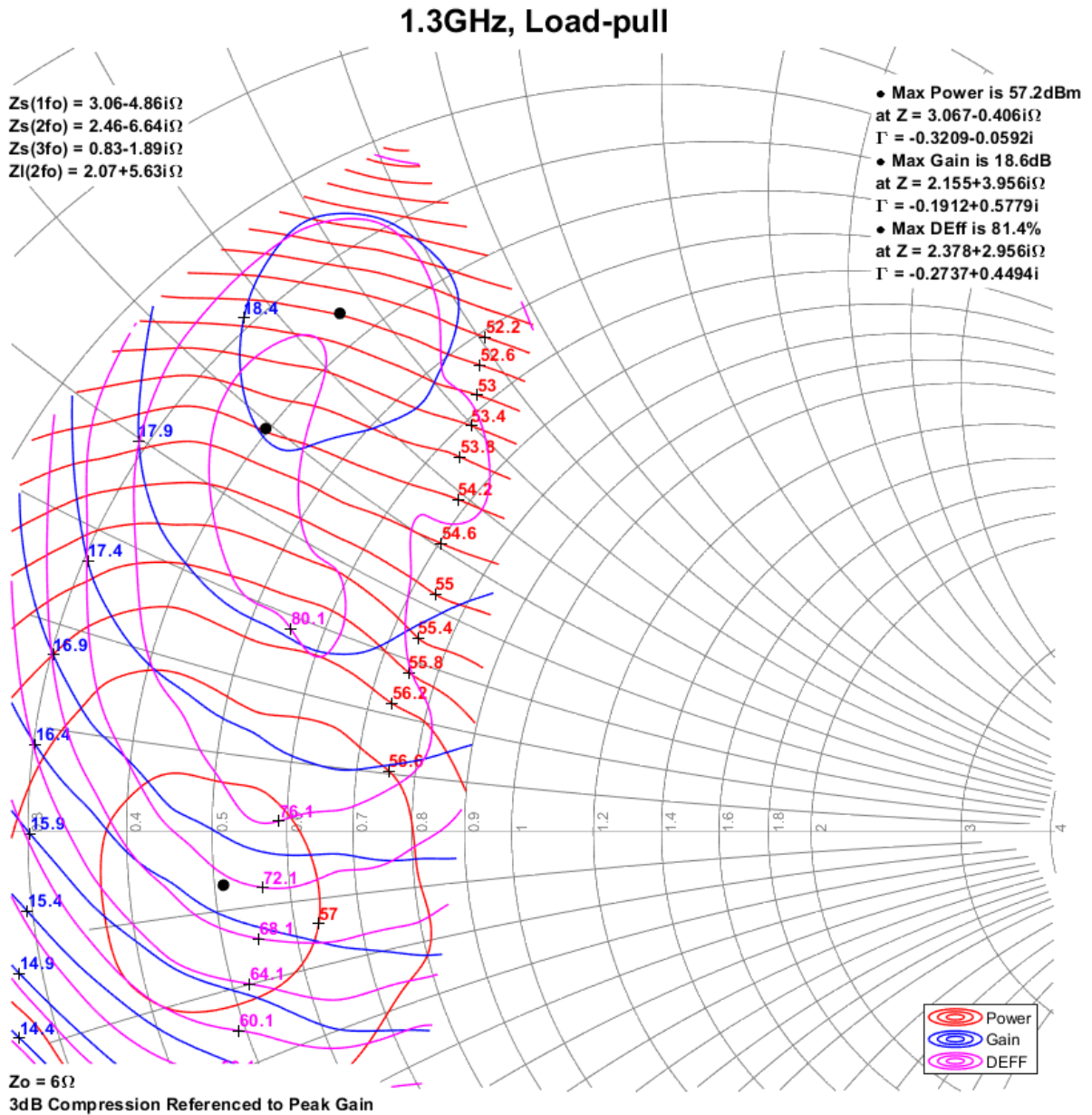

Measured Load-Pull Smith Charts at 65V ¹

Notes:

1. Test Conditions: $V_D = 65\text{ V}$, $I_{DQ} = 430\text{ mA}$, 300 us Pulse Width, 10% Duty Cycle, Temp = 25°C.

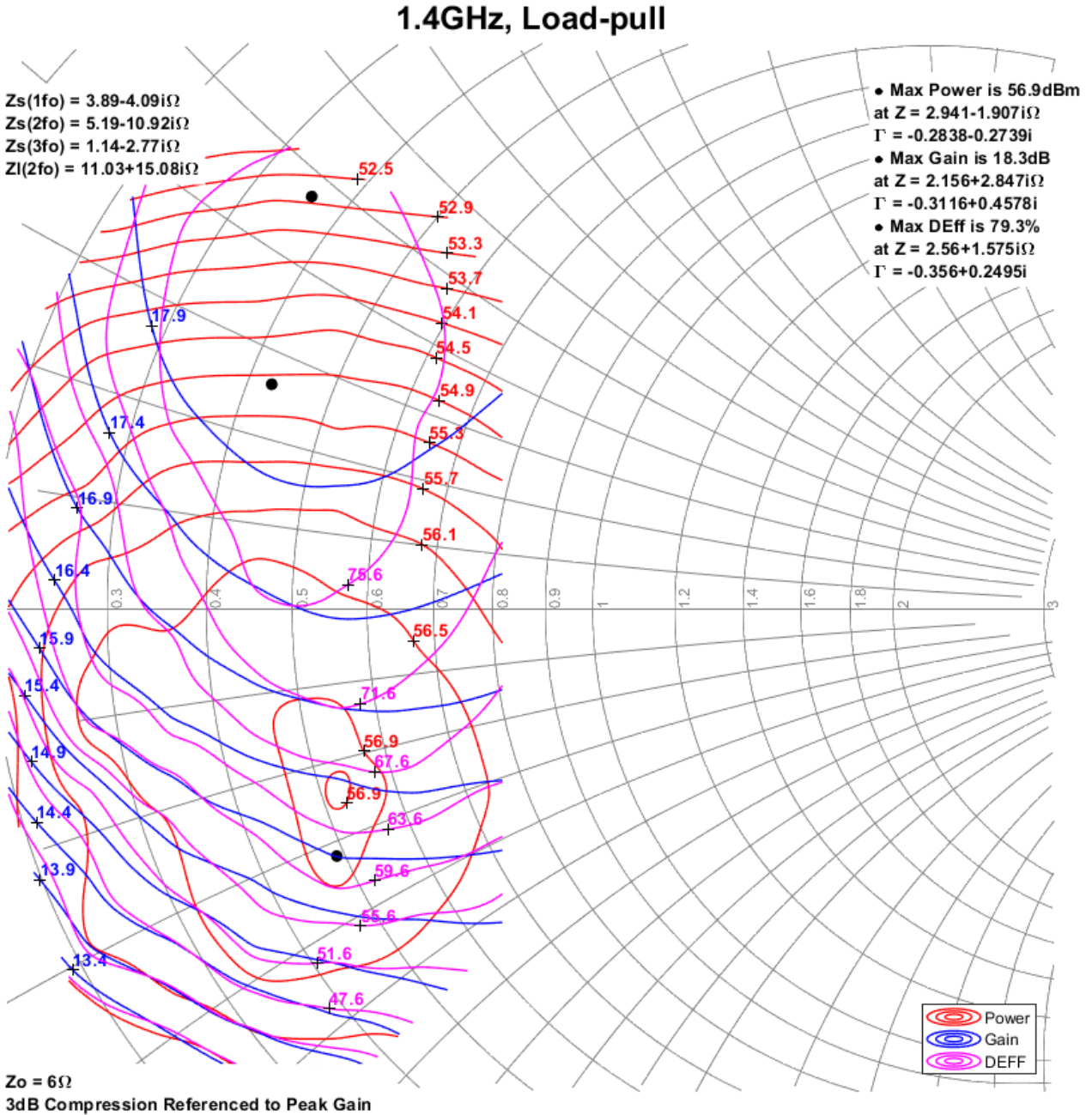

Measured Load-Pull Smith Charts at 50V ¹

Notes:

1. Test Conditions: $V_D = 50\text{ V}$, $I_{DQ} = 430\text{ mA}$, 300 us Pulse Width, 10% Duty Cycle, Temp = 25°C.

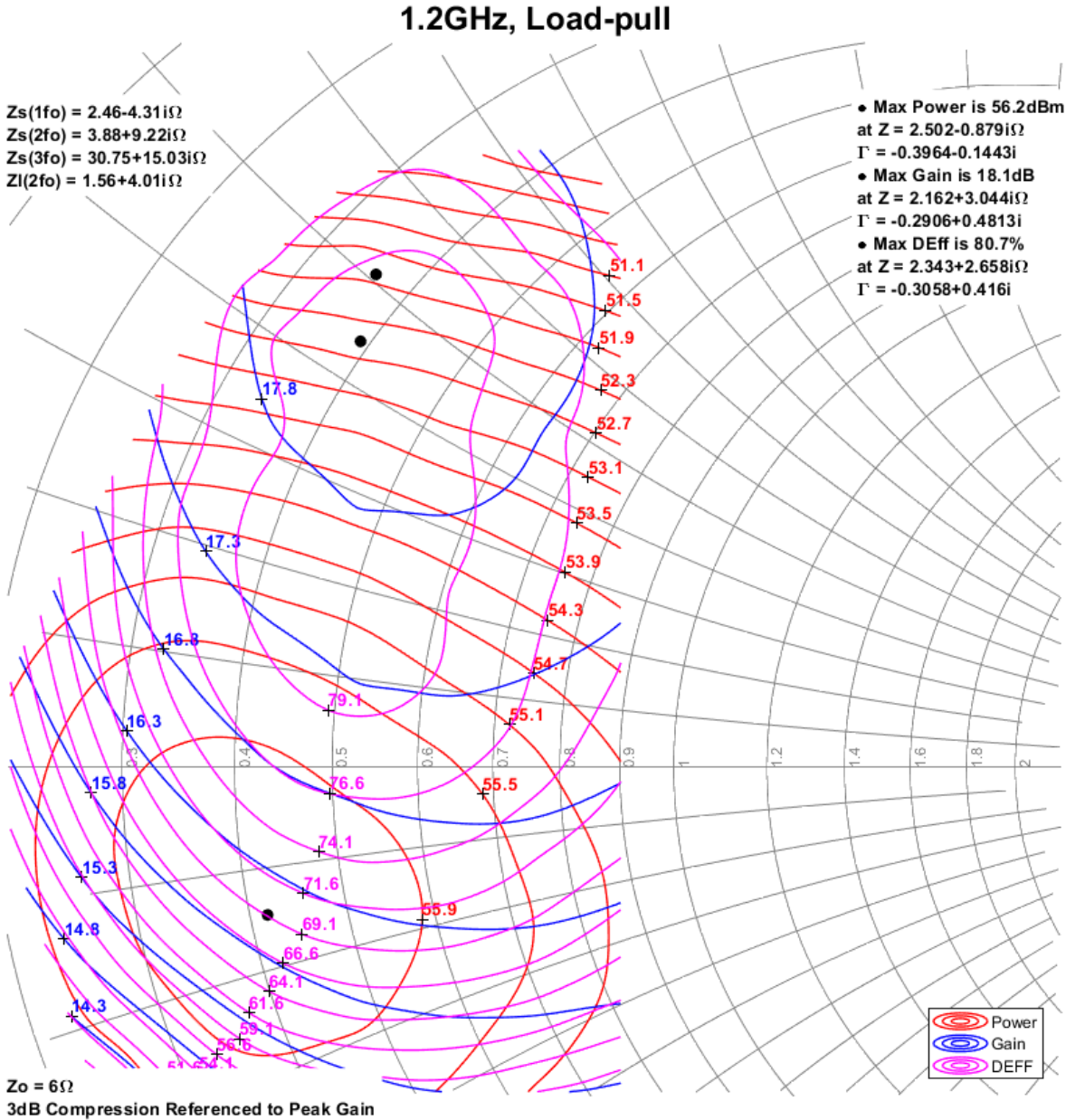

Measured Load-Pull Smith Charts at 50V ¹

Notes:

1. Test Conditions: $V_D = 50\text{ V}$, $I_{DQ} = 430\text{ mA}$, 300 us Pulse Width, 10% Duty Cycle, Temp = 25°C.

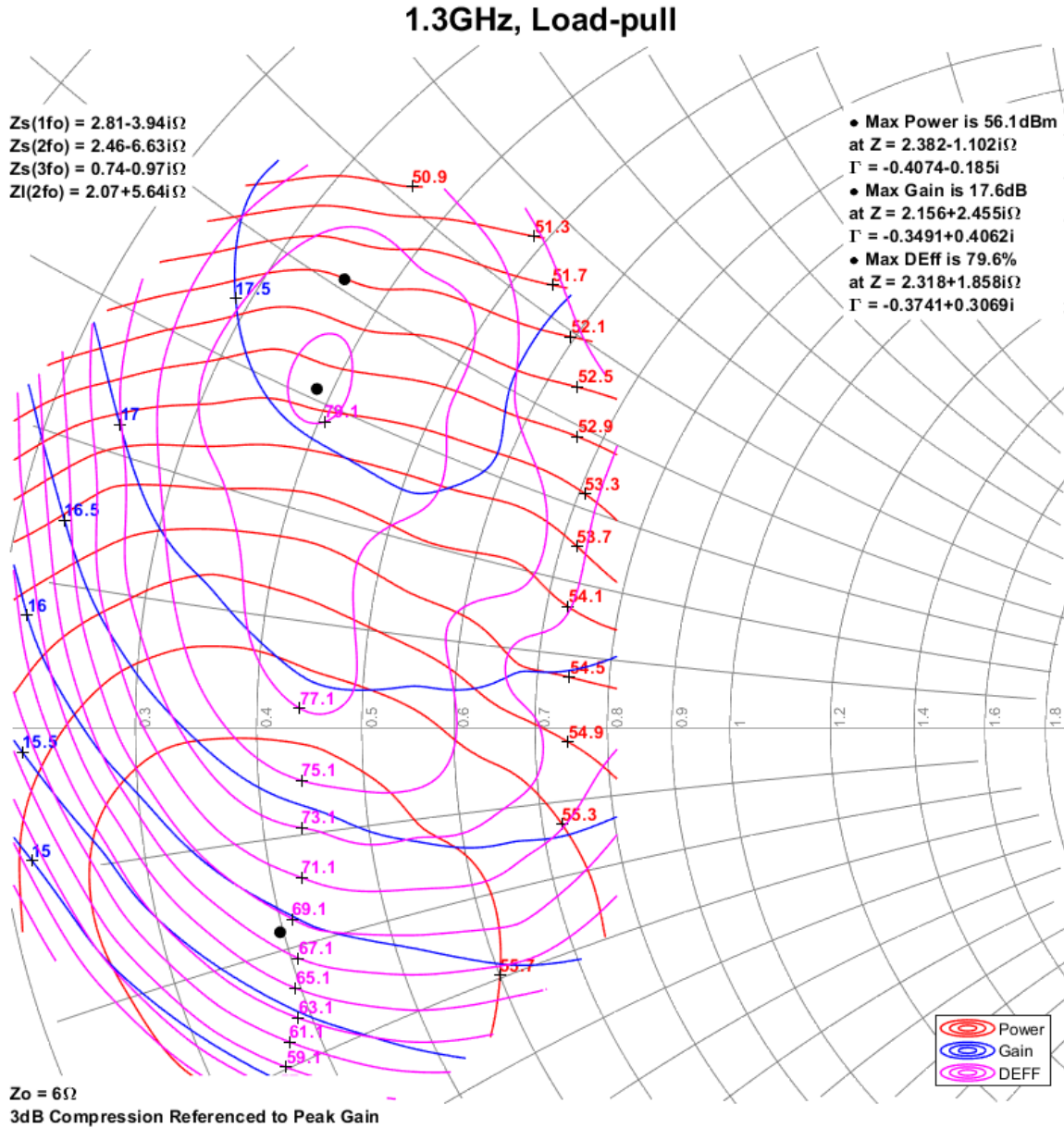

Measured Load-Pull Smith Charts at 50V ¹

Notes:

1. Test Conditions: $V_D = 50\text{ V}$, $I_{DQ} = 430\text{ mA}$, 300 us Pulse Width, 10% Duty Cycle, Temp = 25°C.

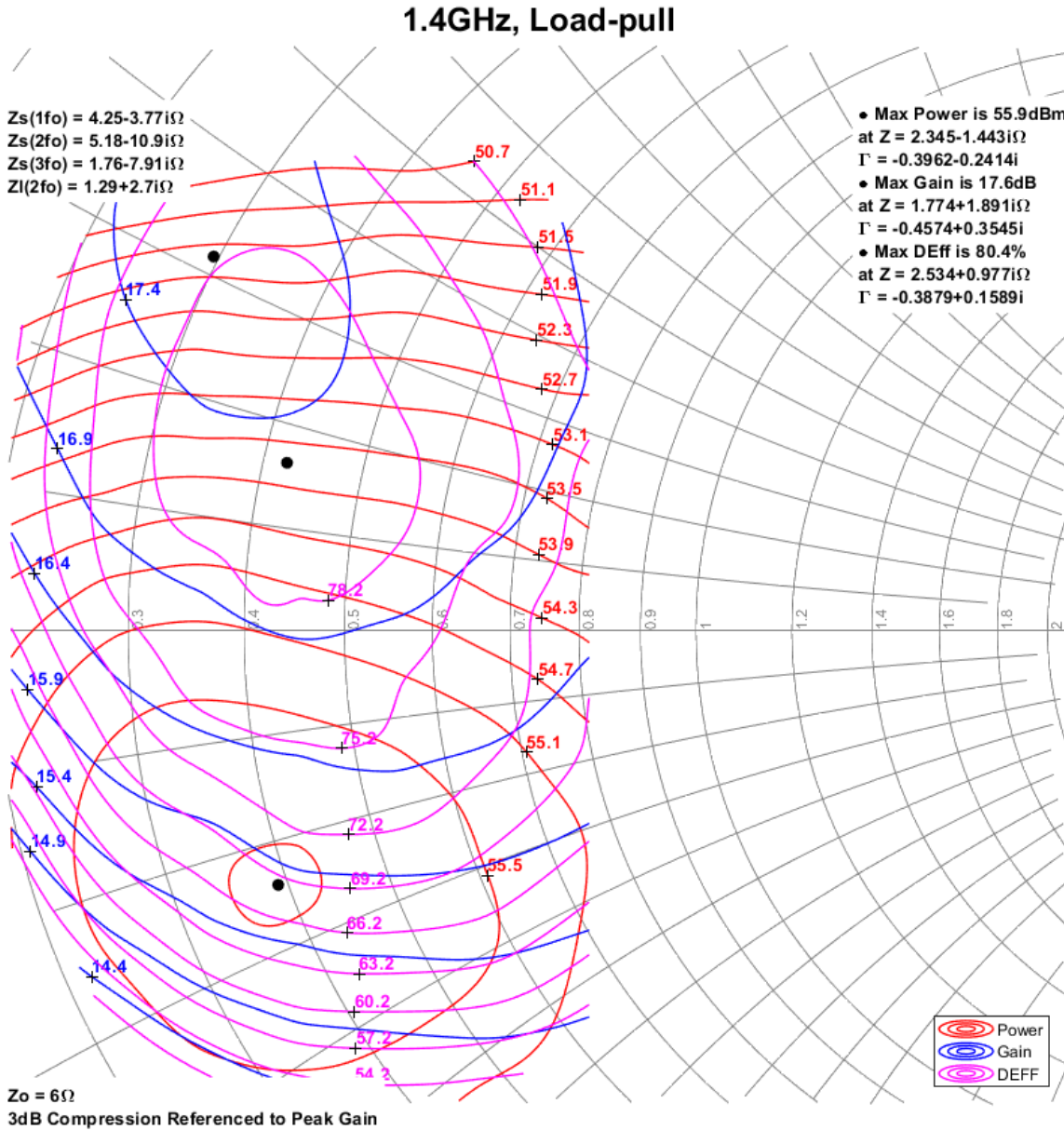

Pin Configuration and Description¹

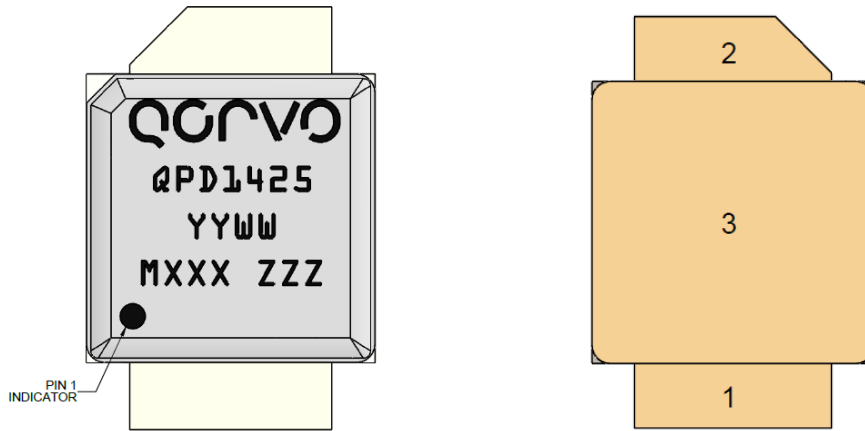

Note:

- The QPD1425 will be marked with the “QPD1425” designator and a lot code marked below the part designator. The “YY” represents the last two digits of the calendar year the part was manufactured, the “WW” is the week number of the assembly lot start, the “MXXX” is the batch ID, and the “ZZZ” is a serial number for all parts within one assembly lot.

Pin	Symbol	Description
1	RF IN / V_G	Gate
2	RF OUT / V_D	Drain
3	GND	Source / Ground

Mechanical Drawing¹⁻⁷

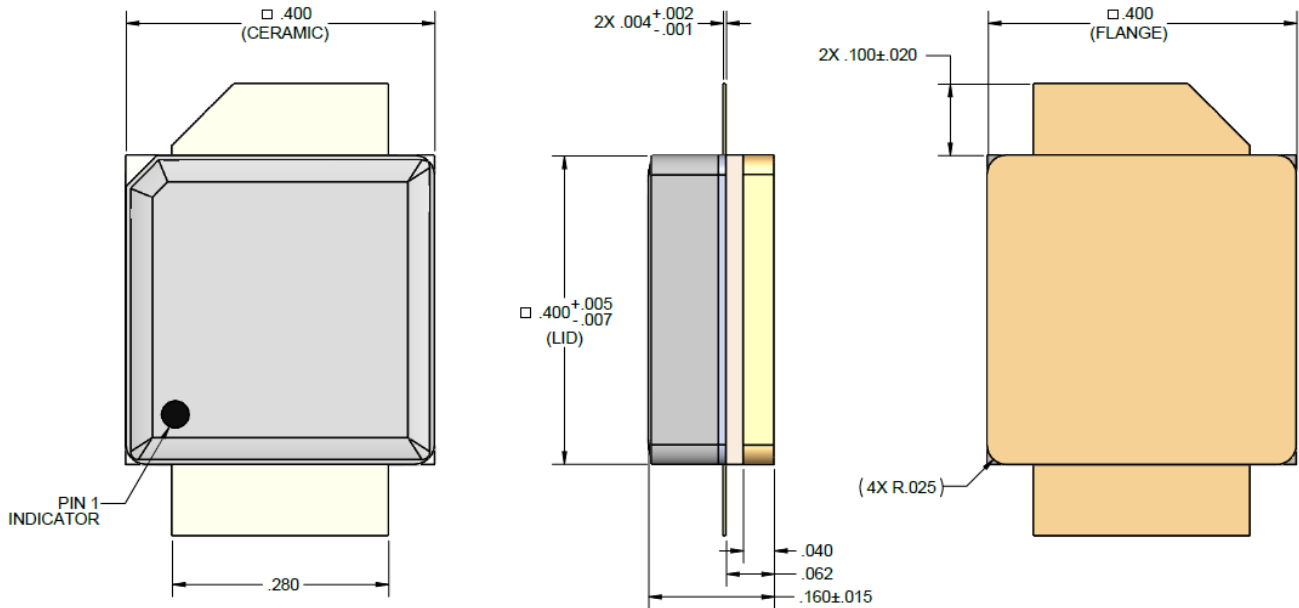

Notes:

1. All Dimensions are in inches.
2. Dimensions tolerance is ± 0.005 inches, unless noted otherwise.
3. Package Base: Ceramic/Metal. Package Lid: Ceramic
4. Package exposed metallization is gold plated.
5. Part is epoxy sealed.
6. Parts meet industry NI400 footprint.
7. Body dimensions do not include lid shift or epoxy run out which can be up to 0.020" per side.

1.2 – 1.4 GHz Application Circuit - Schematic

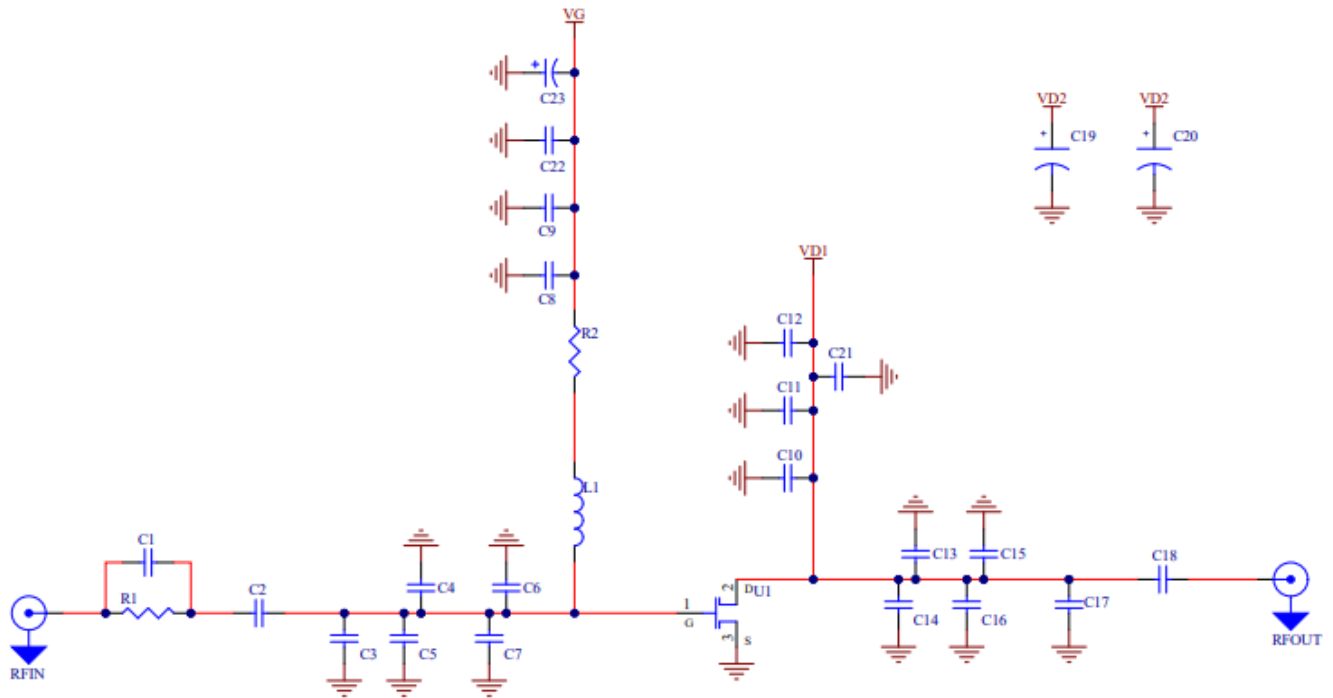

Biasing Procedure

Bias On

1. Turn ON V_G to -5 V.
2. Turn ON V_D to $+65$ V.
3. Slowly adjust V_G until $I_D = 430$ mA.
(Typically, $V_G = -2.8$ V.)
4. Turn ON RF.

Bias Off

1. Turn OFF RF.
2. Adjust V_G to -5 V.
3. Turn OFF V_D .
4. Wait two (2) seconds to allow drain capacitors to discharge.
5. Turn OFF V_G .

1.2 – 1.4 GHz Application Circuit – EVB Assembly ¹

Notes:

1. PCB material is RO4350B 0.020" thick, 1 oz. copper cladding on top and bottom layer.

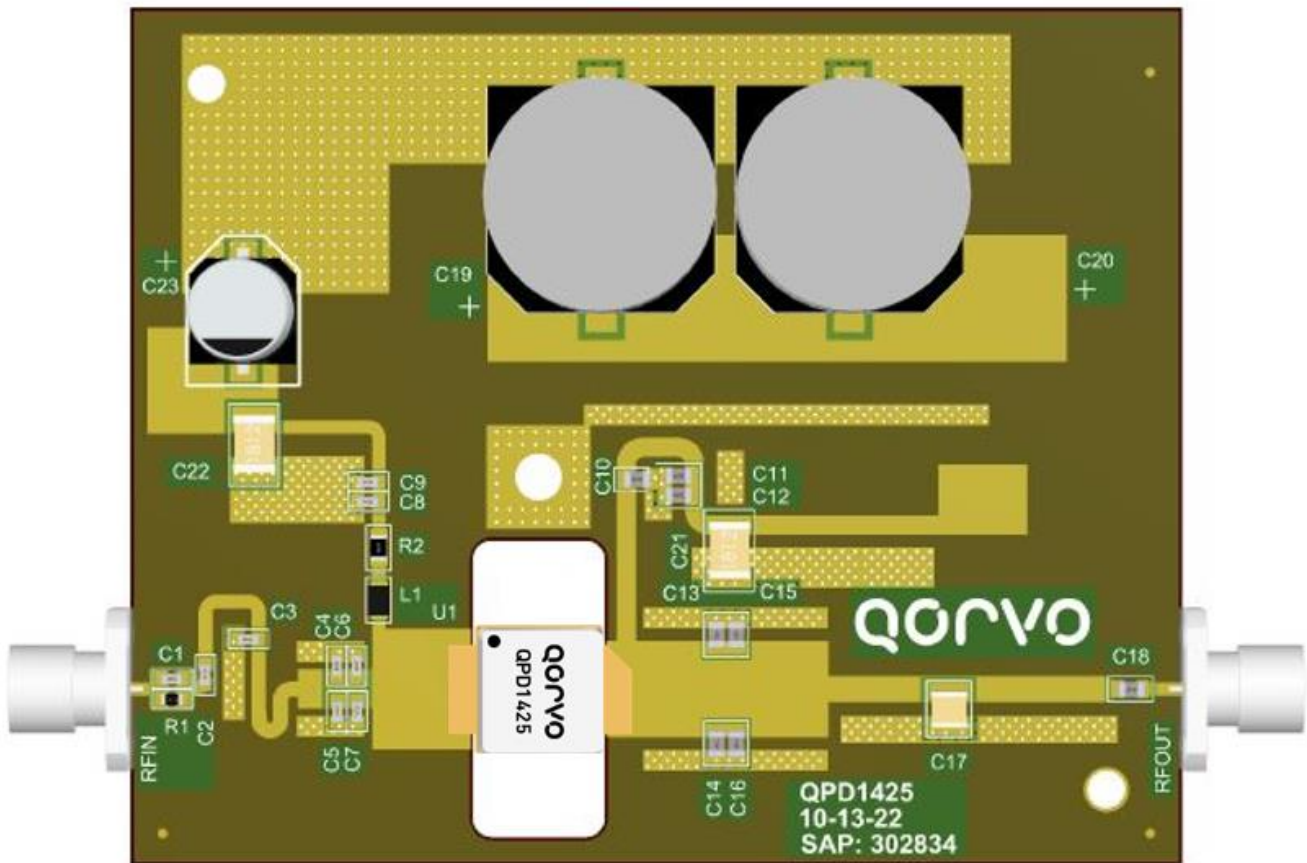

1.2 – 1.4 GHz Application Circuit EVB – Bill of Material

Ref Des	Qty	Description	Mfg Name	Mfg Part #
U1	1	1.2-1.4 GHz Discrete	Qorvo	QPD1425
C1, C8	2	CAP, 12pF, +/-5%, 250V, HI-Q, 0603	AVX	600S120JT250XT
C2	1	CAP, 68pF, 5%, 250V, LF, 0603	AVX	600S680JT250XT
C3	1	CAP, 1pF, +/-0.05pF, 250V, HI-Q, 0603	AVX	600S1R0AT250XT
C4, C5	2	CAP, 1.8pF, +/-0.1pF, 250V, HI-Q, 0603	AVX	600S1R8BT250XT
C6, C7	2	CAP, 2.4pF, +/-0.1pF, 250V, HI-Q, 0603	AVX	600S2R48BT250XT
C9	1	CAP, 100pF, +/-5%, 250V, HI-Q, 0603	AVX	600S101JT250XT
C10	1	CAP, 100pF, 5%, 250V, HI-Q, 0805	AVX	600F101JT250XT
C11	1	CAP, 1000pF, 5%, 100V, X7R, 0805	AVX	08051C102JAT2A
C13, C14	2	CAP, 5.6pF, +/-0.1pF, 250V, HI-Q, 0805	AVX	600F5R6CT250XT
C15, C16	2	CAP, 2.4pF, 0.1pF, 250V, C0G, 0805	AVX	600F2R4BT250XT
C17	1	CAP, 3.9pF, +/-0.25pF, 500V, 1111	AVX	800B3R9CT500XT
C18	1	CAP, 39pF, 5%, 250V, C0G, 0805	AVX	600F390JT250XT
C19, C20	2	CAP, 680uF, +/-20%, 80V, Alum Elec	Vishay	MAL215099708E3
C21, C22	2	CAP, 1uF, 10%, 100V, X7R, 1812	AVX	LD121C105KAB2A
C23	1	CAP, 100uF, 20%, 16V, Alum Elec	Panasonic	EEE-TC1C101P
L1	1	IND, 5.6nH, 5%, 0805	Coilcraft	0805CS-050XJLB
R1	1	RES, 100 OHM, 1%, 0.1W, 0603	Kamaya	RMC1/16K1000FTP
R2	1	RES, 10 OHM, 1%, 1/8W, 0805	Panasonic	ERJ-6ENF10R0V
RFIN, RFOUT	2	CONN, SMA (PSF-S00-000)	Powell Electronics	PSF-S00-000

P3dB Performance over Temperature of 1.2 – 1.4 GHz EVB ¹

Notes:

1. Test Conditions: $V_D = 65\text{ V}$, $I_{DQ} = 430\text{ mA}$, 300 us Pulse Width, 10% Duty Cycle.

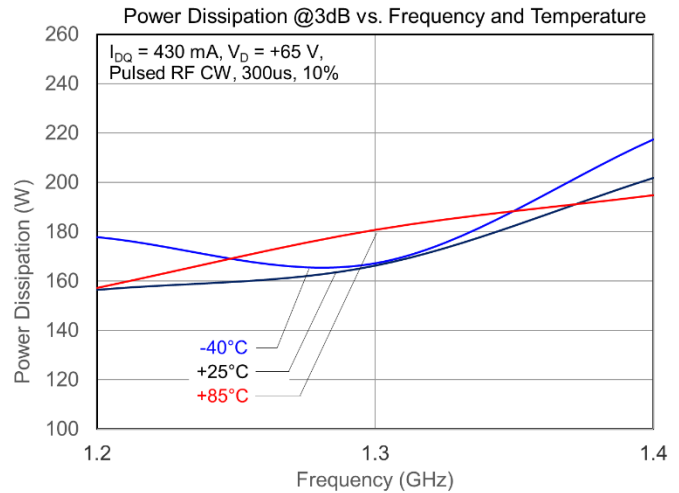
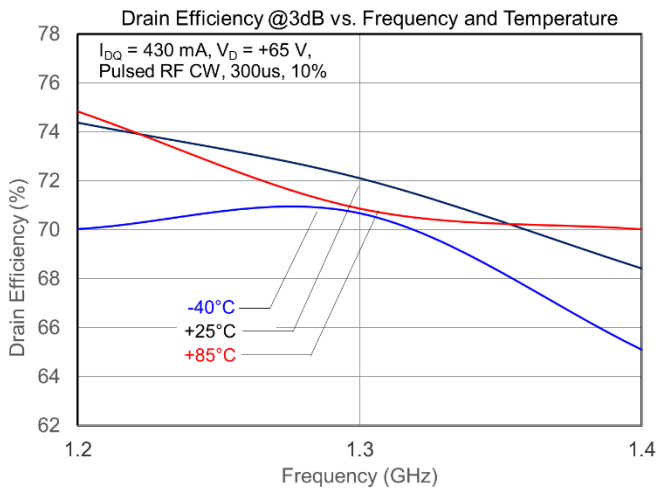
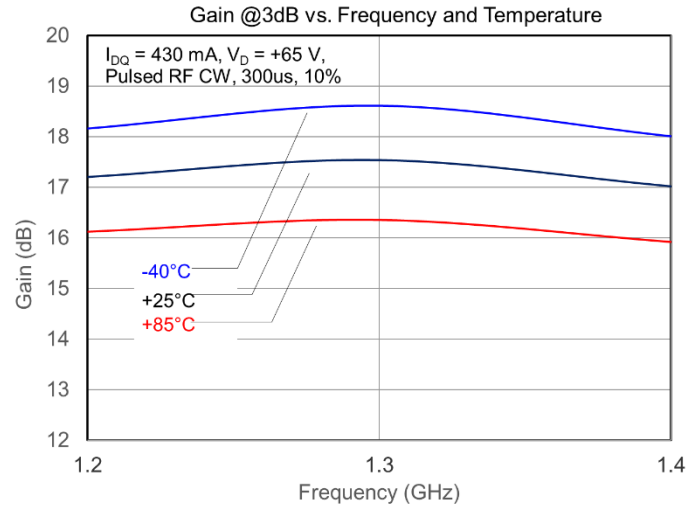
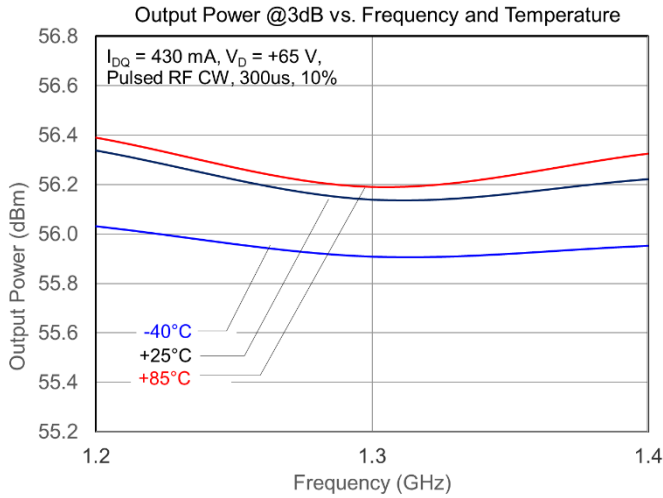

Power Drive-up Performance over Temperatures of 1.2 – 1.4 GHz EVB ¹

Notes:

1. Test Conditions: $V_D = 65\text{ V}$, $I_{DQ} = 430\text{ mA}$, 300 us Pulse Width, 10% Duty Cycle.

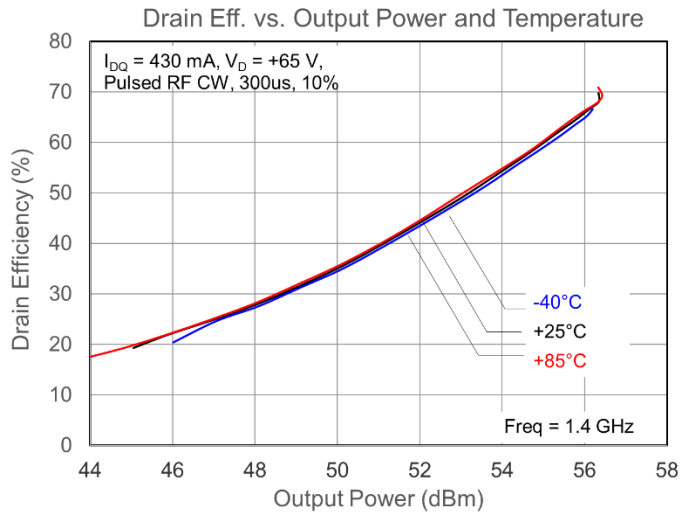
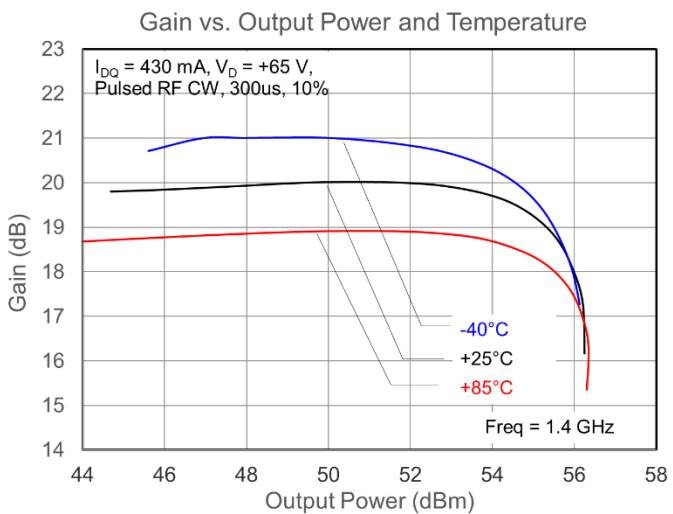
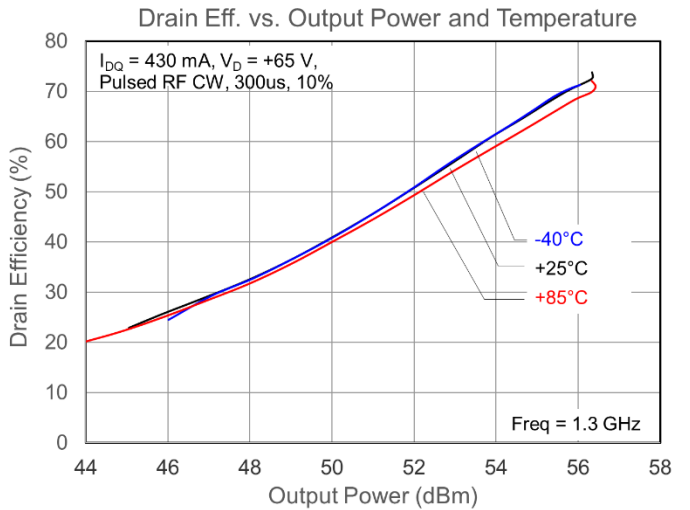
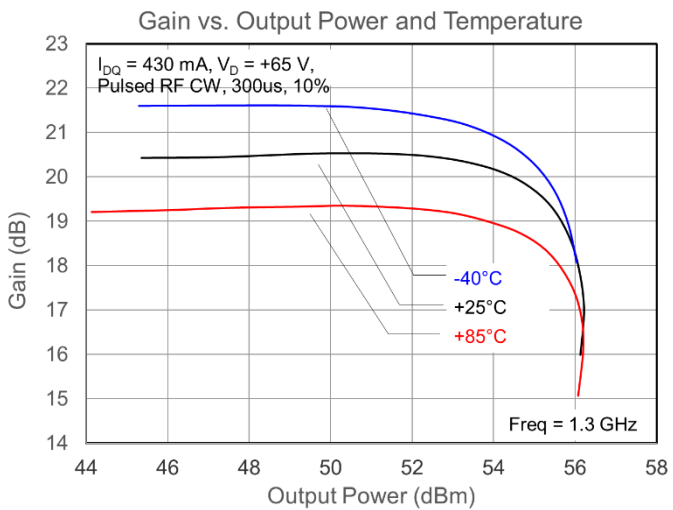
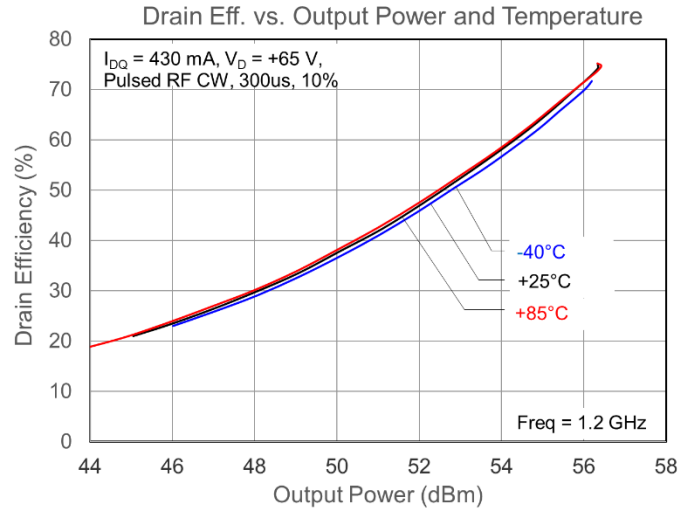
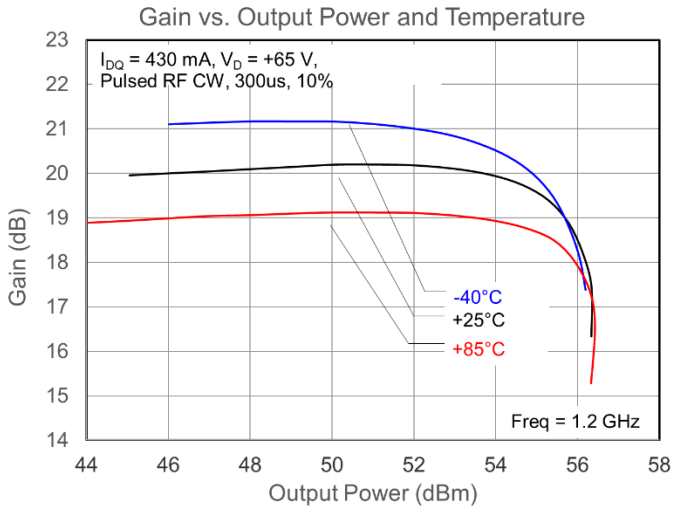

Recommended Solder Temperature Profile

