

### Product Overview

The QPL1163 is an ultra-linear GaAs pHEMT 75-Ohm differential amplifier IC with 5–1218 MHz operating bandwidth. This amplifier provides 19dB of gain and very low noise figure. The Differential push-pull topology provides excellent 2<sup>nd</sup> order intermodulation performance. The QPL1163 can be used as a low noise balanced amp in DOCSIS downstream, as well as upstream applications, due to its wide operational bandwidth. The QPL1163 is packaged in a SOIC-8 plastic package.



8-Pin SOIC Package

### Functional Block Diagram

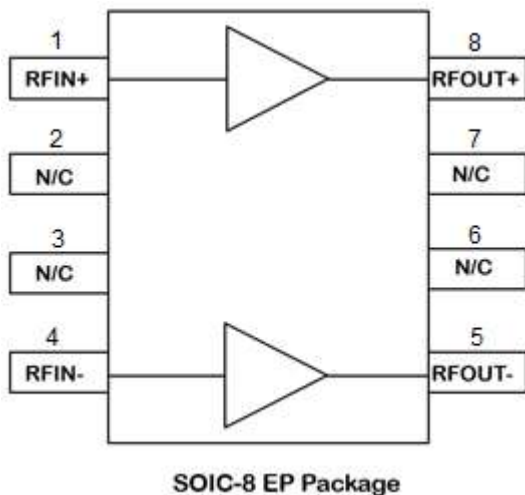

### Key Features

- High Gain: 19dB at 1218 MHz
- 5–1218 MHz BW
- OIP3: +42 dBm, Downstream 50–1218 MHz
- OP1dB: 26 dBm, Downstream 50–1218 MHz
- Low Noise Figure: < 2.4 dB, Full Band
- Excellent Composite Distortion
- pHEMT GaAs device technologies
- Compact Size: 8-pin SOIC
- 5 to 8V supply voltage operation

### Applications

- DOCSIS 3.1 Systems
- Balanced Antenna Applications
- HFC Optical Nodes
- 75 Ω Amplifiers
- Upstream Amplifier for DOCSIS 3.1 and DOCSIS 4.0 Applications

### Ordering Information

Part Number	Description
QPL1163SB	Sample bag with 5 pieces
QPL1163SR	7" Reel with 100 pieces
QPL1163TR13	13" Reel with 2500 pieces
QPL1163EVB-01	5V, 50 – 1218 MHz Eval Board
QPL1163EVB-02	5V, 5 – 700 MHz Eval Board
QPL1163EVB-03	8V, 50 – 1218 MHz Eval Board
QPL1163EVB-04	8V, 5 – 700 MHz Eval Board

## Absolute Maximum Ratings

Parameter	Rating
Supply Voltage (V <sub>DD</sub> )	+10 V
Supply Current (I <sub>DD</sub> )	400 mA
Maximum Input Level	+15 dBm
Operating Temperature Range	-40 to +100 °C
Storage Temperature Range	-40 to +150 °C
Maximum Junction Temperature	+150 °C

Exceeding any one or a combination of the Absolute Maximum Rating conditions may cause permanent damage to the device. Extended application of Absolute Maximum Rating conditions to the device may reduce device reliability.

## Electrical Specifications for Downstream (50 – 1218 MHz)

Parameter	Condition <sup>(1)</sup>	Min	Typ	Max	Unit
Supply Voltage (V <sub>DD</sub> )			5 / 8		V
Supply Current (I <sub>DD</sub> )	V <sub>DD</sub> total current		275 / 330		mA
Frequency Range		50		1218	MHz
Gain	50 – 1218 MHz		19		dB
Gain Flatness	50 – 1218 MHz		±0.5		dB
Input Return Loss	50 – 1218 MHz		20		dB
Output Return Loss	50 – 1218 MHz		20		dB
Noise Figure	50 MHz 1218 MHz		1.8 2.4		dB
CSO	79 Ch, 0dB tilt, +39dBmV / Ch Output, QAM to 1000 MHz, Downstream		86		dBc
CTB			68		dBc
CIN			68		dB
OIP2	+12 dBm / tone, Δf = 53 MHz, 50-1218 MHz		62		dBm
OIP3	+12 dBm / tone, Δf = 6 MHz, 50-1218 MHz		41		dBm
Output P1dB	50 – 1218 MHz		27		dBm
Thermal Resistance			20		°C/W

Notes:

1. Typical performance at these conditions: Temp = +25 °C, V<sub>DD</sub> = +5V, 75 Ω system, Full band unless otherwise noted.
2. Downstream (Forward Path) Freq Range is 50-1218 MHz

### Evaluation Board Schematic for Downstream (5V, 50 – 1218 MHz)

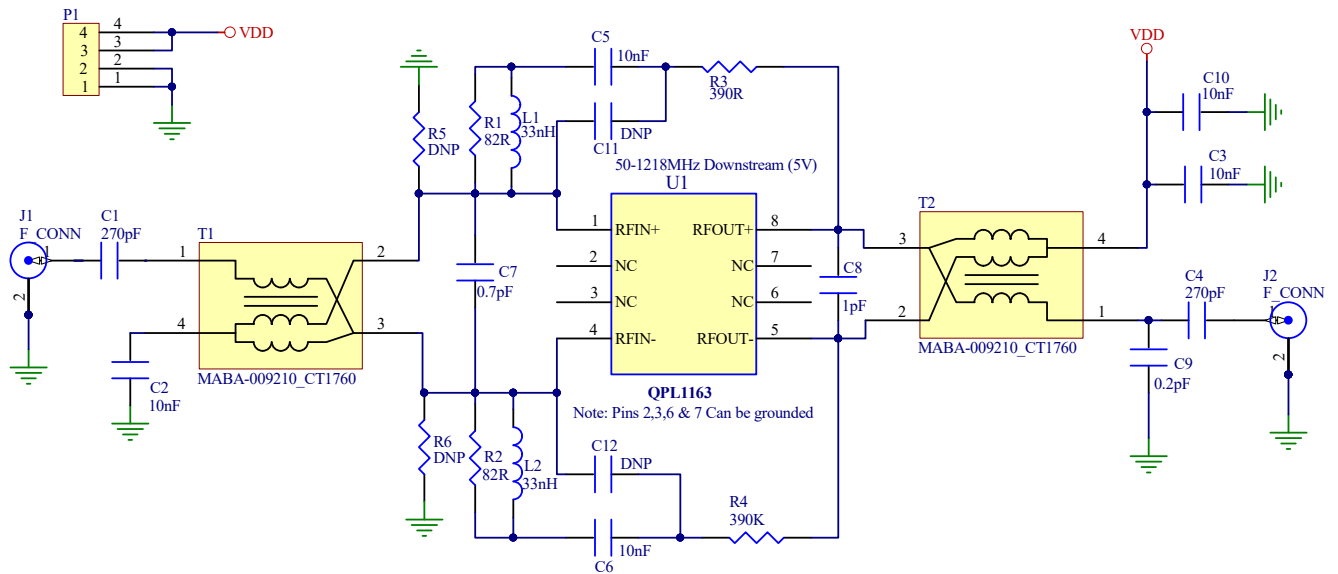

### Bill of Material for Downstream (5V, 50 – 1218MHz)

Reference Designator	Description	Manufacturer	Part Number
U1	1218 MHz, 19 dB Push-Pull Amp	Qorvo	QPL1163SB
PCB	EVB PCB, QPL1163/1240	Qorvo	SAP # 302353
C1, C4	CAP, 270 pF, 5 %, 0402	Murata	GCM1555C1H271JA16D
C2, C3, C5, C6, C10	CAP, 0.01 uF, 5 %, 50 V, 0402	Murata	GRM1555C1H103JA01D
C7	CAP, 0.7pF, ±0.05pF, 50V, HI-Q, 0402	Murata	GJM1555C1HR70WB01D
C8	CAP, 1pF, +/-0.05pF, 50V, HI-Q, 0402	Murata	GJM1555C1H1R0WB01D
C9	CAP, 0.2pF, +/-0.1pF, 50V, HI-Q, 0402	Murata	GJM1555C1HR20BB01D
L1, L2	IND, 33nH, 5%, M/L, 0402	Murata	LQG15HN33NJ02D
R1, R2	RES, 82 OHM, 5%, 1/16W, 0402	Kamaya	RMC1/16S-820JTH
R3, R4	RES, 390 OHM, 5%, 1/16W, 0402	Kamaya	RMC1/16S-391JTH
T1, T2	BALUN, 1:1	MACOM	MABA-009210-CT1760*
P1	CONN, HDR	Samtec	TSW-103-07-G-S
J1, J2	CONN, F FEM, 75OHM	Millimeter Wave	MW-846-C-DD-75
Heatsink	HEATSINK, 50 x 50 x10, ALUMINUM	Alpha Nova Tech	S08EFV05-A
C11, C12, R5, R6	DNP		

\* Alternate balun: MRFXF0072

\* For 8V operation, populate R5 and R6 with 12K Ohm Resistors

### Evaluation Board Layout

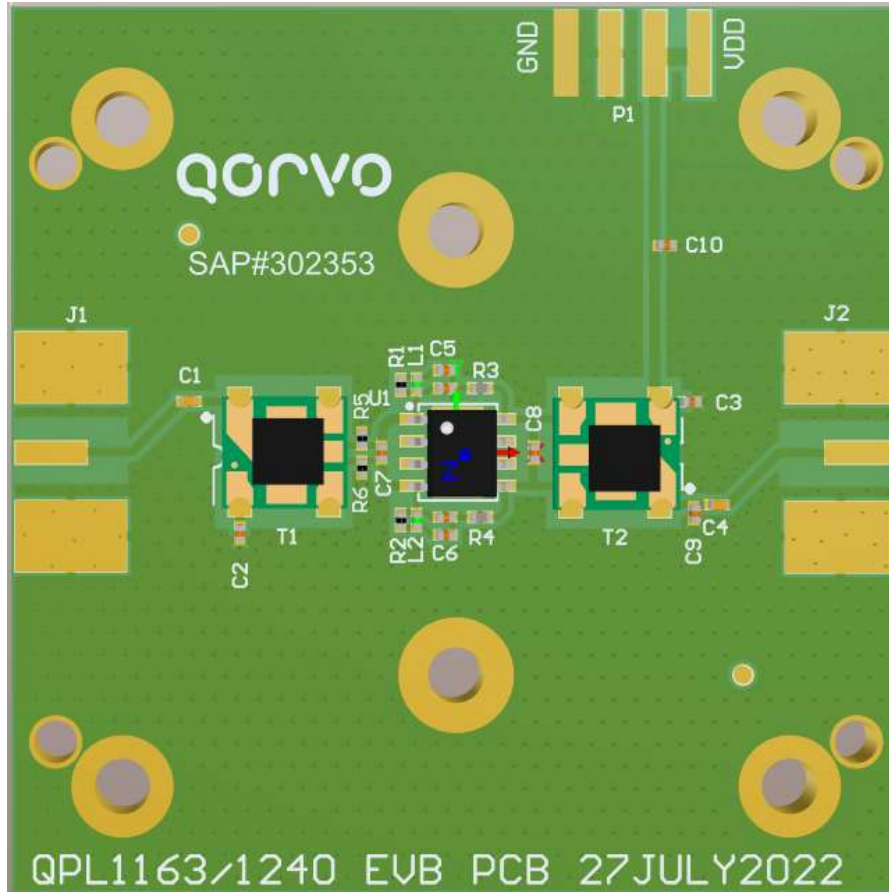

#### LAYER STACK LEGEND

Material	Layer	Thickness	Dielectric	Material Type	Comment
	TopOverlay			Legend	HIGH TEMPERATURE, NON-CONDUCTIVE, WHITE EPOXY BASED INK.
Surface Material	TopSolder	0.0004in	Solder Resist	Solder Mask	LPI (LIQUID PHOTO-IMAGEABLE), OR LDI (LASER DIRECT IMAGEABLE), GREEN. MAX FINISH THICKNESS TO BE 0.001in.
Copper	L1	0.0020in		Signal	
Core		0.0590in	Core-043	Dielectric	FR4
Copper	L2	0.0020in		Signal	
Surface Material	BottomSolder	0.0004in	Solder Resist	Solder Mask	
	BottomOverlay			Legend	
<b>Total thickness: 0.0638in</b>					

### Performance Data for Downstream (5V, 50 – 1218 MHz)

Test conditions unless otherwise noted: Vdd = +5V, Temp = +25C, Zo = 75Ω

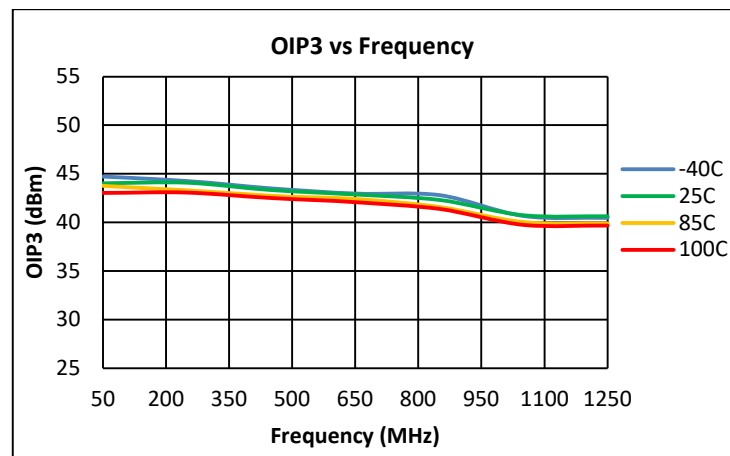
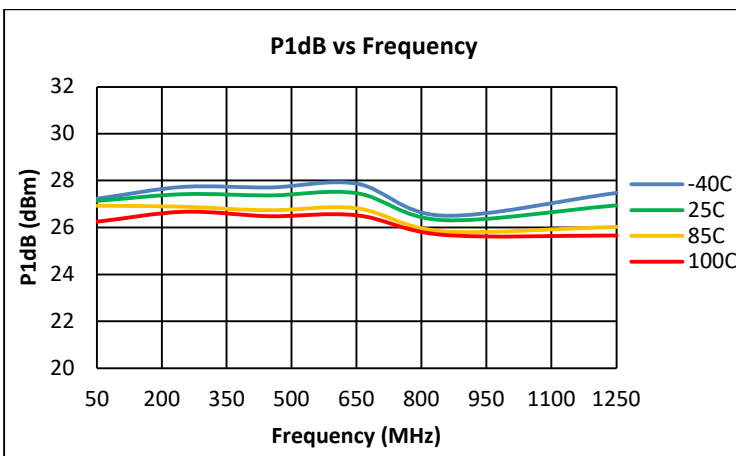
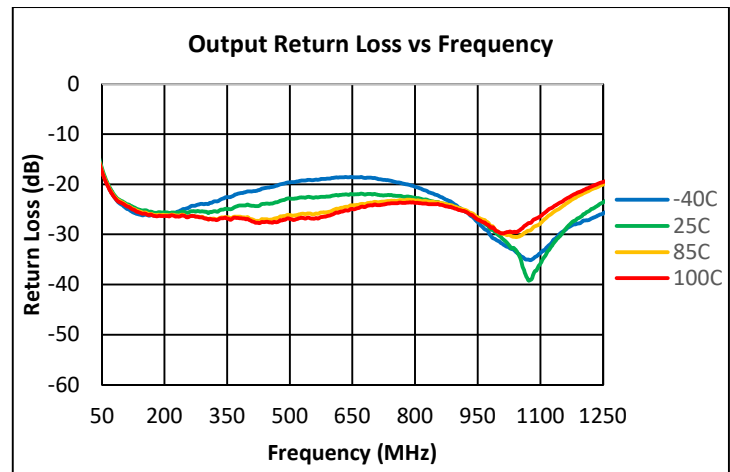
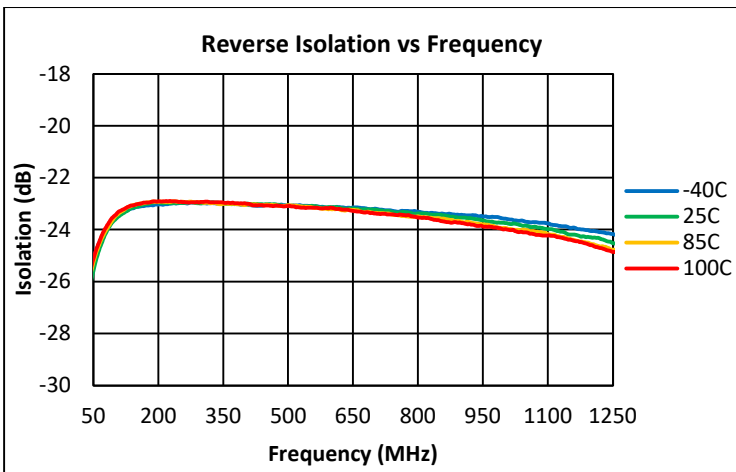
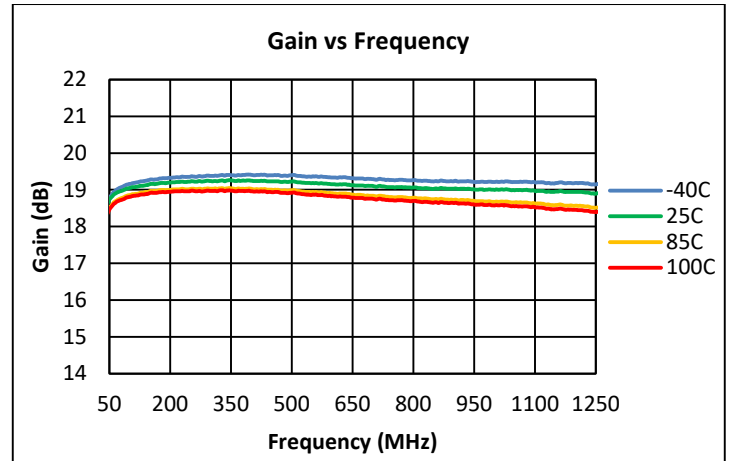
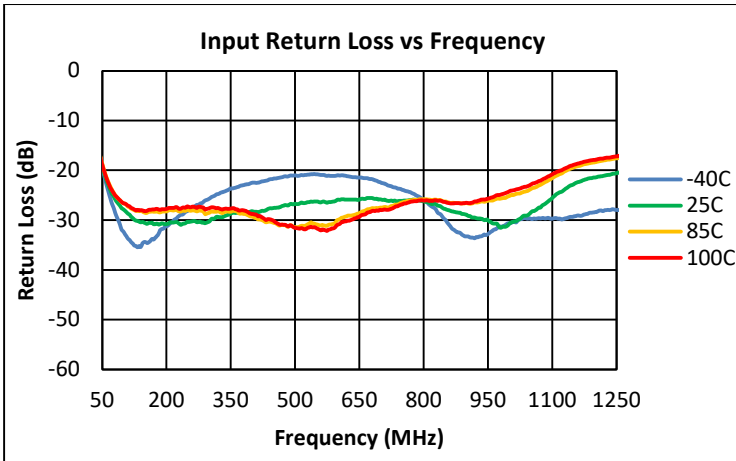

Note:

- OIP3: +12 dBm / tone output, Δf = 6 MHz, 50-1218 MHz.

### Performance Data for Downstream (5V, 50 – 1218 MHz)

Test conditions unless otherwise noted: V<sub>dd</sub> = +5V, Temp = +25C, Z<sub>o</sub> = 75Ω

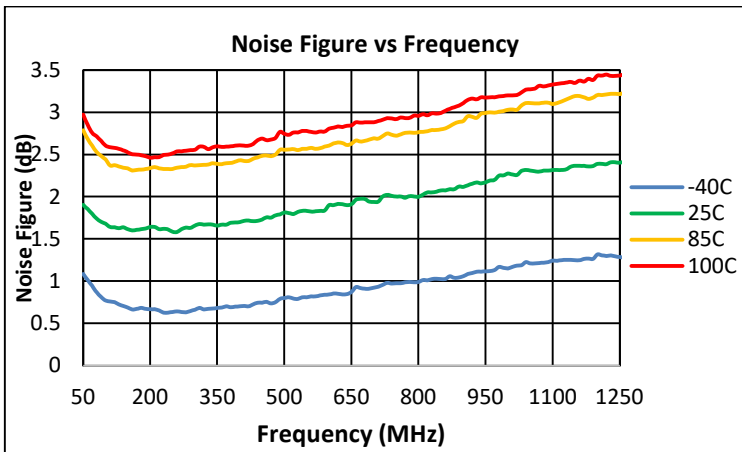
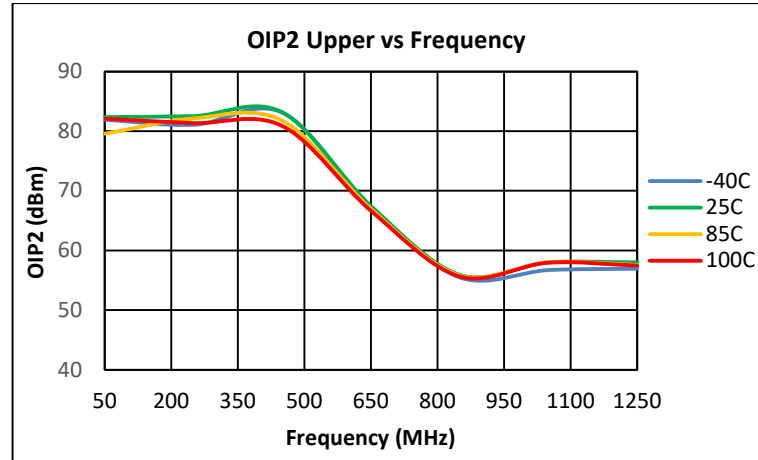
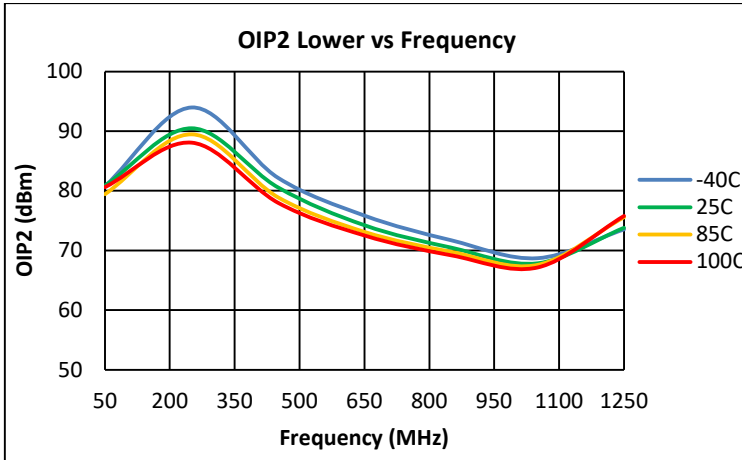

Notes:

- OIP2: +12 dBm / tone output, Δf = 53 MHz, 50-1218 MHz

### Performance Data for Downstream (5V, 50 – 1218 MHz)

Test conditions unless otherwise noted: V<sub>dd</sub> = +5V, Temp = +25C, Z<sub>o</sub> = 75Ω

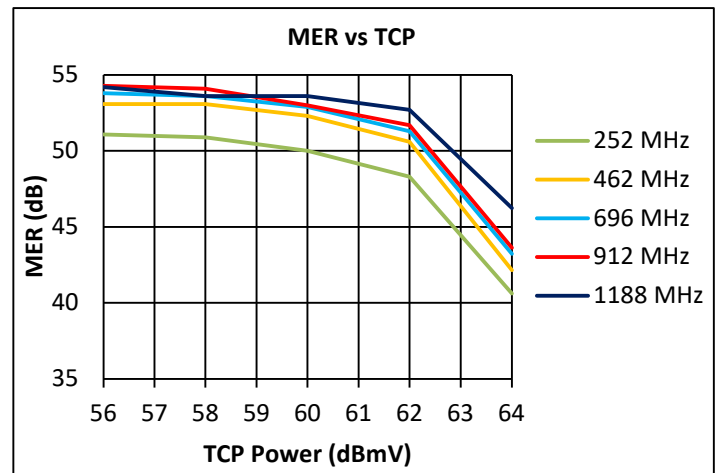
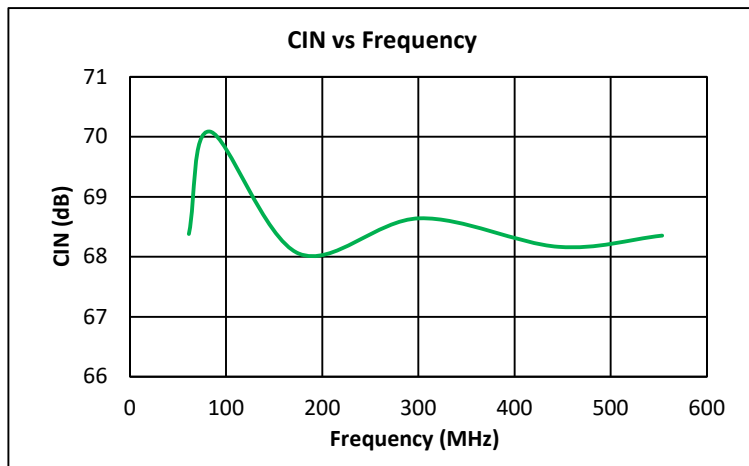
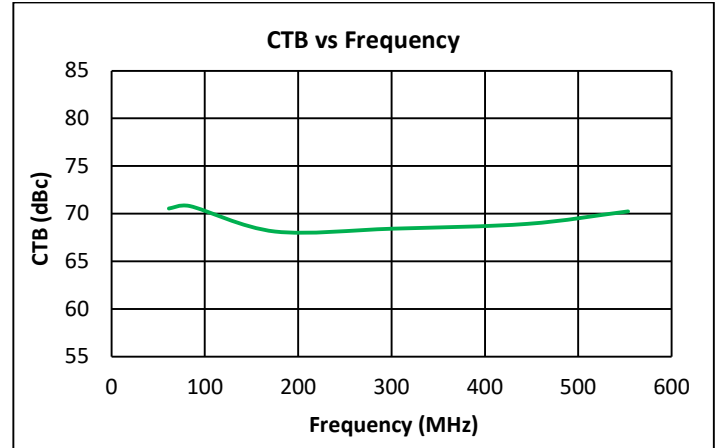
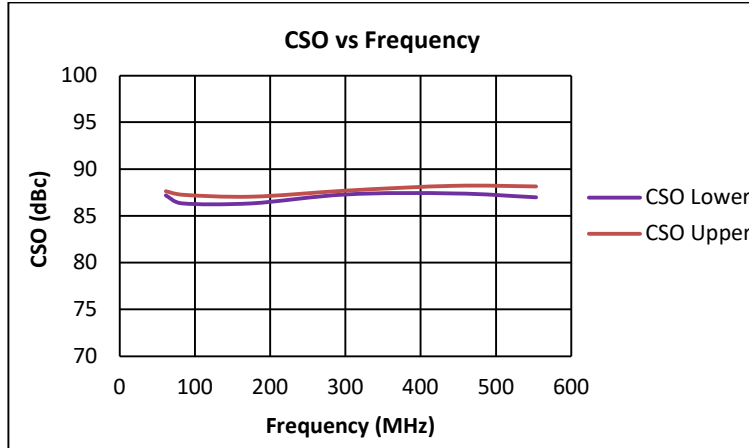

**Notes:**

1. CTB, CSO, and CIN: 79 channels + QAM to 1 GHz, 0 dB tilt, +39 dBmV per channel output
2. MER is source corrected; 10dB Tilt

### Performance Data for Downstream (8V, 50 – 1218 MHz)

Test conditions unless otherwise noted: V<sub>dd</sub> = +8V, Temp = +25C, Z<sub>o</sub> = 75Ω

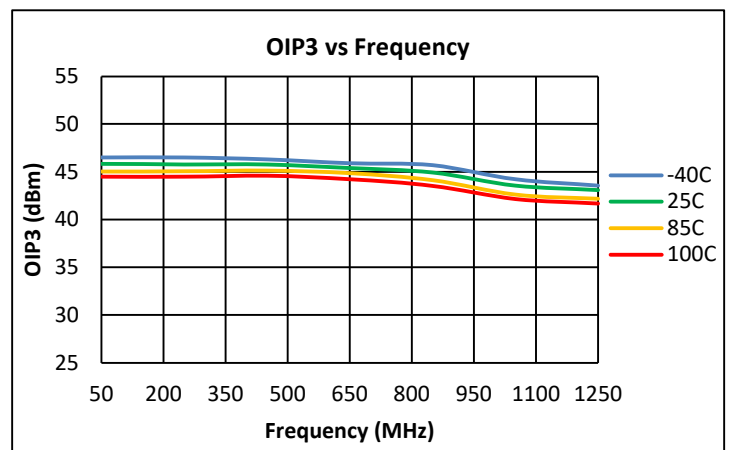
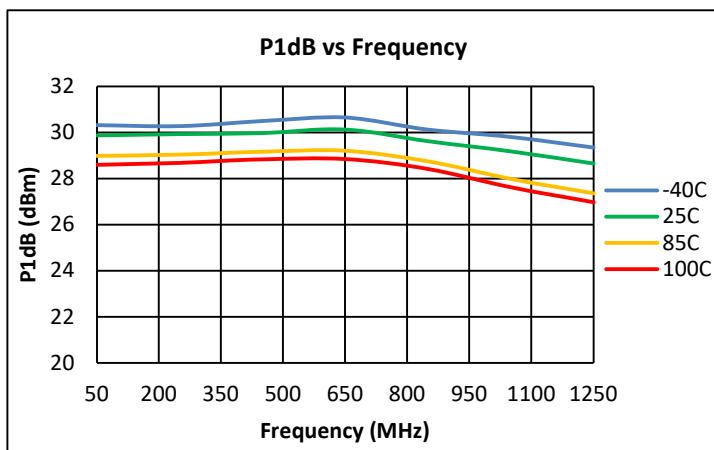
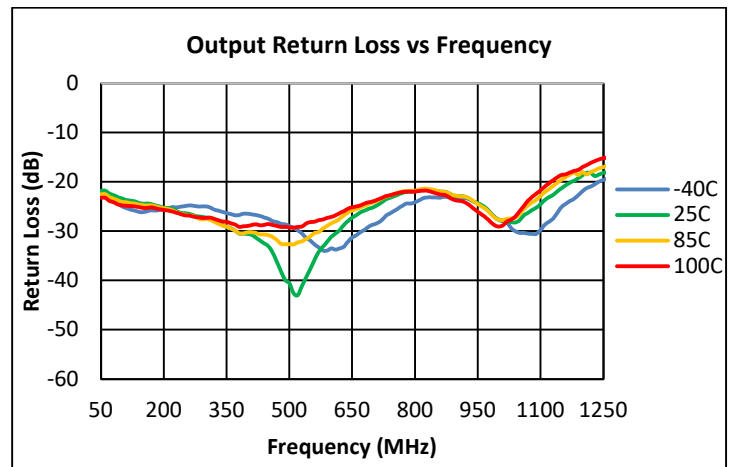
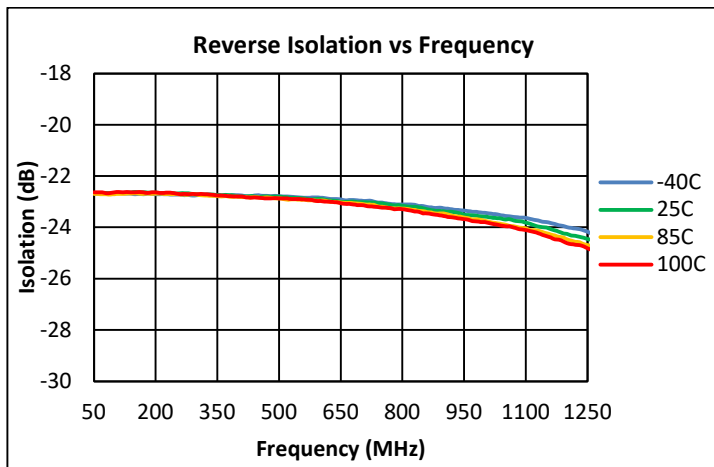
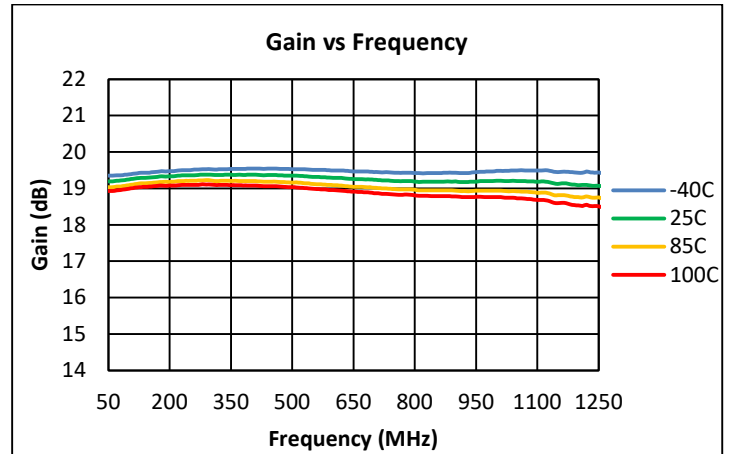
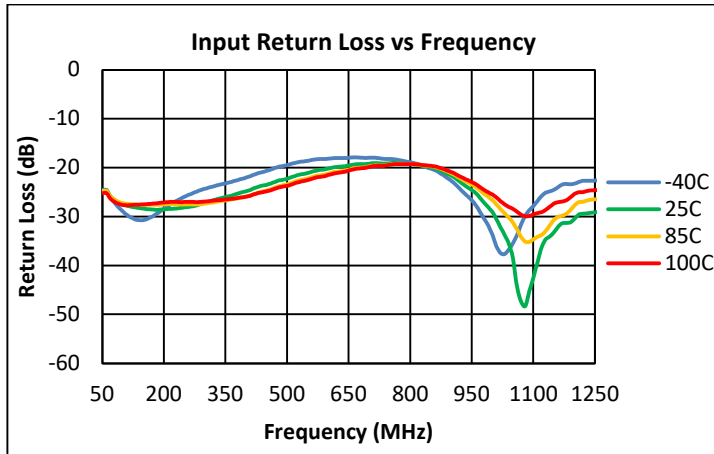

Note:

- OIP3: +12 dBm / tone output, Δf = 6 MHz, 50-1218 MHz.



### Performance Data for Downstream (8V, 50 – 1218 MHz)

Test conditions unless otherwise noted: V<sub>dd</sub> = +8V, Temp = +25C, Z<sub>o</sub> = 75Ω

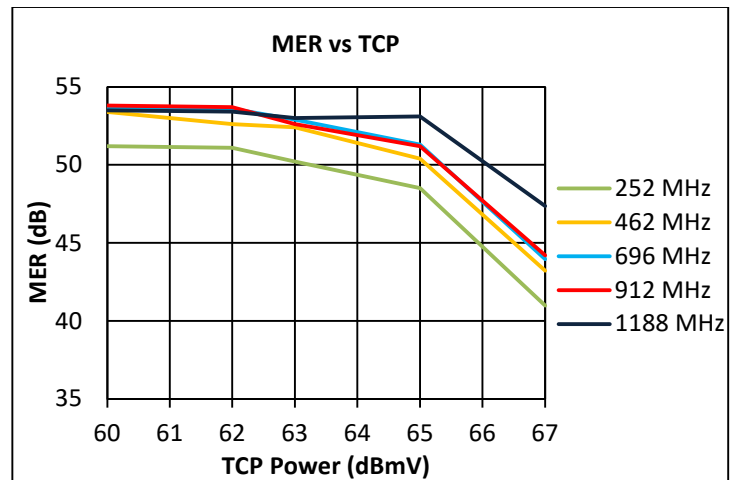
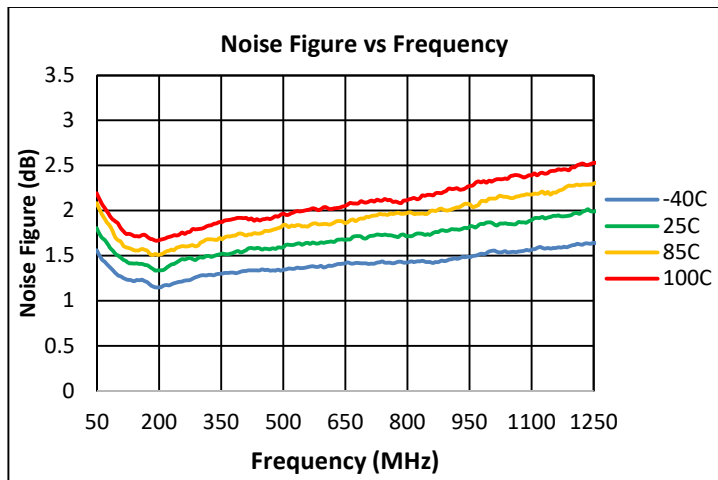
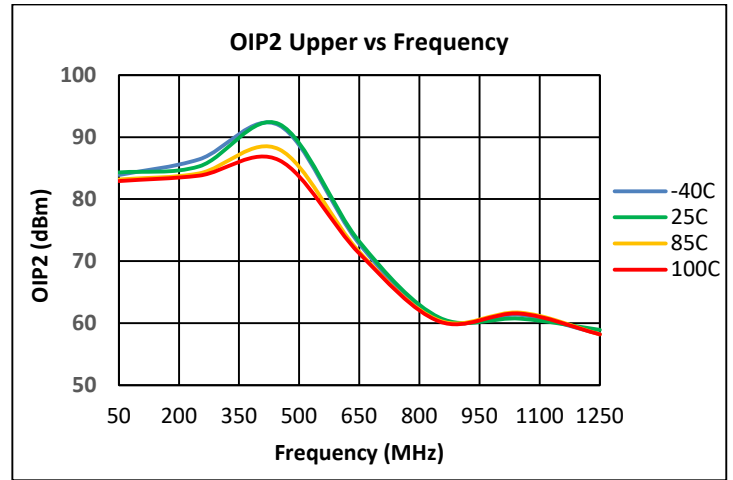
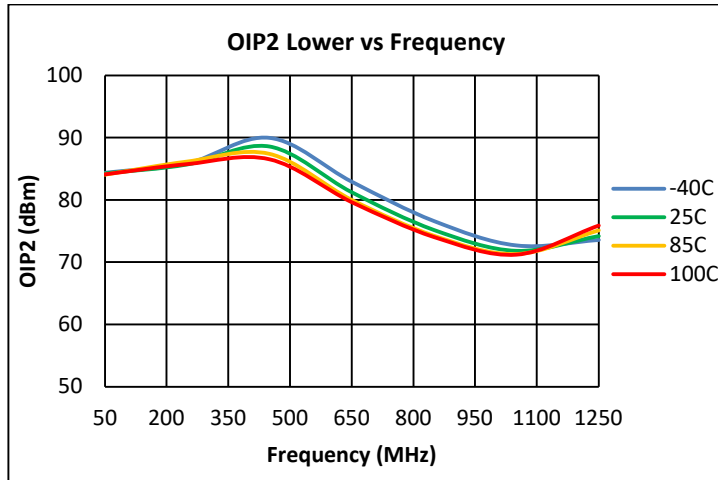

Note:

1. OIP2: +12 dBm / tone output, Δf = 53 MHz, 50-1218 MHz
2. MER is source corrected; 10dB Tilt

### Evaluation Board Schematic for Upstream (5V, 5 – 300 MHz)

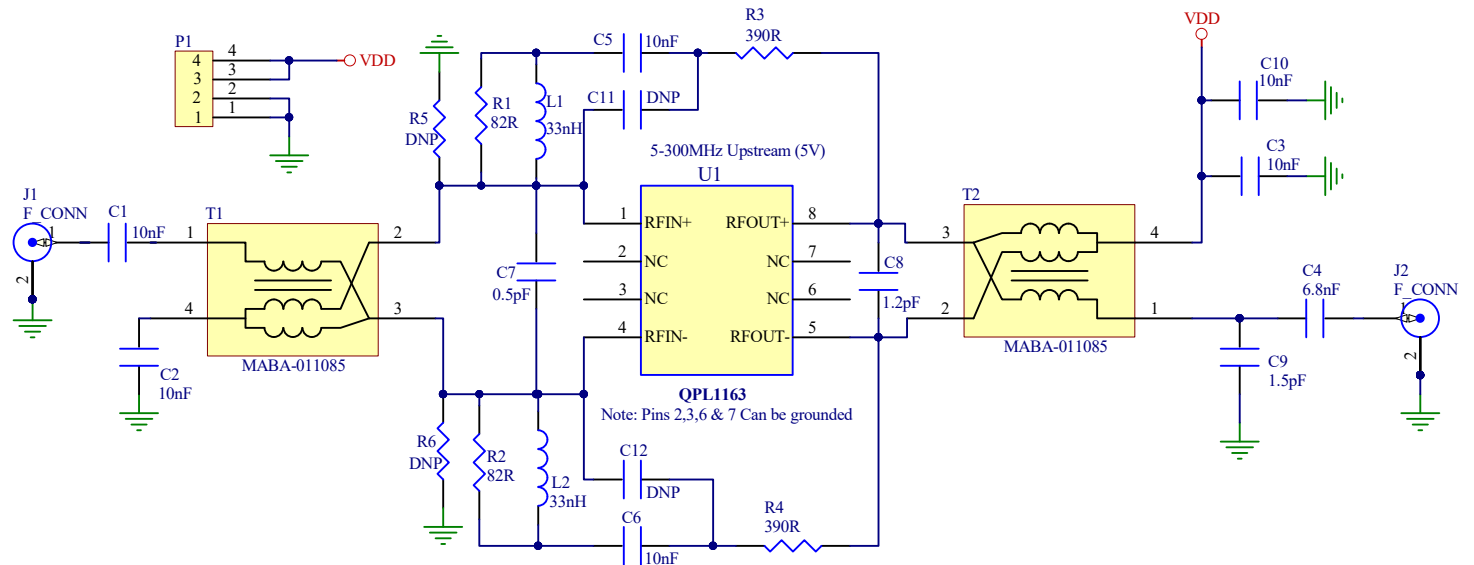

### Bill of Material for Upstream (5V, 5 – 300 MHz)

Reference Designator	Description	Manufacturer	Part Number
U1	1218 MHz, 19 dB Push-Pull Amp	Qorvo	QPL1163SB
PCB	EVB PCB, QPL1163/1240	Qorvo	SAP # 302353
C1, C2, C3, C5, C6, C10	CAP, 0.01 uF, 5 %, 50 V, 0402	Murata	GRM1555C1H103JA01D
C4	CAP, 6800pF, +/-2%, 50V, HI-Q, 0402	Murata	GRM1555C1H682GE01D
C7	CAP, 0.5pF, +/-0.25pF, 50V, HI-Q, 0402	Murata	GJM1555C1HR50CB01D
C8	CAP, 1.2pF, +/-0.25pF, 50V, HI-Q, 0402	Murata	GJM1555C1H1R2CB01D
C9	CAP, 1.5pF, +/-0.25pF, 50V, HI-Q, 0402	Murata	GJM1555C1H1R5CB01D
L1, L2	IND, 33nH, 5%, M/L, 0402	Murata	LQG15HN33NJ02D
R1, R2	RES, 82 OHM, 5%, 1/16W, 0402	Kamaya	RMC1/16S-820JTH
R3, R4	RES, 390 OHM, 5%, 1/16W, 0402	Kamaya	RMC1/16S-391JTH
T1, T2	BALUN, 1:1	MACOM	MABA-011085*
P1	CONN, HDR	Samtec	TSW-103-07-G-S
J1, J2	CONN, F FEM, 75OHM	Millimeter Wave	MW-846-C-DD-75
Heatsink	HEATSINK, 50 x 50 x10, ALUMINUM	Alpha Nova Tech	S08EFV05-A
C11, C12, R5, R6	DNP		

\* Alternate Balun: MRFXF5R09

\* For 8V operation, populate R5 & R6 with 14K Ohm Resistors

### Performance Data for Upstream (5V, 5 – 300 MHz)

Test conditions unless otherwise noted: Vdd = +5V, Temp = +25C, Zo = 75Ω

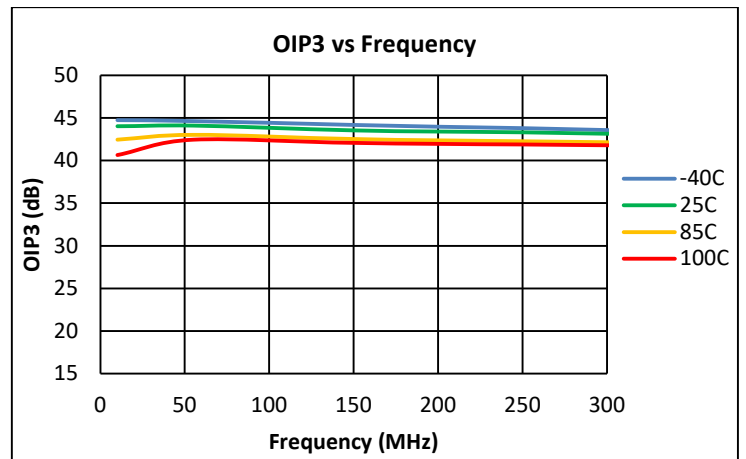
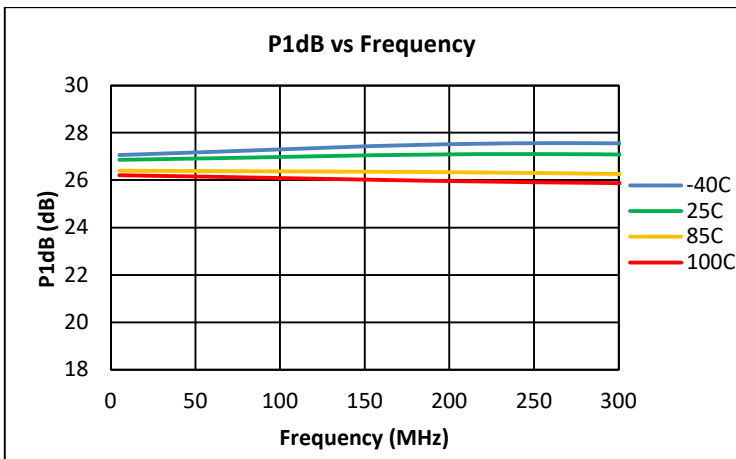
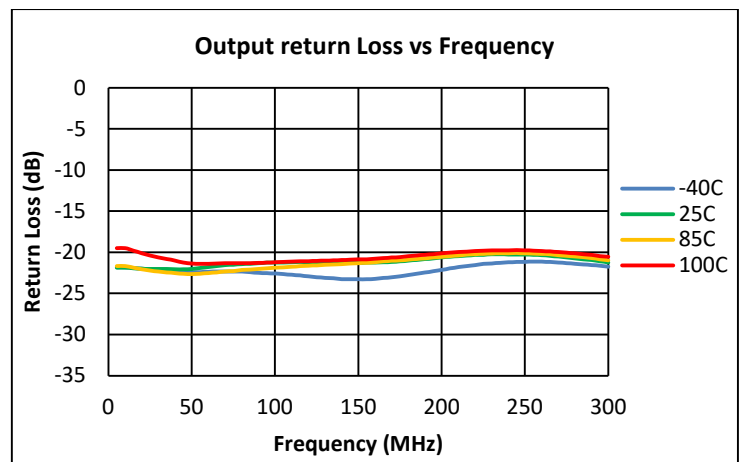
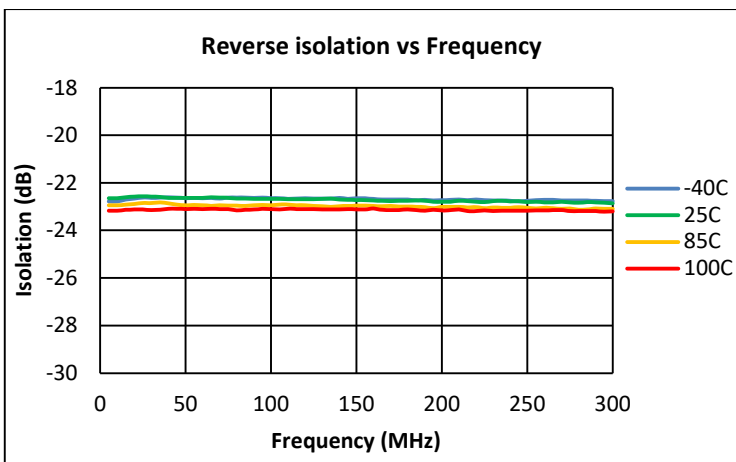
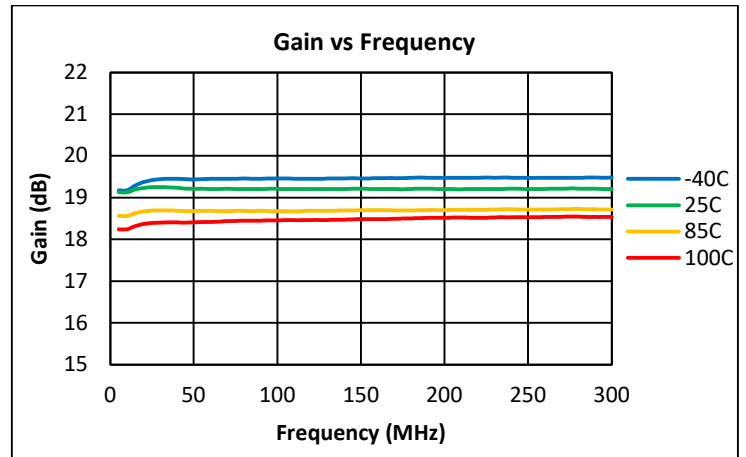
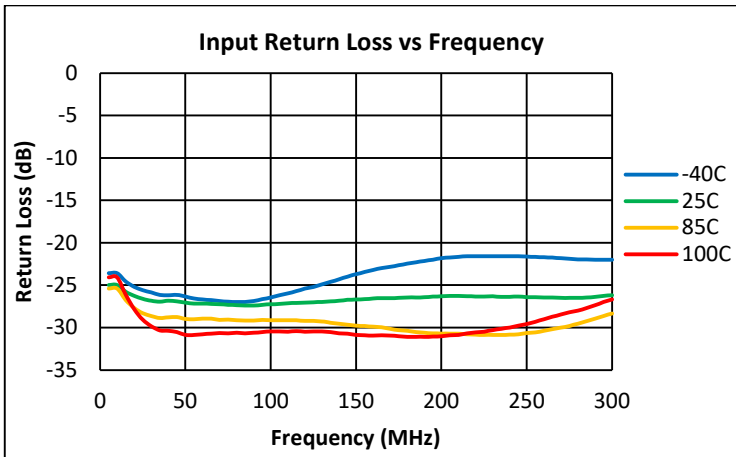

Notes:

- OIP3: +12 dBm / tone output, Δf = 6 MHz, 5-300 MHz.

### Performance Data for Upstream (5V, 5 – 300 MHz)

Test conditions unless otherwise noted: V<sub>dd</sub> = +5V, Temp = +25C, Z<sub>o</sub> = 75Ω

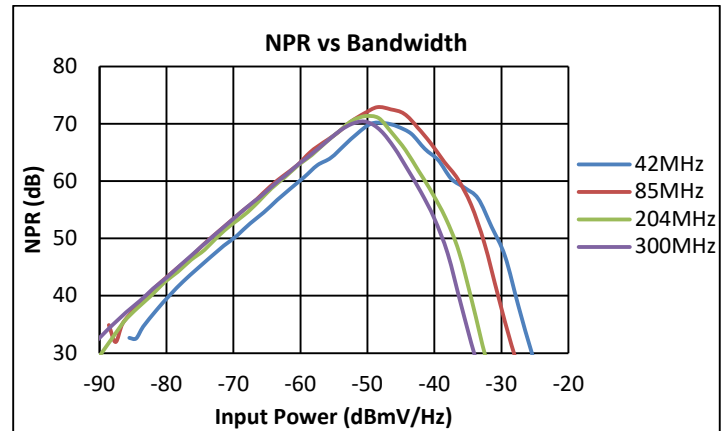
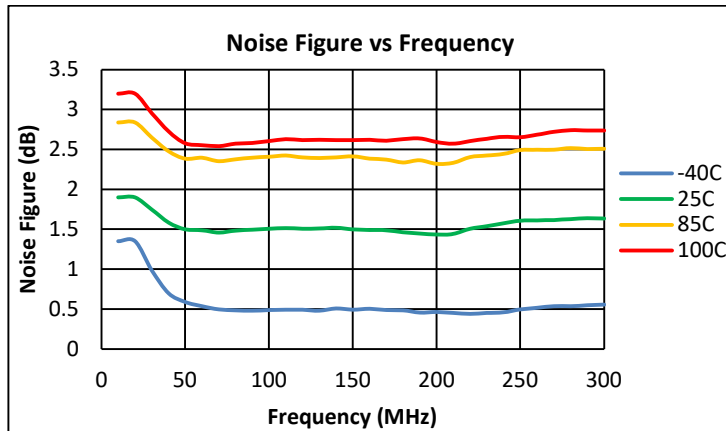
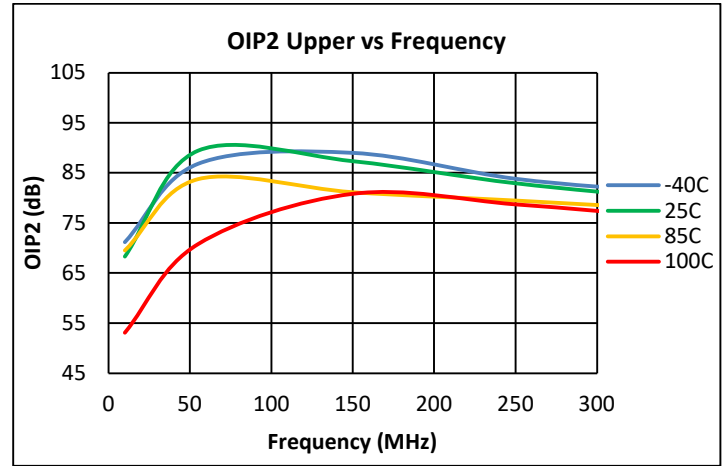
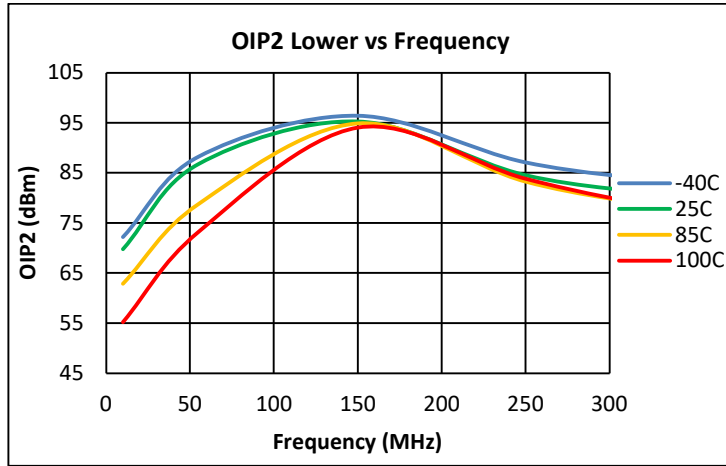

**Notes:**

- OIP2: +12 dBm / tone output, Δf = 53 MHz, 5-300 MHz.

**Electrical Specifications for Upstream (5 – 700 MHz)**

Parameter	Condition <sup>(1)</sup>	Min	Typ	Max	Unit
Supply Voltage (V <sub>DD</sub> )			5 / 8		V
Supply Current (I <sub>DD</sub> )	V <sub>DD</sub> total current		275 / 330		mA
Frequency Range		5		700	MHz
Gain	5 - 700 MHz		19		dB
Gain Flatness	5 - 700 MHz		±0.5		dB
Input Return Loss	5 - 700 MHz		20		dB
Output Return Loss	5 - 700 MHz		20		dB
Noise Figure	5 - 700 MHz		1.8		dB
OIP2	12 dBm / tone, Δf = 53 MHz, 5 - 700 MHz		80		dBm
OIP3	12 dBm / tone, Δf = 6 MHz, 5 - 700 MHz		45		dBm
Output P1dB	5 - 700 MHz		27		dBm
Thermal Resistance			20		°C/W

**Notes:**

1. Typical performance at these conditions: Temp = +25 °C, V<sub>DD</sub> = +5V, 75 Ω system, Full band unless otherwise noted.

### Evaluation Board Schematic for Upstream (5V, 5 – 700 MHz)

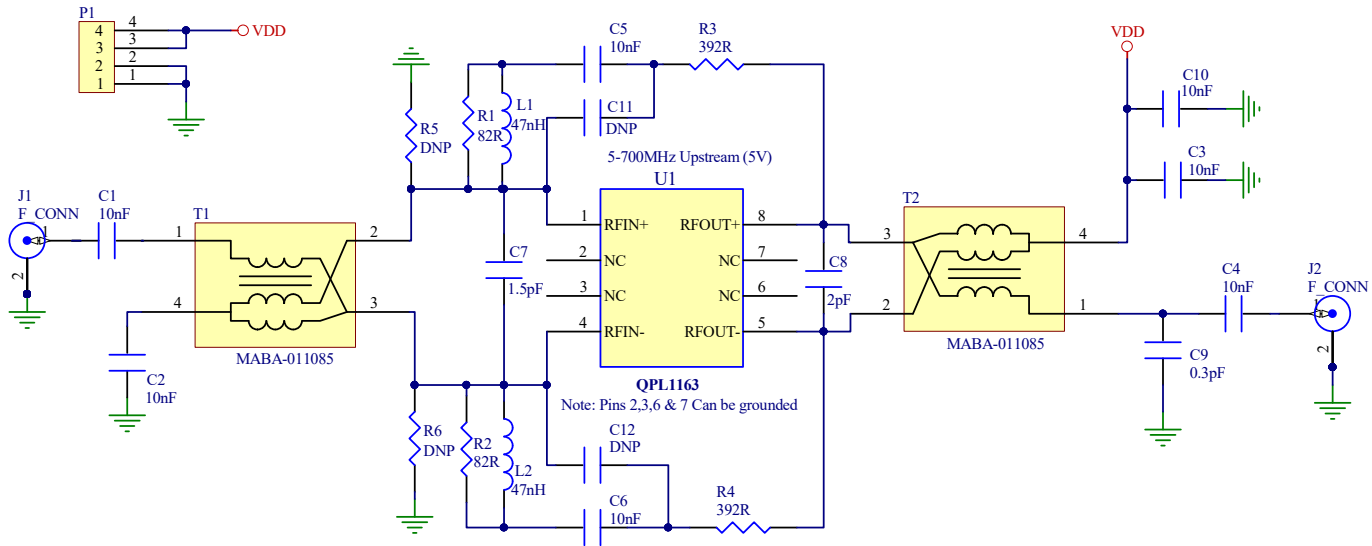

### Bill of Material for Upstream (5V, 5 – 700 MHz)

Reference Designator	Description	Manufacturer	Part Number
U1	1218 MHz, 19 dB Push-Pull Amp	Qorvo	QPL1163SB
PCB	EVB PCB, QPL1163/1240	Qorvo	SAP # 302353
C1, C2, C3, C4, C5, C6, C10	CAP, 0.01 uF, 5 %, 50 V, 0402	Murata	GRM1555C1H103JA01D
C7	CAP, 1.5pF, +/-0.25pF, 50V, HI-Q, 0402	Murata	GJM1555C1H1R5CB01D
C8	CAP, 2pF, +/-0.25pF, 50V, HI-Q, 0402	Murata	GJM1555C1H2R0CB01D
C9	CAP, 0.3pF, +/-0.25pF, 50V, HI-Q, 0402	Murata	GJM1555C1HR30CB01D
L1, L2	IND, 47nH, 5%, M/L, 0402	Murata	LQG15HN47NJ02D
R1, R2	RES, 82 OHM, 5%, 1/16W, 0402	Kamaya	RMC1/16S-820JTH
R3, R4	RES, 392 OHM, 5%, 1/10W, 0402	Kamaya	RMC1/16SK3920FTH
T1, T2	BALUN, 1:1	MACOM	MABA-011085
P1	CONN, HDR	Samtec	TSW-103-07-G-S
J1, J2	CONN, F FEM, 75OHM	Millimeter Wave	MW-846-C-DD-75
Heatsink	HEATSINK, 50 x 50 x10, ALUMINUM	Alpha Nova Tech	S08EFV05-A
C11, C12, R5, R6	DNP		

\*For 8V operation, populate R5 & R6 with 14K Ohm Resistors

### Performance Data for Upstream (5V, 5 – 700 MHz)

Test conditions unless otherwise noted: V<sub>dd</sub> = +5V, Temp = +25C, Z<sub>o</sub> = 75Ω

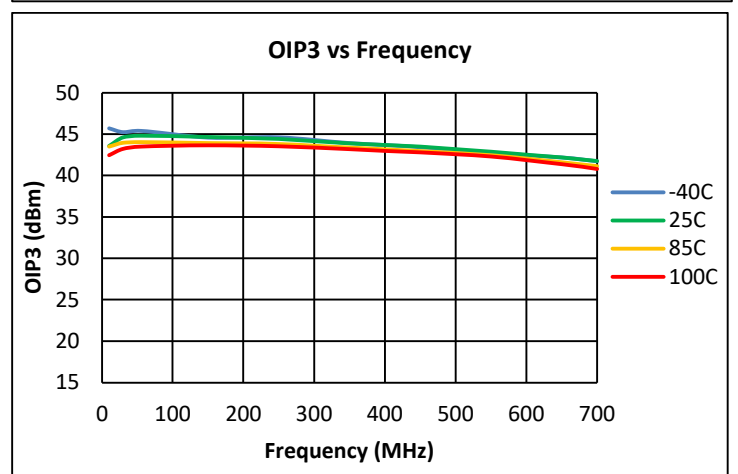
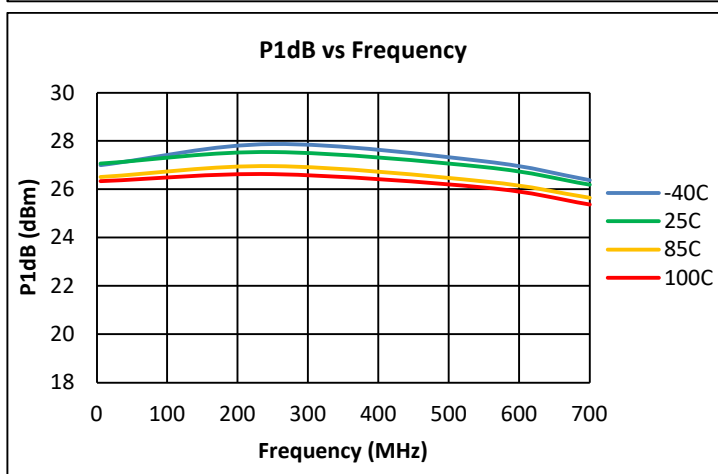
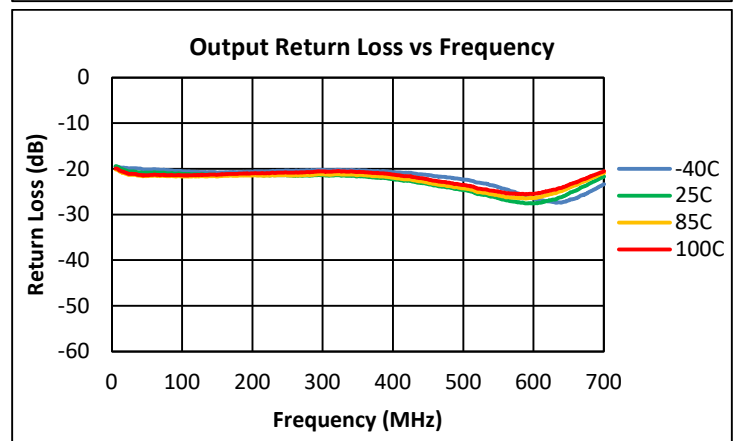
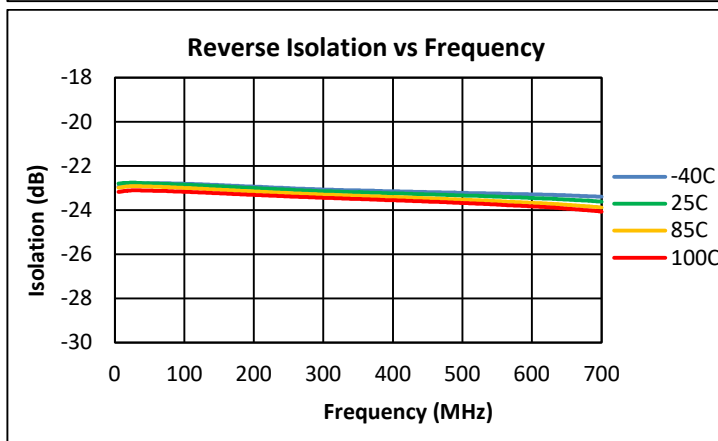
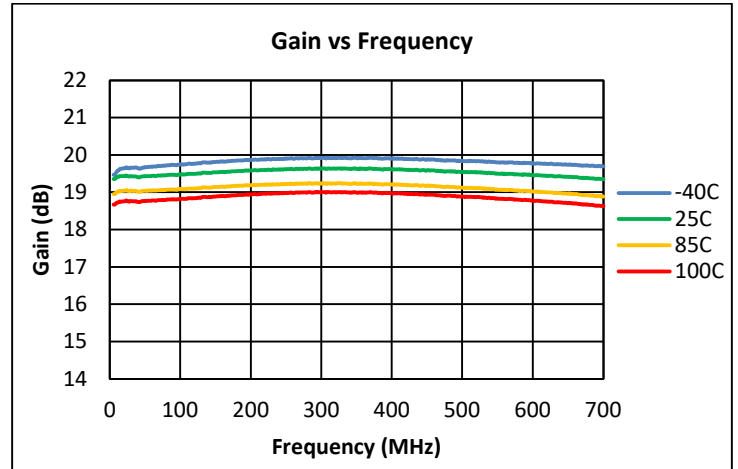
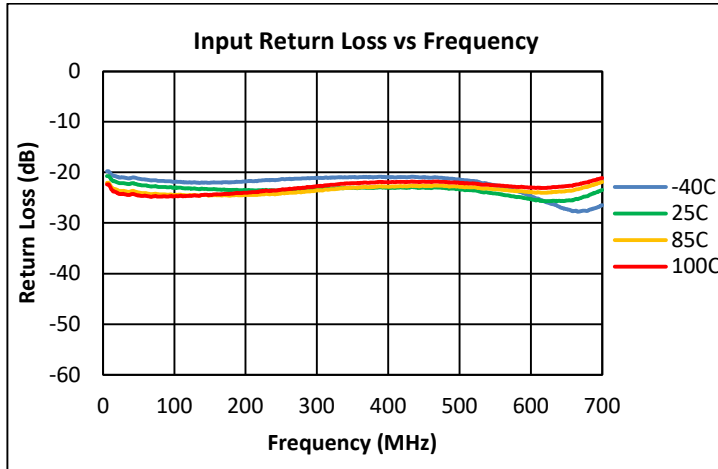

Notes:

- OIP3: +12 dBm / tone output, Δf = 6 MHz, 5-700 MHz.

### Performance Data for Upstream (5V, 5 – 700 MHz)

Test conditions unless otherwise noted: V<sub>dd</sub> = +5V, Temp = +25C, Z<sub>o</sub> = 75Ω

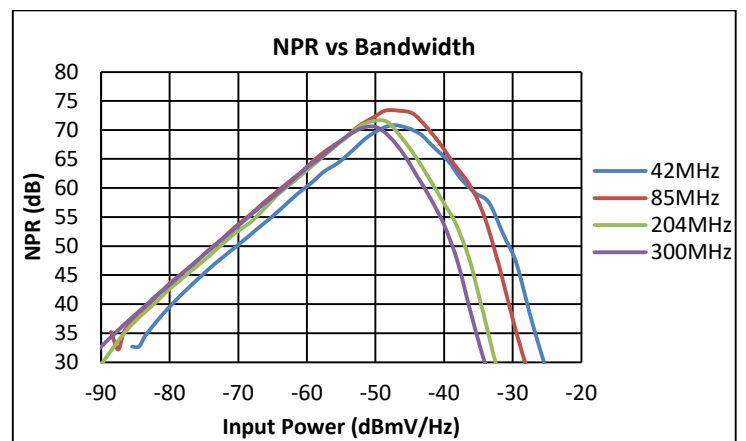
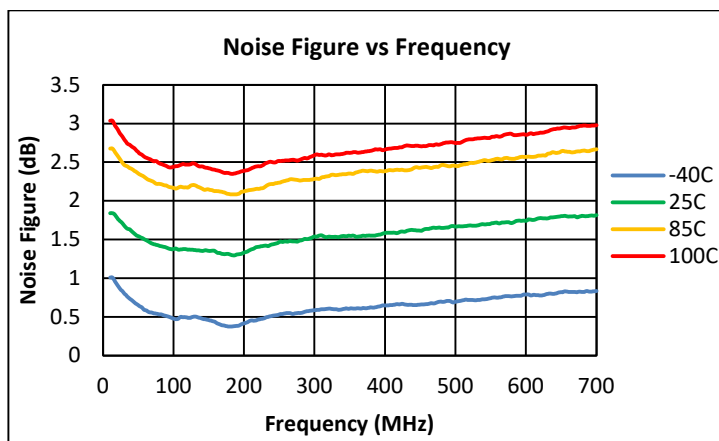
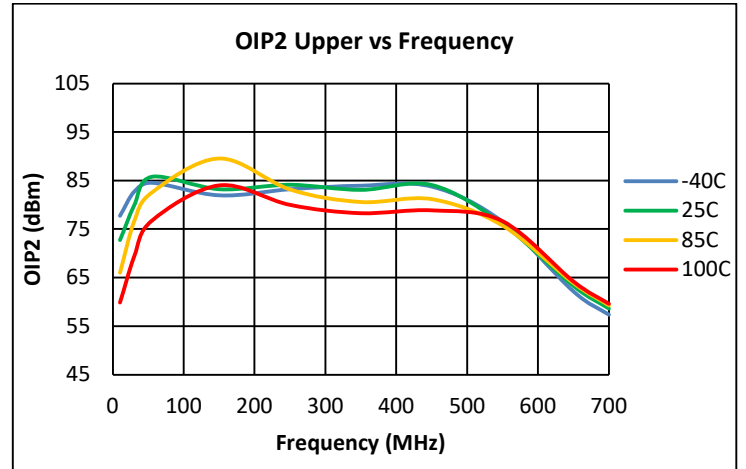
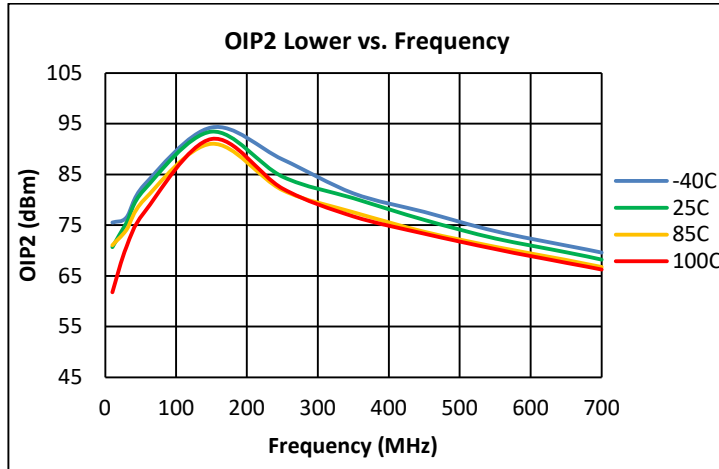

Notes:

1. OIP2: +12 dBm / tone output, Δf = 53 MHz, 5-700 MHz



### Performance Data for Upstream (8V, 5 – 700 MHz)

Test conditions unless otherwise noted: V<sub>dd</sub> = +8V, Temp = +25C, Z<sub>o</sub> = 75Ω

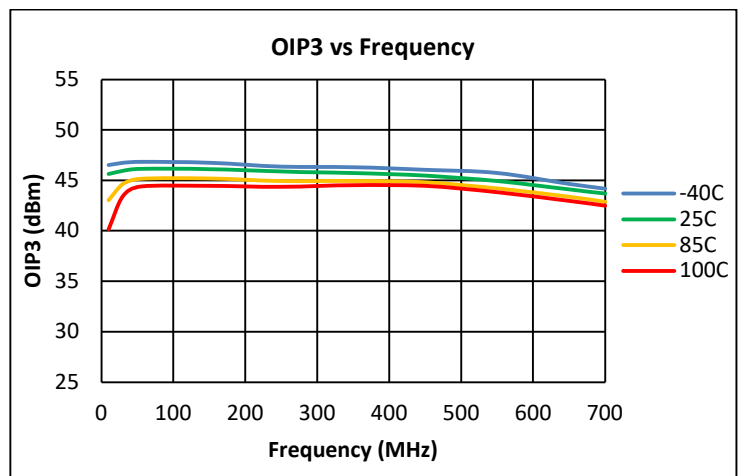
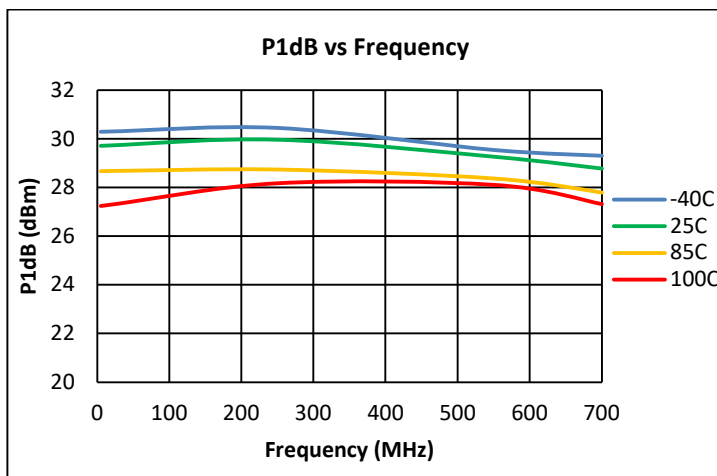
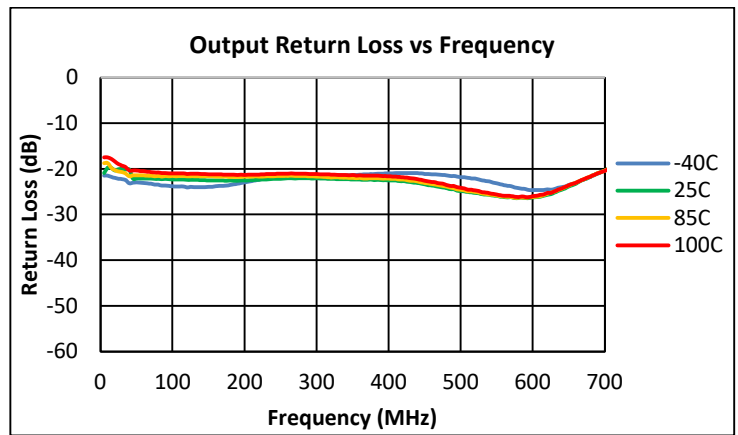
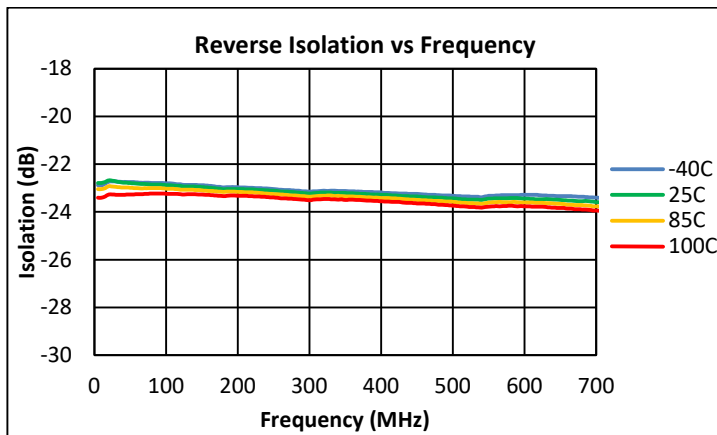
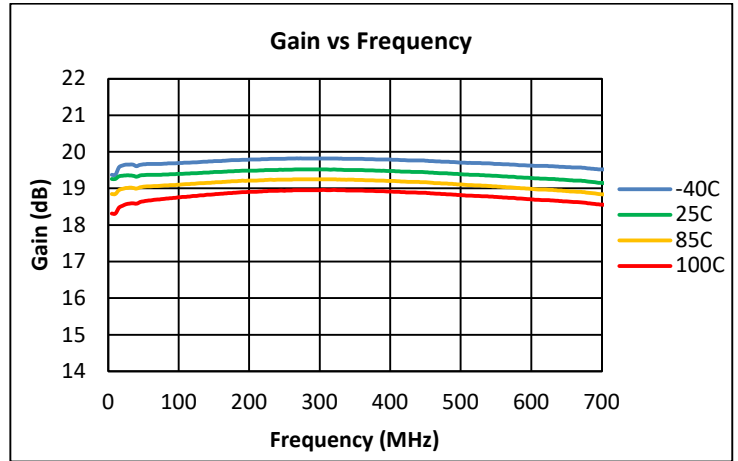
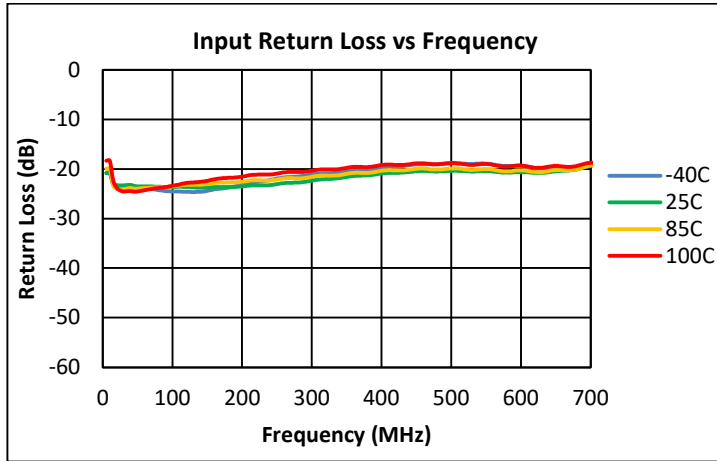

Notes:

- OIP3: +12 dBm / tone output, Δf = 6 MHz, 5-700 MHz.

### Performance Data for Upstream (8V, 5 – 700 MHz)

Test conditions unless otherwise noted: V<sub>dd</sub> = +8V, Temp = +25C, Z<sub>o</sub> = 75Ω

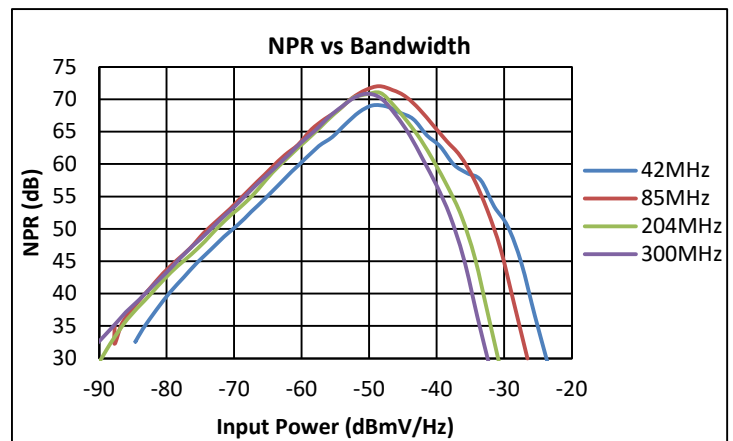
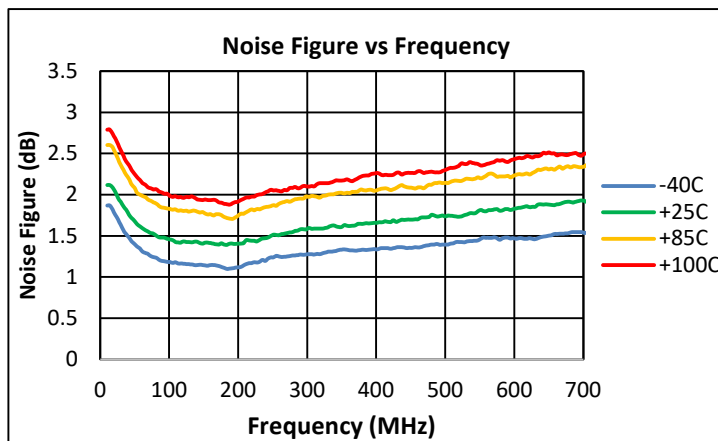
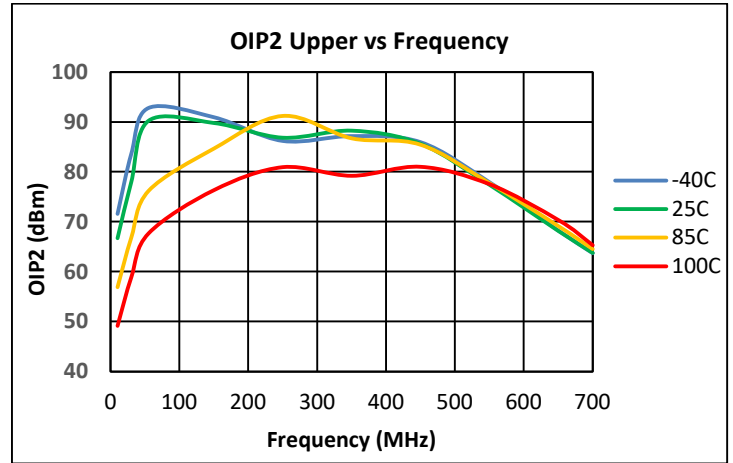
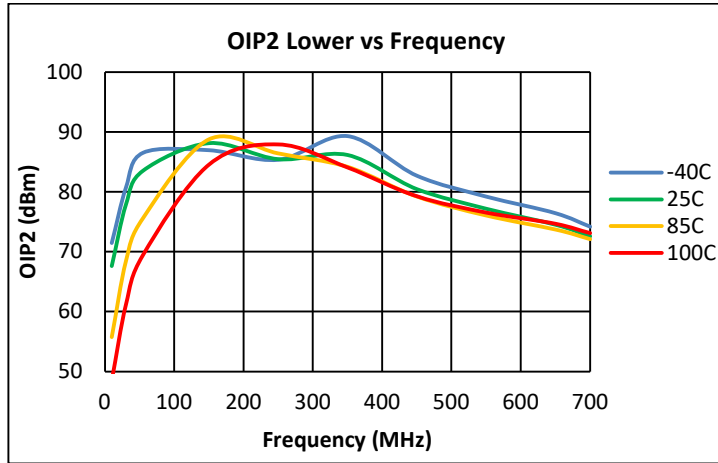

Notes:  
 OIP2: +12 dBm / tone output, Δf = 53 MHz, 5-700 MHz

## Pin Configuration and Description

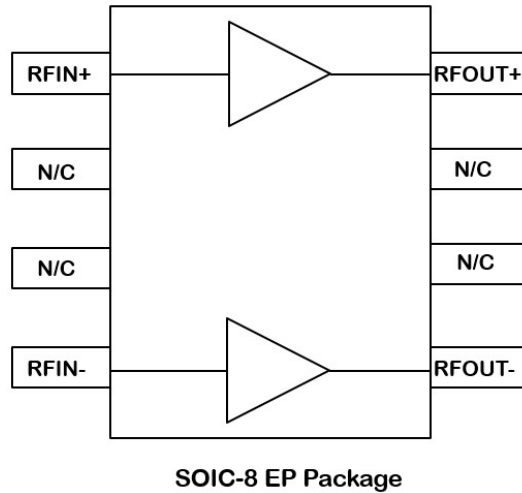

Pin	Name	Description
1	RFIN+	RF input for plus side of amplifier
2	N/C	No Internal Connection (Pin can be grounded)
3	N/C	No Internal Connection (Pin can be grounded)
4	RFIN-	RF input for minus side of amplifier
5	RFOUT-	RF output for minus side of amplifier, Vdd (requires bias choke)
6	N/C	No Internal Connection (Pin can be grounded)
7	N/C	No Internal Connection (Pin can be grounded)
8	RFOUT+	RF output for plus side of amplifier, Vdd (requires bias choke)
Slug	GND	RF, DC, and Thermal Ground

#### Package Marking

---

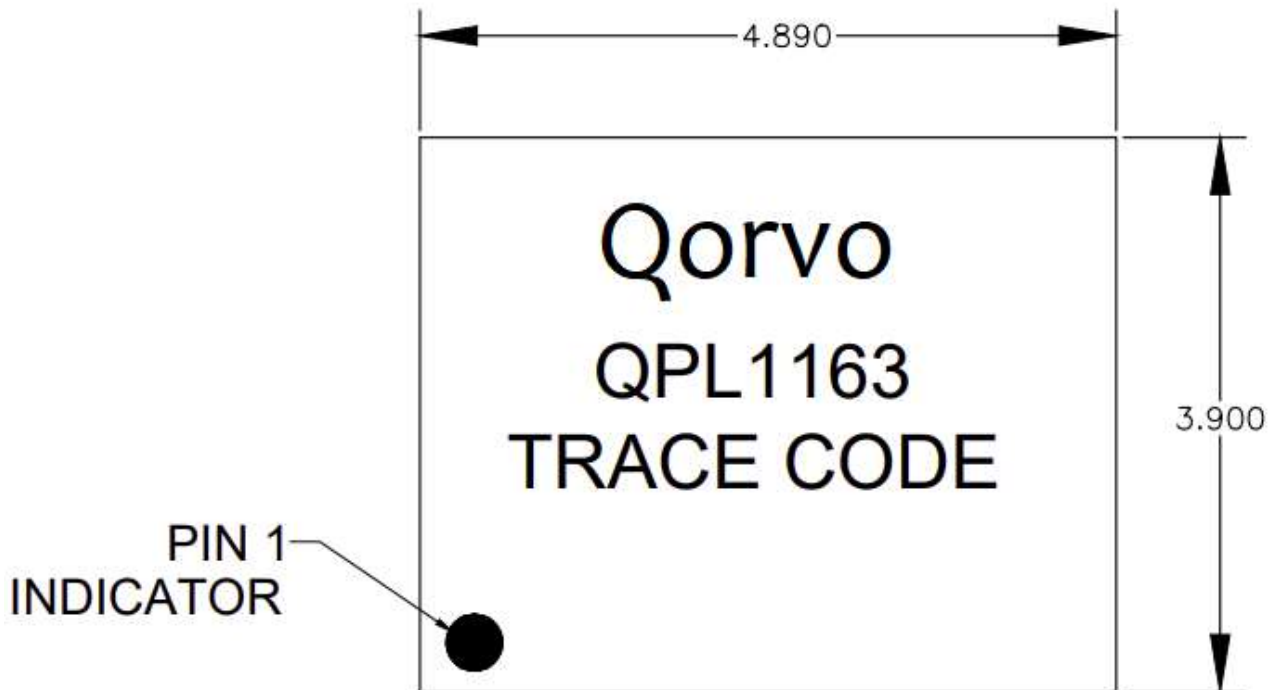

#### NOTES:

LINE 1: QPL1163

LINE 2: TRACE CODE.

TRACE CODE TO BE  
ASSIGNED BY SUBCON.

