

Product Overview

The QPL1163 is an ultra-linear GaAs pHEMT 75-Ohm differential amplifier IC with 5–1218 MHz operating bandwidth. This amplifier provides 19dB of gain and very low noise figure. The Differential push-pull topology provides excellent 2nd order intermodulation performance. The QPL1163 can be used as a low noise balanced amp in DOCSIS downstream, as well as upstream applications, due to its wide operational bandwidth. The QPL1163 is packaged in a SOIC-8 plastic package.



8-Pin SOIC Package

Functional Block Diagram

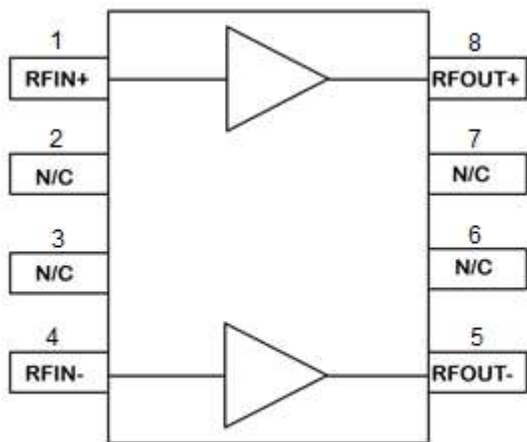

SOIC-8 EP Package

Key Features

- High Gain: 19dB at 1218 MHz
- 5–1218 MHz BW
- OIP3: +42 dBm, Downstream 50–1218 MHz
- OP1dB: 26 dBm, Downstream 50–1218 MHz
- Low Noise Figure: < 2.4 dB, Full Band
- Excellent Composite Distortion
- pHEMT GaAs device technologies
- Compact Size: 8-pin SOIC
- 5 to 8V supply voltage operation

Applications

- DOCSIS 3.1 Systems
- Balanced Antenna Applications
- HFC Optical Nodes
- 75 Ω Amplifiers
- Upstream Amplifier for DOCSIS 3.1 and DOCSIS 4.0 Applications

Ordering Information

Part Number	Description
QPL1163SB	Sample bag with 5 pieces
QPL1163SR	7" Reel with 100 pieces
QPL1163TR13	13" Reel with 2500 pieces
QPL1163EVB-01	5V, 50 – 1218 MHz Eval Board
QPL1163EVB-02	5V, 5 – 700 MHz Eval Board
QPL1163EVB-03	8V, 50 – 1218 MHz Eval Board
QPL1163EVB-04	8V, 5 – 700 MHz Eval Board

Absolute Maximum Ratings

Parameter	Rating
Supply Voltage (V_{DD})	+10 V
Supply Current (I_{DD})	400 mA
Maximum Input Level	+15 dBm
Operating Temperature Range	-40 to +100 °C
Storage Temperature Range	-40 to +150 °C
Maximum Junction Temperature	+150 °C

Exceeding any one or a combination of the Absolute Maximum Rating conditions may cause permanent damage to the device. Extended application of Absolute Maximum Rating conditions to the device may reduce device reliability.

Electrical Specifications for Downstream (50 – 1218 MHz)

Parameter	Condition ⁽¹⁾	Min	Typ	Max	Unit
Supply Voltage (V_{DD})			5 / 8		V
Supply Current (I_{DD})	V_{DD} total current		275 / 330		mA
Frequency Range		50		1218	MHz
Gain	50 – 1218 MHz		19		dB
Gain Flatness	50 – 1218 MHz		±0.5		dB
Input Return Loss	50 – 1218 MHz		20		dB
Output Return Loss	50 – 1218 MHz		20		dB
Noise Figure	50 MHz 1218 MHz		1.8 2.4		dB
CSO	79 Ch, 0dB tilt, +39dBmV / Ch Output, QAM to 1000 MHz, Downstream		86		dBc
CTB			68		dBc
CIN			68		dB
OIP2	+12 dBm / tone, $\Delta f = 53$ MHz, 50-1218 MHz		62		dBm
OIP3	+12 dBm / tone, $\Delta f = 6$ MHz, 50-1218 MHz		41		dBm
Output P1dB	50 – 1218 MHz		27		dBm
Thermal Resistance			20		°C/W

Notes:

1. Typical performance at these conditions: Temp = +25 °C, $V_{DD} = +5V$, 75 Ω system, Full band unless otherwise noted.
2. Downstream (Forward Path) Freq Range is 50-1218 MHz

Evaluation Board Schematic for Downstream (5V, 50 – 1218 MHz)

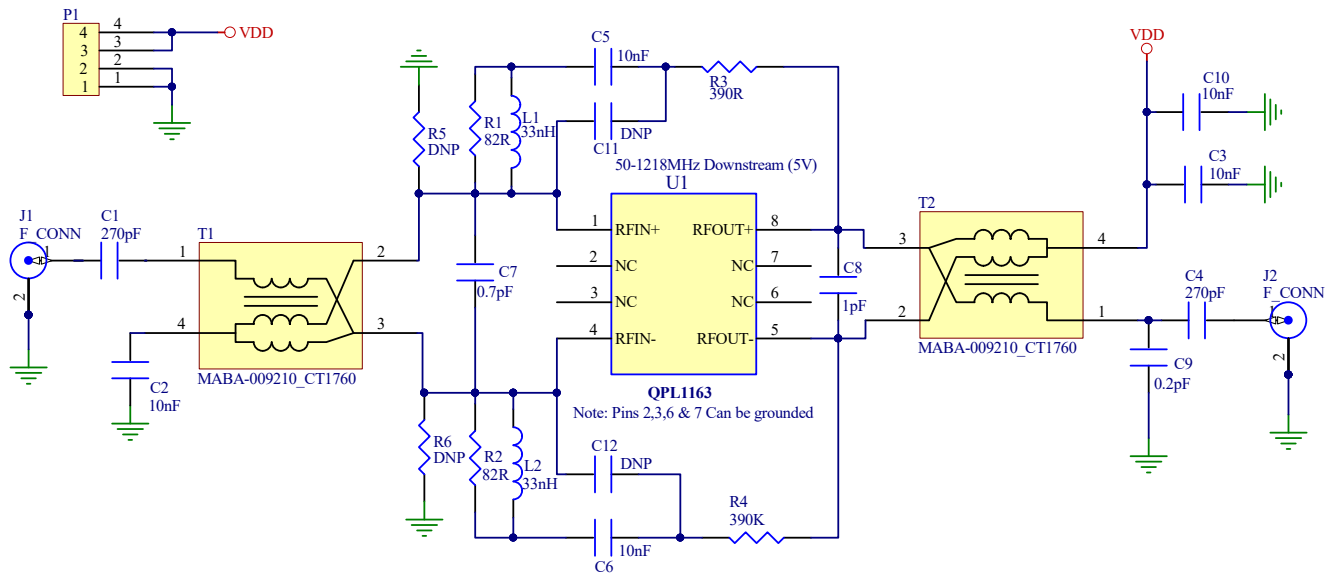

Bill of Material for Downstream (5V, 50 – 1218MHz)

Reference Designator	Description	Manufacturer	Part Number
U1	1218 MHz, 19 dB Push-Pull Amp	Qorvo	QPL1163SB
PCB	EVB PCB, QPL1163/1240	Qorvo	SAP # 302353
C1, C4	CAP, 270 pF, 5 %, 0402	Murata	GCM1555C1H271JA16D
C2, C3, C5, C6, C10	CAP, 0.01 uF, 5 %, 50 V, 0402	Murata	GRM1555C1H103JA01D
C7	CAP, 0.7pF, ±0.05pF, 50V, HI-Q, 0402	Murata	GJM1555C1HR70WB01D
C8	CAP, 1pF, +/-0.05pF, 50V, HI-Q, 0402	Murata	GJM1555C1H1R0WB01D
C9	CAP, 0.2pF, +/-0.1pF, 50V, HI-Q, 0402	Murata	GJM1555C1HR20BB01D
L1, L2	IND, 33nH, 5%, M/L, 0402	Murata	LQG15HN33NJ02D
R1, R2	RES, 82 OHM, 5%, 1/16W, 0402	Kamaya	RMC1/16S-820JTH
R3, R4	RES, 390 OHM, 5%, 1/16W, 0402	Kamaya	RMC1/16S-391JTH
T1, T2	BALUN, 1:1	MACOM	MABA-009210-CT1760*
P1	CONN, HDR	Samtec	TSW-103-07-G-S
J1, J2	CONN, F FEM, 75OHM	Millimeter Wave	MW-846-C-DD-75
Heatsink	HEATSINK, 50 x 50 x10, ALUMINUM	Alpha Nova Tech	S08EFV05-A
C11, C12, R5, R6	DNP		

* Alternate balun: MRFXF0072

* For 8V operation, populate R5 and R6 with 12K Ohm Resistors

Evaluation Board Layout

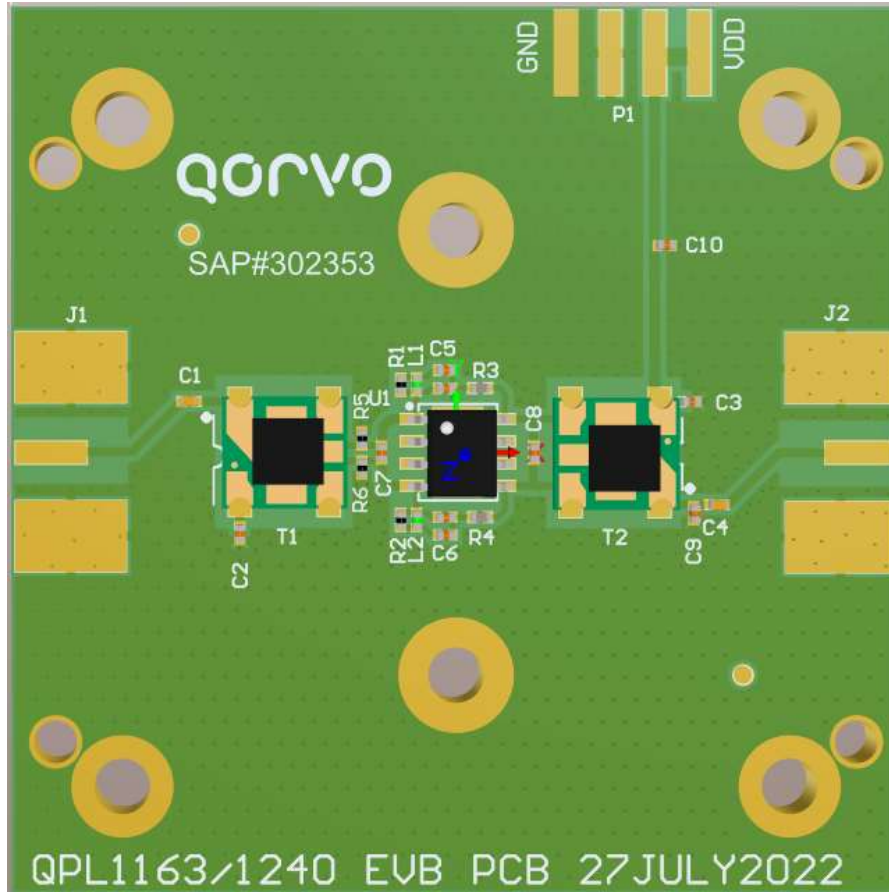

LAYER STACK LEGEND

Material	Layer	Thickness	Dielectric	Material Type	Comment
	TopOverlay			Legend	HIGH TEMPERATURE, NON-CONDUCTIVE, WHITE EPOXY BASED INK.
Surface Material	TopSolder	0.0004in	Solder Resist	Solder Mask	LPI (LIQUID PHOTO-IMAGEABLE), OR LDI (LASER DIRECT IMAGEABLE), GREEN. MAX FINISH THICKNESS TO BE 0.001in.
Copper	L1	0.0020in		Signal	
Core		0.0590in	Core-043	Dielectric	FR4
Copper	L2	0.0020in		Signal	
Surface Material	BottomSolder	0.0004in	Solder Resist	Solder Mask	
	BottomOverlay			Legend	
Total thickness: 0.0638in					

Performance Data for Downstream (5V, 50 – 1218 MHz)

Test conditions unless otherwise noted: V_{dd} = +5V, Temp = +25C, Z_o = 75Ω

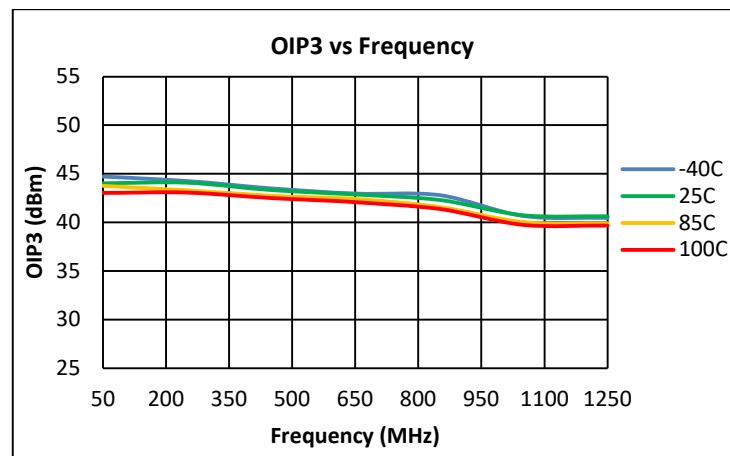
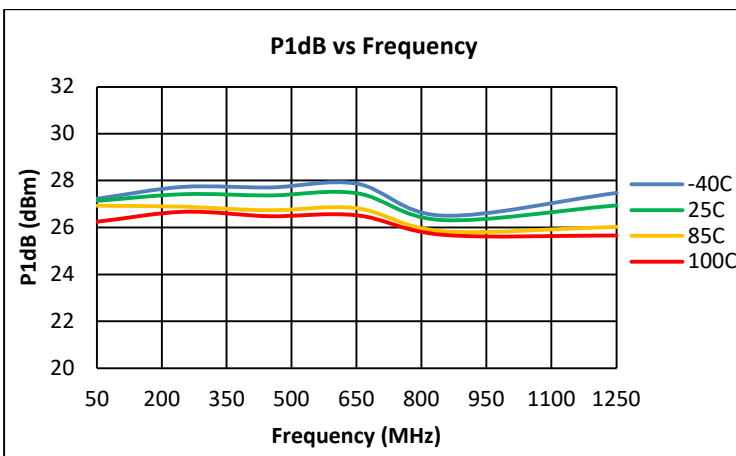
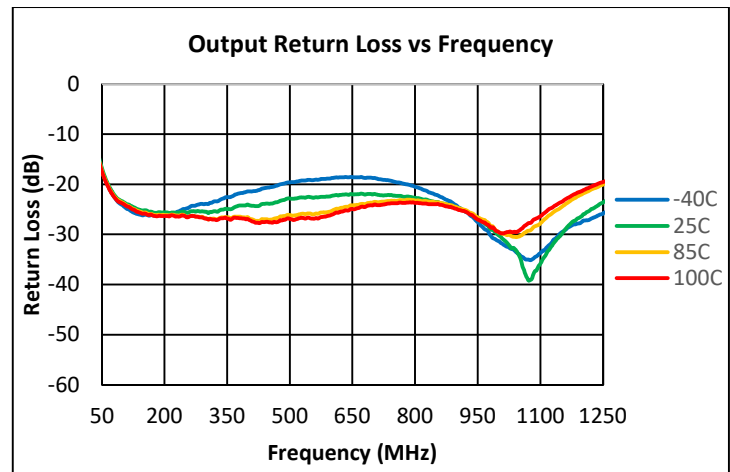
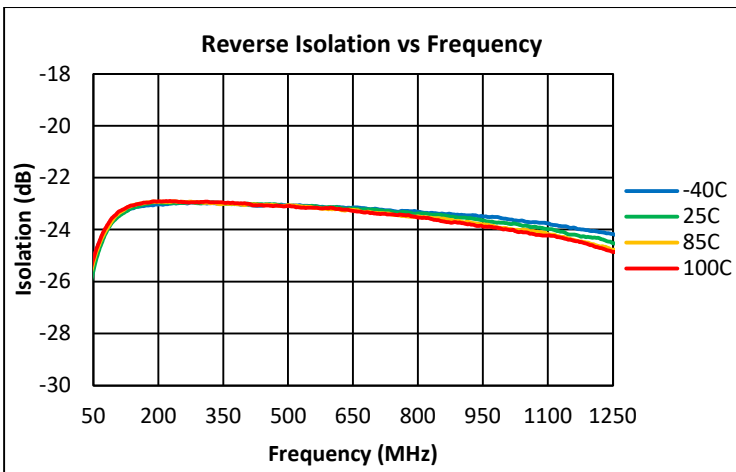
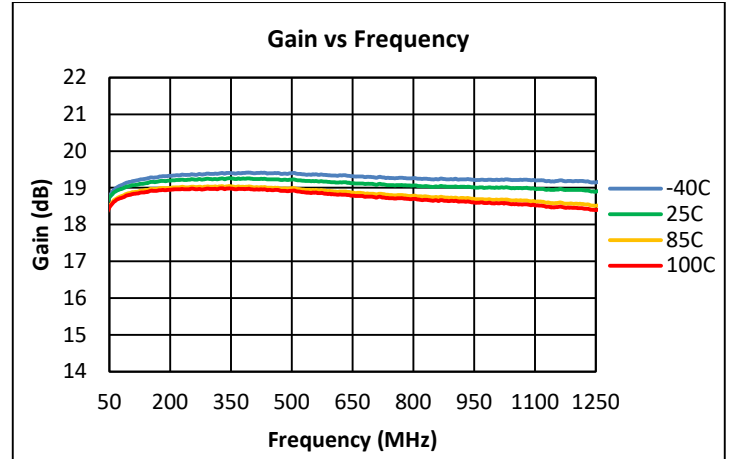
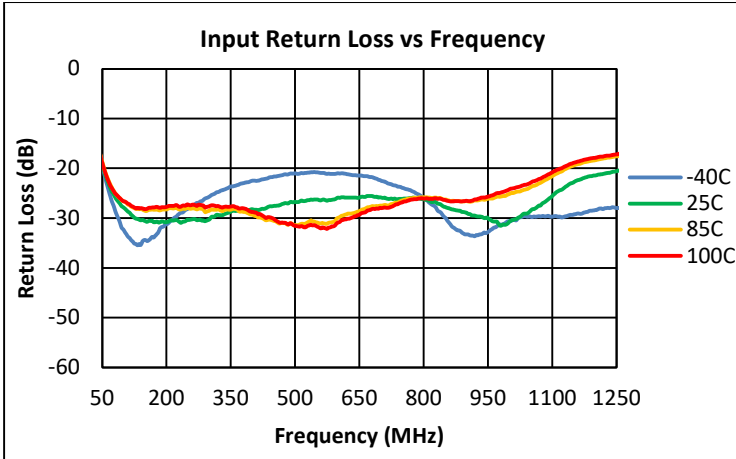

- Note:
- OIP3: +12 dBm / tone output, Δf = 6 MHz, 50-1218 MHz.

Performance Data for Downstream (5V, 50 – 1218 MHz)

Test conditions unless otherwise noted: V_{dd} = +5V, Temp = +25C, Z_o = 75Ω

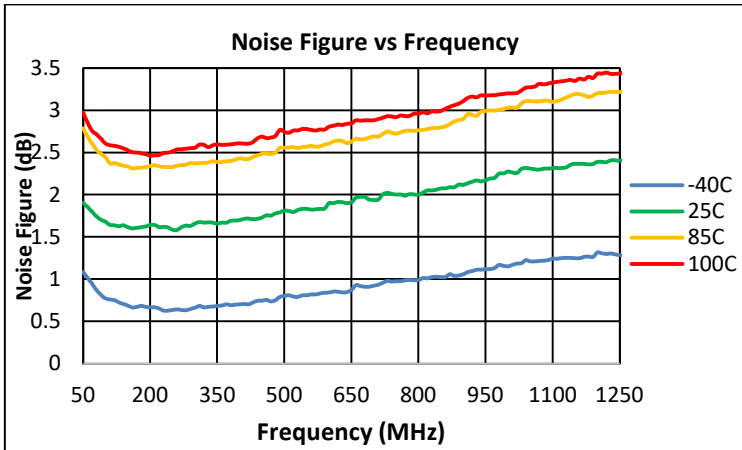
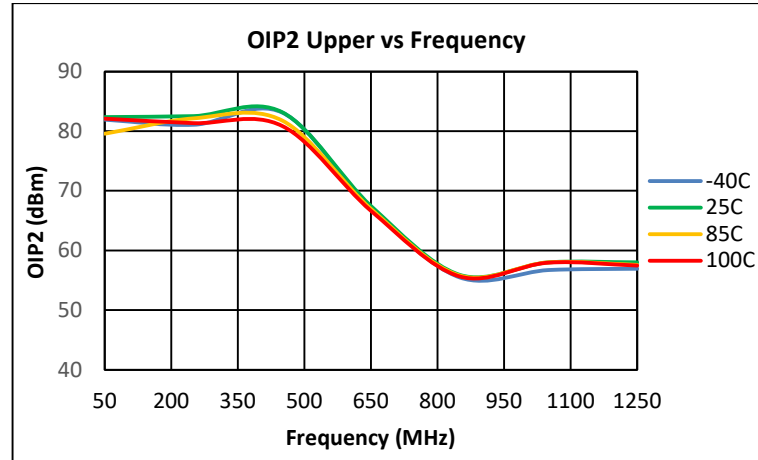
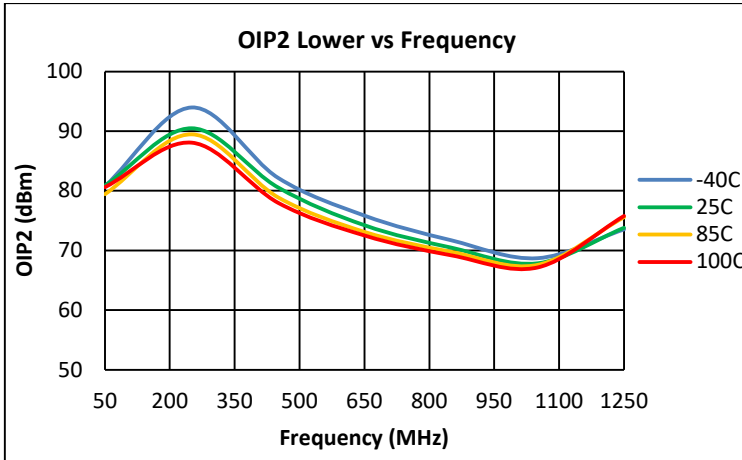

Notes:

- OIP2: +12 dBm / tone output, Δf = 53 MHz, 50-1218 MHz

Performance Data for Downstream (5V, 50 – 1218 MHz)

Test conditions unless otherwise noted: V_{dd} = +5V, Temp = +25C, Z_o = 75Ω

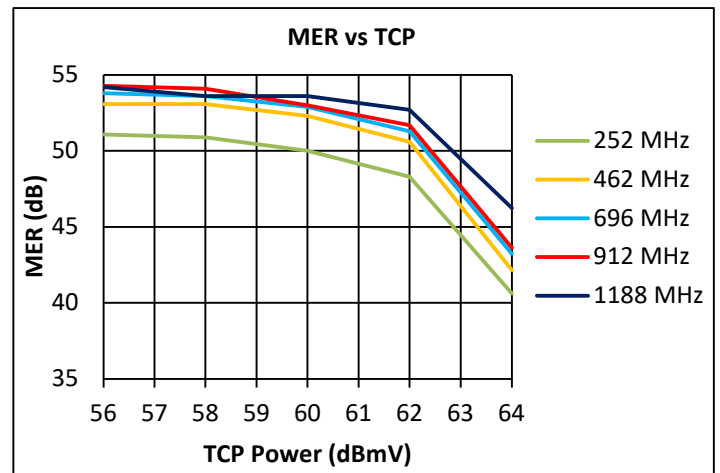
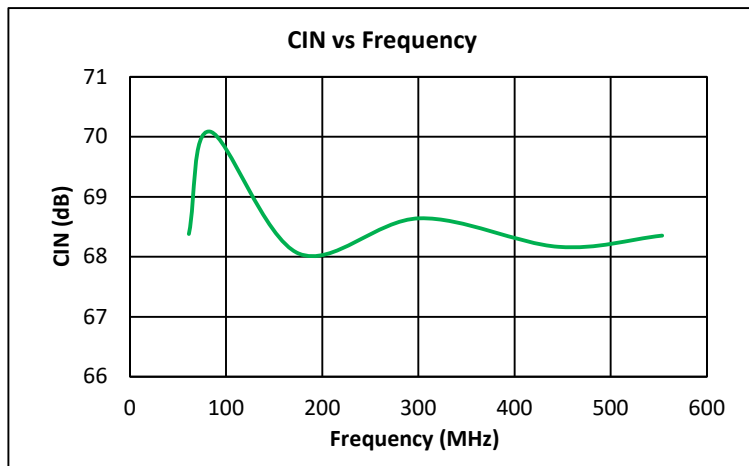
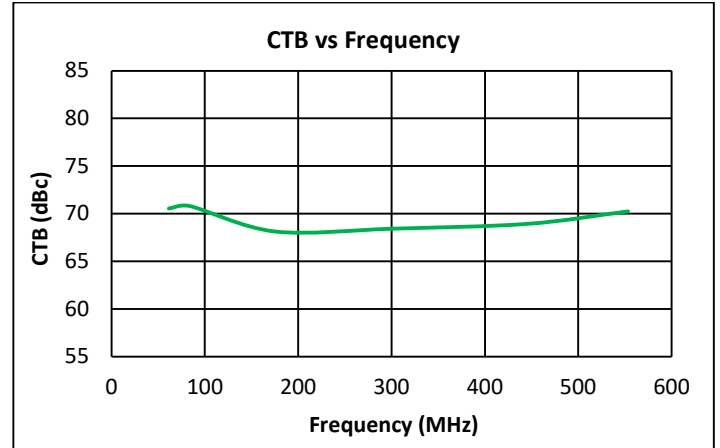
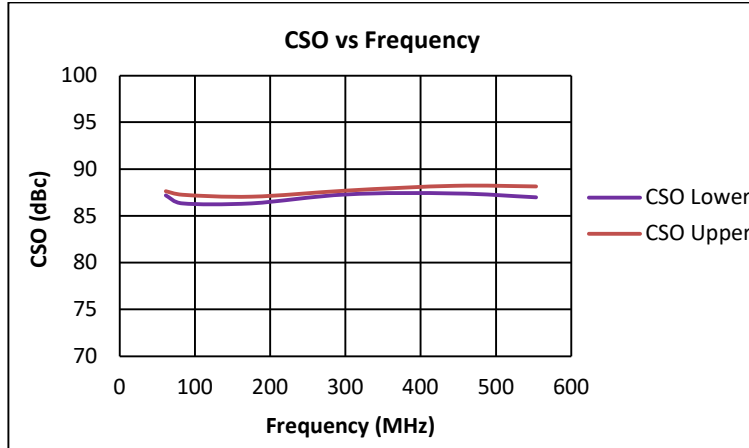

Notes:

1. CTB, CSO, and CIN: 79 channels + QAM to 1 GHz, 0 dB tilt, +39 dBmV per channel output
2. MER is source corrected; 10dB Tilt

Performance Data for Downstream (8V, 50 – 1218 MHz)

Test conditions unless otherwise noted: V_{dd} = +8V, Temp = +25C, Z_o = 75Ω

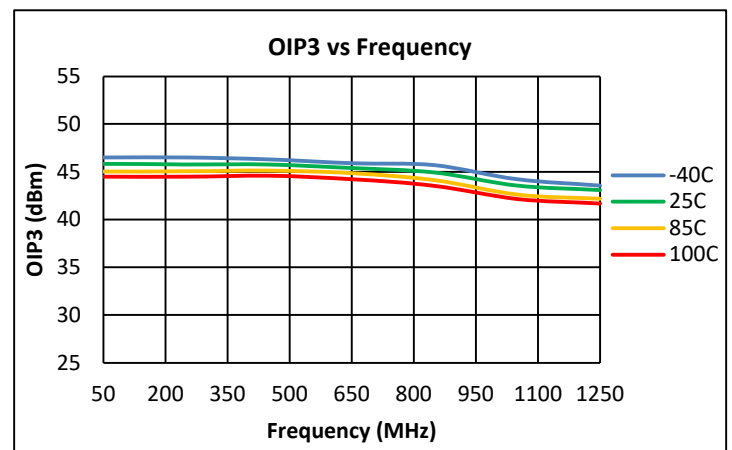
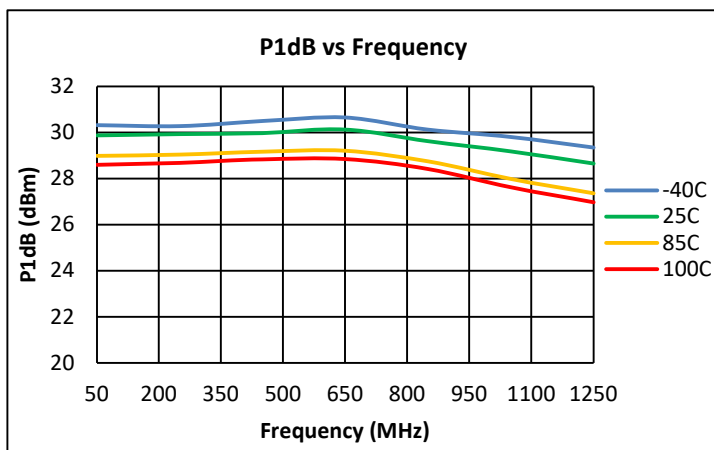
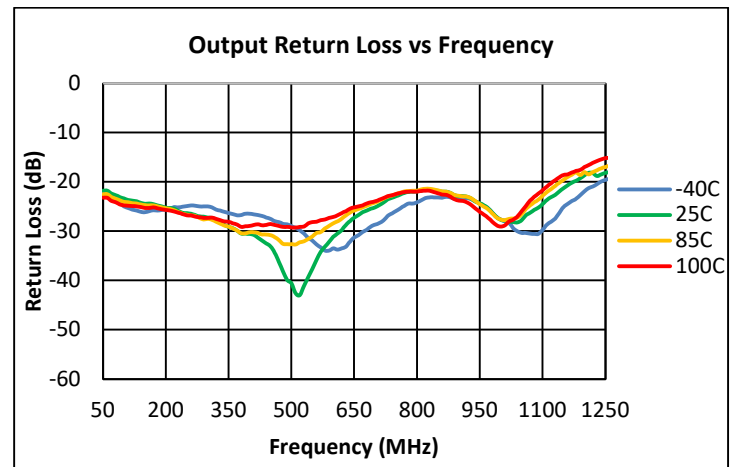
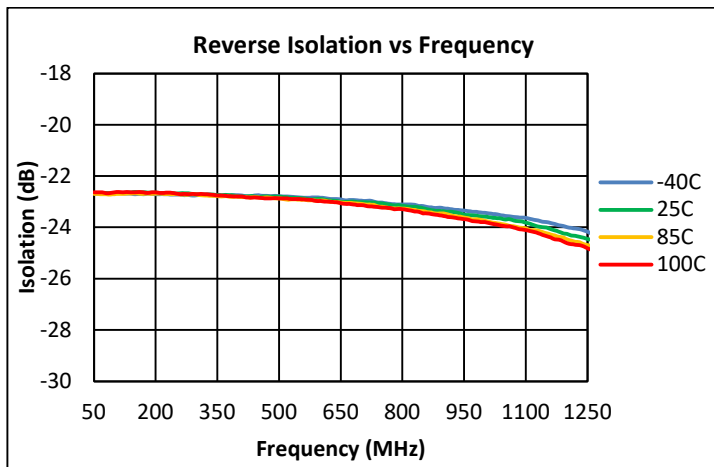
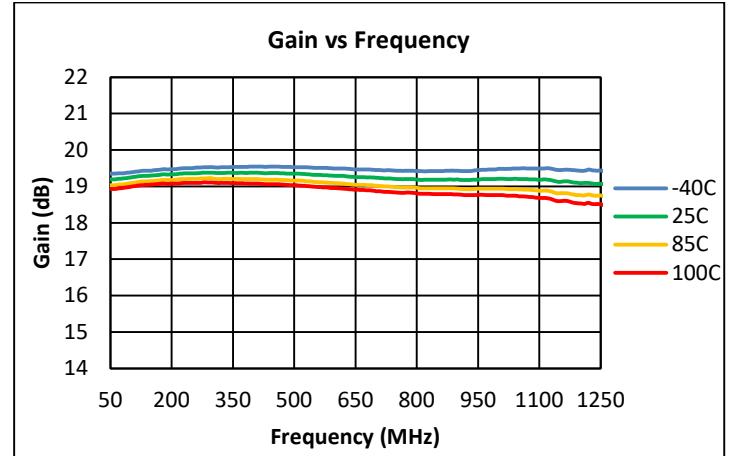
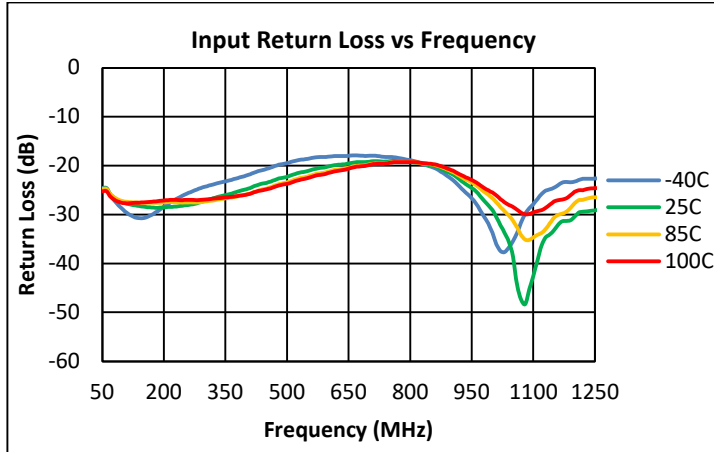

Note:

- OIP3: +12 dBm / tone output, Δf = 6 MHz, 50-1218 MHz.

Performance Data for Downstream (8V, 50 – 1218 MHz)

Test conditions unless otherwise noted: V_{dd} = +8V, Temp = +25C, Z_o = 75Ω

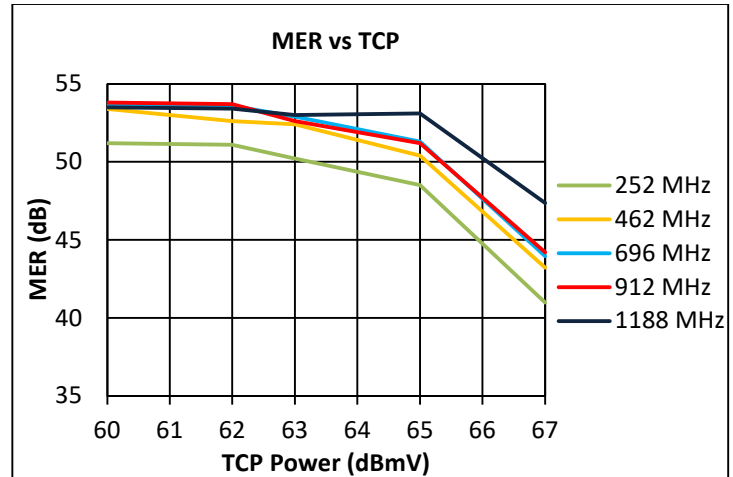
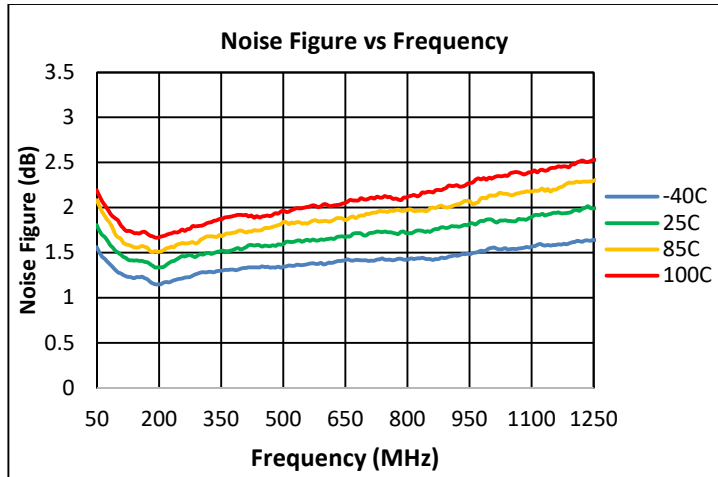
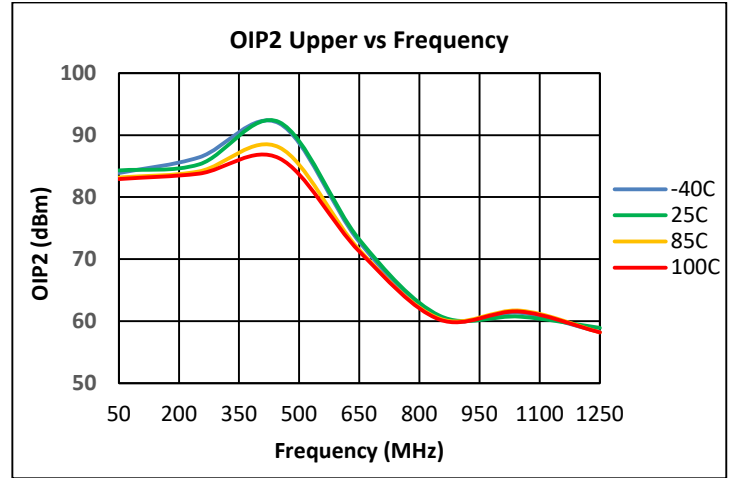
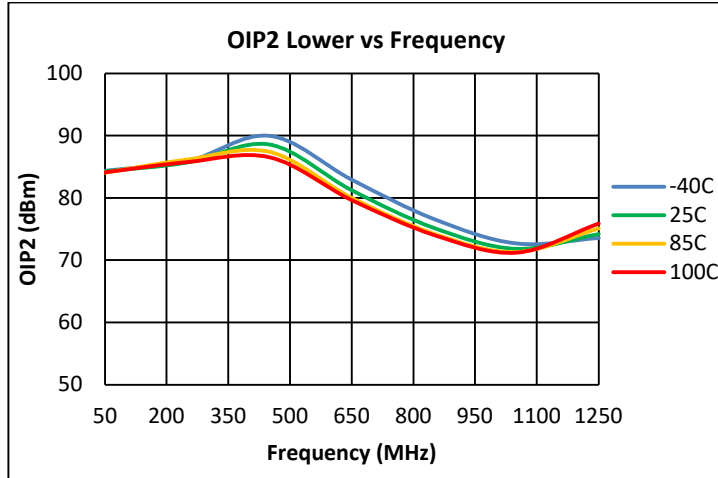

Note:

1. OIP2: +12 dBm / tone output, Δf = 53 MHz, 50-1218 MHz
2. MER is source corrected; 10dB Tilt

Evaluation Board Schematic for Upstream (5V, 5 – 300 MHz)

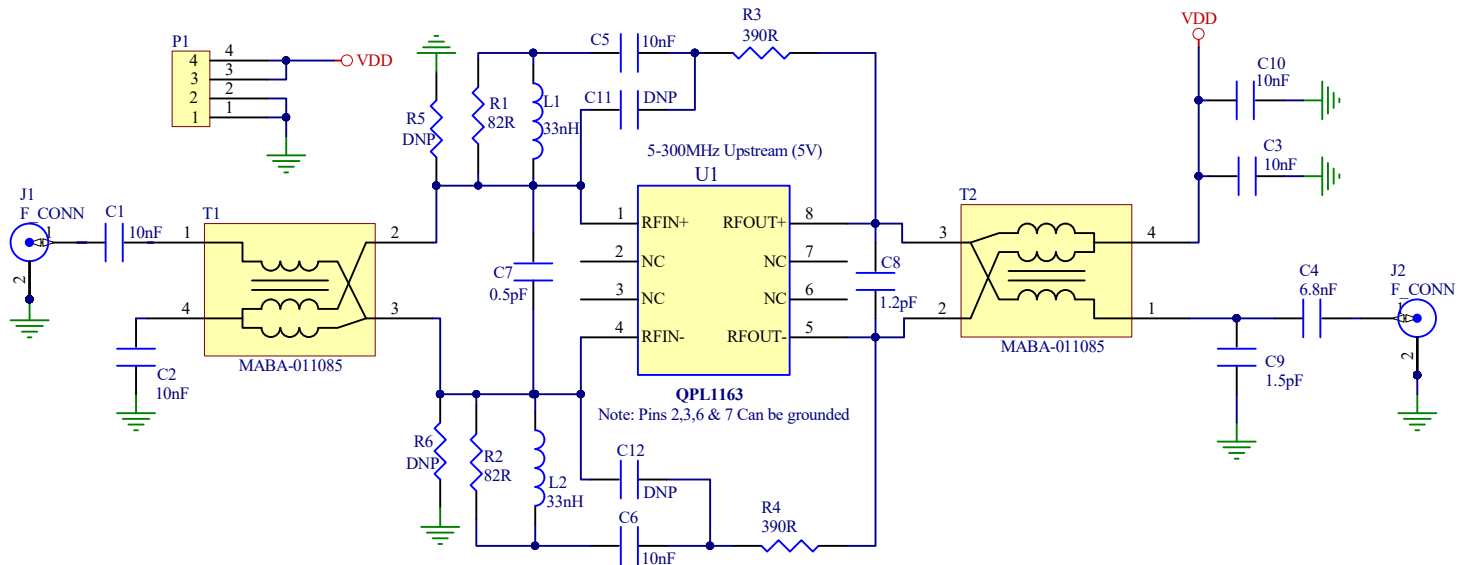

Bill of Material for Upstream (5V, 5 – 300 MHz)

Reference Designator	Description	Manufacturer	Part Number
U1	1218 MHz, 19 dB Push-Pull Amp	Qorvo	QPL1163SB
PCB	EVB PCB, QPL1163/1240	Qorvo	SAP # 302353
C1, C2, C3, C5, C6, C10	CAP, 0.01 uF, 5 %, 50 V, 0402	Murata	GRM1555C1H103JA01D
C4	CAP, 6800pF, +/-2%, 50V, HI-Q, 0402	Murata	GRM1555C1H682GE01D
C7	CAP, 0.5pF, +/-0.25pF, 50V, HI-Q, 0402	Murata	GJM1555C1HR50CB01D
C8	CAP, 1.2pF, +/-0.25pF, 50V, HI-Q, 0402	Murata	GJM1555C1H1R2CB01D
C9	CAP, 1.5pF, +/-0.25pF, 50V, HI-Q, 0402	Murata	GJM1555C1H1R5CB01D
L1, L2	IND, 33nH, 5%, M/L, 0402	Murata	LQG15HN33NJ02D
R1, R2	RES, 82 OHM, 5%, 1/16W, 0402	Kamaya	RMC1/16S-820JTH
R3, R4	RES, 390 OHM, 5%, 1/16W, 0402	Kamaya	RMC1/16S-391JTH
T1, T2	BALUN, 1:1	MACOM	MABA-011085*
P1	CONN, HDR	Samtec	TSW-103-07-G-S
J1, J2	CONN, F FEM, 75OHM	Millimeter Wave	MW-846-C-DD-75
Heatsink	HEATSINK, 50 x 50 x10, ALUMINUM	Alpha Nova Tech	S08EFV05-A
C11, C12, R5, R6	DNP		

* Alternate Balun: MRFXF5R09

* For 8V operation, populate R5 & R6 with 14K Ohm Resistors

Performance Data for Upstream (5V, 5 – 300 MHz)

Test conditions unless otherwise noted: V_{dd} = +5V, Temp = +25C, Z_o = 75Ω

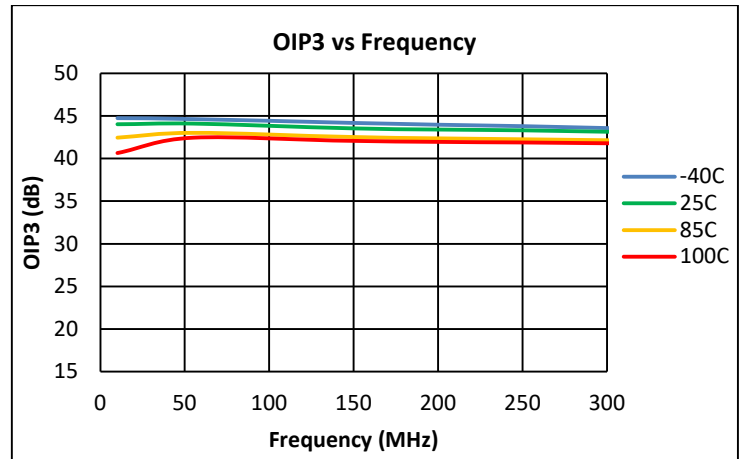
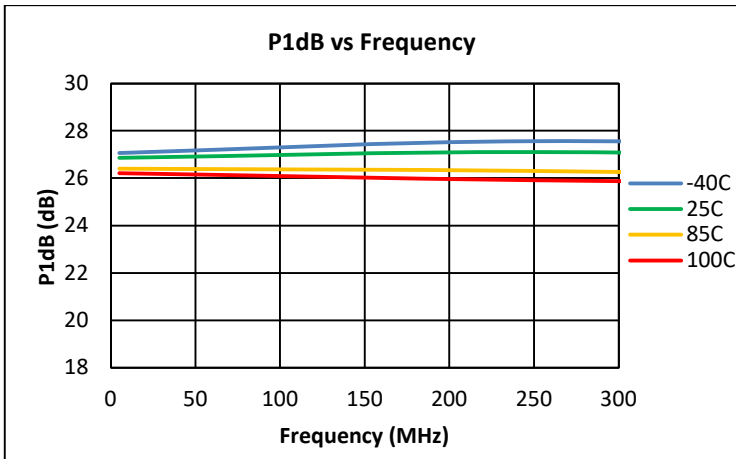
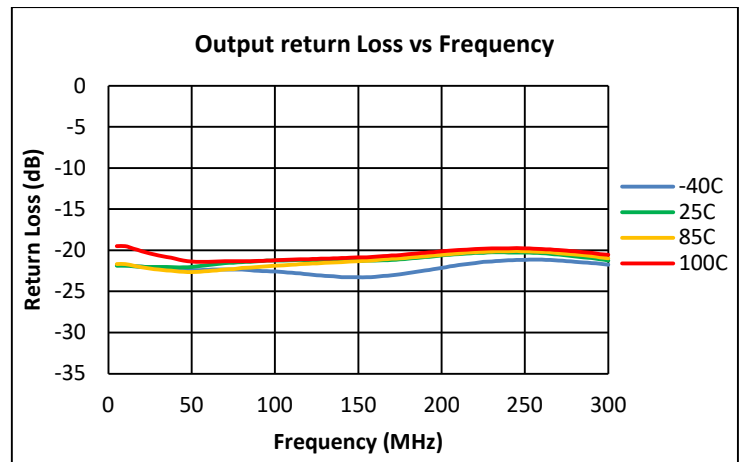
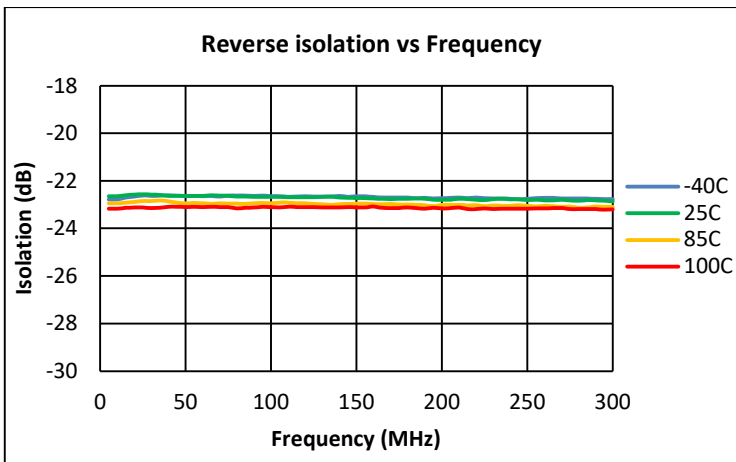
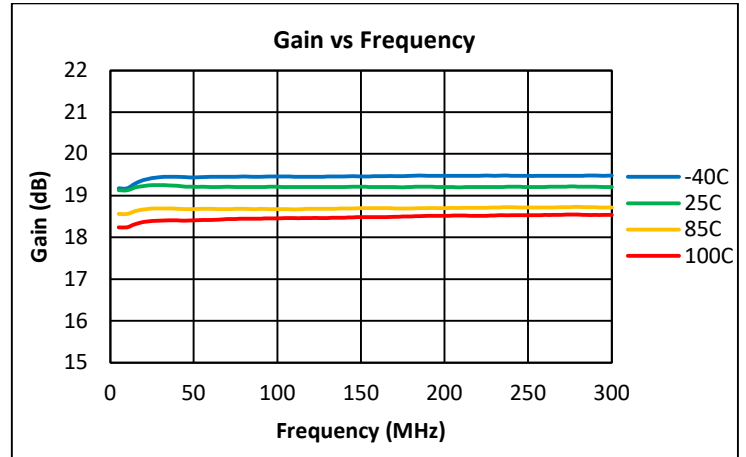
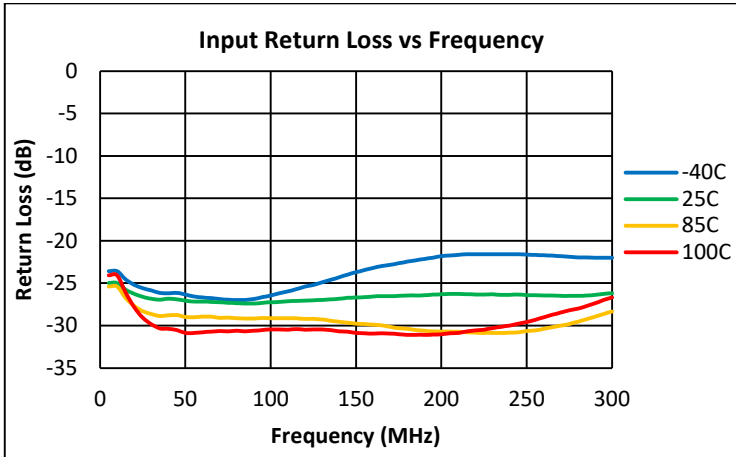

Notes:

- OIP3: +12 dBm / tone output, Δf = 6 MHz, 5-300 MHz.

Performance Data for Upstream (5V, 5 – 300 MHz)

Test conditions unless otherwise noted: V_{dd} = +5V, Temp = +25C, Z_o = 75Ω

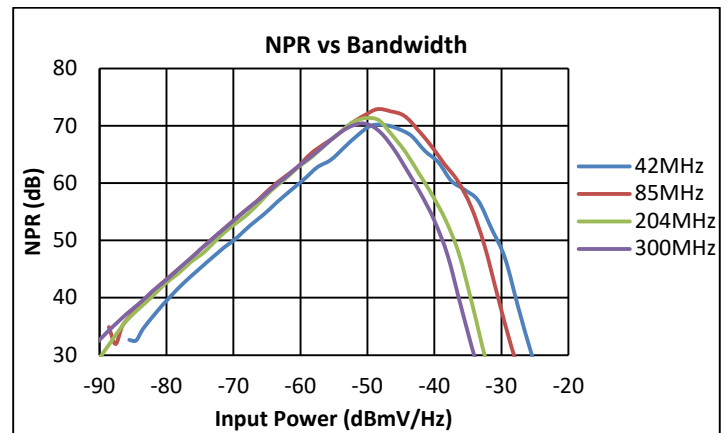
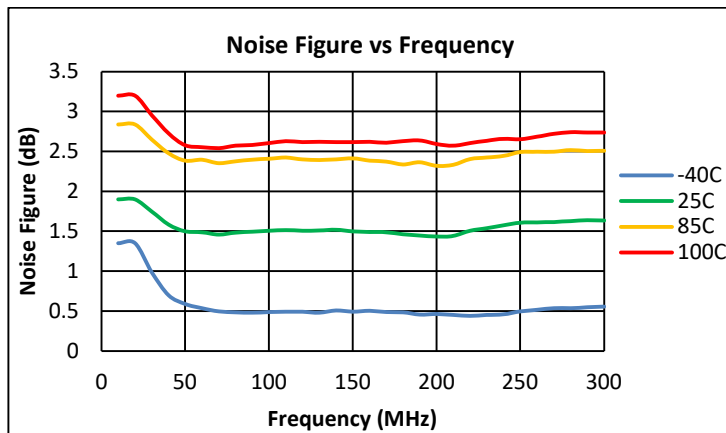
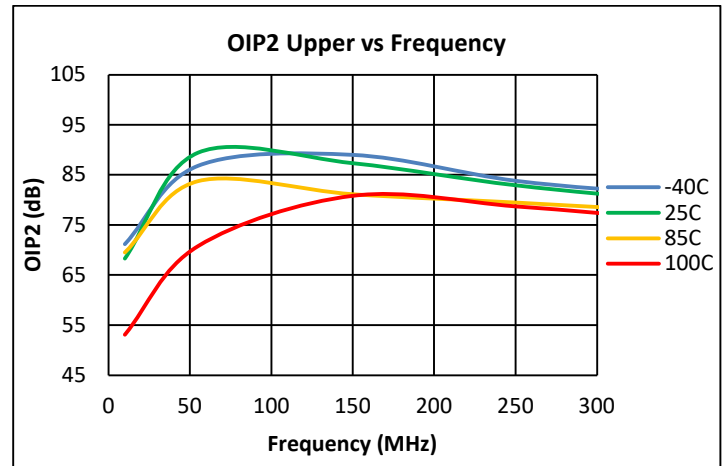
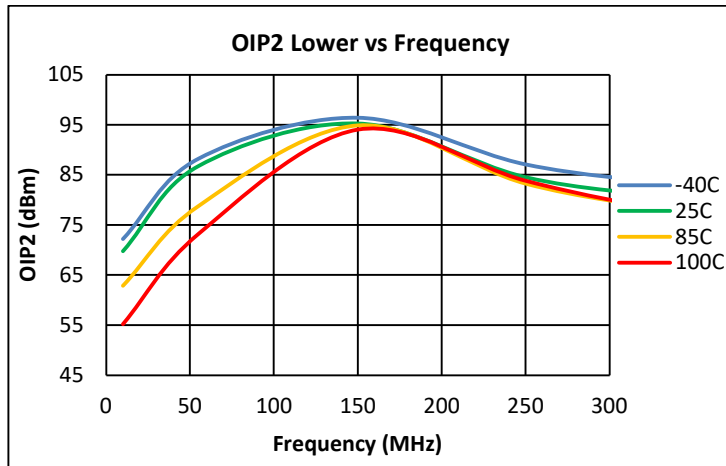

Notes:

- OIP2: +12 dBm / tone output, Δf = 53 MHz, 5-300 MHz.



Electrical Specifications for Upstream (5 – 700 MHz)

Parameter	Condition ⁽¹⁾	Min	Typ	Max	Unit
Supply Voltage (V_{DD})			5 / 8		V
Supply Current (I_{DD})	V_{DD} total current		275 / 330		mA
Frequency Range		5		700	MHz
Gain	5 - 700 MHz		19		dB
Gain Flatness	5 - 700 MHz		± 0.5		dB
Input Return Loss	5 - 700 MHz		20		dB
Output Return Loss	5 - 700 MHz		20		dB
Noise Figure	5 - 700 MHz		1.8		dB
OIP2	12 dBm / tone, $\Delta f = 53$ MHz, 5 - 700 MHz		80		dBm
OIP3	12 dBm / tone, $\Delta f = 6$ MHz, 5 - 700 MHz		45		dBm
Output P1dB	5 - 700 MHz		27		dBm
Thermal Resistance			20		$^{\circ}\text{C/W}$

Notes:

1. Typical performance at these conditions: Temp = +25 $^{\circ}\text{C}$, $V_{DD} = +5\text{V}$, 75 Ω system, Full band unless otherwise noted.

Evaluation Board Schematic for Upstream (5V, 5 – 700 MHz)

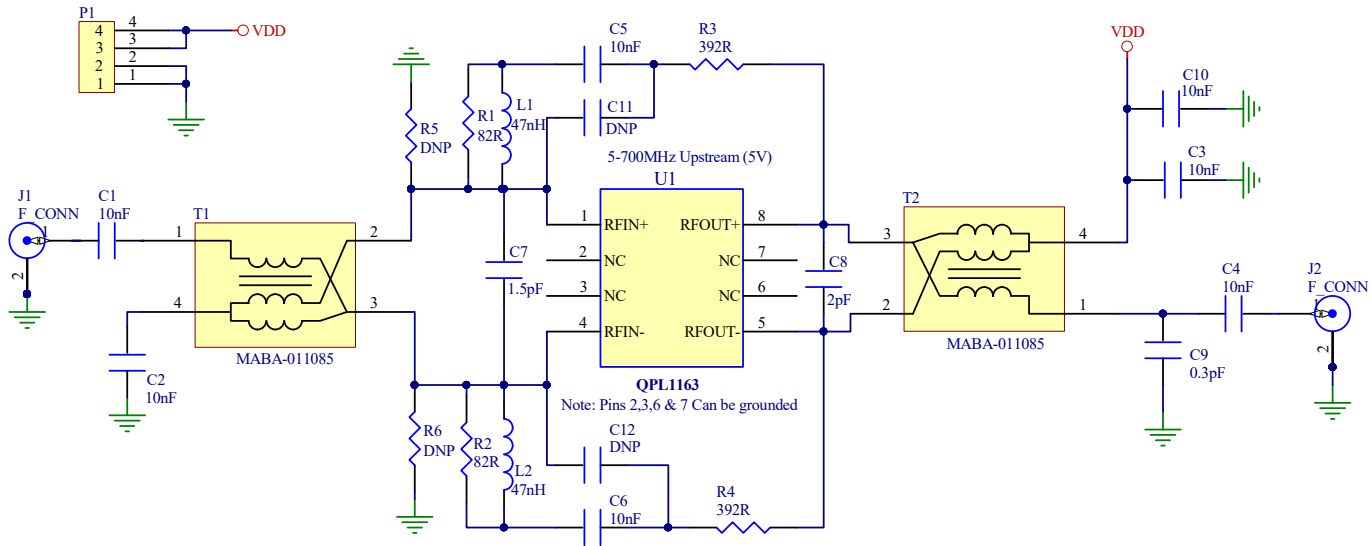

Bill of Material for Upstream (5V, 5 – 700 MHz)

Reference Designator	Description	Manufacturer	Part Number
U1	1218 MHz, 19 dB Push-Pull Amp	Qorvo	QPL1163SB
PCB	EVB PCB, QPL1163/1240	Qorvo	SAP # 302353
C1, C2, C3, C4, C5, C6, C10	CAP, 0.01 uF, 5 %, 50 V, 0402	Murata	GRM1555C1H103JA01D
C7	CAP, 1.5pF, +/-0.25pF, 50V, HI-Q, 0402	Murata	GJM1555C1H1R5CB01D
C8	CAP, 2pF, +/-0.25pF, 50V, HI-Q, 0402	Murata	GJM1555C1H2R0CB01D
C9	CAP, 0.3pF, +/-0.25pF, 50V, HI-Q, 0402	Murata	GJM1555C1HR30CB01D
L1, L2	IND, 47nH, 5%, M/L, 0402	Murata	LQG15HN47NJ02D
R1, R2	RES, 82 OHM, 5%, 1/16W, 0402	Kamaya	RMC1/16S-820JTH
R3, R4	RES, 392 OHM, 5%, 1/10W, 0402	Kamaya	RMC1/16SK3920FTH
T1, T2	BALUN, 1:1	MACOM	MABA-011085
P1	CONN, HDR	Samtec	TSW-103-07-G-S
J1, J2	CONN, F FEM, 75OHM	Millimeter Wave	MW-846-C-DD-75
Heatsink	HEATSINK, 50 x 50 x10, ALUMINUM	Alpha Nova Tech	S08EFV05-A
C11, C12, R5, R6	DNP		

*For 8V operation, populate R5 & R6 with 14K Ohm Resistors

Performance Data for Upstream (5V, 5 – 700 MHz)

Test conditions unless otherwise noted: V_{dd} = +5V, Temp = +25C, Z_o = 75Ω

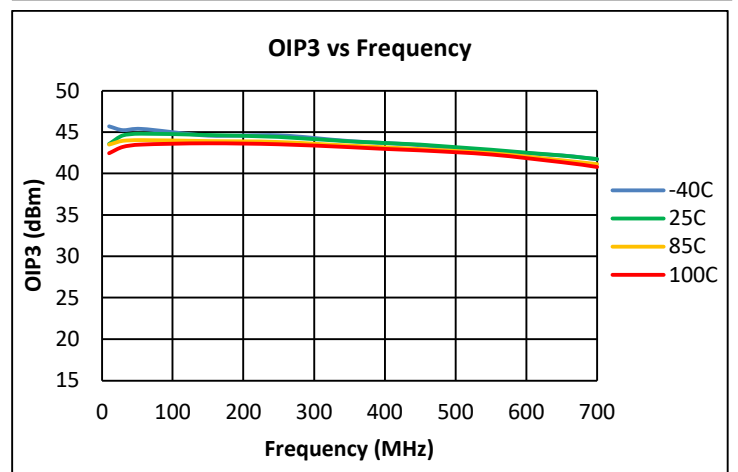
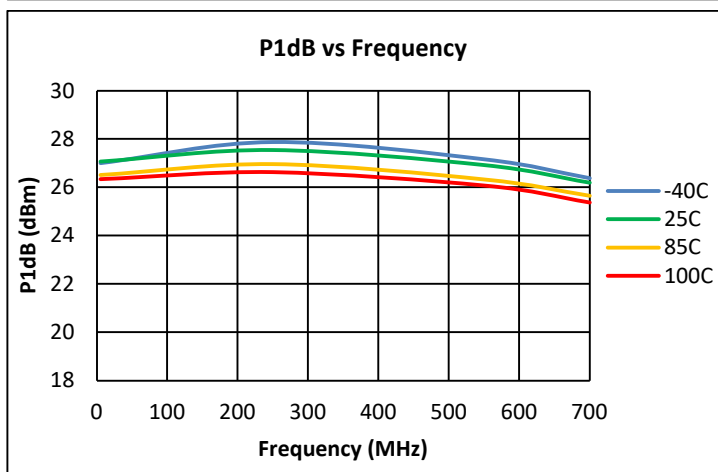
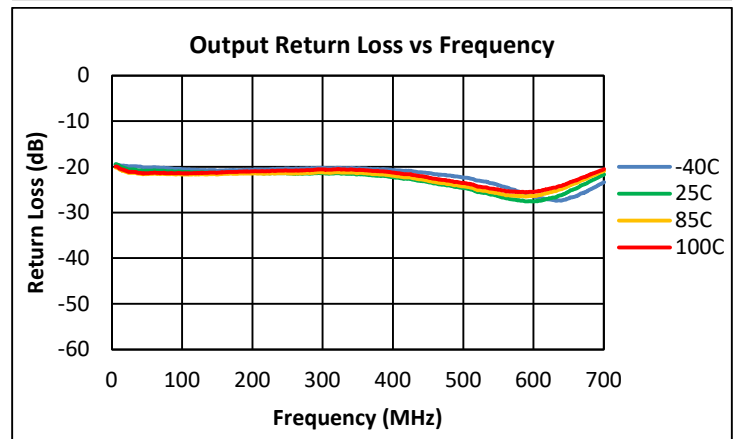
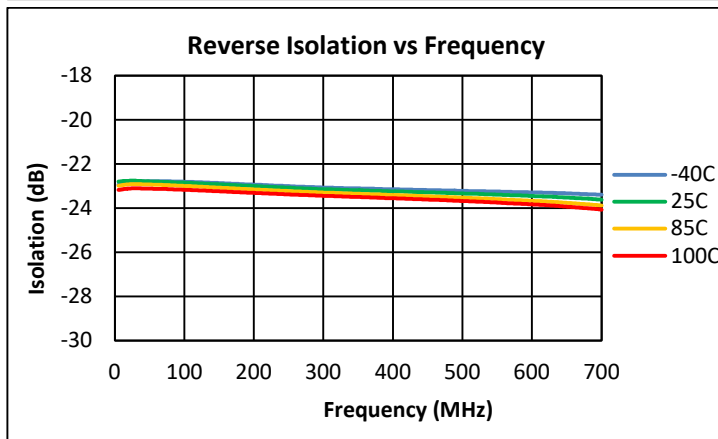
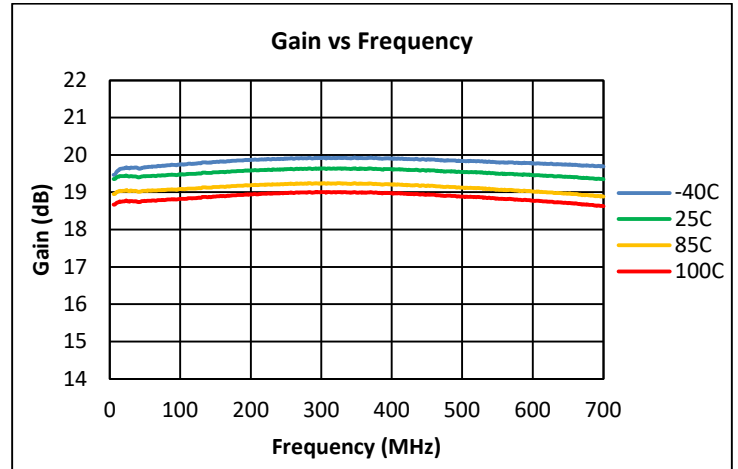
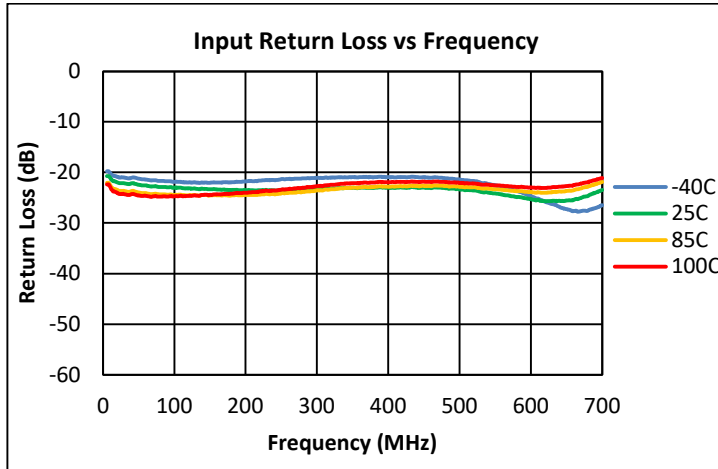

Notes:

- OIP3: +12 dBm / tone output, Δf = 6 MHz, 5-700 MHz.

Performance Data for Upstream (5V, 5 – 700 MHz)

Test conditions unless otherwise noted: V_{dd} = +5V, Temp = +25C, Z_o = 75Ω

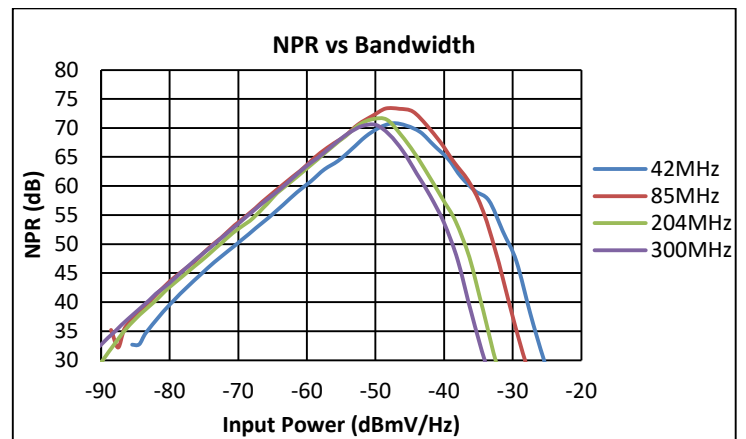
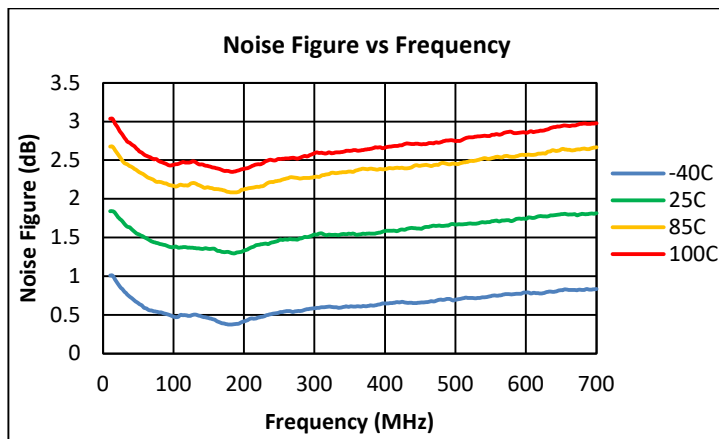
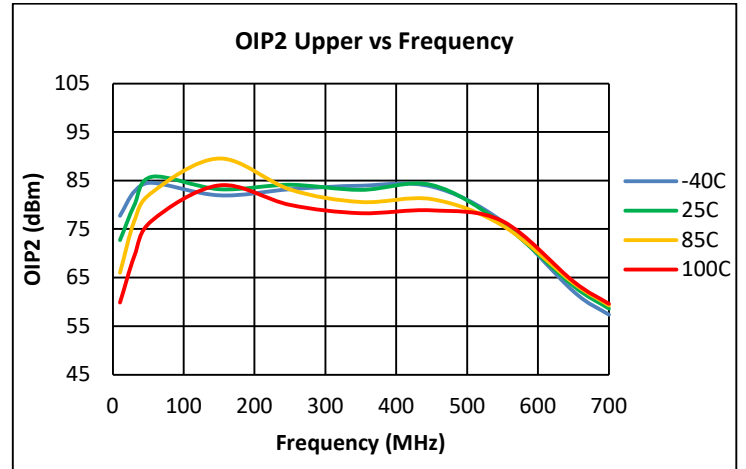
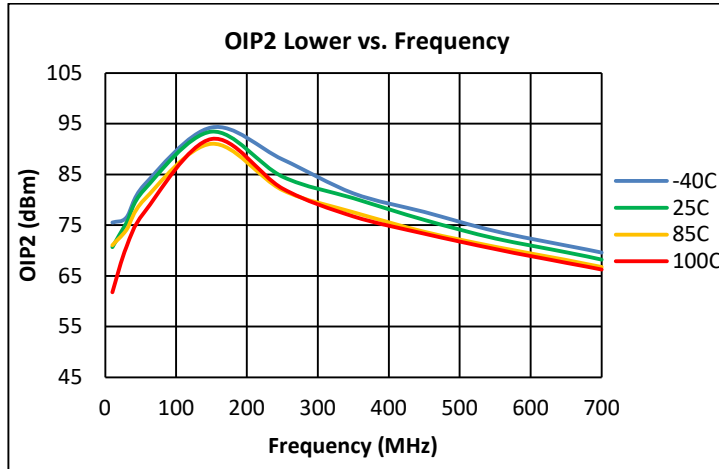

Notes:

1. OIP2: +12 dBm / tone output, Δf = 53 MHz, 5-700 MHz

Performance Data for Upstream (8V, 5 – 700 MHz)

Test conditions unless otherwise noted: V_{dd} = +8V, Temp = +25C, Z_o = 75Ω

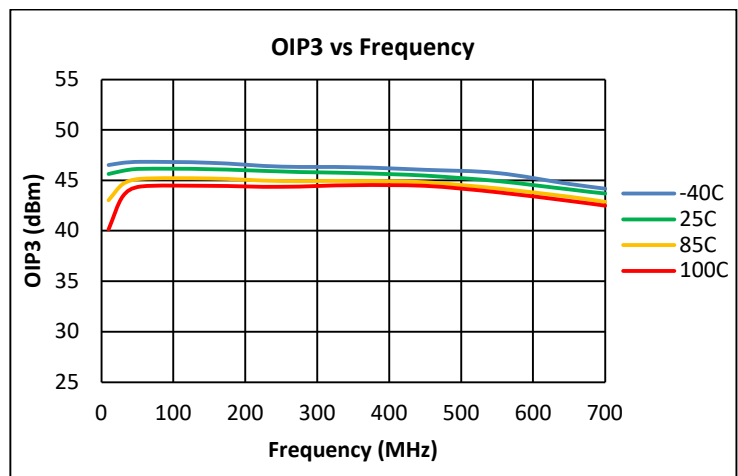
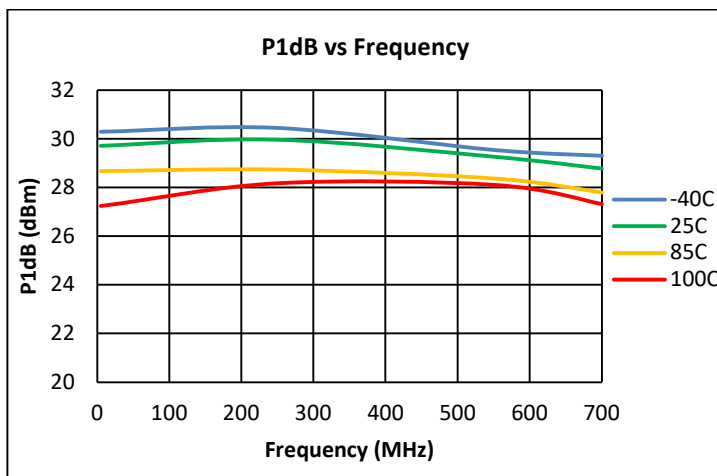
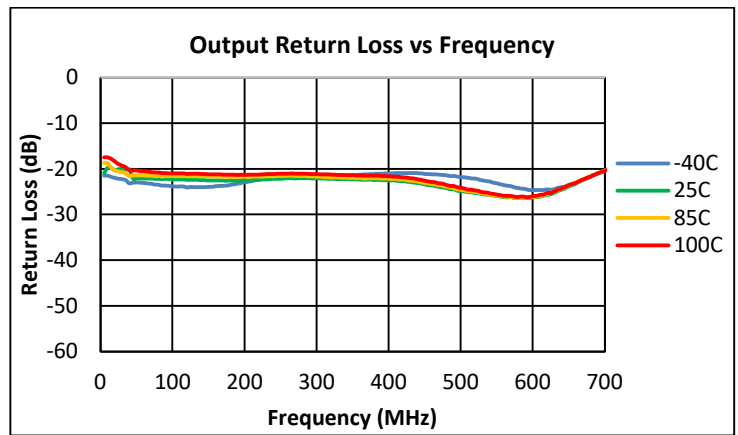
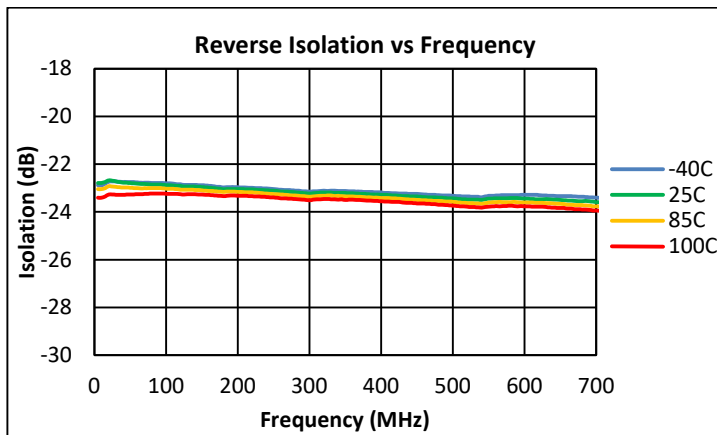
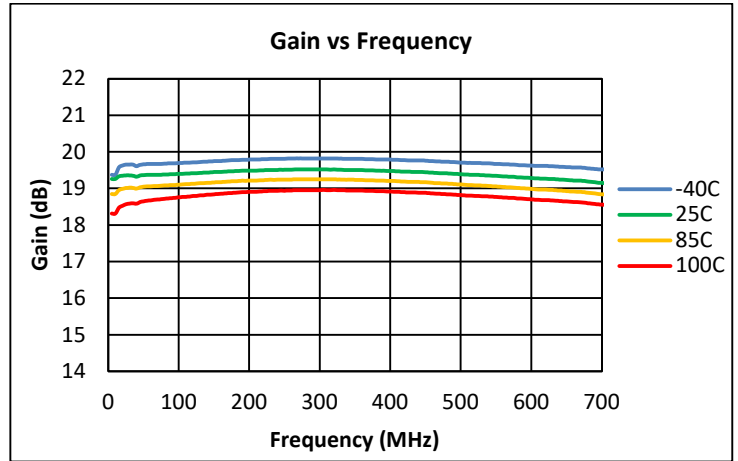
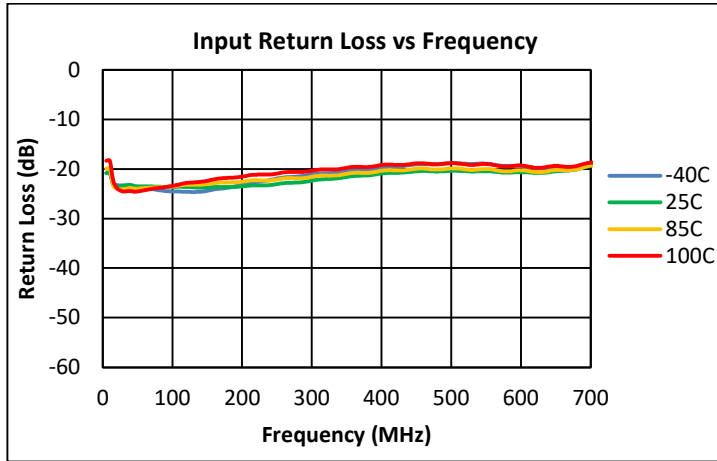

Notes:

- OIP3: +12 dBm / tone output, Δf = 6 MHz, 5-700 MHz.

Performance Data for Upstream (8V, 5 – 700 MHz)

Test conditions unless otherwise noted: V_{dd} = +8V, Temp = +25C, Z_o = 75Ω

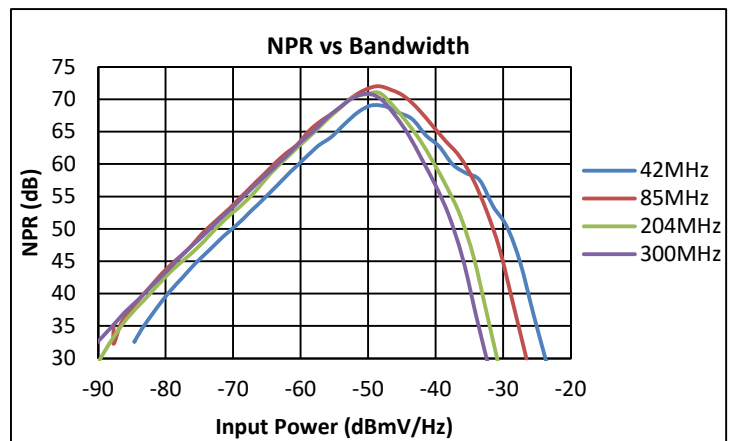
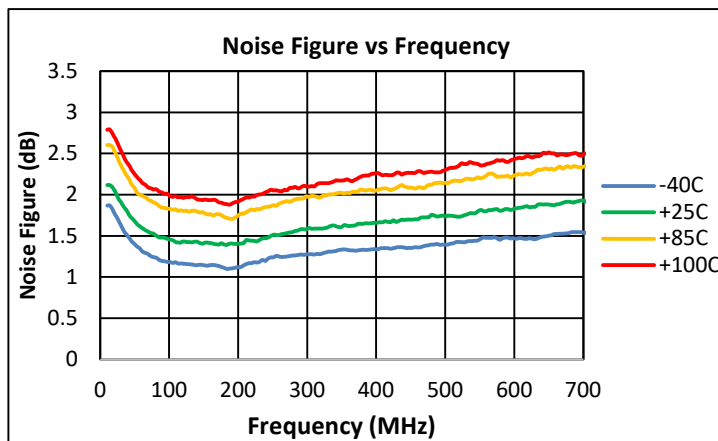
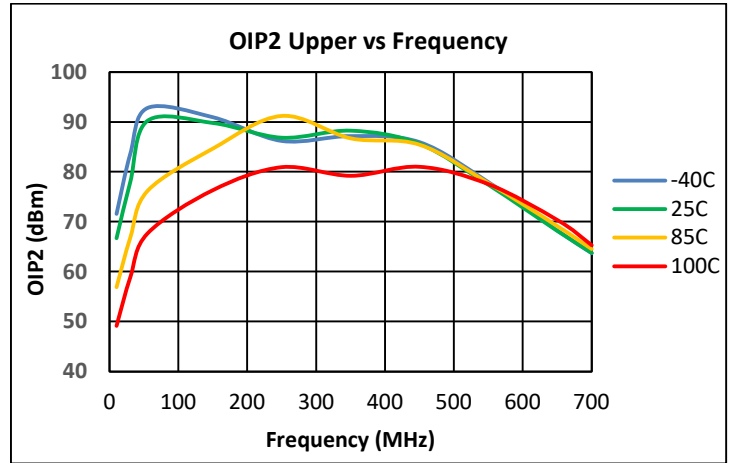
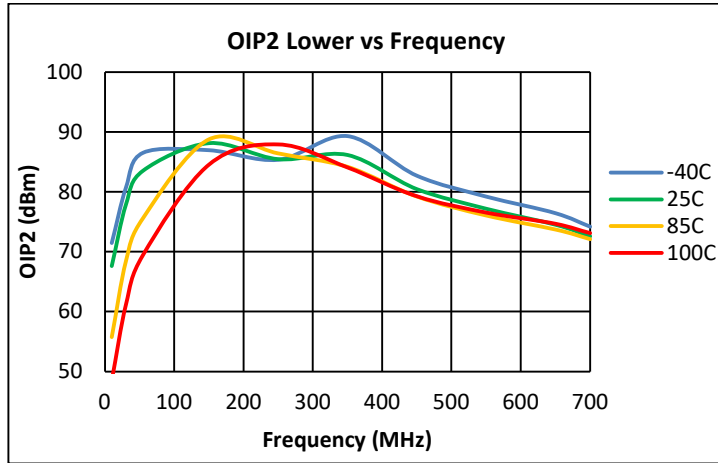

Notes:
 OIP2: +12 dBm / tone output, Δf = 53 MHz, 5-700 MHz

Pin Configuration and Description

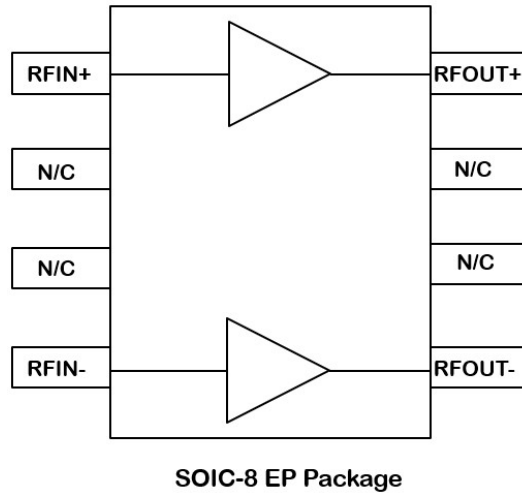

Pin	Name	Description
1	RFIN+	RF input for plus side of amplifier
2	N/C	No Internal Connection (Pin can be grounded)
3	N/C	No Internal Connection (Pin can be grounded)
4	RFIN-	RF input for minus side of amplifier
5	RFOUT-	RF output for minus side of amplifier, Vdd (requires bias choke)
6	N/C	No Internal Connection (Pin can be grounded)
7	N/C	No Internal Connection (Pin can be grounded)
8	RFOUT+	RF output for plus side of amplifier, Vdd (requires bias choke)
Slug	GND	RF, DC, and Thermal Ground

Package Marking

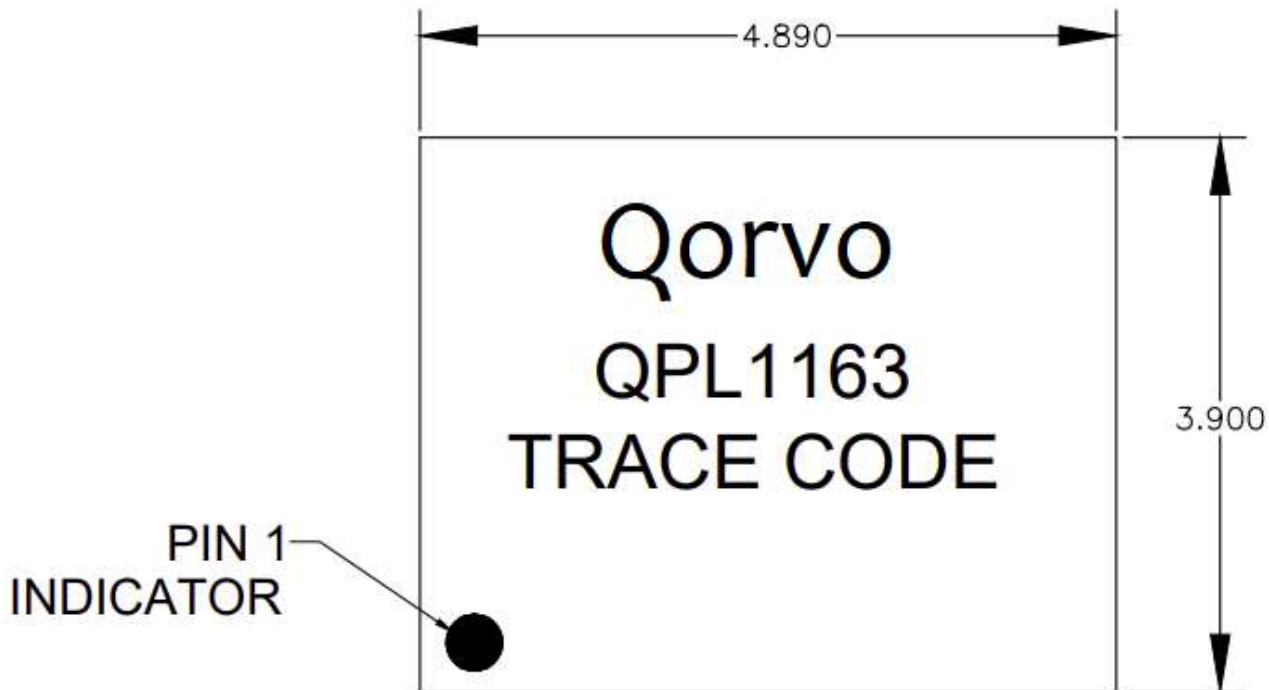

NOTES:

LINE 1: QPL1163

LINE 2: TRACE CODE.

TRACE CODE TO BE
ASSIGNED BY SUBCON.

Package Outline

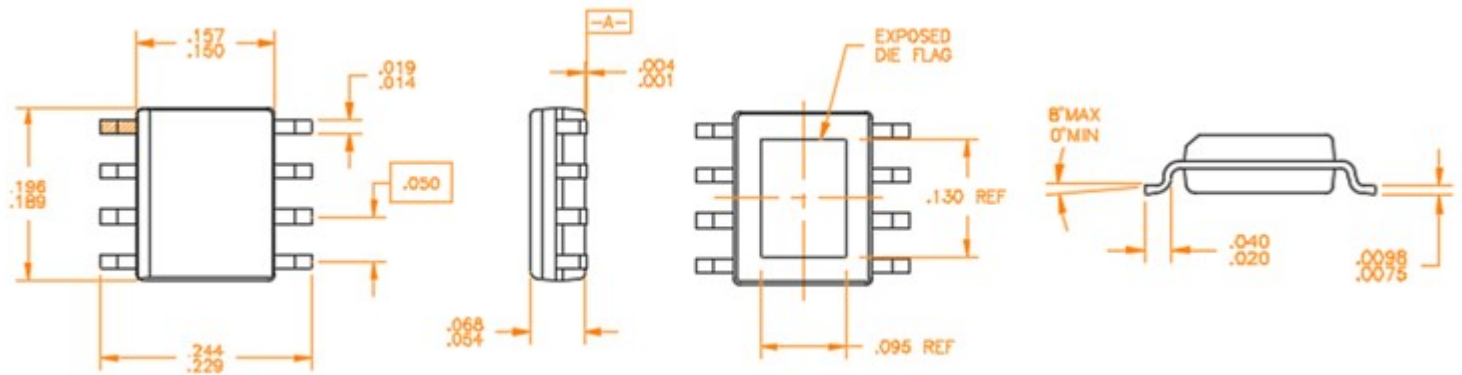

Notes:

1. All Dimensions are in inches.
2. Angles are in degrees.

Recommended PCB Land Pattern

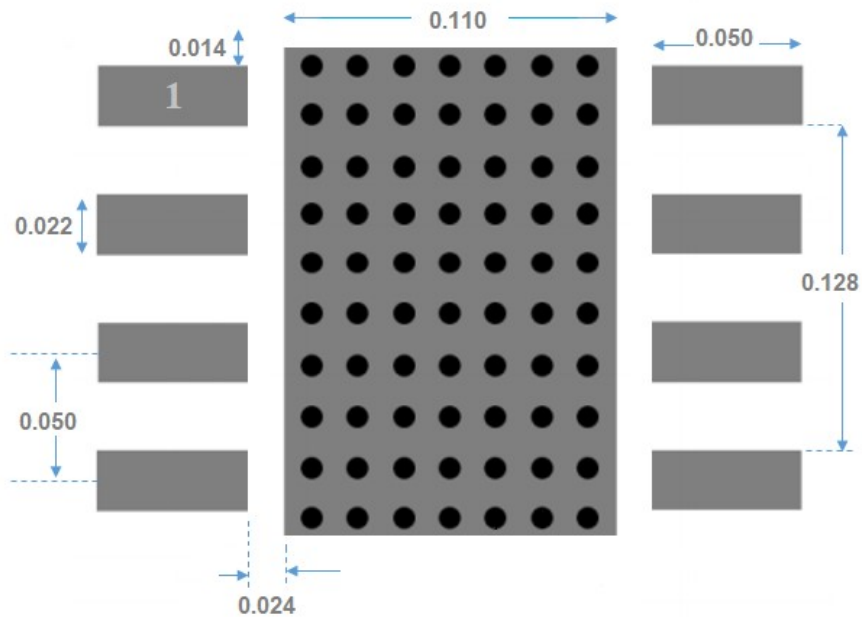

Notes: All dimensions are in millimeters. Angles are in degrees.

1. Use 1 oz. copper minimum for top and bottom layer metal.
2. Vias are required under the backside paddle for proper RF/DC grounding and thermal dissipation.
3. Recommend about 70 vias of 8mil diameter as shown in the land pattern.