

### Product Overview

The QPL1240 is an ultra-linear GaAs pHEMT 75-Ohm differential amplifier IC with 5–1218 MHz operating bandwidth. This amplifier provides 17.9 dB of gain and very low noise figure. The Differential push-pull topology provides excellent 2<sup>nd</sup> order intermodulation performance. The QPL1240 can be used as a low noise balanced amp in DOCSIS downstream, as well as upstream applications, due to its wide operational bandwidth. The QPL1240 is packaged in a SOIC-8 plastic package.



8-Pin SOIC Package

### Functional Block Diagram

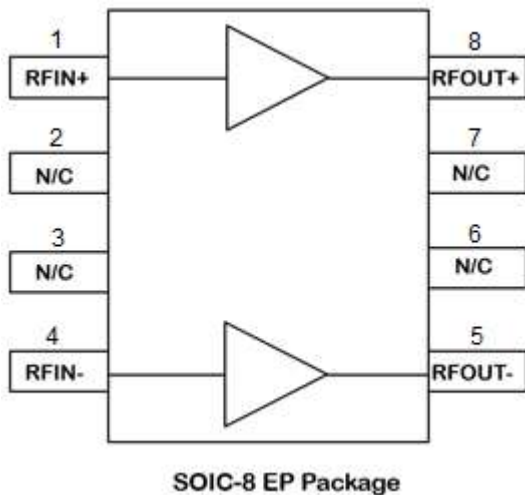

### Key Features

- High Gain: 17.9 dB at 1218 MHz
- 5 – 1218 MHz BW
- OIP3: +42.5 dBm, Downstream 50 – 1218 MHz
- OP1dB: 26.6 dBm, Downstream 50 – 1218 MHz
- Low Noise Figure: < 2.6 dB, Downstream
- Excellent Composite Distortion
- pHEMT GaAs device technologies
- Compact Size: 8-pin SOIC
- 5 to 8V supply voltage operation

### Ordering Information

Part Number	Description
QPL1240SB	Sample bag with 5 pieces
QPL1240SR	7" Reel with 100 pieces
QPL1240TR13	13" Reel with 2500 pieces
QPL1240EVB-01	5V, 50 – 1218 MHz Eval Board
QPL1240EVB-02	5V, 5 – 700 MHz Eval Board
QPL1240EVB-03	8V, 50 – 1218 MHz Eval Board
QPL1240EVB-04	8V, 5 – 700 MHz Eval Board

### Applications

- DOCSIS 3.1 Systems
- Balanced Antenna Applications
- HFC Optical Nodes
- 75 Ω Amplifiers
- Upstream Amplifier for DOCSIS 3.1 and DOCSIS 4.0 Applications

### Absolute Maximum Ratings

Parameter	Rating
Supply Voltage (V <sub>DD</sub> )	+10 V
Supply Current (I <sub>DD</sub> )	400 mA
Maximum Input Level	+15 dBm
Operating Case Temperature Range	-40 to +100 °C
Storage Temperature Range	-40 to +150 °C
Maximum Junction Temperature	+150 °C

Exceeding any one or a combination of the Absolute Maximum Rating conditions may cause permanent damage to the device. Extended application of Absolute Maximum Rating conditions to the device may reduce device reliability.

### Electrical Specifications for Downstream (50-1218MHz)

Parameter	Condition <sup>(1)</sup>	Min	Typ	Max	Unit
Supply Voltage (V <sub>DD</sub> )			5 / 8		V
Supply Current (I <sub>DD</sub> )	V <sub>DD</sub> total current		275/330		mA
Frequency Range		50		1218	MHz
Gain	50 – 1218 MHz		17.9		dB
Gain Flatness	50 – 1218 MHz		±0.5		dB
Input Return Loss	50 – 1218 MHz		20		dB
Output Return Loss	50 – 1218 MHz		20		dB
Noise Figure	50 MHz		1.7		dB
	1218 MHz		2.6		
CSO	79 Ch + QAM to 1 GHz, +39dBmV / Ch, 0dB tilt, Downstream		82		dBc
CTB			67		dBc
OIP2	13 dBm / tone, Δf = 53 MHz, 50-1218 MHz		68		dBm
OIP3	13 dBm / tone, Δf = 6 MHz, 50-1218 MHz		43		dBm
Output P1dB	50 – 1218 MHz		27		dBm
Thermal Resistance	Junction to case		20		°C/W

Notes:

1. Typical performance at these conditions: Temp = +25 °C, V<sub>DD</sub> = +5V, 75 Ω system, Full band unless otherwise noted.
2. Downstream (Forward Path) Freq Range is 50-1218 MHz

### Evaluation Board Schematic for Downstream (5V, 50 – 1218MHz)

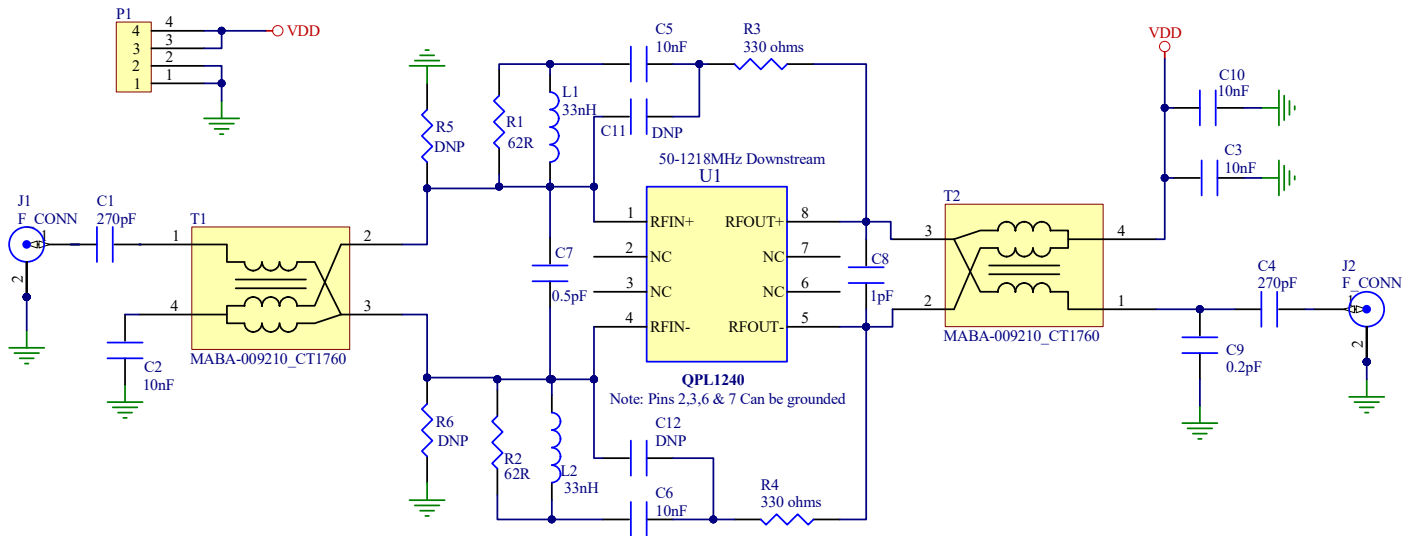

### Bill of Material for Downstream (5V, 50 – 1218MHz)

Reference Designator	Description	Manufacturer	Part Number
U1	1218 MHz, 19 dB Push-Pull Amp	Qorvo	QPL1240SB
PCB	EVB PCB, QPL1163/1240	Qorvo	SAP # 302353
C1, C4	CAP, 270 pF, 5 %, 0402	Murata	GCM1555C1H271JA16D
C2, C3, C5, C6, C10	CAP, 0.01 uF, 5 %, 50 V, 0402	Murata	GRM155R11H103JA88
C8	CAP, 1pF, +/-0.05pF, 50V, HI-Q, 0402	Murata	GJM1555C1H1R0WB01D
C9	CAP, 0.2pF, +/-0.1pF, 50V, HI-Q, 0402	Murata	GJM1555C1HR20BB01D
C7	CAP, 0.5pF, +/-0.25pF, 50V, HI-Q, 0402	Murata	GJM1555C1HR50CB01D
R1, R2	RES, 62 OHM, 5%, 1/16W, 0402	Kamaya	RMC1/16S-620JTH
L1, L2	IND, 33nH, 5%, M/L, 0402	Murata	LQG15HN33NJ02D
R3, R4	RES, 330 OHM, 5%, 1/16W, 0402	Kamaya	RMC1/16S-331JTH
T1, T2	BALUN, 1:1	MACOM	MABA-009210-CT1760
T1, T2 (Alternate vendor)	BALUN, 1:1	Mini-RF	MRFXF0072
P1	CONN, HDR	Samtec	TSW-103-07-G-S
J1, J2	CONN, F FEM, 75OHM	Millimeter Wave	MW-846-C-DD-75
Heatsink	HEATSINK, 50 x 50 x10, ALUMINUM	Alpha Nova Tech	S08EFV05-A
C11, C12, R5, R6	DNP		

- For 8V operation, populate R5 & R6 with 12K Ohm Resistors

### Evaluation Board Layout

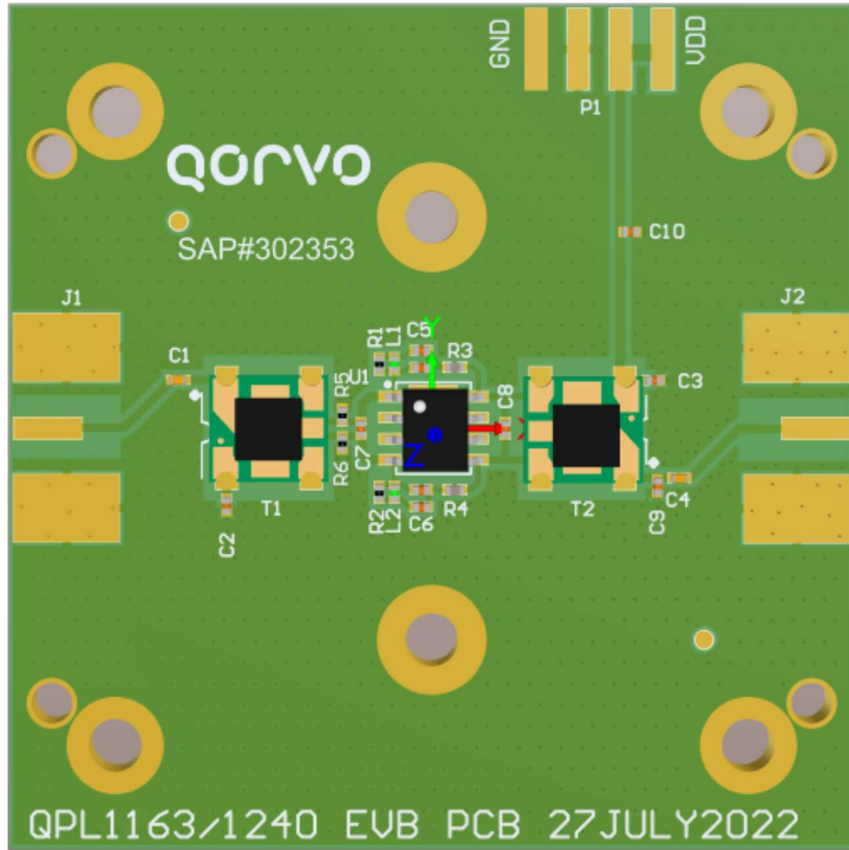

#### LAYER STACK LEGEND

Material	Layer	Thickness	Dielectric Material	Type	Comment
	Top Overlay			Legend	HIGH TEMPERATURE, NON-CONDUCTIVE, WHITE EPOXY BASED INK.
Surface Material	Top Solder	0.0004in	Solder Resist	Solder Mask	LPI (LIQUID PHOTO-IMAGEABLE), OR LDI (LASER DIRECT IMAGEABLE), GREEN. MAX FINISH THICKNESS TO BE 0.001in.
<b>Copper</b>	<b>Top Layer</b>	<b>0.0014in</b>		<b>Signal</b>	
		0.0580in	FR-4	Dielectric	
<b>Copper</b>	<b>Bottom Layer</b>	<b>0.0014in</b>		<b>Signal</b>	
Surface Material	Bottom Solder	0.0004in	Solder Resist	Solder Mask	
	Bottom Overlay			Legend	

### Performance Data for Downstream (5V, 50-1218 MHz)

Test conditions unless otherwise noted: Vdd = +5V, Temp = +25C, Zo = 75Ω

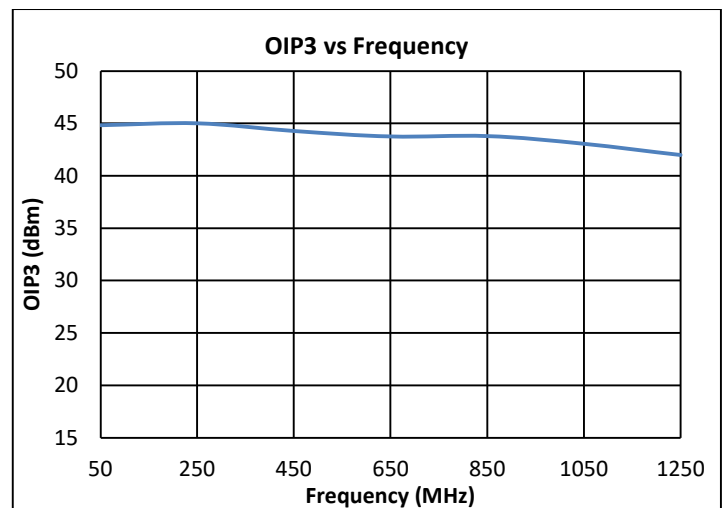
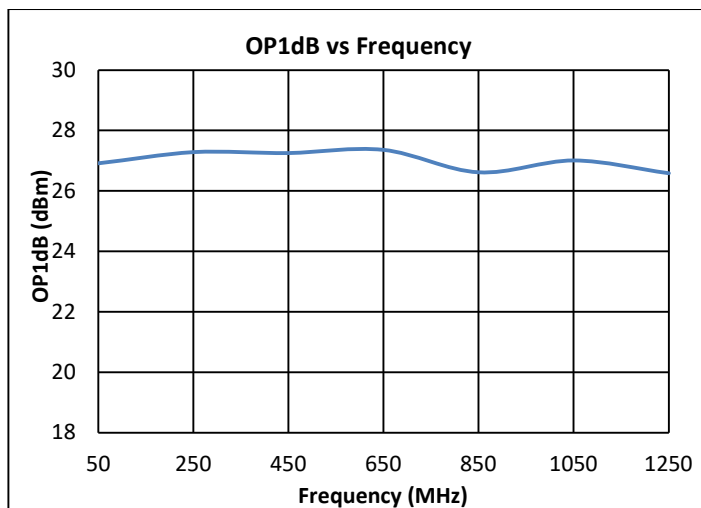
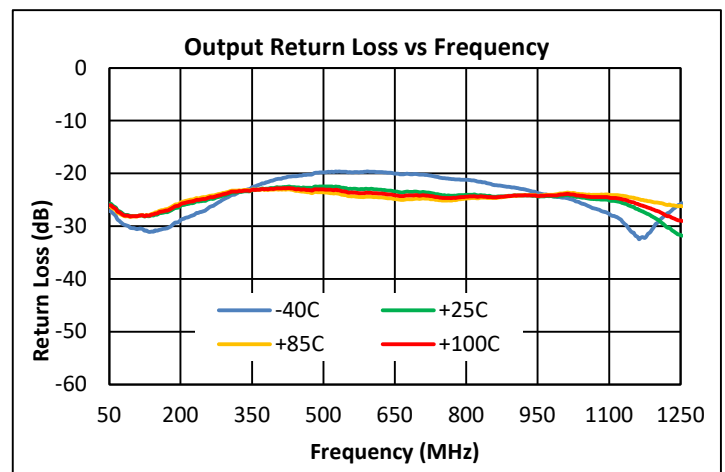
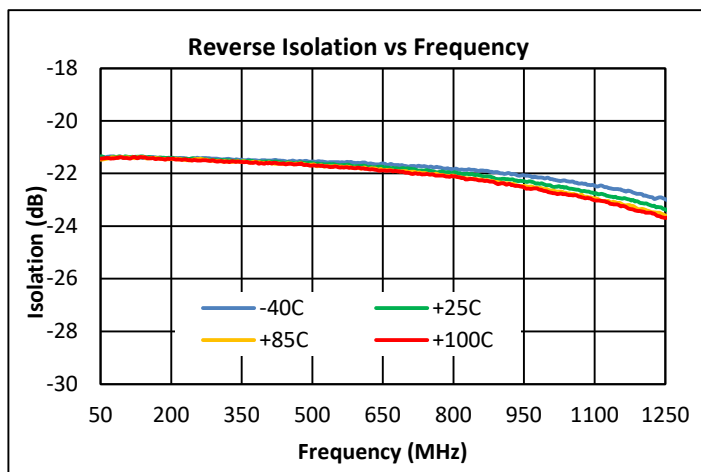
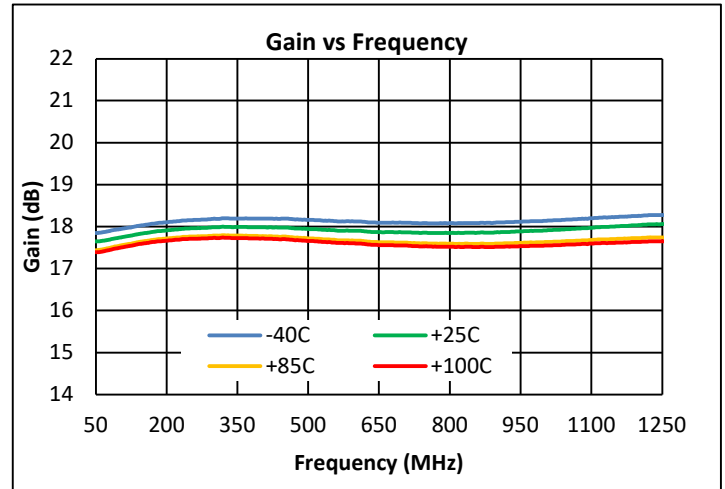
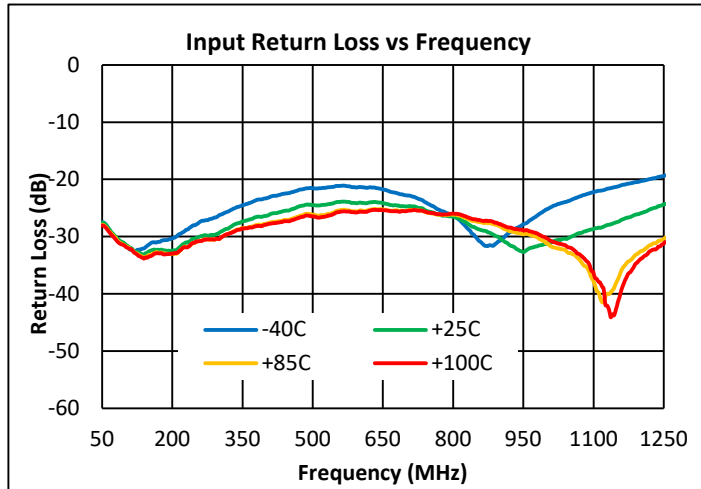

Note: OIP3: +13 dBm / tone output, Δf = 6 MHz, 50-1218 MHz

### Performance Data for Downstream (5V, 50-1218 MHz)

Test conditions unless otherwise noted: V<sub>dd</sub> = +5V, Temp = +25C, Z<sub>o</sub> = 75Ω

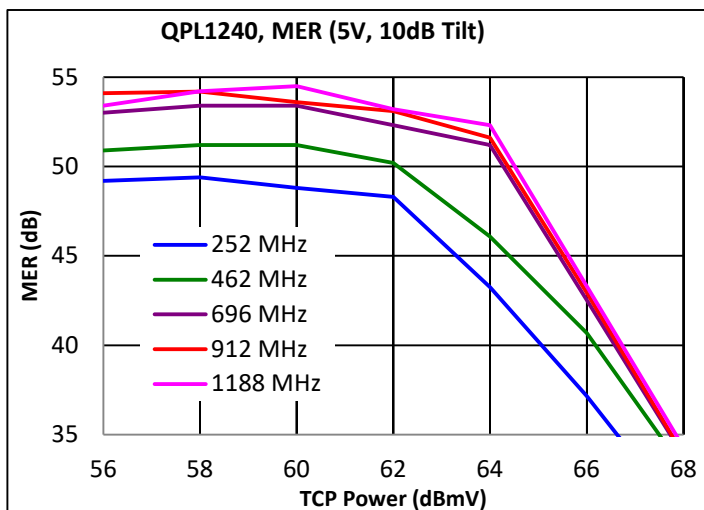
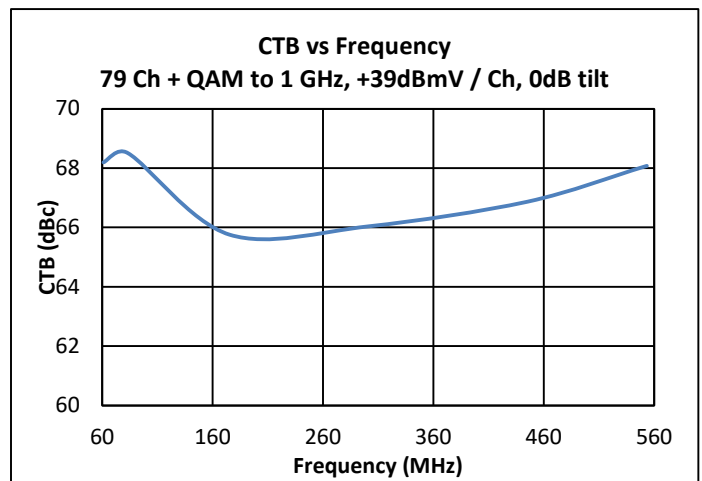
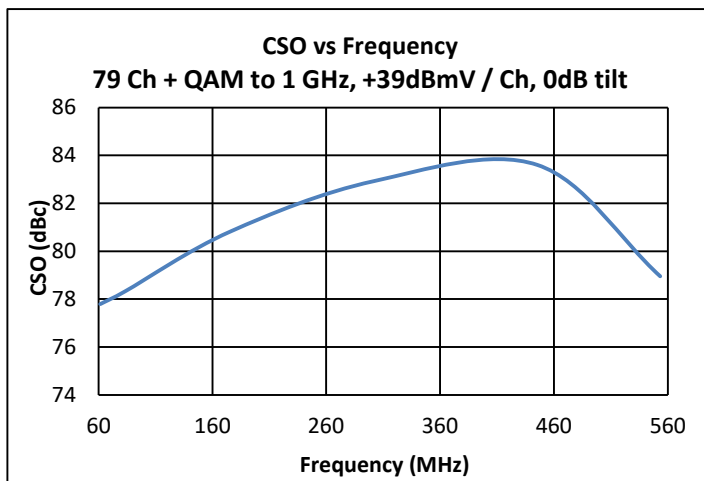
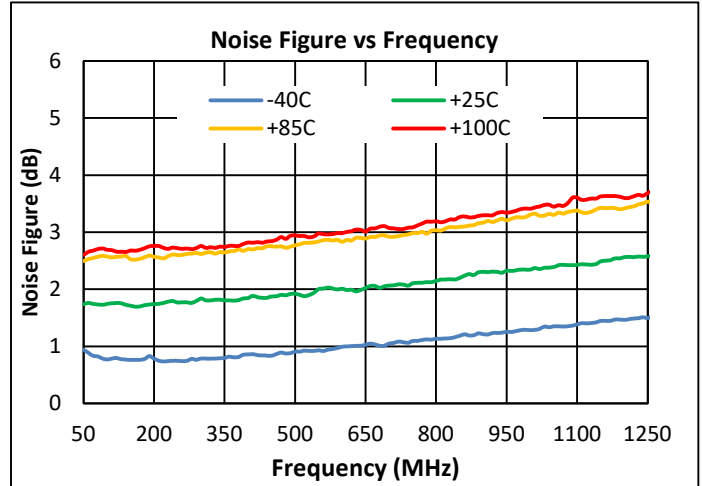
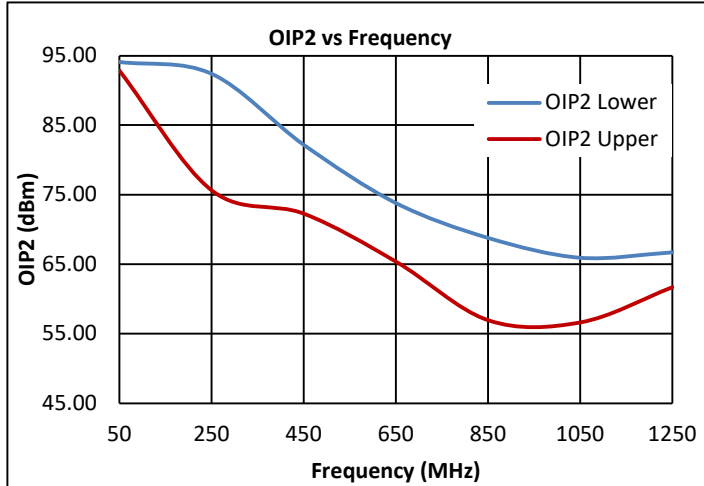

Notes: 1. OIP2: +13 dBm / tone output, Δf = 53 MHz, 50-1218 MHz

2. MER data is source corrected, 10dB Tilt

### Performance Data for Downstream (8V, 50-1218 MHz)

Test conditions unless otherwise noted: V<sub>dd</sub> = +8V, Temp = +25C, Z<sub>o</sub> = 75Ω

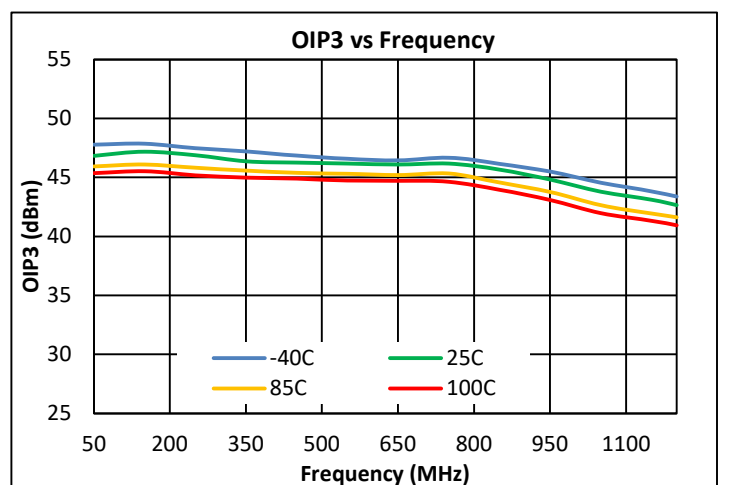
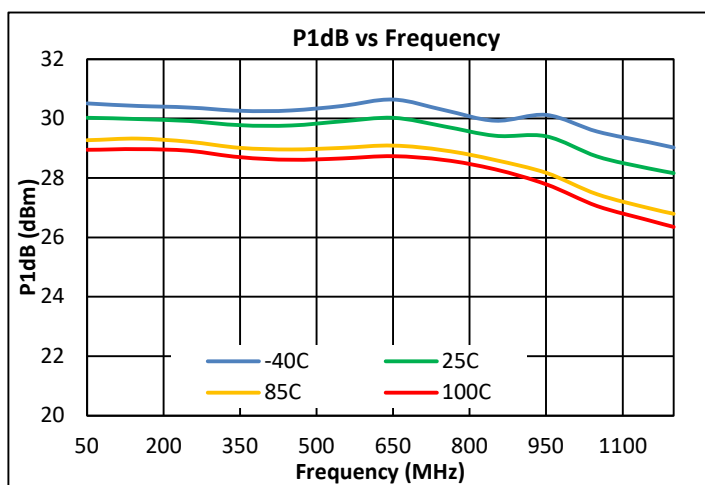
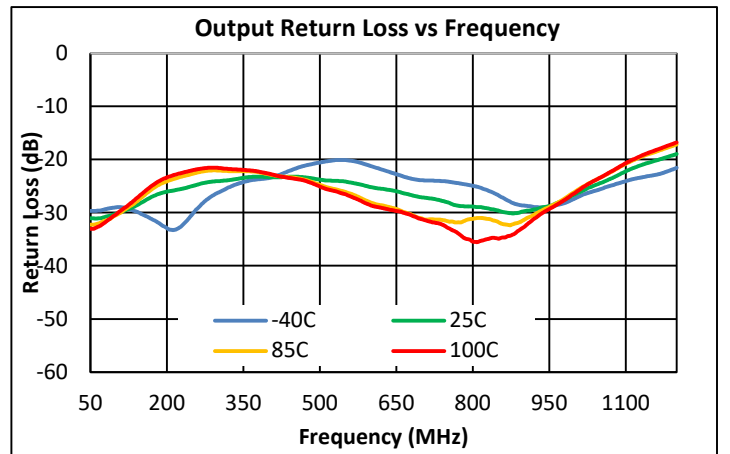
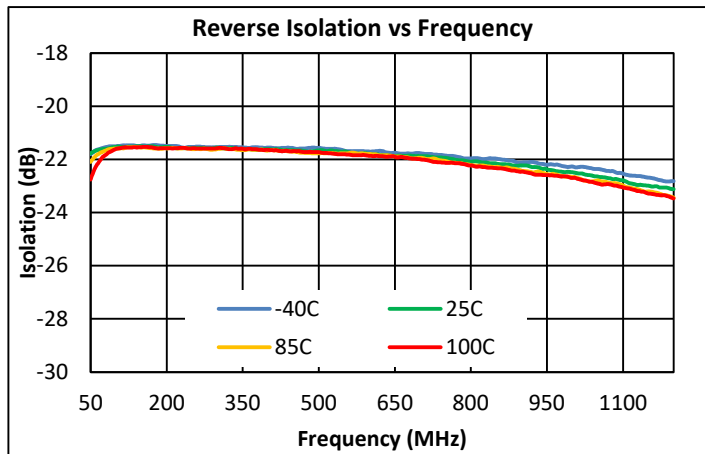
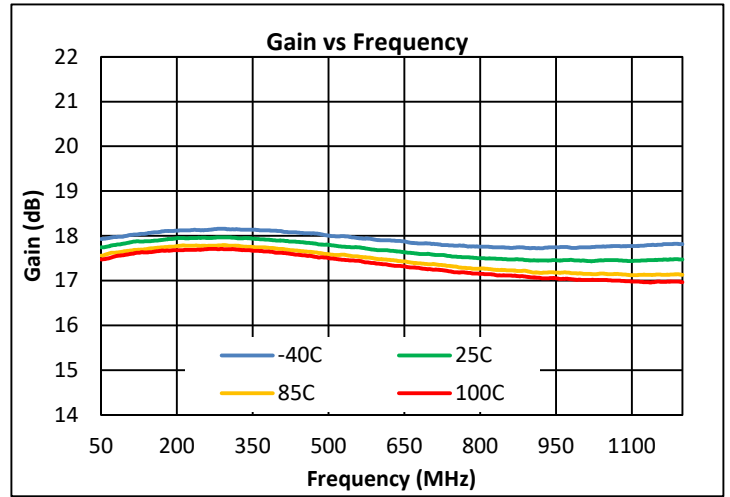
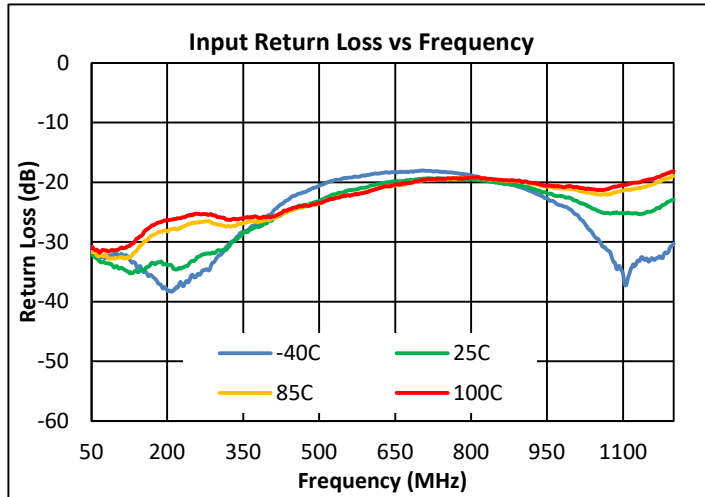

Notes: 1. OIP3 +13dBm / tone output. Δf = 6 MHz, 50-1218 MHz

### Performance Data for Downstream (8V, 50-1218 MHz)

Test conditions unless otherwise noted: V<sub>dd</sub> = +8V, Temp = +25C, Z<sub>o</sub> = 75Ω

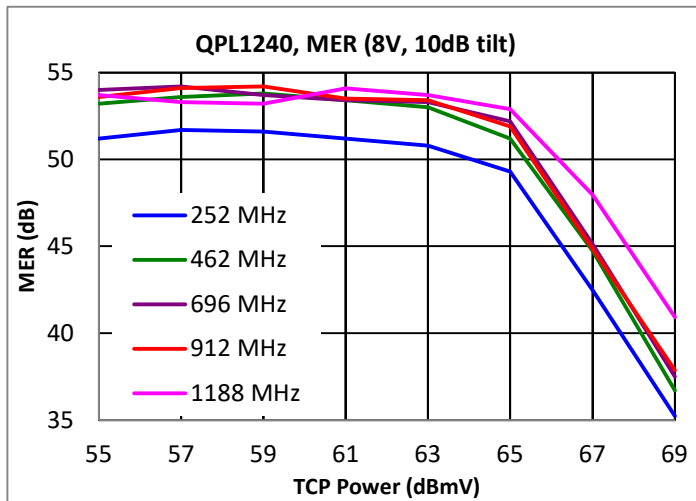
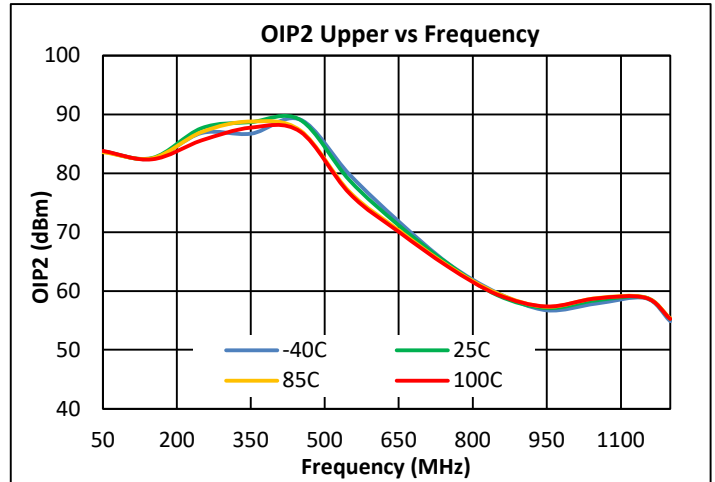
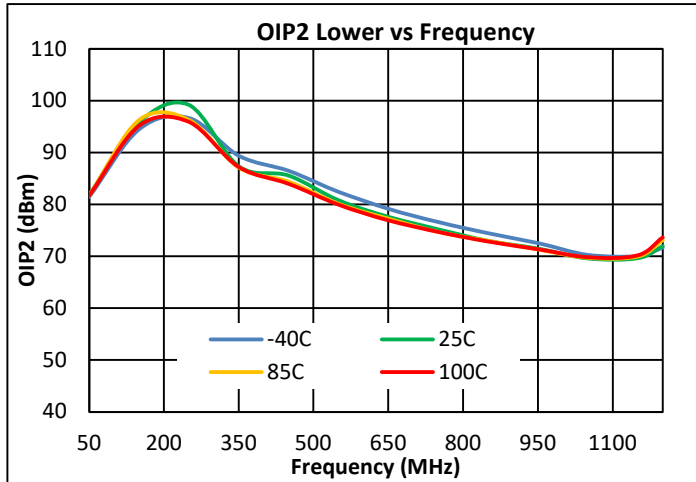

Notes: 1. OIP2: +13 dBm / tone output, Δf = 53 MHz, 50-1218 MHz

2. MER data is source corrected, 10dB Tilt



### Evaluation Board Schematic for Upstream (5V, 5 – 300MHz)

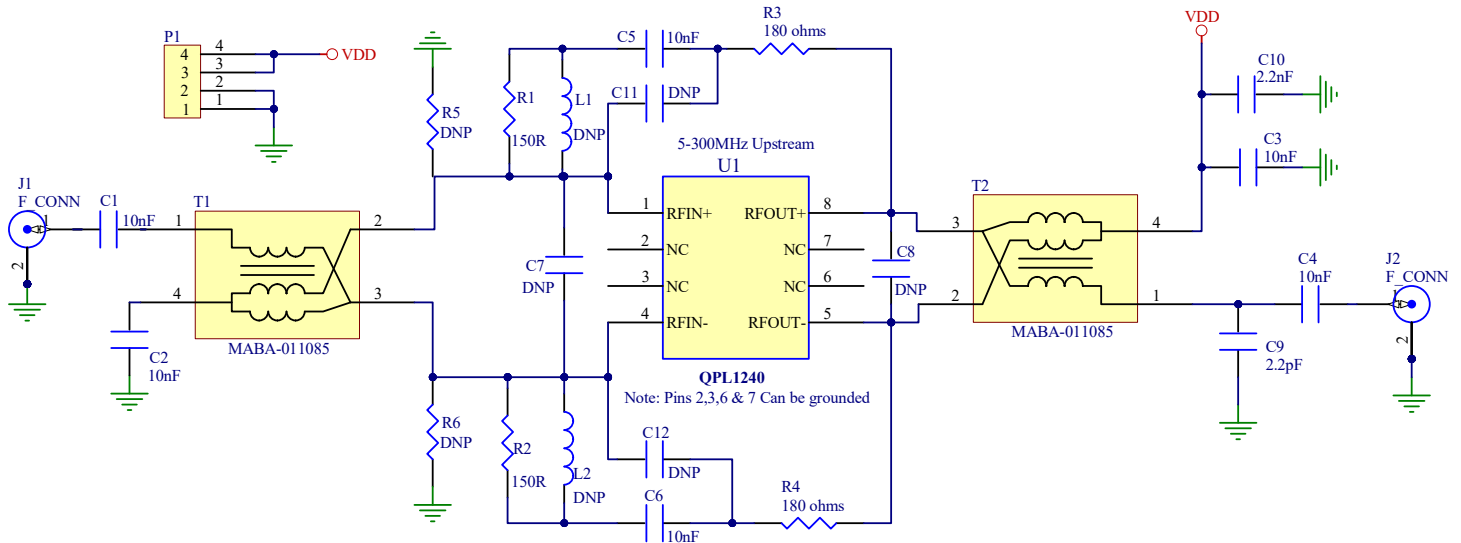

### Bill of Material for Upstream (5V, 5 – 300MHz)

Reference Designator	Description	Manufacturer	Part Number
U1	1218 MHz, 19 dB Push-Pull Amp	Qorvo	QPL1240SB
PCB	EVB PCB, QPL1163/1240	Qorvo	SAP # 302353
C1, C2, C3, C4, C5, C6	CAP, 0.01uF, 5%, 50 V, 0402	Murata	GRM155R11H103JA88
C10	CAP, 2.2nF, 5%, 50V, 0402	Murata	GRM155R11H222JA01
C9	CAP, 2.2pF, +/-0.1pF, 50V, HI-Q, 0402	Murata	GRM0223C1H2R2BA0
R1, R2	RES, 150 OHM, 5%, 1/16W, 0402	Kamaya	RMC1/16S-151JTH
R3, R4	RES, 180 OHM, 5%, 1/16W, 0402	Kamaya	RMC1/16S-181JTH
T1, T2	BALUN, 1:1	MACOM	MABA-0011085
T1, T2 (Alternate vendor)	BALUN, 1:1	Mini-RF	MRFXF5R09
P1	CONN, HDR	Samtec	TSW-103-07-G-S
J1, J2	CONN, F FEM, 75OHM	Millimeter Wave	MW-846-C-DD-75
Heatsink	HEATSINK, 50 x 50 x10, ALUMINUM	Alpha Nova Tech	S08EFV05-A
L1, L2, C7, C8, C11, C12, R5, R6	DNP		

- For 8V operation, populate R5 & R6 with 12K Ohm Resistors

### Performance Data for Upstream (5V, 5-300 MHz)

Test conditions unless otherwise noted: V<sub>dd</sub> = +5V, Temp = +25C, Z<sub>o</sub> = 75Ω

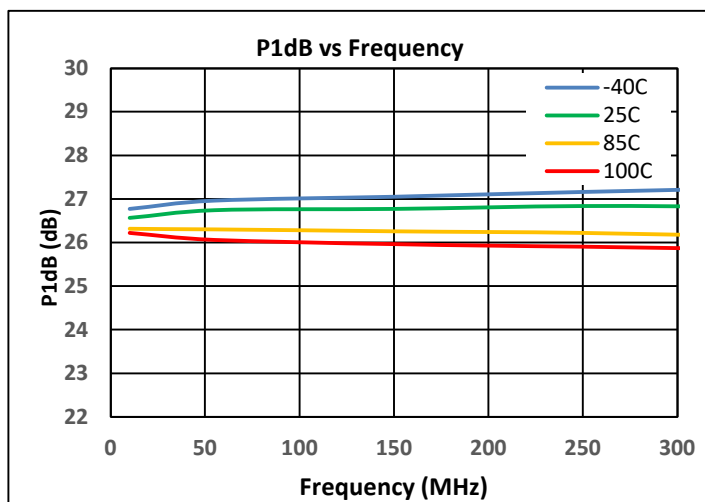
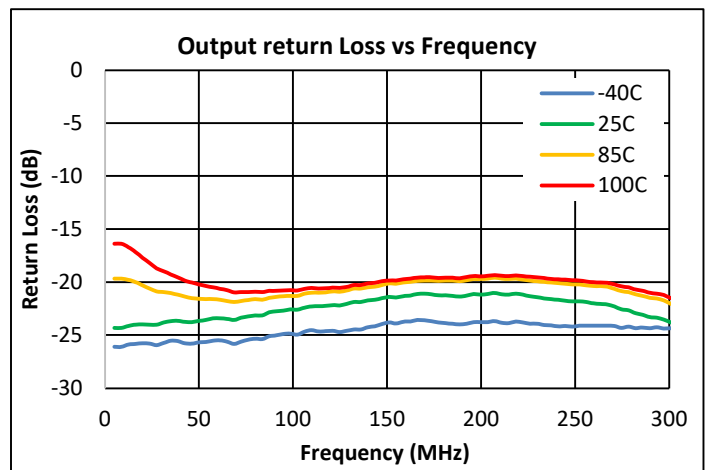
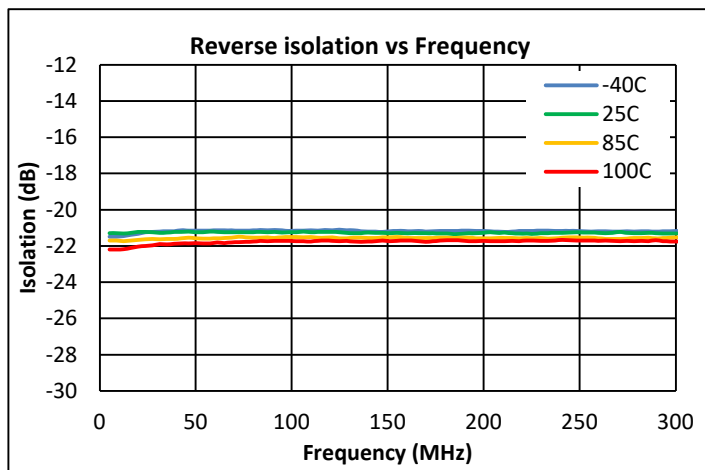
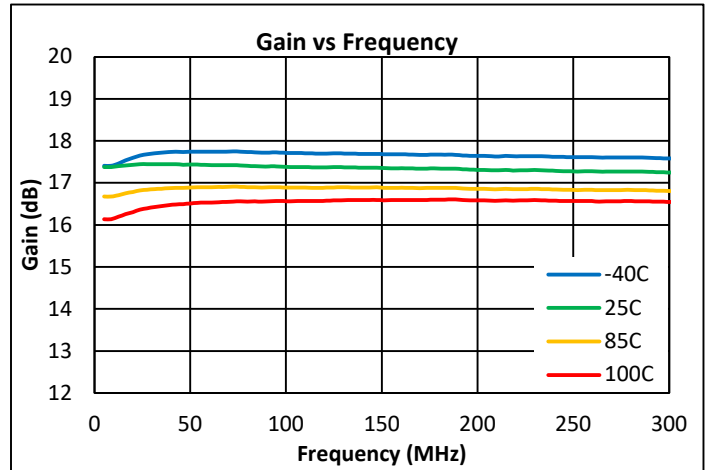
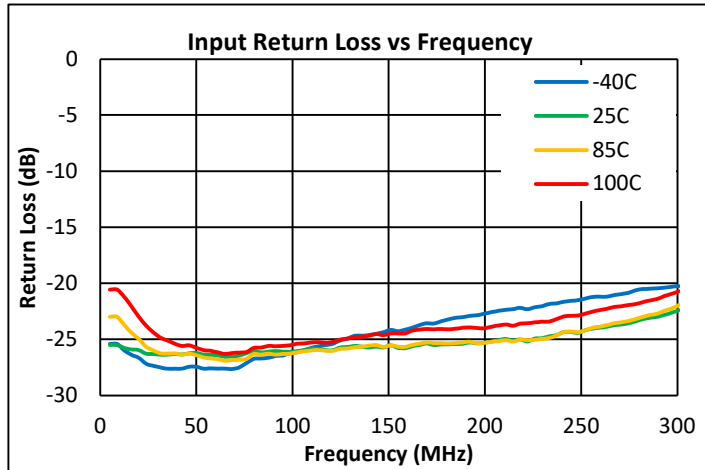

### Performance Data for Upstream (5V, 5-300 MHz)

Test conditions unless otherwise noted: Vdd = +5V, Temp = +25C, Zo = 75 $\Omega$

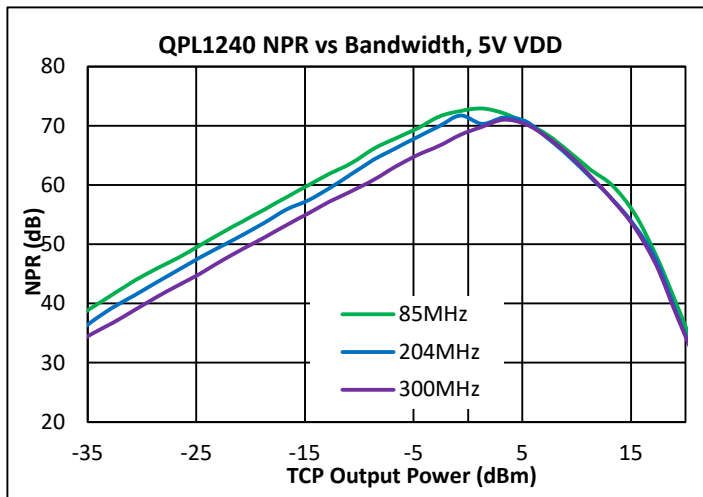
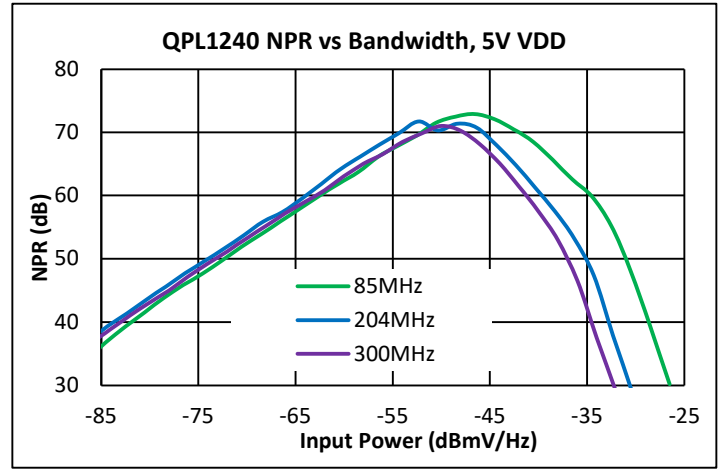
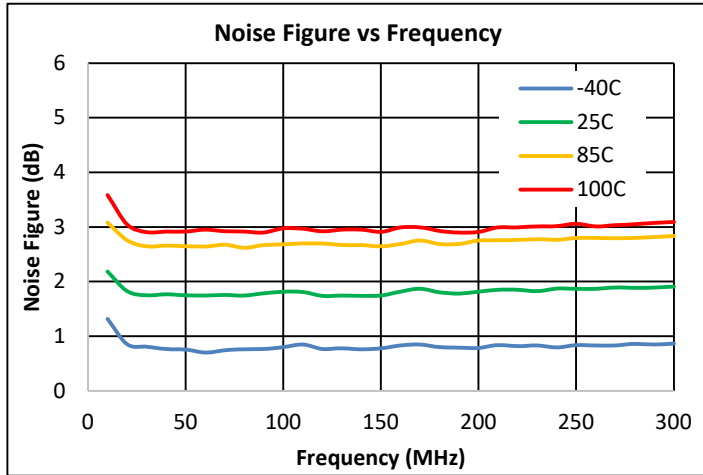



### Electrical Specifications for Upstream (5-700MHz)

Parameter	Condition <sup>(1)</sup>	Min	Typ	Max	Unit
Supply Voltage ( $V_{DD}$ )			5/8		V
Supply Current ( $I_{DD}$ )	$V_{DD}$ total current		275/330		mA
Frequency Range		5		700	MHz
Gain	5 – 700 MHz		17.8		dB
Gain Flatness	5 – 700 MHz		0.25		dB
Input Return Loss	5 – 700 MHz		18		dB
Output Return Loss	5 – 700 MHz		18		dB
Noise Figure	5 – 700 MHz		1.5		dB
Output P1dB	5 – 700 MHz		27		dBm
Thermal Resistance	Junction to case		20		$^{\circ}\text{C}/\text{W}$

#### Notes:

1. Typical performance at these conditions: Temp = +25  $^{\circ}\text{C}$ ,  $V_{DD}$  = +5V, 75  $\Omega$  system, Full band unless otherwise noted.
2. Upstream (Reverse Path) Freq Range is 5-700 MHz

### Evaluation Board Schematic for Upstream (5V, 5 – 700MHz)

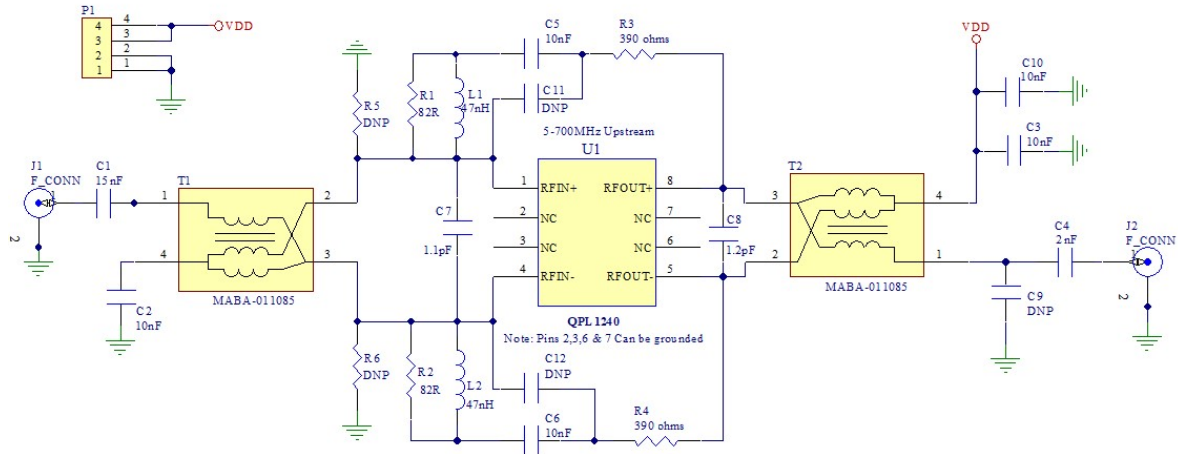

### Bill of Material for Upstream (5V, 5 – 700MHz)

Reference Designator	Description	Manufacturer	Part Number
U1	1218 MHz, 19 dB Push-Pull Amp	Qorvo	QPL1240SB
PCB	EVB PCB, QPL1163/1240	Qorvo	SAP # 302353
C1, C2, C3, C4, C5, C6, C10	CAP, 0.01uF, 5%, 50 V, 0402	Murata	GRM155R11H103JA88
C7	CAP, 1.1pF, +/-0.25pF, 50V, Hi-Q,0402	Murata	GJM1555C1H1R1CB01D
C8	CAP, 1.2pF, +/-0.25pF, 50V, Hi-Q,0402	Murata	GJM1555C1H1R2CB01D
R1, R2	RES, 82 OHM, 5%, 1/16W, 0402	Kamaya	RMC1/16S-820JTH
R3, R4	RES, 390 OHM, 5%, 1/16W, 0402	Kamaya	RMC1/16S-391JTH
T1, T2	BALUN, 1:1	MACOM	MABA-0011085
L1, L2	IND 47nH, 5%, M/L, 0402	Murata	LQG15HN47NJ02D
P1	CONN, HDR	Samtec	TSW-103-07-G-S
J1, J2	CONN, F FEM, 75OHM	Millimeter Wave	MW-846-C-DD-75
Heatsink	HEATSINK, 50 x 50 x10, ALUMINUM	Alpha Nova Tech	S08EFV05-A
C9, C11, C12, R5, R6	DNP		

• For 8V operation

R5, R6	RES, 12K OHM, 1%, 1/10W, 0402	KOA peer	RK73H1ETTP1202F
C1	CAP, 15000pF, 10%, 16V, X7R, 0402	Kemet	C0402C153K4RACAUTO
C4	CAP, 2000pF, 5%, 50V, X7R, 0402	AVX	04025C202JAT2A

### Performance Data for Upstream (5V, 5-700 MHz)

Test conditions unless otherwise noted: Vdd = +5V, Temp = +25C, Zo = 75Ω

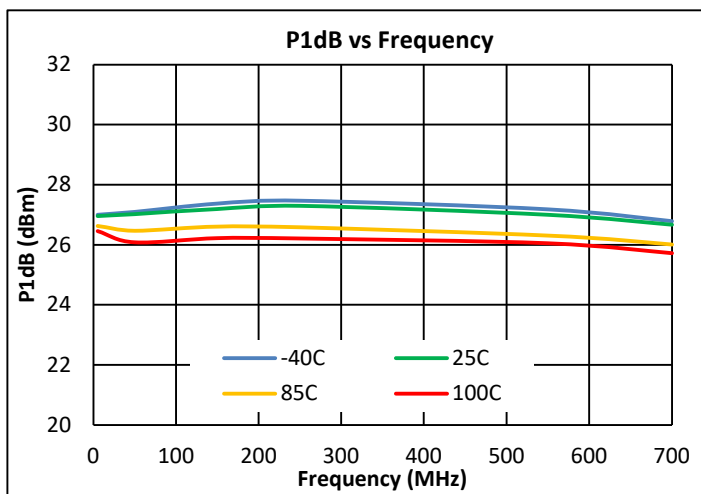
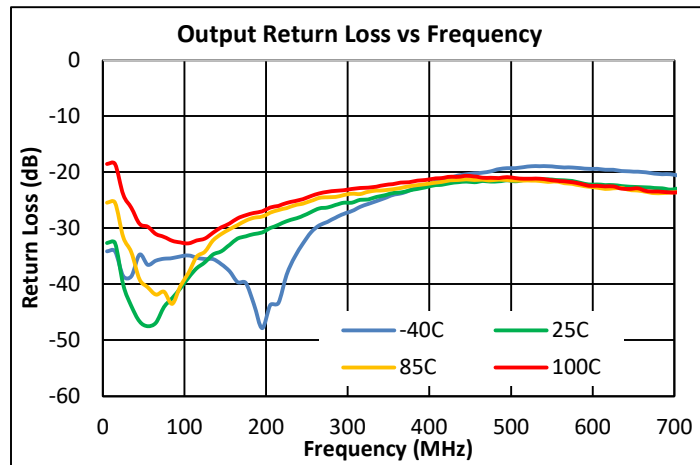
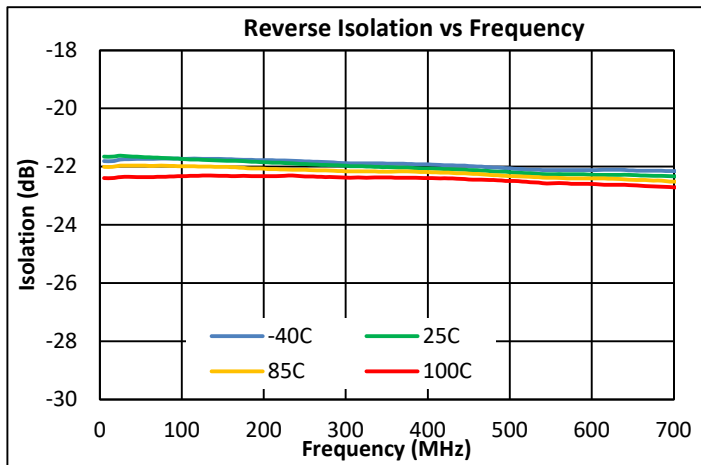
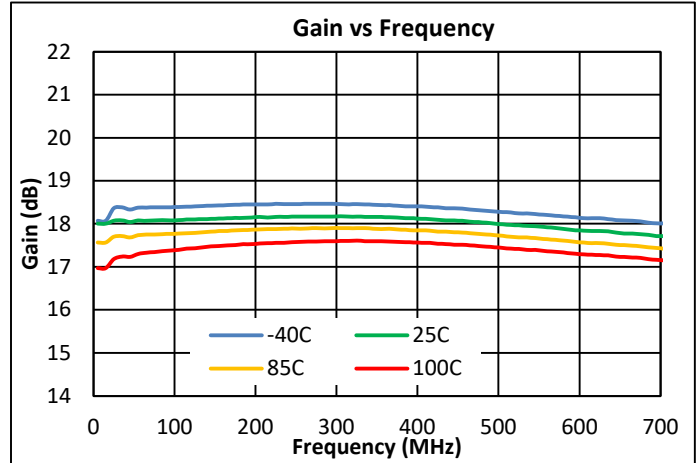
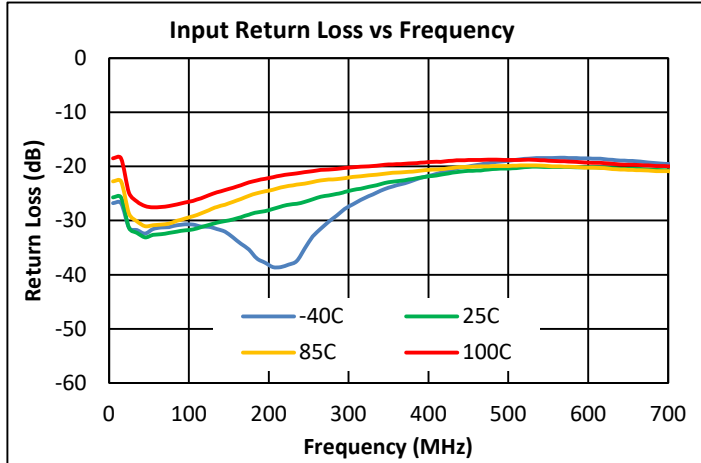

### Performance Data for Upstream (8V, 5-700 MHz)

Test conditions unless otherwise noted: V<sub>dd</sub> = +8V, Temp = +25C, Z<sub>o</sub> = 75Ω

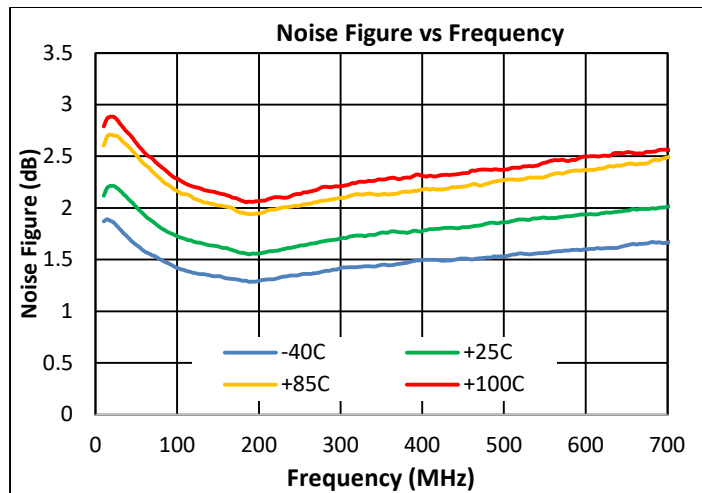
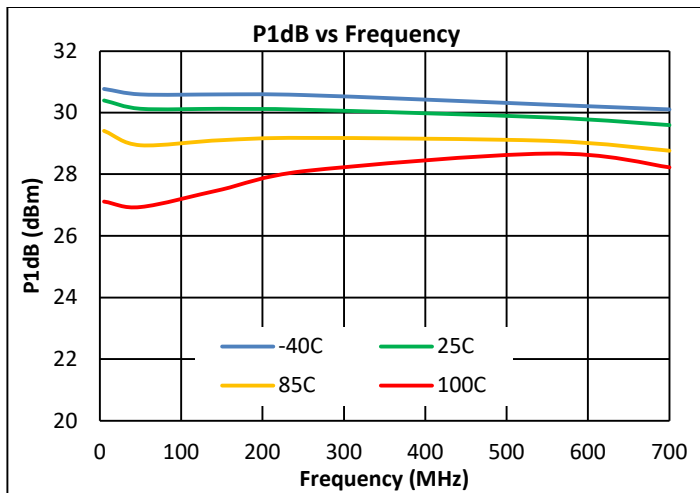
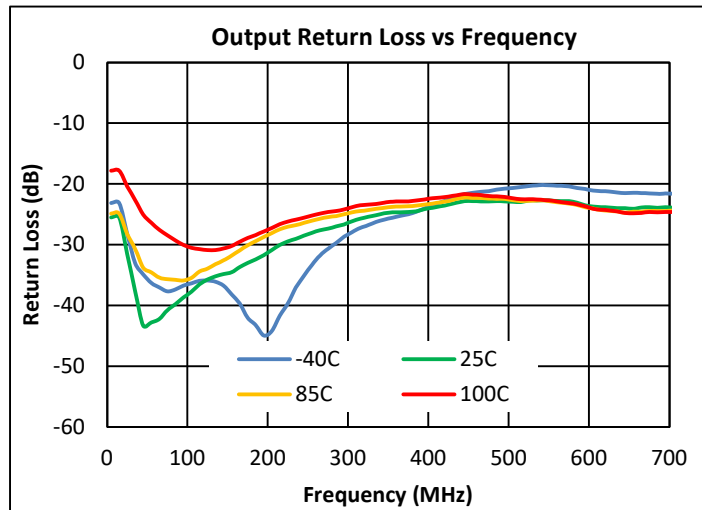
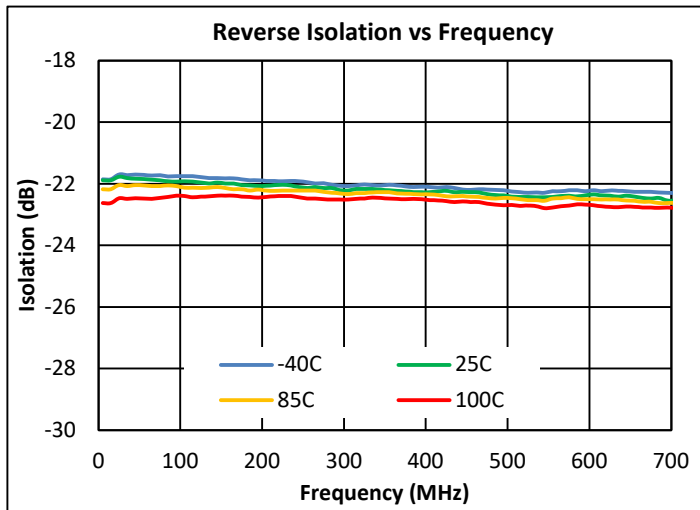
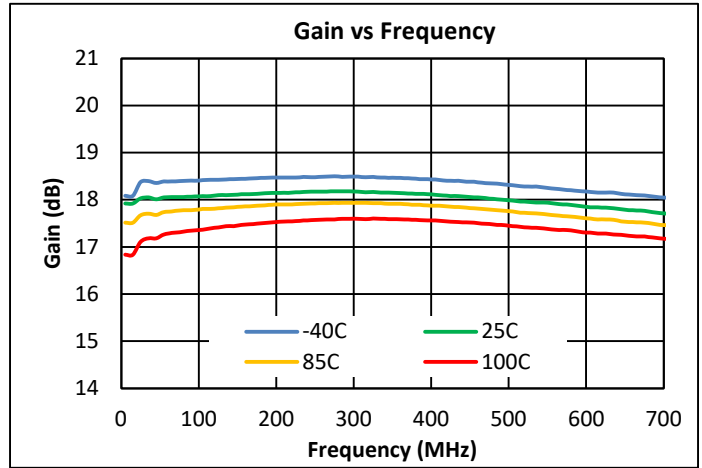
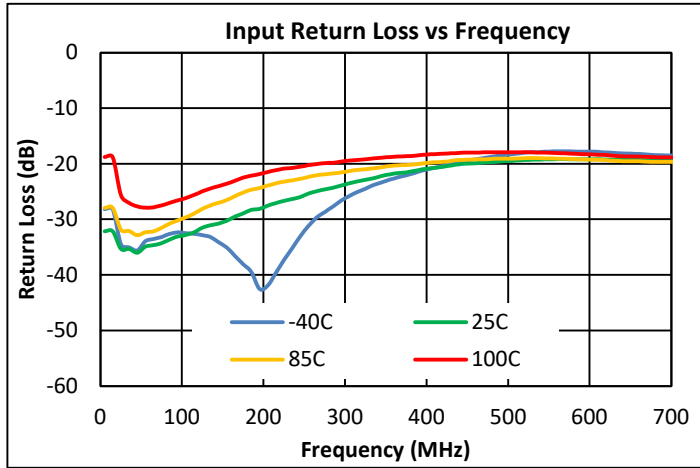

### Pin Configuration and Description

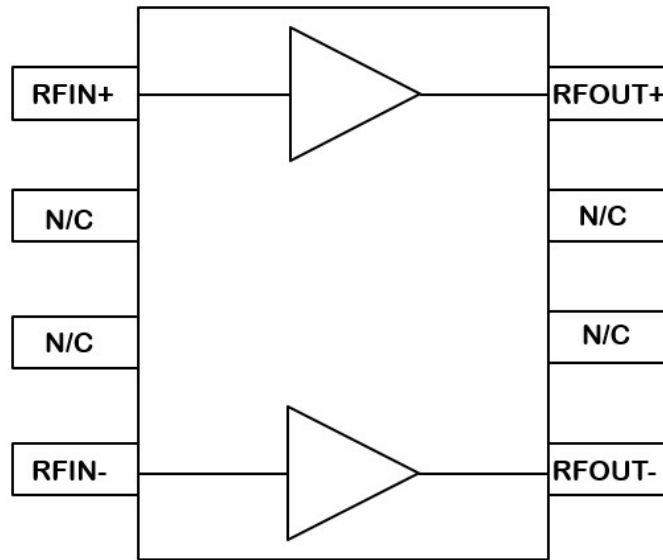

**SOIC-8 EP Package**

Pin	Name	Description
1	RFIN+	RF input for plus side of amplifier
2	N/C	No Internal Connection - (Pin can be grounded)
3	N/C	No Internal Connection - (Pin can be grounded)
4	RFIN-	RF input for minus side of amplifier
5	RFOUT-	RF output for minus side of amplifier, Vdd (requires bias choke)
6	N/C	No Internal Connection - (Pin can be grounded)
7	N/C	No Internal Connection - (Pin can be grounded)
8	RFOUT+	RF output for plus side of amplifier, Vdd (requires bias choke)
Slug	GND	RF, DC, and Thermal Ground



#### Package Marking

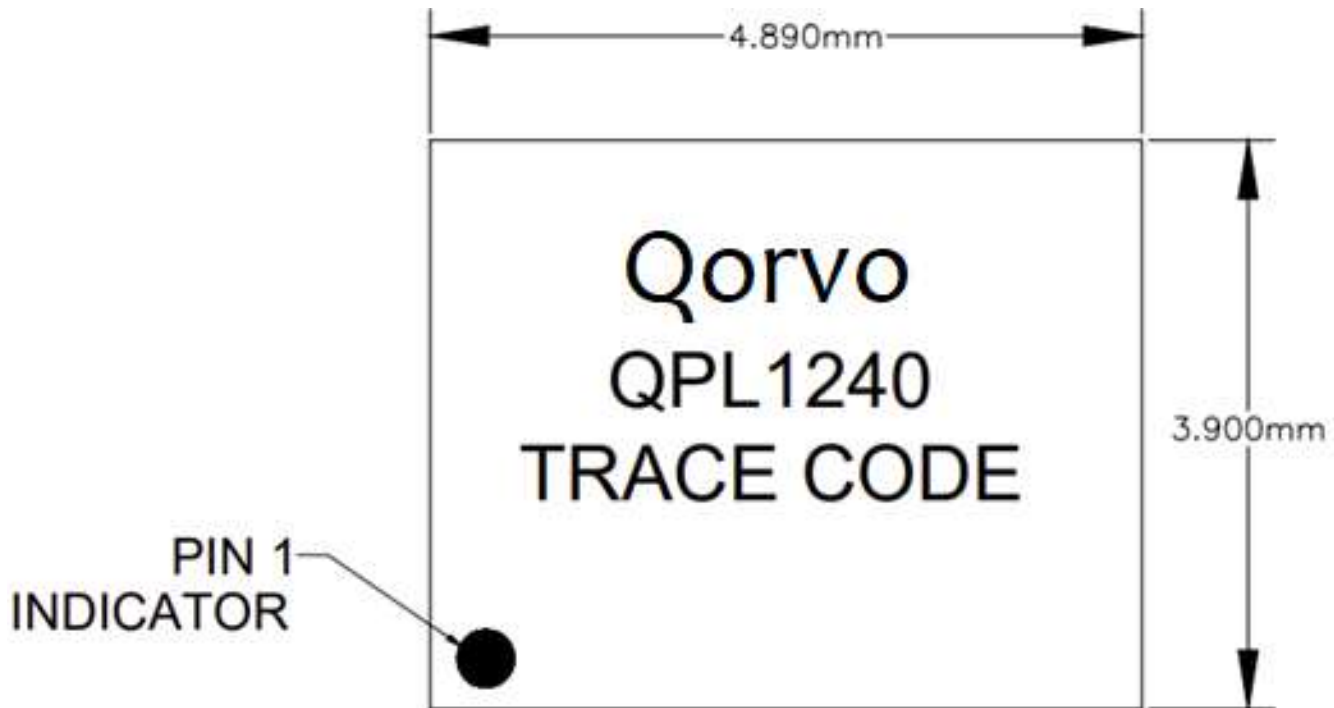

#### NOTES:

LINE 1: QPL1240

LINE 2: TRACE CODE.

TRACE CODE TO BE  
ASSIGNED BY SUBCON.

#### Package Outline

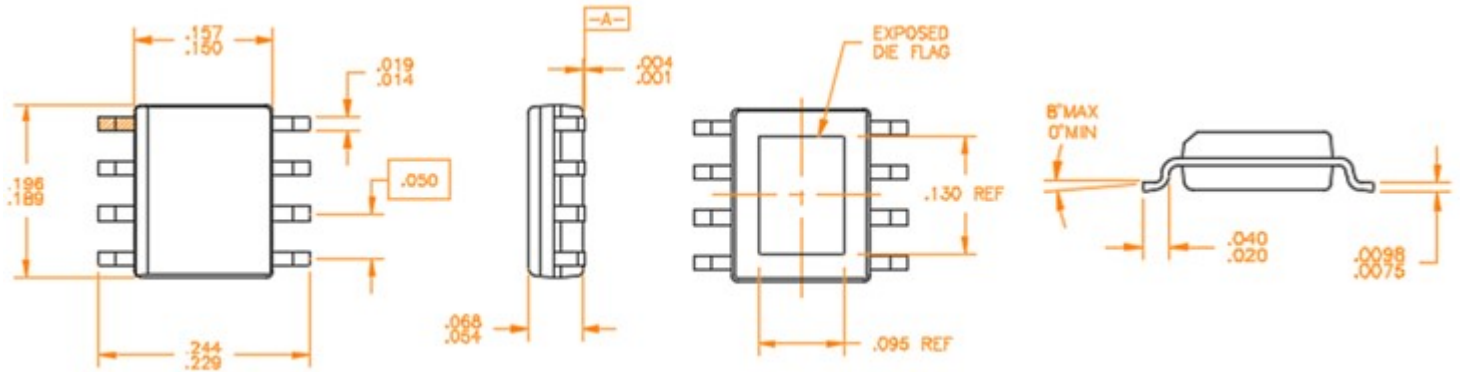

**Notes:**

1. All Dimensions are in inches.
2. Angles are in degrees.

#### Recommended PCB Land Pattern

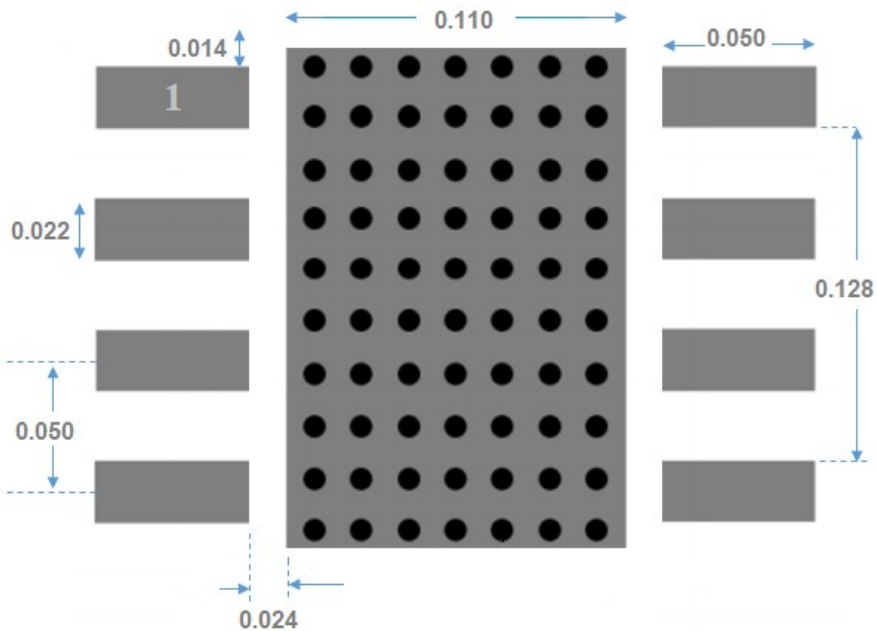

**Notes:** All dimensions are in inches.

1. Use 1 oz. copper minimum for top and bottom layer metal.
2. Vias are required under the backside paddle for proper RF/DC grounding and thermal dissipation.
3. Recommend about 70 vias of 8mil diameter as shown in the land pattern.