

Product Overview

The QPL1816 is a GaAs pHEMT single ended RF amplifier IC featuring 10dB of gain and low noise. The balance of low noise and distortion provides an ideal solution for a wide range of broadband amplifiers used in Cable TV applications such as Optical Receivers and low noise front ends. QPL1816 is packaged in a SOT-89 package for convenient layout and design in set top and infrastructure projects for 75 Ω CATV and satellite applications.

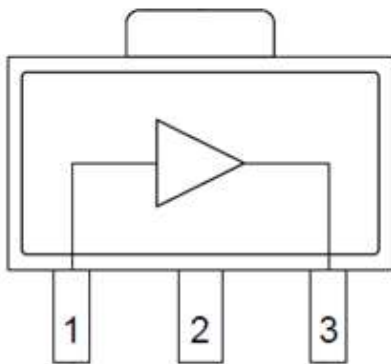

Functional Block Diagram



Top View

Key Features

- 50 MHz to 1800 MHz Operation
- 6 V Single Power Supply
- Gain: 10 dB Typical
- Noise Figure: 2.5 dB Typical at 1250 MHz
- Convenient SOT-89 Package
- RoHS Compliant

Applications

- FTTH GPON and GEPON
- DOCSIS 4.0
- Head End CMTS Equipment
- Optical Node
- Satellite Low Noise Amplifier
- Cable Modem and Set Top Box
- Single Ended Gain Block

Ordering Information

Part Number	Description
QPL1816SB	Sample bag with 5 pieces
QPL1816SR	7" Reel with 100 pieces
QPL1816TR13	13" Reel with 2500 pieces
QPL1816EVB-01	Evaluation Board



Absolute Maximum Ratings

Parameter	Rating
Supply Voltage (V_{DD})	+8 V
Supply Current (I_{DD})	170 mA
Maximum Input Level	60 dBmV
Operating Temperature Range	-40 to +100 °C
Storage Temperature Range	-65 to +150 °C
Maximum Junction Temperature	+150 °C

Exceeding any one or a combination of the Absolute Maximum Rating conditions may cause permanent damage to the device. Extended application of Absolute Maximum Rating conditions to the device may reduce device reliability.

Electrical Specifications at +6 V

Parameter	Condition ⁽¹⁾	Min	Typ	Max	Unit
Supply Voltage (V_{DD})			6		V
Supply Current (I_{DD})			120		mA
Frequency Range		50		1800	MHz
Gain			10		dB
Gain Flatness			± 1		dB
Reverse Isolation			17		dB
Input Return Loss			16		dB
Output Return Loss			16		dB
Noise Figure			2.5		dB
OIP2 (Lower)	0 dBm / tone output		60		dBm
OIP2 (Upper)	0 dBm / tone output		50		dBm
OIP3	0 dBm / tone output		36		dBm
OP1dB			19		dBm
Thermal Resistance	Θ_{JC}		+42		°C/W

Note: Typical performance at these conditions: Temp = +25 °C, V_{DD} = +6 V, 75 Ω system, Full band unless otherwise noted

Evaluation Board Schematic 50 MHz – 1800 MHz

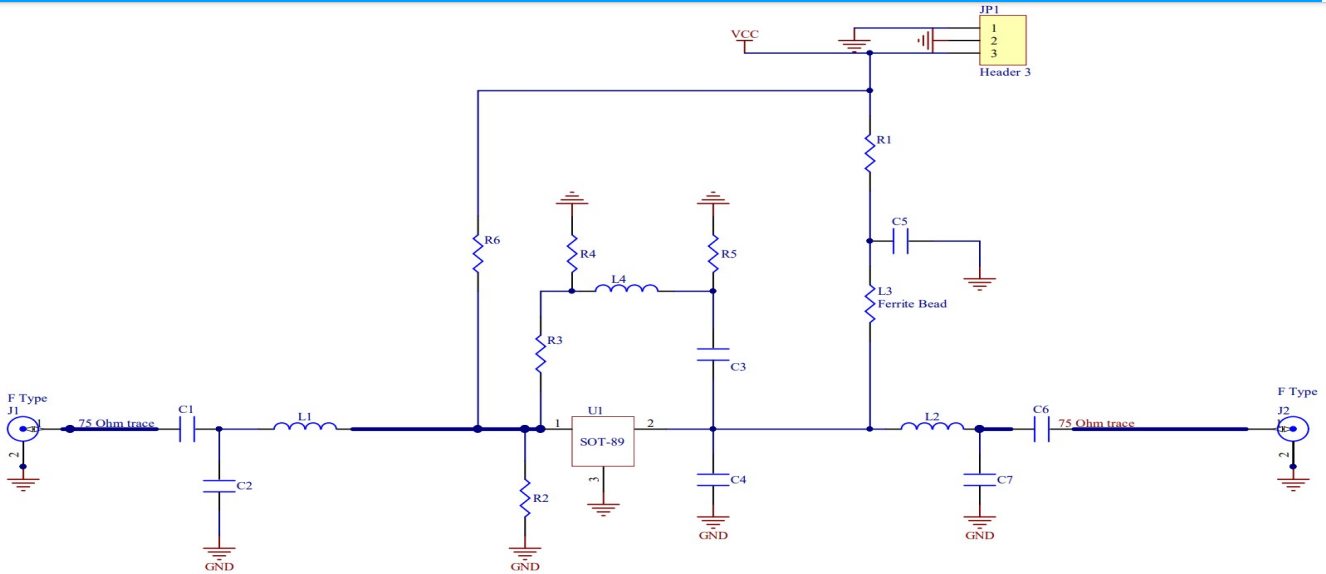

Evaluation Board Assembly Drawing

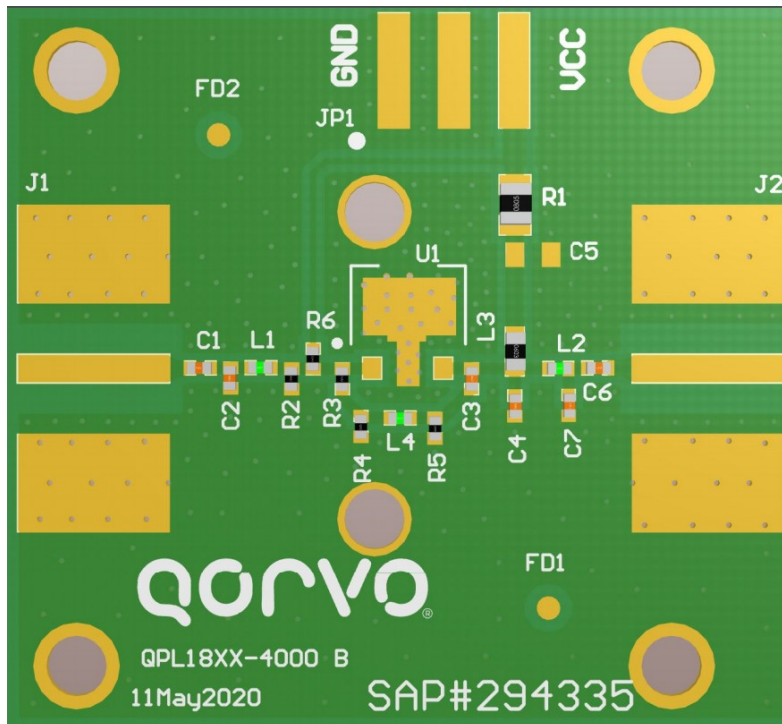



Evaluation Board Bill of Materials

Ref Des.	Description	Mfg Name	Mfg Part #
U1	CATV DOCSIS 4.0 LNA, 5V, 1.8GHz, 75-ohm	Qorvo	QPL1816
C5	CAP, 1000 PF, 50V, 10%, 0603	AVX Asia Limited	06035C102KAT2A
C7	CAP, 0.5pF, +/-0.25pF, 50V, HI-Q, 0402	MURATA ELECTRONICS	GJM1555C1HR50CB01D
C1, C6	CAP, 1000pF, 5%, 50V, C0G, 0402	MURATA ELECTRONICS	GRM1555C1H102JA01D
C2	CAP, 0.3pF, +/-0.05pF, 50V, HI-Q, 0402	MURATA ELECTRONICS	GJM1555C1HR30WB01D
R1	RES, 0 OHM, 0603	Kamaya, Inc	RMC1/16JPTP
L1	IND, 3.9nH, +/-0.3nH, M/L, 0402	MURATA ELECTRONICS	LQG15HN3N9S02D
L2	IND, 4.3nH, +/-0.1nH, T/F, 0402	MURATA ELECTRONICS	LQP15MN4N3B02D
L3	FER, BEAD, 1500 OHM, 500mA, 0603	MURATA ELECTRONICS	BLM18HE152SN1D
JP1	CONN, HDR, ST, 3-PIN, 0.100"	SAMTEC INC.	TSW-103-07-G-S
J1, J2	CONN, F FEM EDGE MOUNT, 75 OHMS, 0.068"	Millimeter Wave Tech	MW-846-C-DD-75
R2, R6, R3, R4, R5, C3, C4, L4	NOT POPULATED ITEM-1		DUMMY PART



Performance Data at +6V

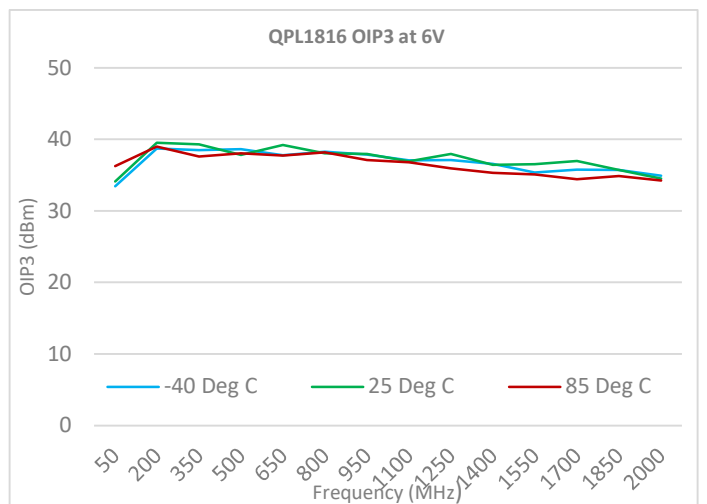
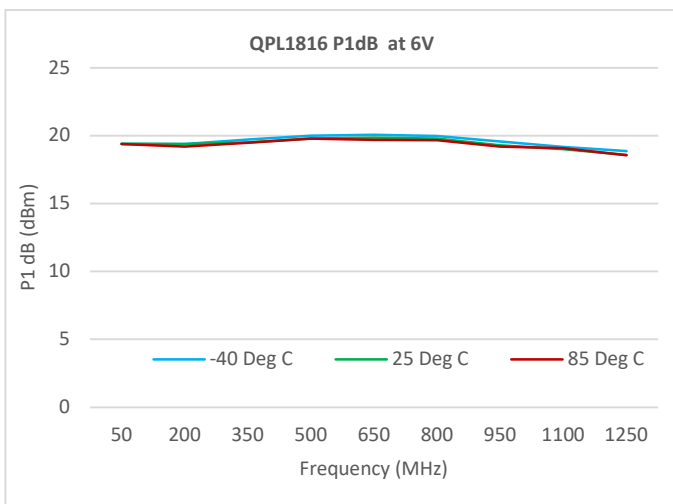
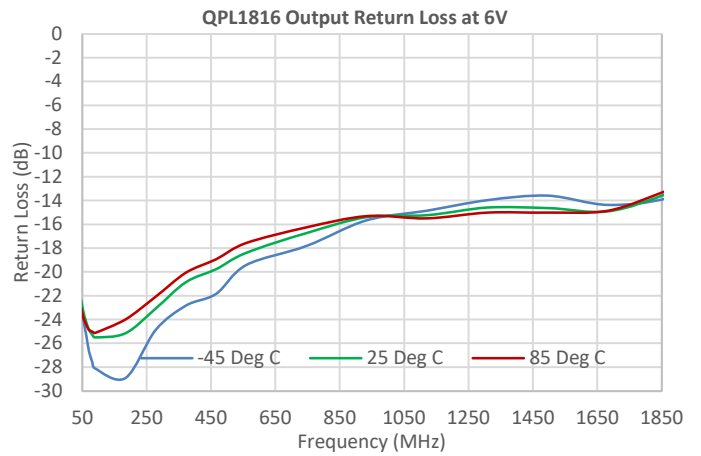
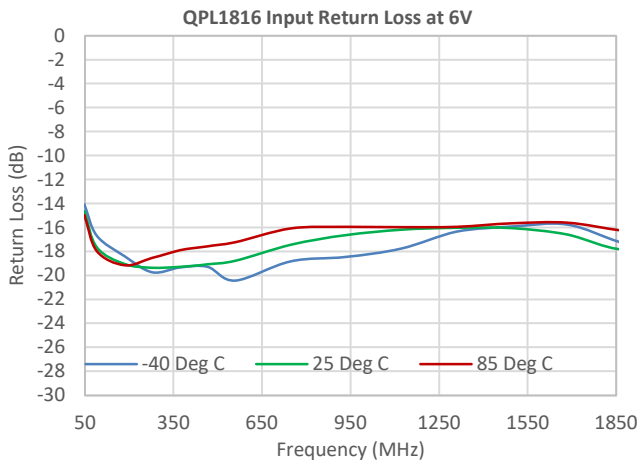
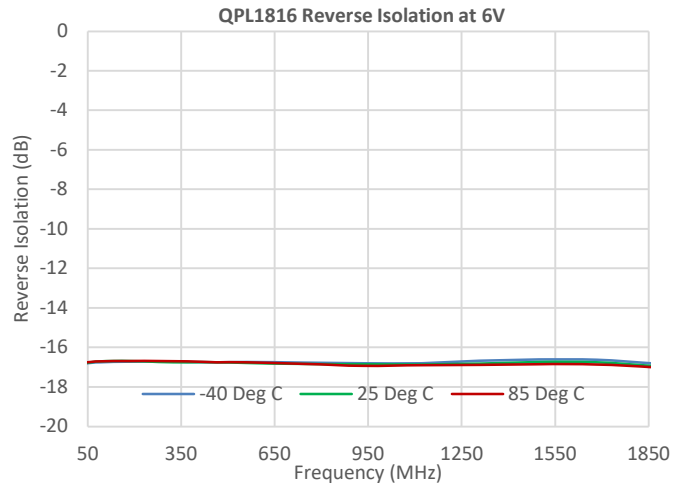
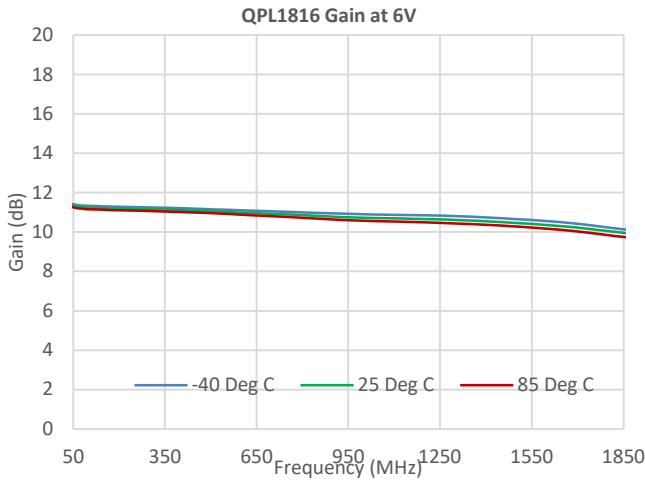

Notes: (1) OIP3: 0dBm/tone output



Performance Data at +6 V

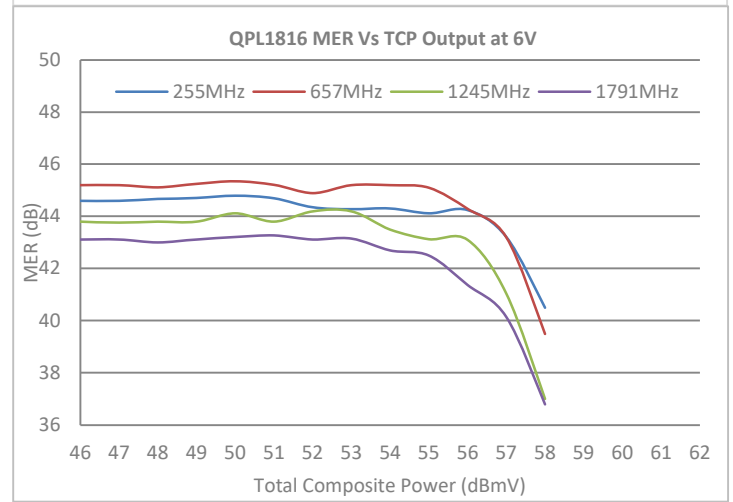
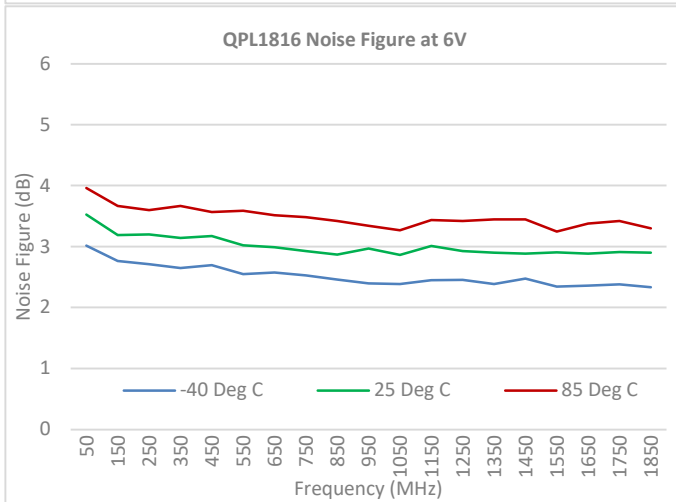
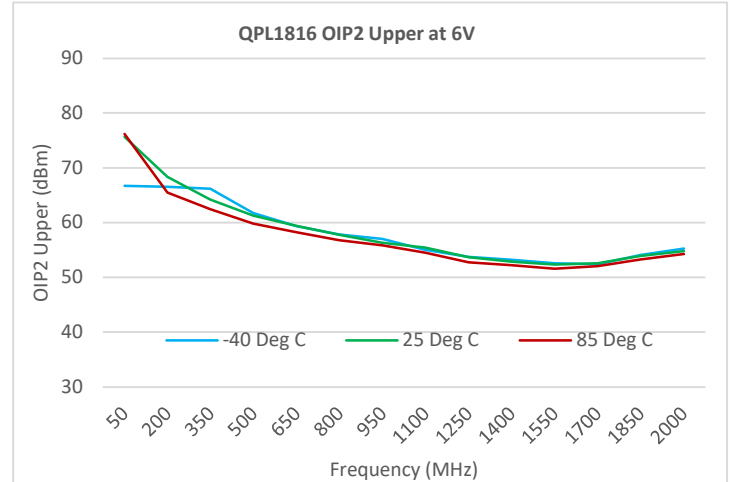
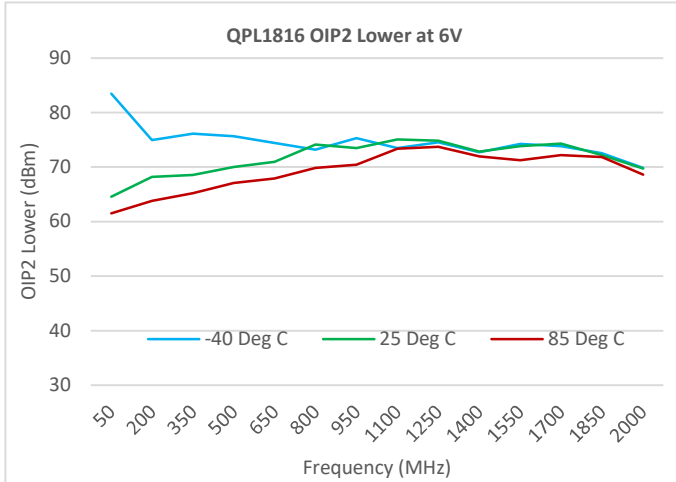

Notes:

- (1) OIP2: 0 dBm/ tone output
- (2) 54MHz to 1794MHz, 0dB tilt, 1 OFDM (54-246MHz) + 254 QAM (252-1794MHz) Channels.
CCN Noise BW (ANSI/SCTE 17): 5.36MHz for J.83/B.
- (3) Tx Data: ITU-T, Annex B, QAM256, 5.36 MSymbols/s

Pin Configuration and Description

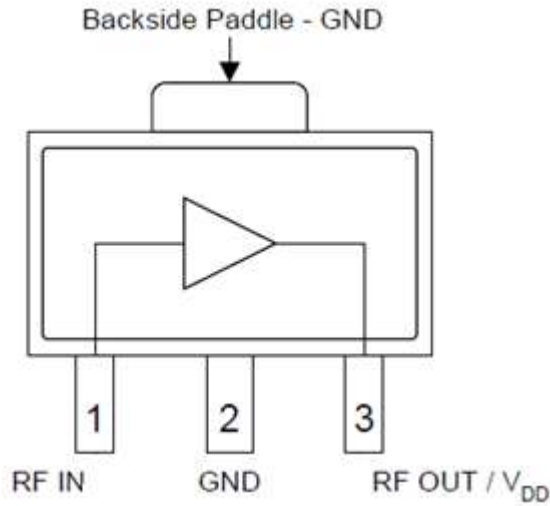

Top View

Pin Number	Label	Description
1	RF IN	RF Input, DC blocking capacitor required
2	GND	Internally Not Connected
3	RF OUT / VDD	RF Output – VDD bias choke required
Backside Paddle	GND	Ground. Use recommended via pattern to minimize inductance and thermal resistance. See PCB Mounting Pattern for suggested footprint.

Package Outline

NOTES:

1. SHADED LEAD IS PIN 1.

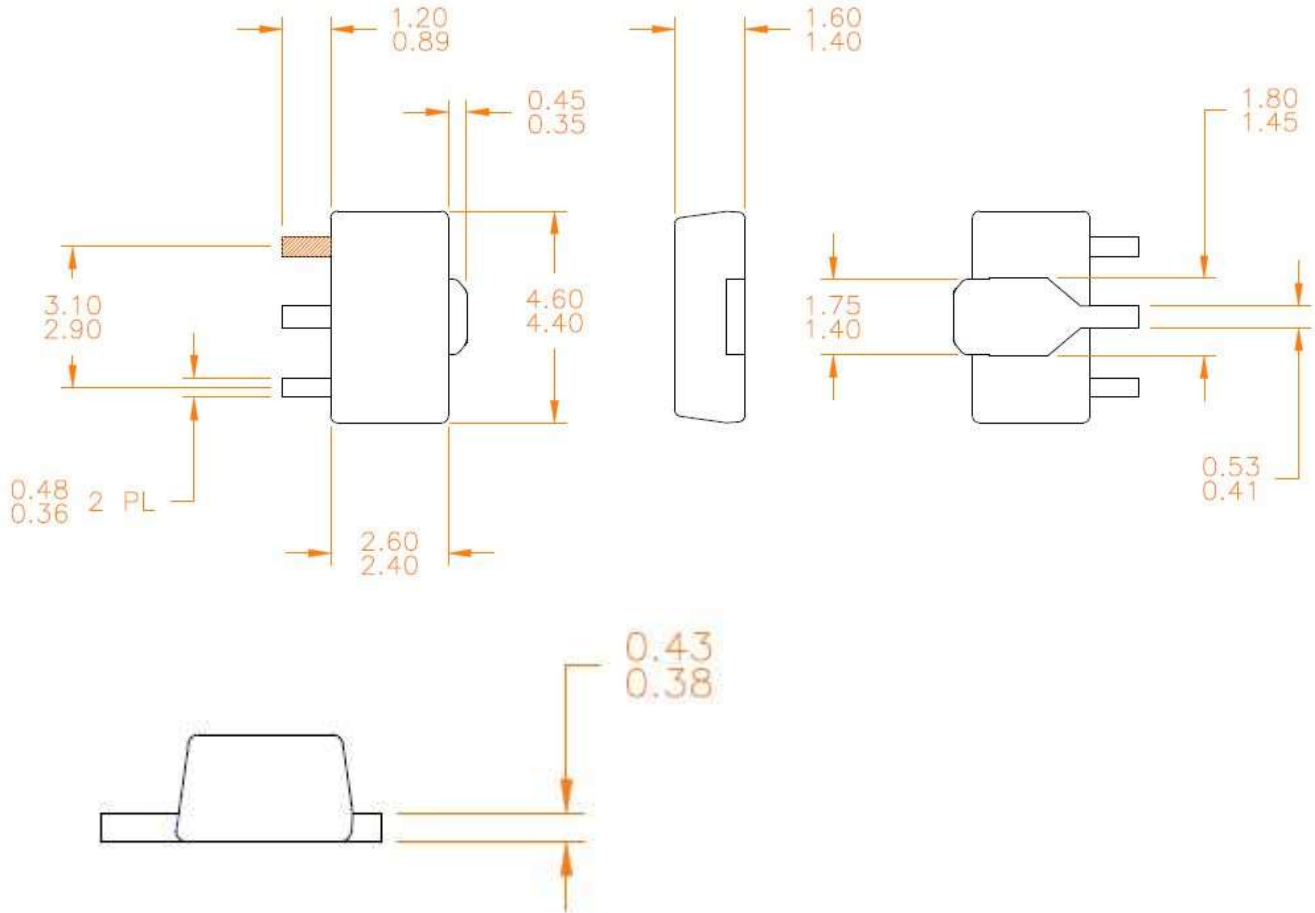

Notes:

1. Dimensions in millimeters

Package Marking

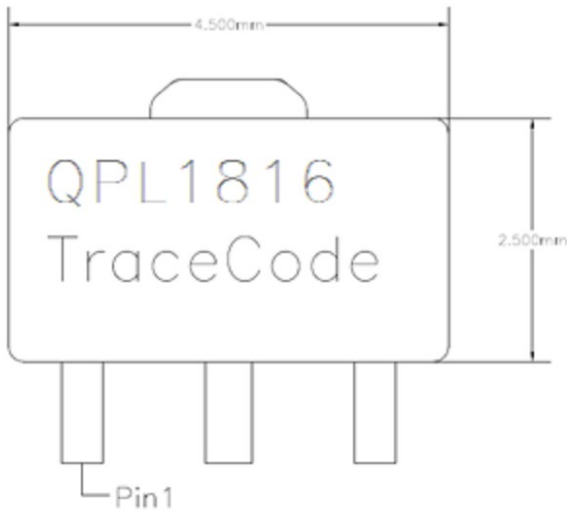

Recommended Mounting Pattern

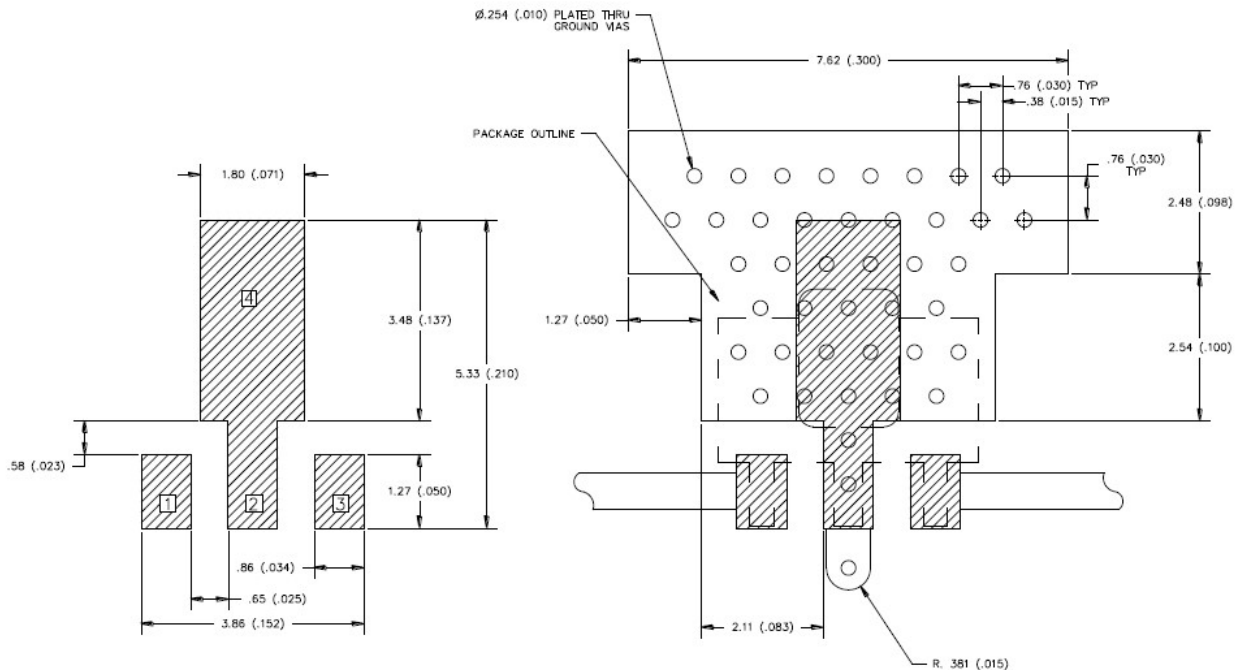

Notes:

1. Ground/thermal vias are critical for the proper performance of this device. Vias should use a .35 mm (#80/.0135") diameter drill and have a final, plated thru diameter of 0.25 mm (0.010").
2. Add as much copper as possible to inner and outer layers near the part to ensure optimal thermal performance.
3. RF trace width depends upon the PC board material and construction.
4. All dimensions are in millimeters (inches). Angles are in degrees.