

Product Overview

The QPL1819 is a GaAs pHEMT single ended MMIC RF amplifier IC featuring 20dB of gain and low noise. This high linearity IC is designed to support DOCSIS 4.0 Amplifiers and Nodes, as well as Fiber to The Home (FTTH), Satellite, Terrestrial TV, Home Gateways, and Cable Modems applications from 50 to 1800MHz. The QPL1819 is powered by a single 5V supply and packaged in a 3 x 3 16-pin QFN.

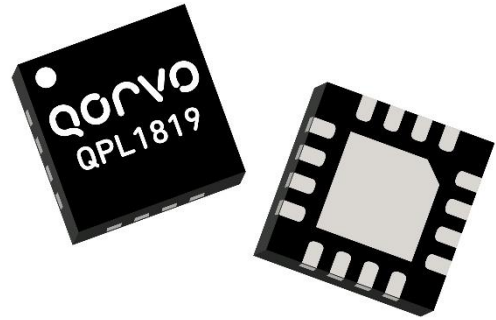

Functional Block Diagram

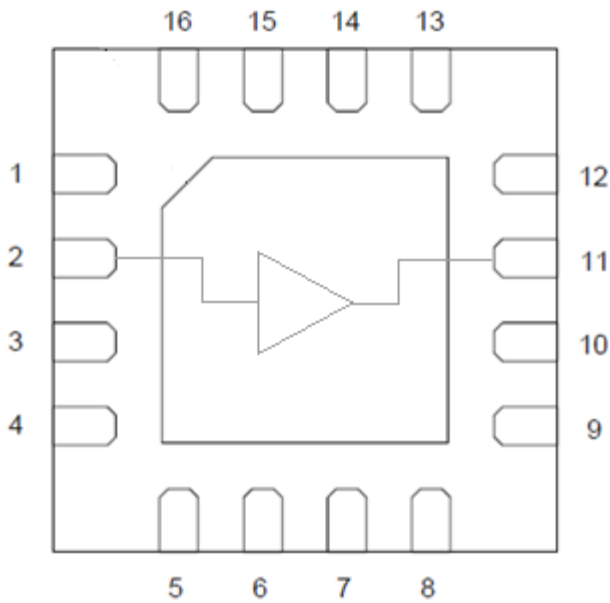

3 x 3 16-pin QFN Package

Key Features

- 50 MHz to 1800 MHz Operation
- 5 V Operation
- Gain: 20 dB Typical
- Noise Figure: 1.7 dB
- Adjustable Bias Using External Resistors
- RoHS Compliant

Applications

- DOCSIS 4.0 Amplifiers
- DOCSIS 4.0 Optical Nodes
- DOCSIS 4.0 Remote PHY Devices
- FTTH GPON and GEPON
- DOCSIS 4.0 Cable Modem and Home Gateways
- Single Ended Gain Block

Ordering Information

Part Number	Description
QPL1819EVB-01	Evaluation Board
QPL1819SB	Sample bag with 5 pieces
QPL1819SR	7" Reel with 100 pieces
QPL1819TR7	7" Reel with 2500 pieces

Absolute Maximum Ratings

Parameter	Rating
Supply Voltage (VCC)	+10 V
Supply Current (I _{DD})	170 mA
Maximum RF Input Level	+60 dBmV
Operating Temperature Range	-40 to +100 °C
Storage Temperature Range	-65 to +150 °C
Maximum Junction Temperature	+150 °C

Exceeding any one or a combination of the Absolute Maximum Rating conditions may cause permanent damage to the device. Extended application of Absolute Maximum Rating conditions to the device may reduce device reliability.

Electrical Specifications at +5 V

Parameter	Condition ⁽¹⁾	Min	Typ	Max	Unit
Supply Voltage (VCC)			5		V
Supply Current (I _{DD})			120		mA
Frequency Range		50		1800	MHz
Gain			20		dB
Gain Slope			0.3		dB
Reverse Isolation			23		dB
Input Return Loss			20		dB
Output Return Loss			20		dB
MER	At +58dBmV Total Composite Output power. 108MHz to 1791MHz, 280Ch, SC-QAM, 0dB tilt, 0dB offset		45		dB
Noise Figure			1.7		dB
OIP2L	+5 dBm / tone output @ 1800MHz		67		dBm
OIP2U	+5 dBm / tone output @ 1800MHz		57		dBm
OIP3	+5 dBm / tone output @ 1800MHz		34		dBm
OP1dB			19		dBm
Thermal Resistance	Θ _{JC}		57		°C/W

Note: Typical performance at these conditions: Temp = +25 °C, VCC = +5 V, 75 Ω system, Full band unless otherwise noted

Evaluation Board Schematic 50 MHz – 1800 MHz

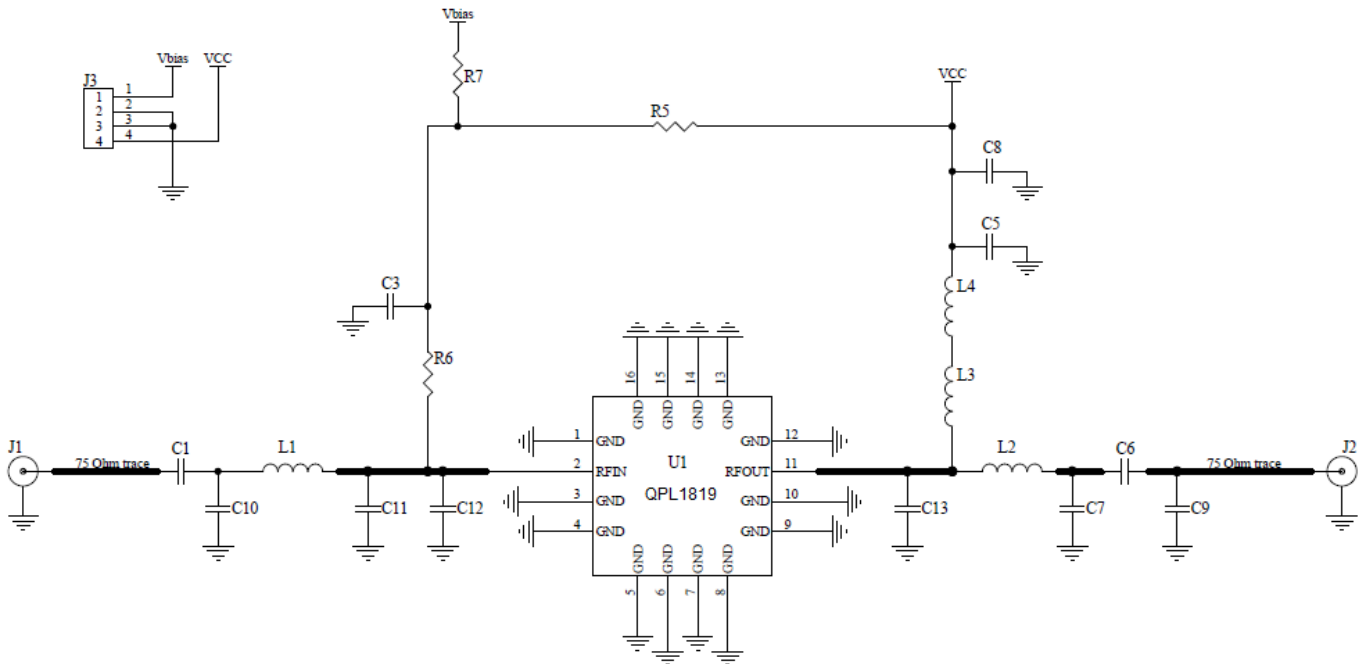

Evaluation Board Bill of Materials

Ref Des	Description	Manufacturer	Part Number
U1	1791MHz, Low Noise, High Linearity Amp	Qorvo	QPL1819
PCB	EVB PCB, QPL1818	Qorvo	SAP 296405
C1, C6	CAP, 270 pF, 5%, 0402	Murata	GCM1555C1H271JA16D
C8	CAP, 0.01uF, 10%, 0402	Murata	GCM155R71H103KA55D
L4	RES, 0 Ω, 0603	VISHAY AMERICAS INC	MCT06030Z0000ZP500
L1, L2	IND, 4.4nH, ±0.1nH, W/W, HI-Q, 0402	Murata	LQW15AN4N4G80
C9	CAP, 0.5pF, +/-0.25pF, 50V, HI-Q	Murata	GJM1555C1HR50CB01D
L3	IND, 2200nH, +/-20%, 500mA, 400MHz, 0603	Taiyo Yuden	BRL1608T2R2M
J1, J2	CONN, F FEM, 75 OHMS	Millimeter Wave	MW-846-C-DD-75
J3	CONN, HDR, ST, 4-PIN, 0.100"	Samtec	TSW-104-08-S-S
R5, R6, R7, C3, C5, C7, C10, C11, C12, C13	DNI		

Evaluation Board Assembly Drawing

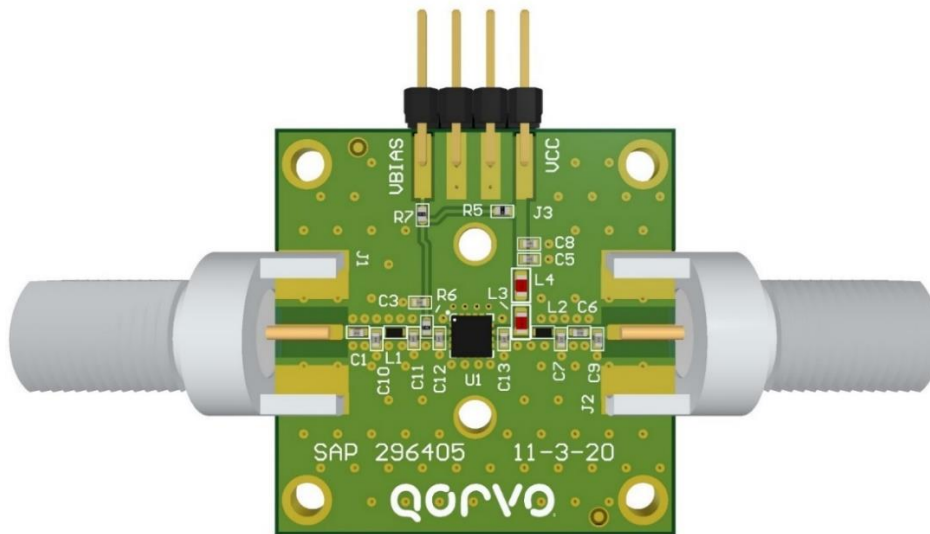
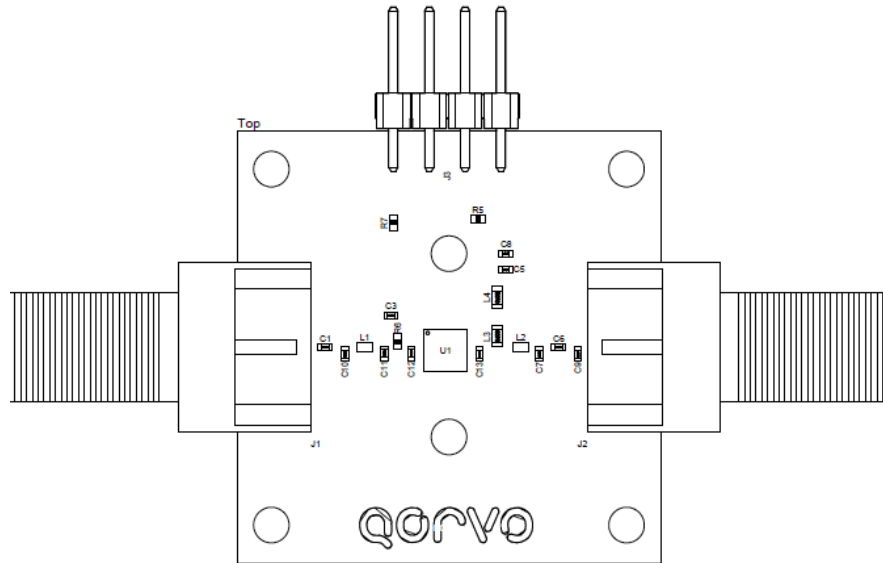

QPL1819 Evaluation Board

LAYER STACK LEGEND

Material	Layer	Thickness	Dielectric Material
	Top Overlay		
Surface Material	Top Solder	0.0010in	SM-001
CF-004	Top Layer	0.0007in	
Core		0.0580in	FR-4
CF-004	Bottom Layer	0.0007in	
Total thickness: 0.0604			

Performance Data at +5V

Test conditions unless otherwise noted: $V_{cc} = +5V$, $Temp = +25C$, $Z_o = 75\Omega$

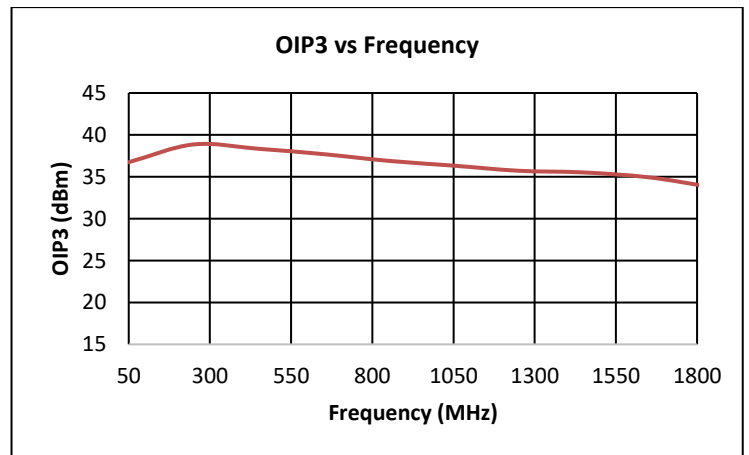
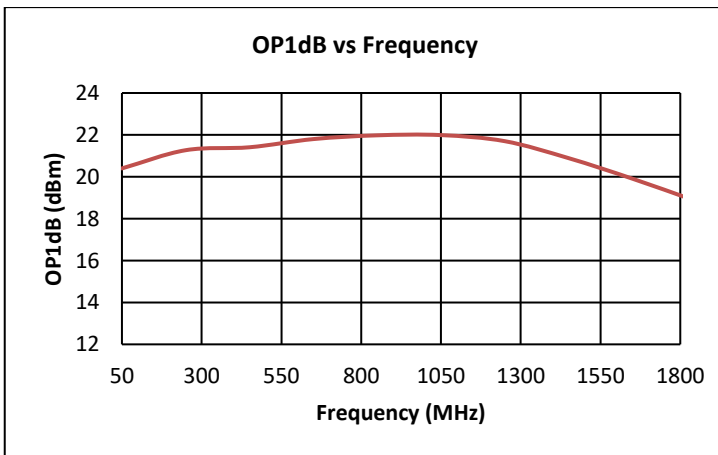
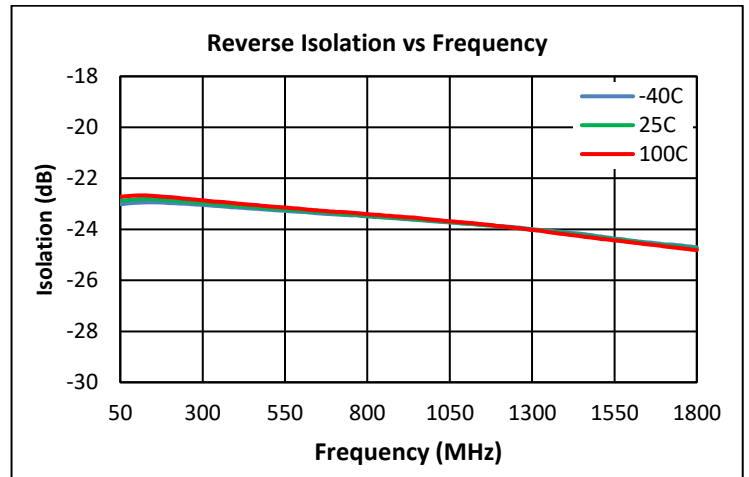
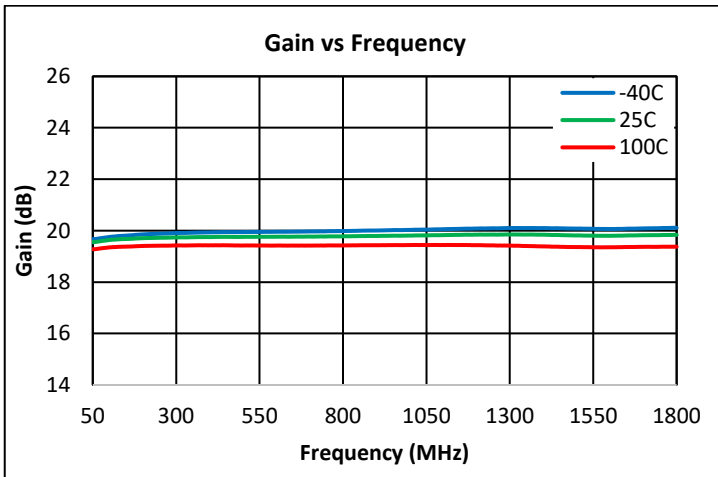
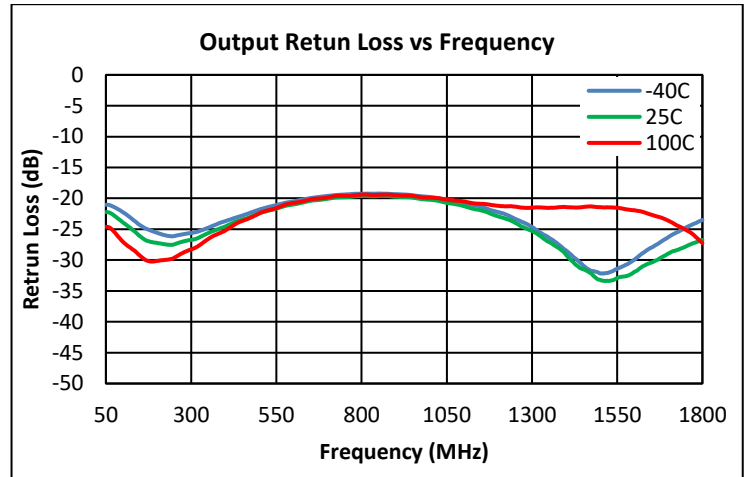
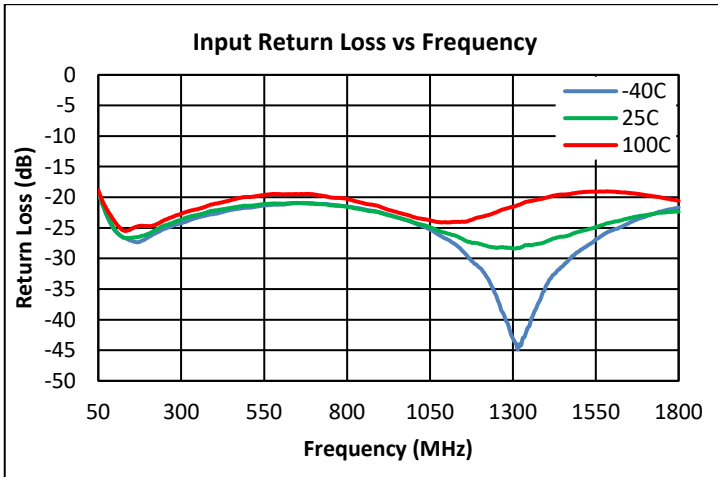

Notes: (1) OIP3: +5 dBm/Tone output

Performance Data at +5V (cont'd)

Test conditions unless otherwise noted: $V_{cc} = +5V$, $Temp = +25C$, $Z_o = 75\Omega$

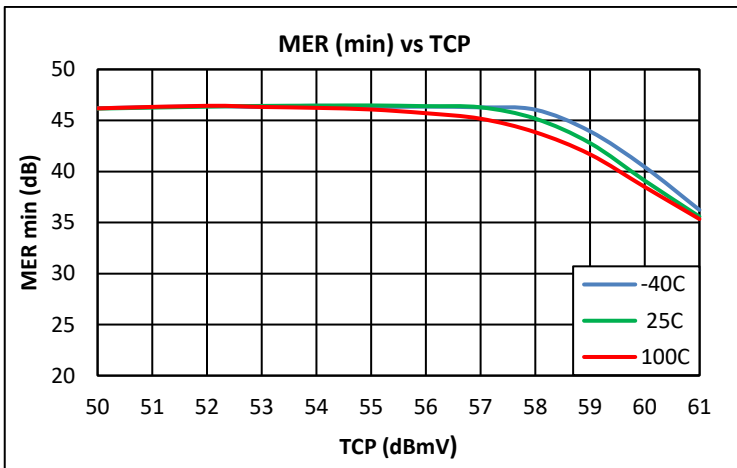
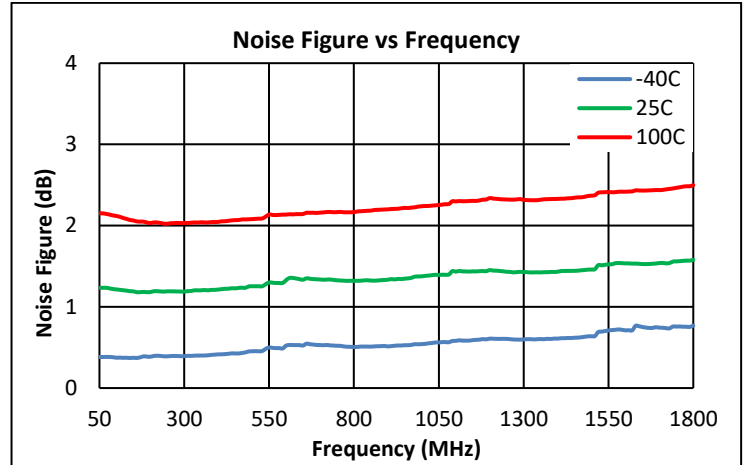
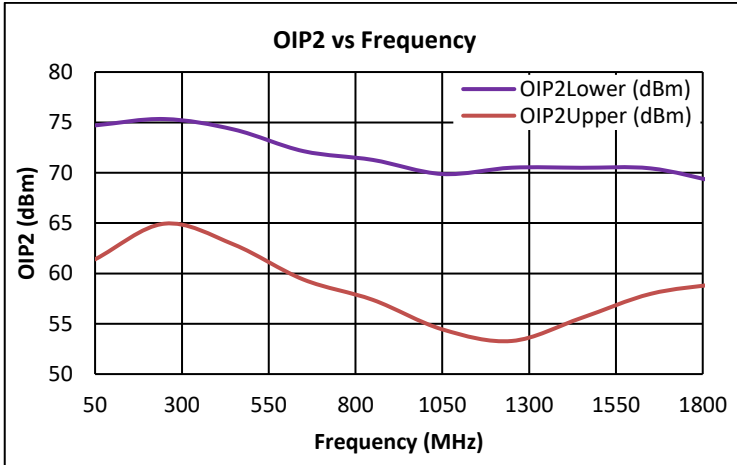

Notes: (1) OIP2: +5 dBm / tone output
 (2) MER is uncorrected. Test Conditions: (108 – 1791 MHz, 280 Ch SC-QAM, 0dB Tilt, 0dB offset)

Adjusting Device Current with R_{bias}

For normal operation Resistors R5, R6, and R7 are not populated. To adjust the device current, populate R5 with a zero Ohm Resistor and vary the value of R6 (R_{bias}). The resulting I_{dd} with variation of R_{bias} is shown the graph below.

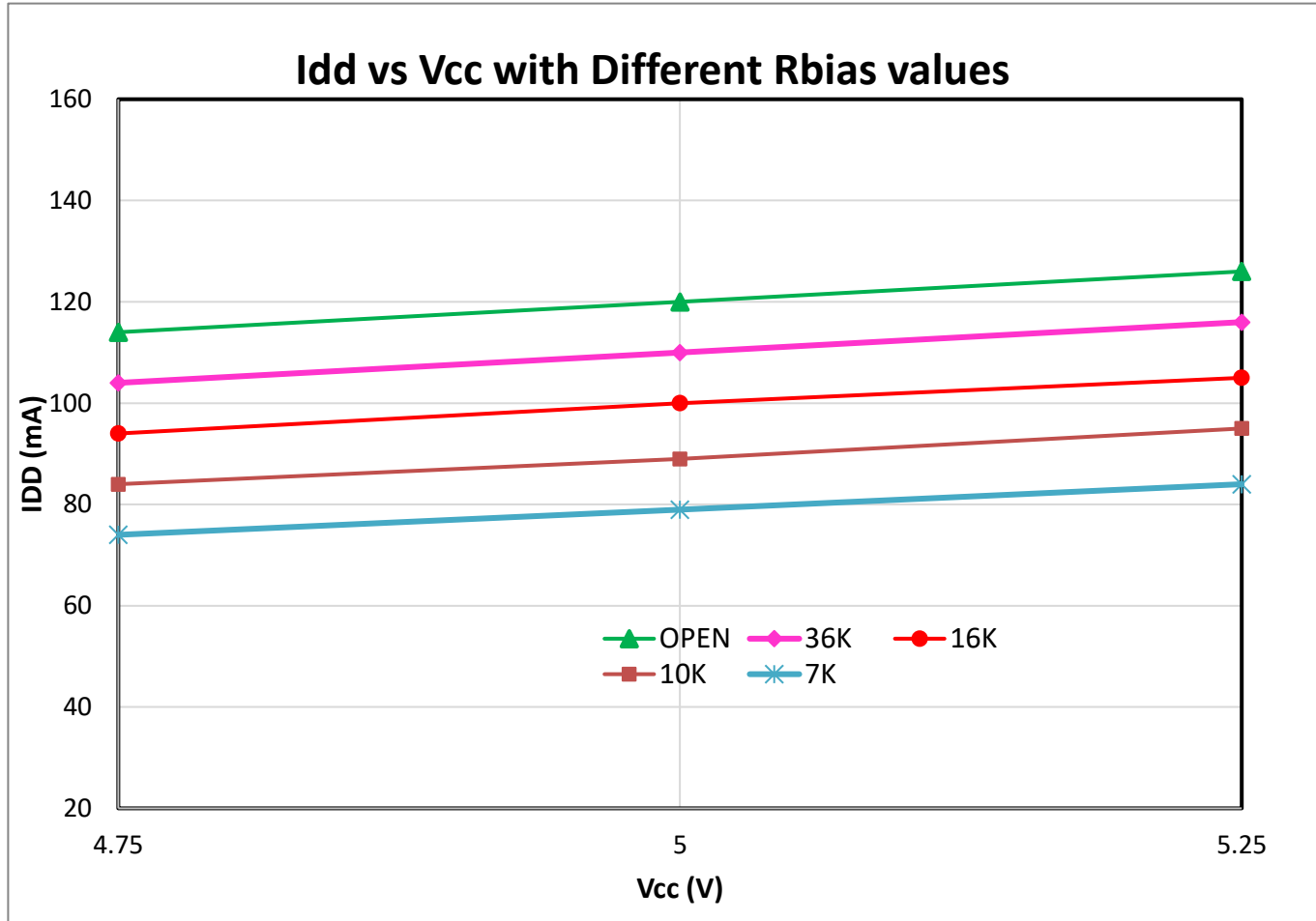

Pin Configuration and Description

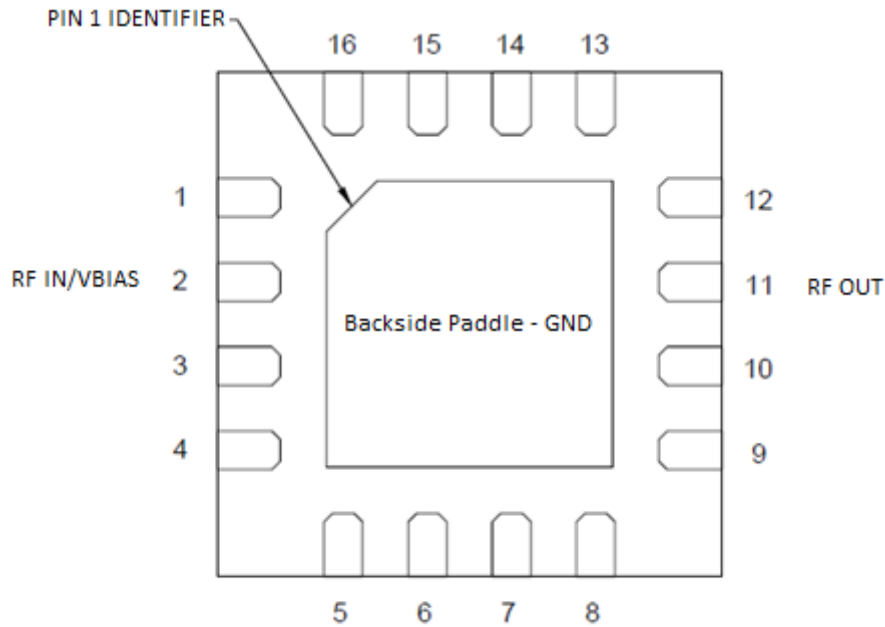

3 x 3 16-Pin QFN

Pin Number	Label	Description
1,3,4,5,6,7,8,9,10,12,13,14,15,16	GND	Internally not connected
2	RF IN / VBIAS	RF Input, DC blocking capacitor required
11	RF OUT	RF Output, DC blocking cap required, RF choke required from DC supply
Backside Paddle	GND	RF/DC/Thermal/Ground. Minimize the inductance and thermal resistance.

Package Outline

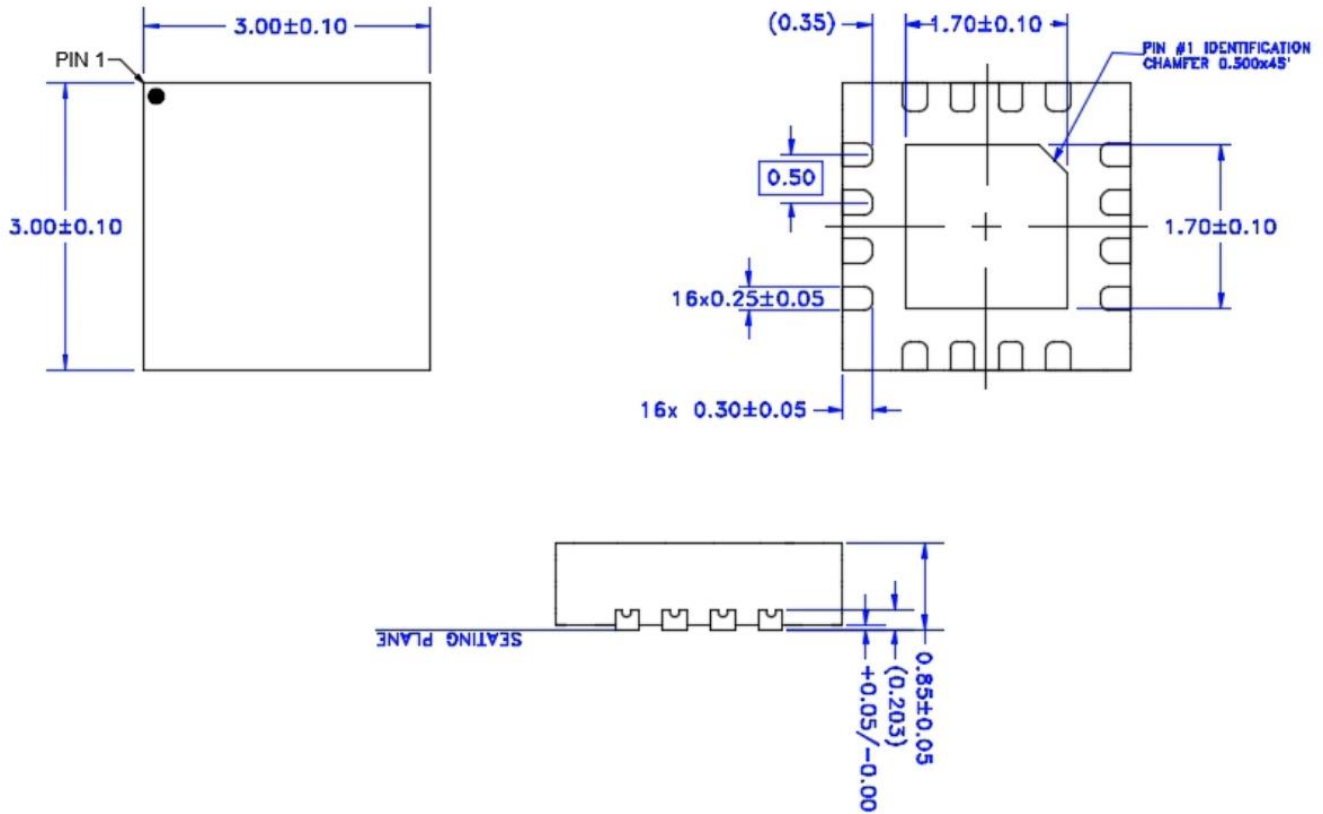

3 x 3 16-pin QFN

Notes:

1. Dimensions in millimeters

Handling Precautions

Parameter	Rating	Standard
ESD – Human Body Model (HBM)	500V, 1B	ANSI / ESDA / JEDEC JS-001
ESD – Charged Device Model (CDM)	2000V, C3	ANSI / ESDA / JEDEC JS-002
MSL – Moisture Sensitivity Level	MSL 1	IPC / JEDEC J-STD-020



Caution!
ESD-Sensitive Device

Solderability

Compatible with both lead-free (260 °C max. reflow temp.) and tin/lead (245 °C max. reflow temp.) soldering processes. Solder profiles available upon request.

Contact plating: NiPdAu

RoHS Compliance

This part is compliant with 2011/65/EU RoHS directive (Restrictions on the Use of Certain Hazardous Substances in Electrical and Electronic Equipment) as amended by Directive 2015/863/EU.

This product also has the following attributes:

- Lead Free
- PFOS Free
- Halogen Free (Chlorine, Bromine)
- Antimony Free
- TBBP-A (C₁₅H₁₂Br₄O₂) Free
- SVHC Free



Contact Information

For the latest specifications, additional product information, worldwide sales and distribution locations:

Tel: 1-844-890-8163

Web: www.qorvo.com

Email: customer.support@qorvo.com