

Product Overview

The QPL1820 is an ultra-linear, GaAs pHEMT, differential RF amplifier. The device features a cascode design which provides 22dB of flat gain along with very low distortion from 50MHz to 1.8GHz. This ultra-linear IC is designed to support Broadband CATV DOCSIS 4.0 applications, such as Nodes, Amplifiers, and Remote PHY Devices, as well as Fiber to The Home (FTTH), Home Gateways, and Cable Modems. The device is powered by a single supply that can operate from 5V to 8V and current can be set from 260 mA to 350 mA. At 5V and 260 mA the QPL1820 provides an output of 63dBmV TCP with a MER of 45dB. When driven with 8V and 350mA the output is 67 dBmV TCP with a MER of 45dB. The QPL1820 is packaged in a 12-pin 5x5 mm² Laminate Module.

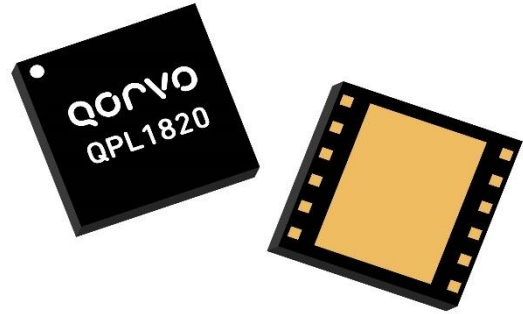

Functional Block Diagram

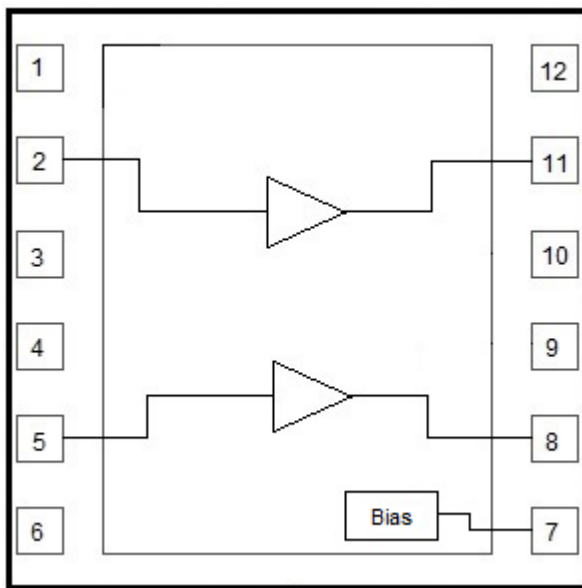

5 x 5 12-pin Laminate MCM Package

Key Features

- 50 MHz to 1800 MHz Operation
- 5 V to 8V Operation
- Gain: 22 dB Typical
- TCP: 63dBmV @ 5V
- TCP: 67dBmV @ 8V
- Noise Figure: 1.6/3.5dB @ 50/1800MHz
- Adjustable Bias Using External Resistors
- RoHS Compliant

Applications

- DOCSIS 4.0 Amplifiers
- DOCSIS 4.0 Optical Nodes
- DOCSIS 4.0 Remote PHY Devices
- FTTH GPON and GEAPON
- DOCSIS 4.0 Cable Modem and Home Gateways

Ordering Information

Part Number	Description
QPL1820EVB-01	Evaluation Board
QPL1820SB	Sample bag with 5 pieces
QPL1820SR	7" Reel with 100 pieces
QPL1820TR13	13" Reel with 2500 pieces

Absolute Maximum Ratings

Parameter	Rating
Supply Voltage (V_{DD})	+10 V
Supply Current (I_{DD})	400 mA
Maximum Input Level	+65 dBmV
Operating Temperature Range	-40 to +100 °C
Storage Temperature Range	-65 to +150 °C
Maximum Junction Temperature	+150 °C

Exceeding any one or a combination of the Absolute Maximum Rating conditions may cause permanent damage to the device. Extended application of Absolute Maximum Rating conditions to the device may reduce device reliability.

Electrical Specifications

Parameter	Condition ⁽¹⁾	Min	Typ	Max	Unit
Supply Voltage (V_{DD})			5/8		V
Supply Current (I_{DD})			260/350		mA
Frequency Range		50		1800	MHz
Gain			22		dB
Gain Slope			2		dB
Reverse Isolation			19		dB
Input & Output Return Loss	50 – 1200MHz		20		dB
Input & Output Return Loss	1200 – 1800MHz		18		dB
MER	At +63dBmV @ 5V and +67dBmV @ 8V Total Composite Output power. 108MHz to 1791MHz, 280 Ch, SC-QAM, 10dB tilt, 0dB Offset		45		dB
Noise Figure	50/1800MHz	1.6		3.5	dB
OIP2L	+12 dBm / tone output, $\Delta f=53$ MHz, Full Band		89		dBm
OIP2U	+12 dBm / tone output, $\Delta f=53$ MHz, Full Band		75		dBm
OIP3	+12 dBm / tone output, $\Delta f=6$ MHz, Full Band		45		dBm
OP1dB			26		dBm
Thermal Resistance	Θ_{JC}		12		°C/W

Note: Typical performance at these conditions: Temp = +25 °C, V_{DD} = +5 V, 75 Ω system, Full band unless otherwise noted

Typical Application Schematic 50 MHz – 1800 MHz

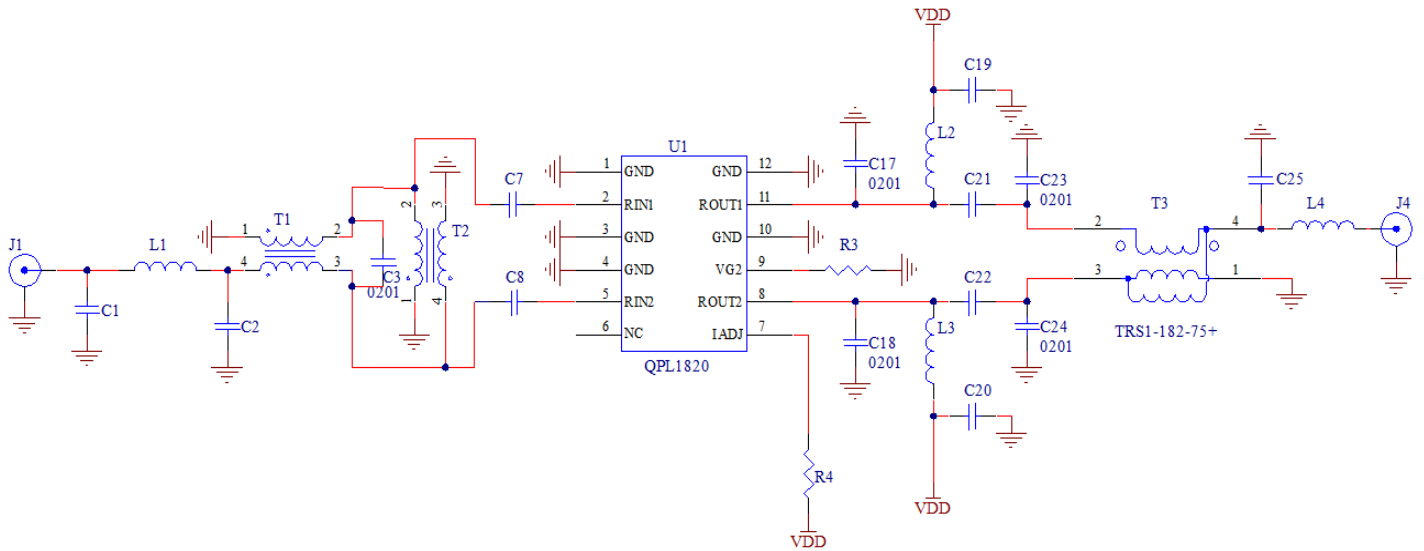

Evaluation Board Schematic 50 MHz – 1800 MHz

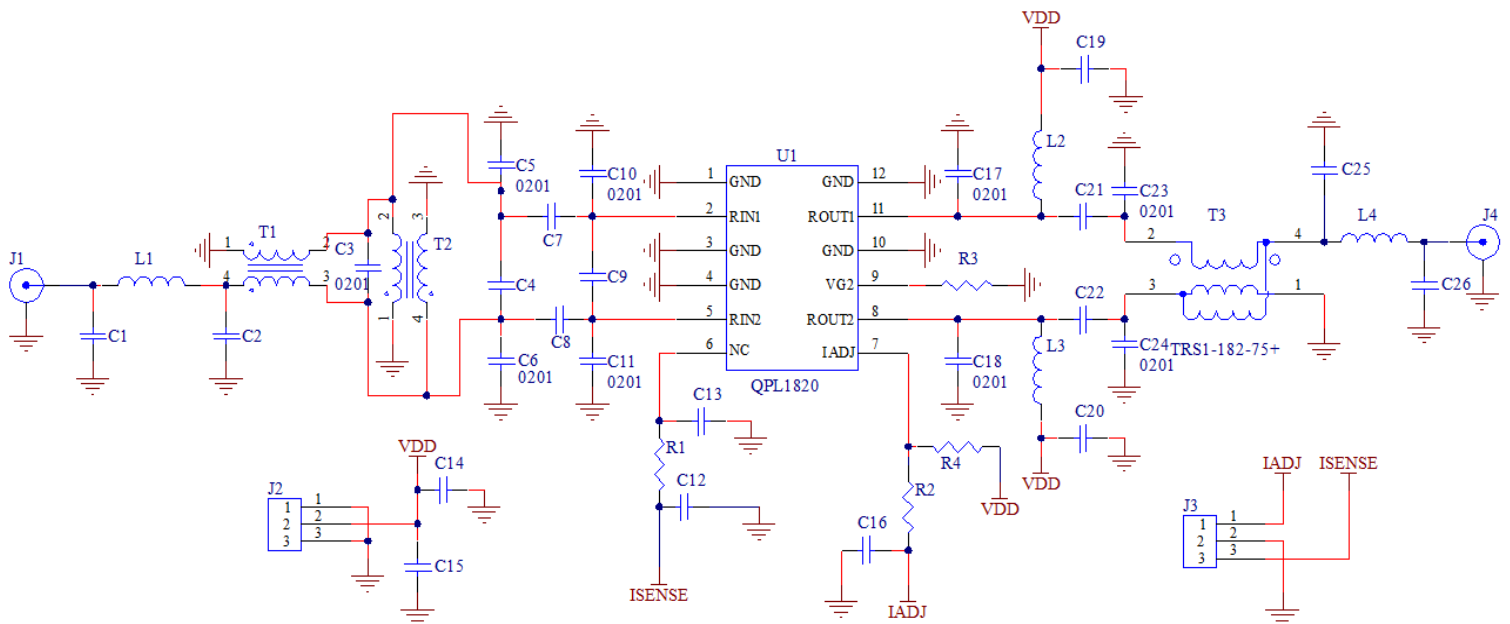

Evaluation Board Bill of Materials: 5V

Ref Des	Description	Manufacturer	Part Number
U1	1800MHz, Ultra-Linear Amp	Qorvo	QPL1820
PCB	EVB PCB, QPL182x-4000	Qorvo	SAP 300366
C1, C25	CAP, 0.2pF, +/-0.1pF, 50V, Hi-Q, 0402	Kamaya	RF03N1R3B250CT
C2	CAP, 0.4pF, +/-0.1pF, 50V, Hi-Q, 0402	Murata	GJM1555C1HR40BB01D
C3	CAP, 0.7pF, +/-0.1pF, 25V, C0G, 0201	Murata	GRM0335C1ER70BA01D
C7, C8	CAP, 680pF, 10%, 100V, X7R, 0402	Taiyo Yuden	RM HMK105B7681KV-F
C14, C15, C19, C20	CAP, 0.01uF, 10%, 50V, X7R, 0402	Murata	GCM155R71H103KA55D
C17, C18	CAP, 1.3pF, +/-0.1pF, 25V, HI-Q, 0201	Kamaya	RF03N1R3B250CT
C21, C22	Cap, 470pF/10% / 0402/X7R/50V/NISN	Murata	GCM155R71H471KA37D
C23, C24	CAP, 0.3pF, +/-0.1pF, 25V, HI-Q, 0201	Murata	GJM0335C1ER30BB01D
L1	IND, 1.2nH, +/-0.3nH, M/L, 0402	Murata	LQG15HN1N2S02D
L2, L3	IND, 470nH, 5%, 1.4A, W/W, 0603	Coilcraft	0603AF-471XJRW
L4	RES, 0 OHM, 5%, 1/10W, 0402	Kamaya	RMC1/16SJPTH
R3	RES, 3.3K, 5%, 1/16W, 0402	Kamaya	RMC1/16S-332JTH
R4	RES, 1.3K, 1%, 1/10W, 0402	Panasonic	ERJ-2RKF1301X
T1, T2	BALUN, 1GHz ~ 1.5GHz, 0805	Murata	DXW21BN7511SL
T3	1:1 BALUN XFMR, 10 – 1800 MHz	Mini-Circuits	TRS1-182-75+
J1, J4	CONN, F, EDGE MOUNT, 60 MIL	Trompeter Electronics	CBJE130-1
J2, J3	CONN, HDR, ST, 3-PIN, 0.100"	Samtec	TSW-103-07-G-S
R1, R2, C4, C5, C6, C9, C10, C11, C12, C13, C16, C26	DNI		

Evaluation Board Bill of Materials: 8V

Ref Des	Description	Manufacturer	Part Number
U1	1800MHz, Ultra-Linear Amp	Qorvo	QPL1820
PCB	EVB PCB, QPL182x-4000	Qorvo	SAP 300366
C1, C4	CAP, 0.2pF, +/-0.1pF, 50V, Hi-Q, 0402	Kamaya	RF03N1R3B250CT
C2	CAP, 0.4pF, +/-0.1pF, 50V, Hi-Q, 0402	Murata	GJM1555C1HR40BB01D
C3	CAP, 0.6pF, +/-0.1pF, 25V, HI-Q, 0201	Qorvo	CAP1098
C7, C8	CAP, 680pF, 10%, 100V, X7R, 0402	Taiyo Yuden	RM HMK105B7681KV-F
C14, C15, C19, C20	CAP, 0.01uF, 10%, 50V, X7R, 0402	Murata	GCM155R71H103KA55D
C17, C18	CAP, 1.3pF, +/-0.1pF, 25V, HI-Q, 0201	Kamaya	RF03N1R3B250CT
C21, C22	Cap, 470pF/10% / 0402/X7R/50V/NISN	Murata	GCM155R71H471KA37D
L1	IND, 1.2nH, +/-0.3nH, M/L, 0402	Murata	LQG15HN1N2S02D
L2, L3	IND, 470nH, 5%, 1.4A, W/W, 0603	Coilcraft	0603AF-471XJRW
L4	RES, 0 OHM, 5%, 1/10W, 0402	Kamaya	RMC1/16SJPTH
R3	RES, 3.3K, 5%, 1/16W, 0402	Kamaya	RMC1/16S-332JTH
R4	RES, 2K OHM, 1%, 1/10W, 0402	Panasonic	ERJ-2RKF2001X
T1, T2	BALUN, 1GHz ~ 1.5GHz, 75 / 75 OHM, 0805	Murata	DXW21BN7511SL
T3	1:1 BALUN XFMR, 1:1, 10 - 1800 MHz, 75 OHM	Mini-Circuits	TRS1-182-75+
J1, J4	CONN, F, EDGE MOUNT, 60 MIL	Trompeter Electronics	CBJE130-1
J2, J3	CONN, HDR, ST, 3-PIN, 0.100"	Samtec	TSW-103-07-G-S
R1, R2, C5, C6, C9, C10, C11, C12, C13, C16, C23, C24, C25, C26	DNI		

Evaluation Board Assembly Drawing

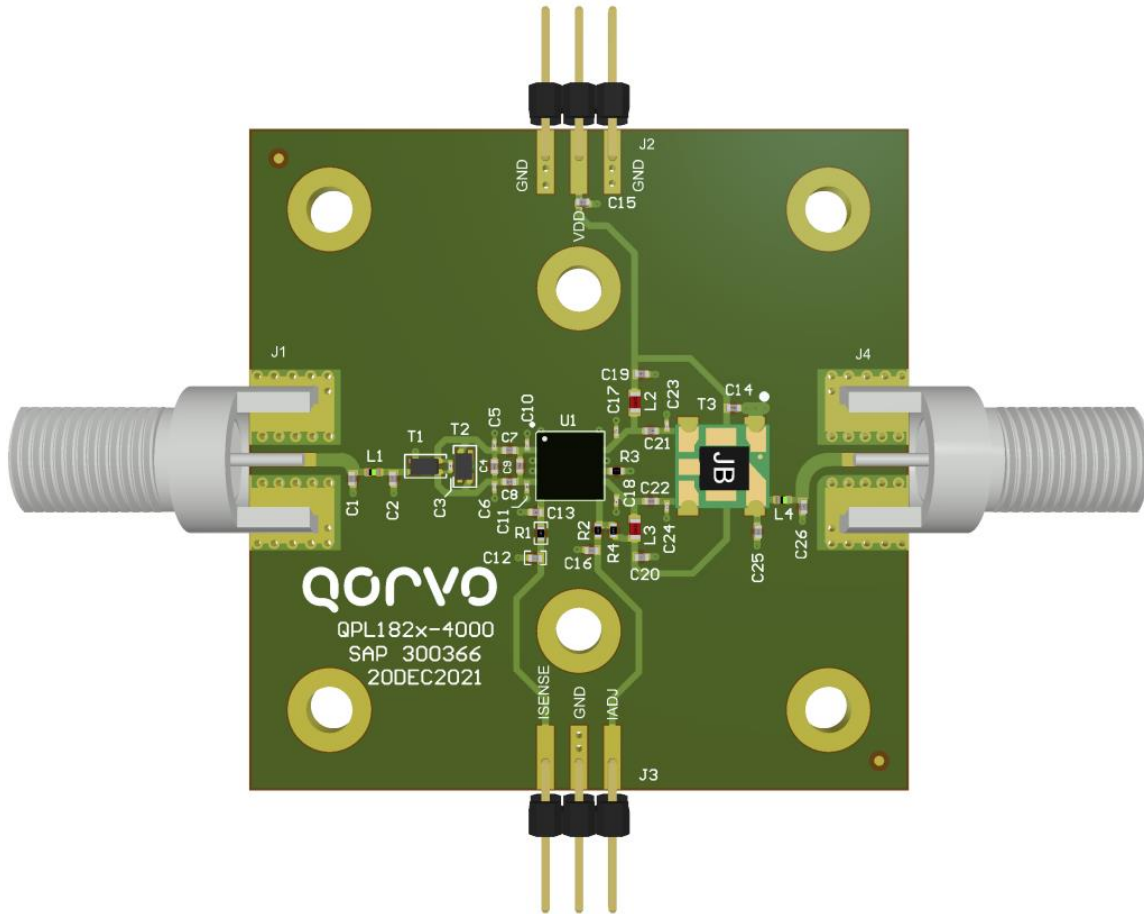

QPL1820 Evaluation Board

Layer Stack Legend

Material	Layer	Thickness	Dielectric Material	Type
	Top Overlay			Legend
	Surface Material	0.0004	SM-001	Solder Mask
	CF-004	0.0007		Signal
	Core	0.0600	RO4003	Dielectric
	CF-004	0.0007		Signal
Total thickness: 0.0618				

Performance Data

Test conditions unless otherwise noted: Vdd = +5V, Temp = +25C, Zo = 75 Ω

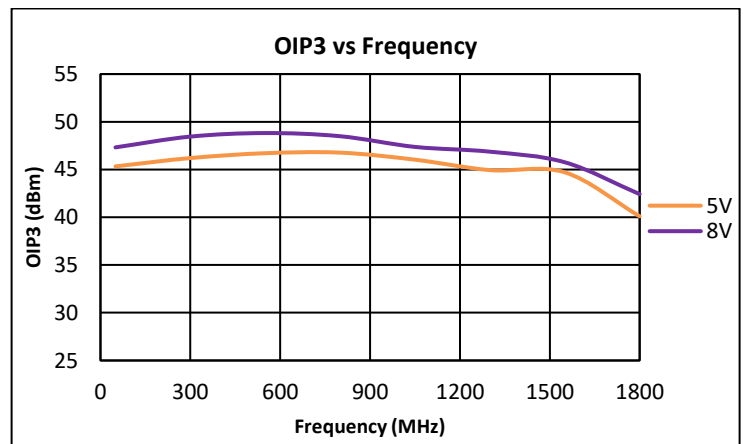
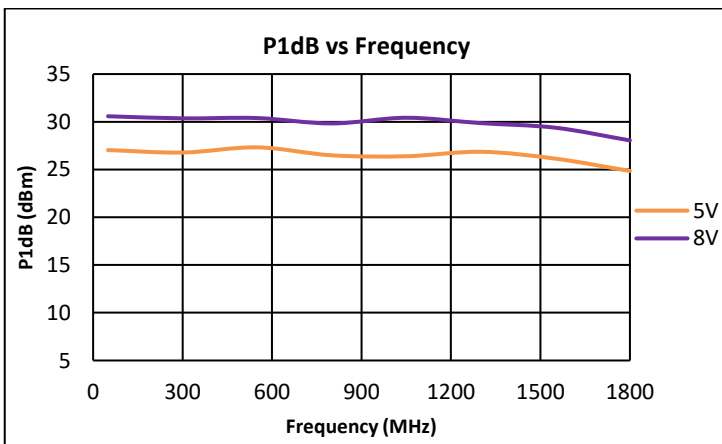
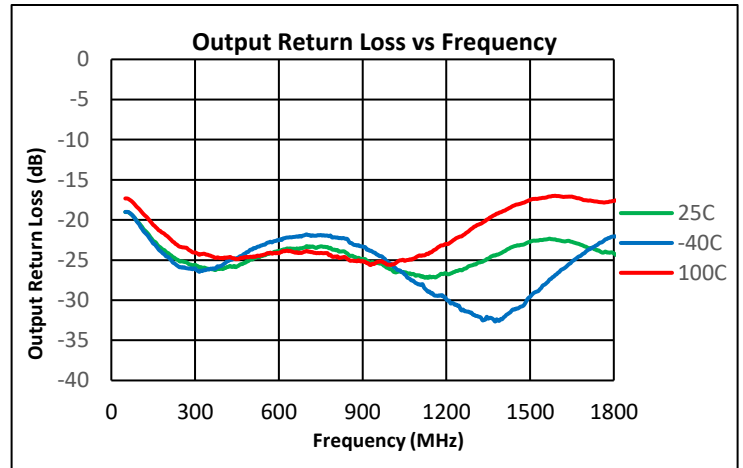
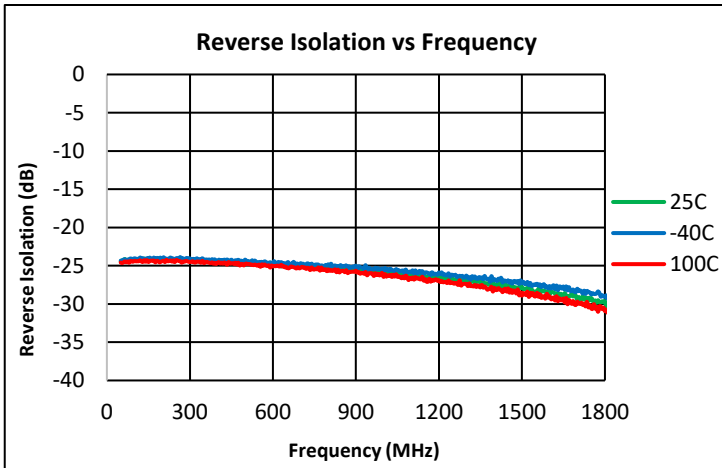
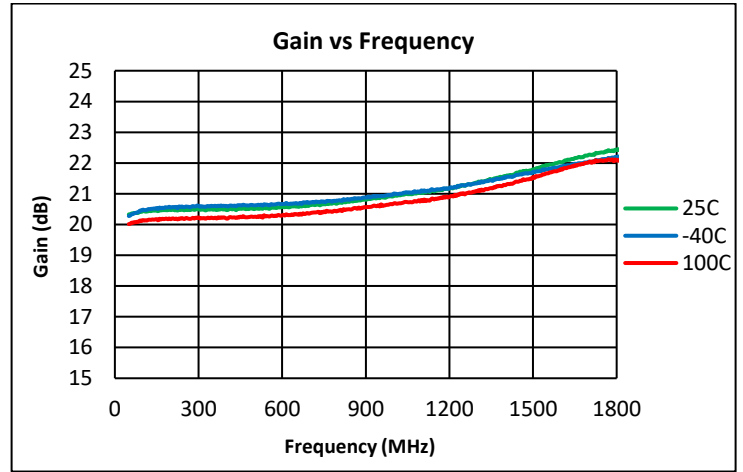
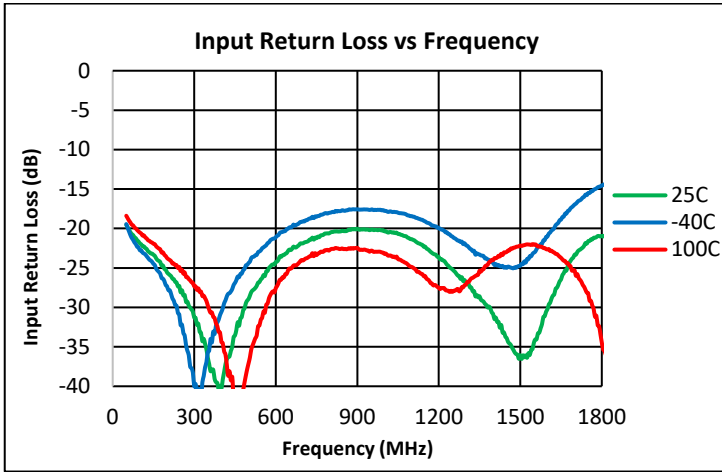

Notes:

- (1) 5V OIP3: +12dBm / tone output
- (2) 8V OIP3: +15dBm / tone output

Performance Data (cont'd)

Test conditions unless otherwise noted: Vdd = +5V, Temp = +25C, Zo = 75Ω

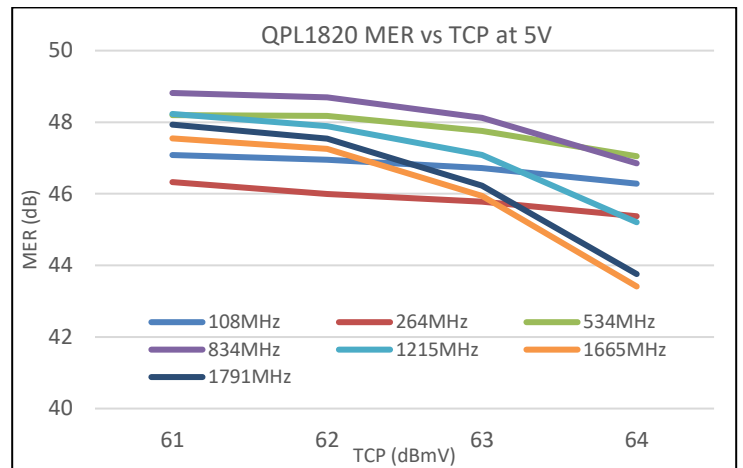
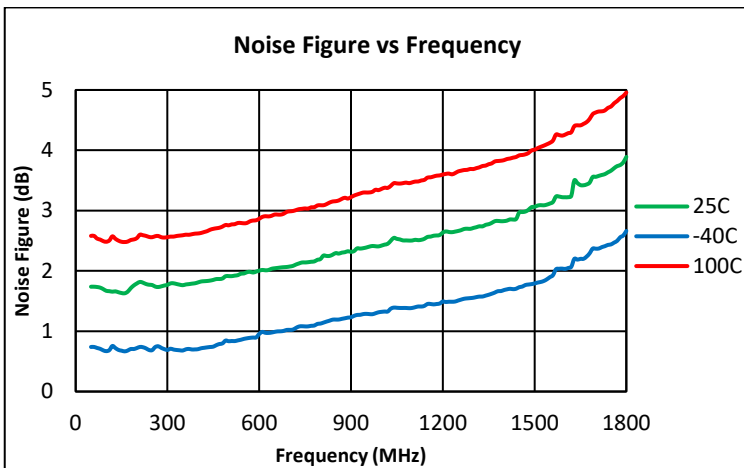
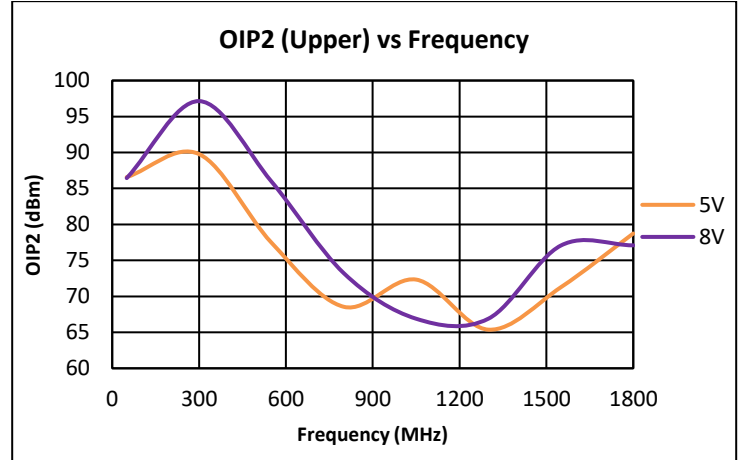
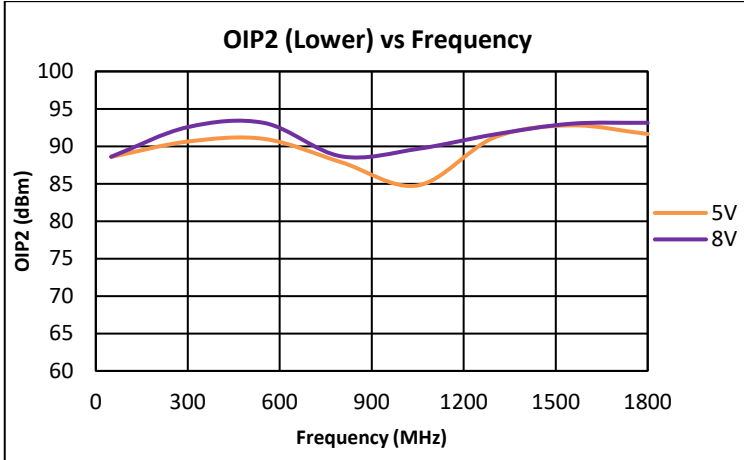

Notes:

- (1) 5V OIP2: +12dBm / tone output
- (2) 8V OIP2: +15dBm/tone output
- (3) MER Test Conditions: (108 – 1791 MHz, 280 Ch SC-QAM, 10dB tilt, 0dB offset)
- (4) MER is uncorrected

Performance Data (cont'd) Vdd = 8V

Test conditions unless otherwise noted: Vdd = +8V, Temp = +25C, Zo = 75Ω

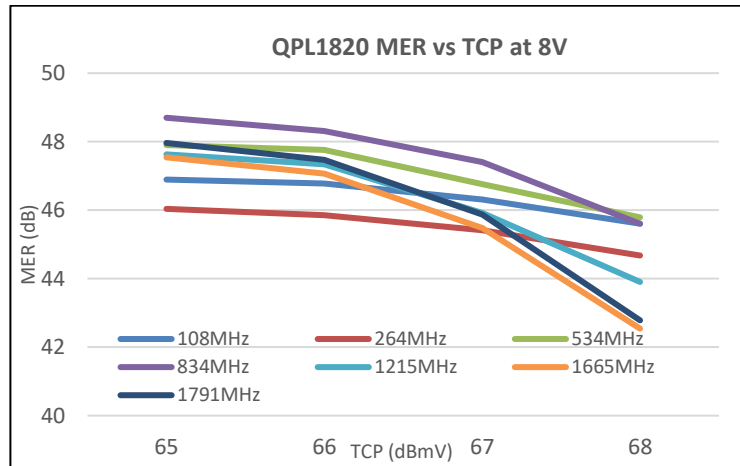
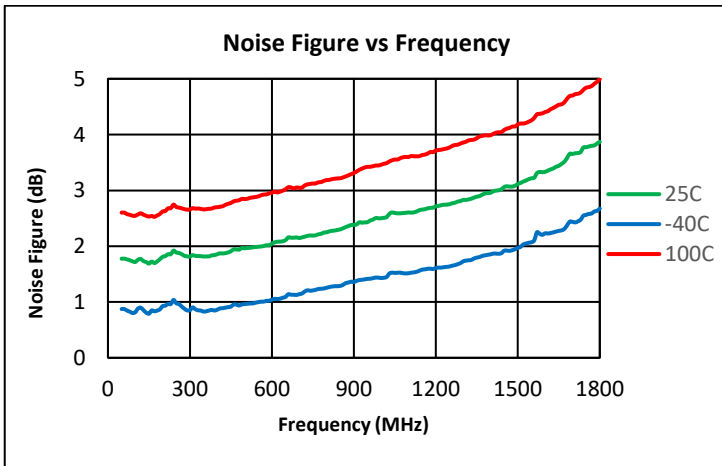
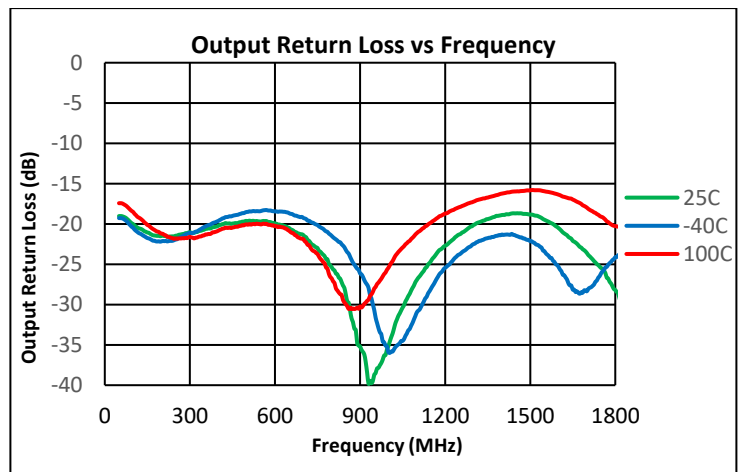
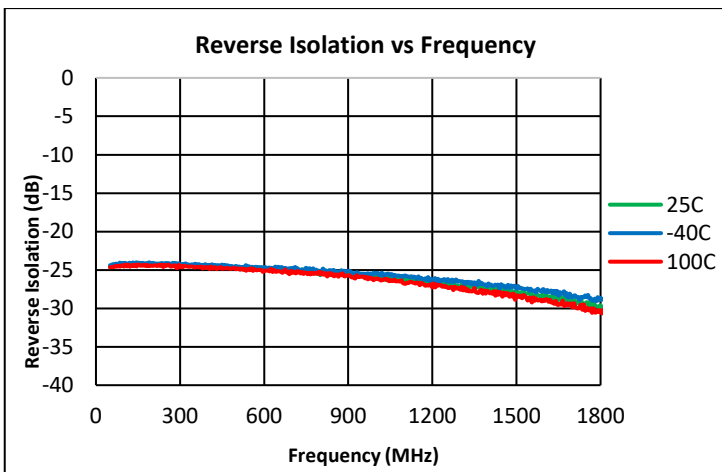
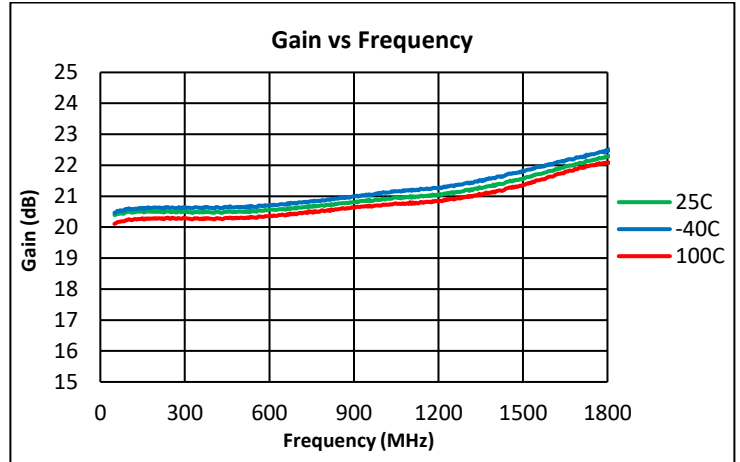
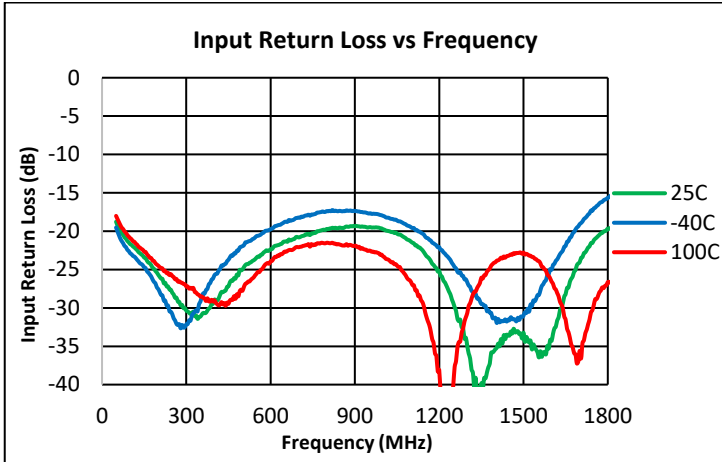

- Notes:
- (1) MER Test Conditions: (108 – 1791 MHz, 280 Ch SC-QAM, 10dB tilt, 0dB offset)
 - (2) MER is uncorrected

IADJ Resistor Value

The Resistor R4 (Rbias) is used to set the device current. In the application circuit, the value of R4 is set to get an IDD of 260mA which is optimal for linearity at 5V. In applications where higher linearity is required, or higher supply rail is present, the IDD can be adjusted by varying the value of R4(See graph below)

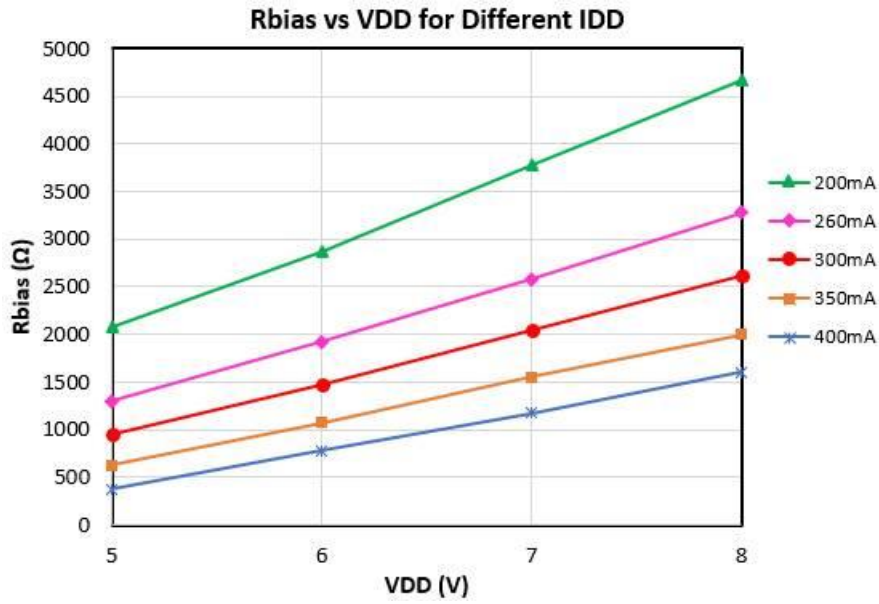

Pin Configuration and Description

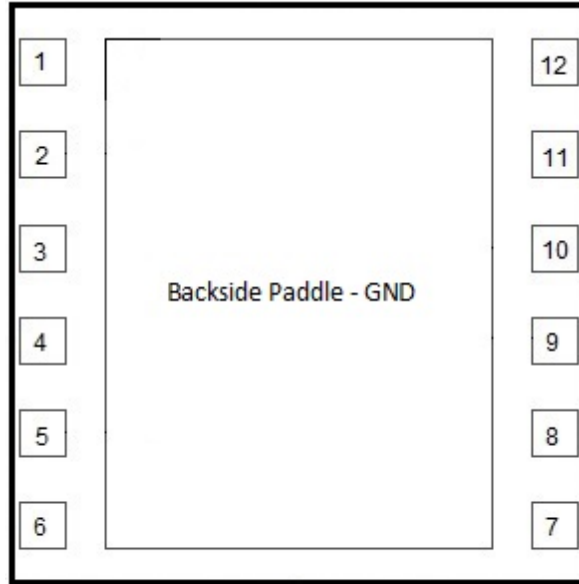

5 x 5 12-pin Laminate MCM Package

Pin Number	Label	Description
1	NC	No internal connection, recommend connecting to EVB GND
2	RFIN+	RF Input +
3	Source1	Must be connected to EVB GND
4	Source2	Must be connected to EVB GND
5	RFIN-	RF input -
6	NC	Recommended to leave open. Do not connect to GND
7	IADJ	IDD current set
8	RFOUT-/VDD2	RF output - and VDD through RF Choke
9	VG2	Cascode device bias resistor divider
10	NC	No internal connection, recommend connecting to EVB GND
11	RFOUT+/VDD	RF output + and VDD through RF Choke
12	NC	No internal connection, recommend connecting to EVB GND
Paddle	GND	DC/RF/Thermal/GND. (Maximize vias in this area)

Package Outline

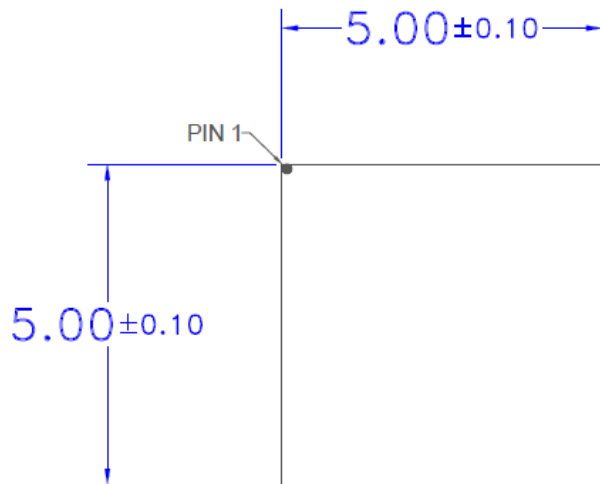

TOP
VIEW

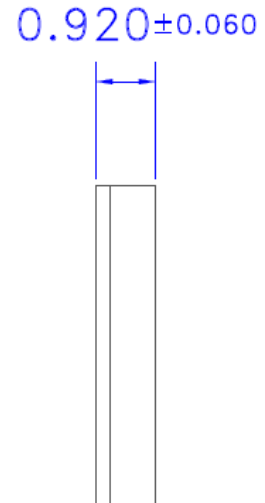

SIDE
VIEW

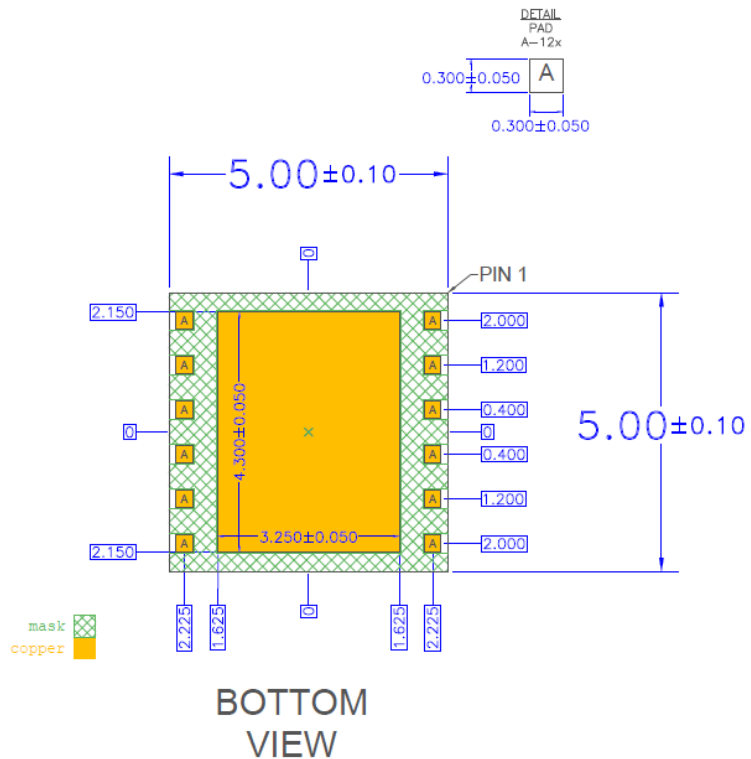

Package Marking

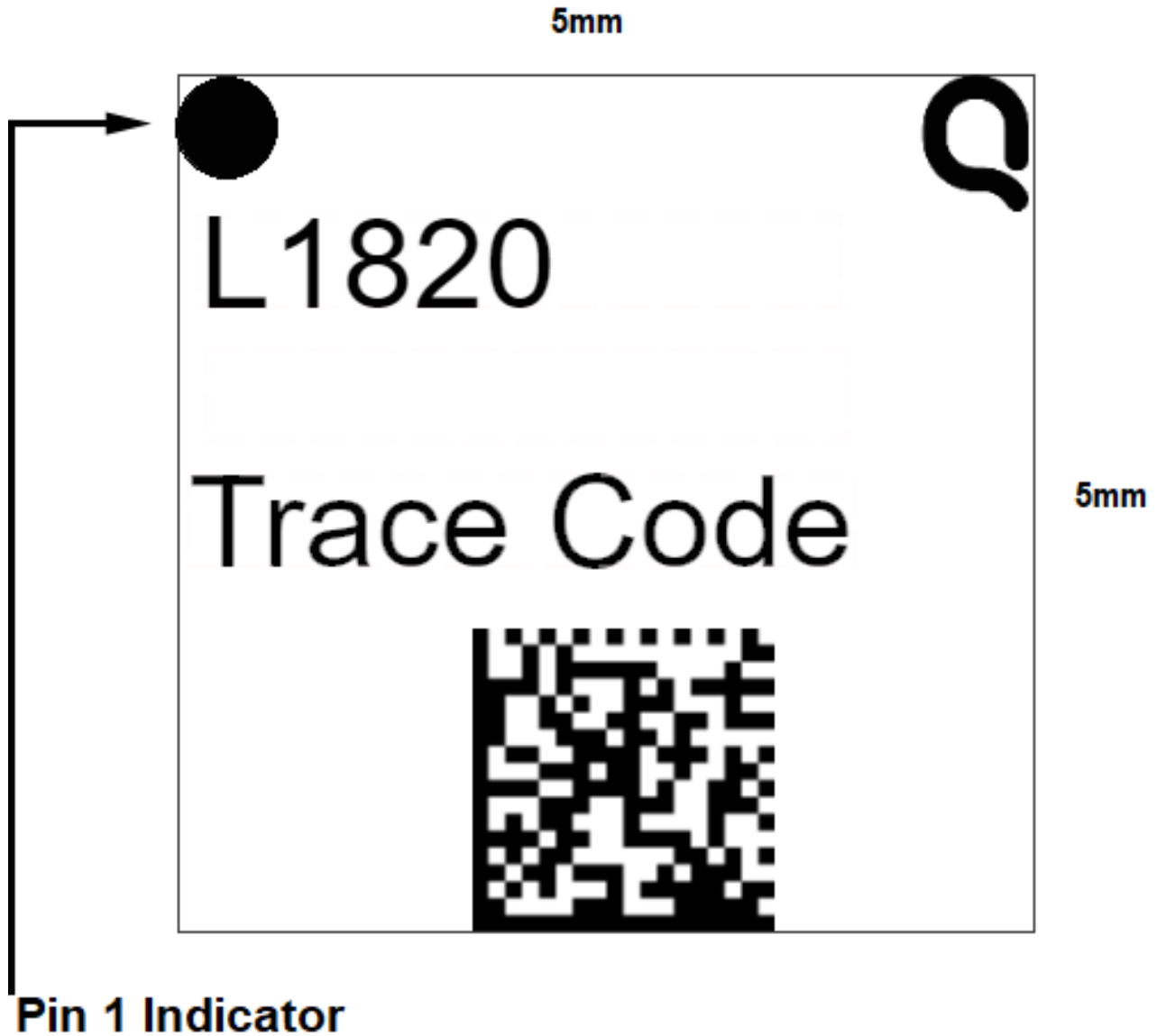

Handling Precautions

Parameter	Rating	Standard
ESD – Human Body Model (HBM)	500V, 1B	ANSI / ESDA / JEDEC JS-001
ESD – Charged Device Model (CDM)	1000V, C3	ANSI / ESDA / JEDEC JS-002
MSL – Moisture Sensitivity Level	MSL 3	IPC / JEDEC J-STD-020



Caution!
 ESD-Sensitive Device

Solderability

Compatible with both lead-free (260 °C max. reflow temp.) and tin / lead (245 °C max. reflow temp.) soldering processes.
 Solder profiles available upon request.

Contact plating: ENEPIG

RoHS Compliance

This part is compliant with 2011/65/EU RoHS directive (Restrictions on the Use of Certain Hazardous Substances in Electrical and Electronic Equipment) as amended by Directive 2015/863/EU.

This product also has the following attributes:

- PFOS Free
- Halogen Free (Chlorine, Bromine)
- Antimony Free
- TBBP-A (C₁₅H₁₂Br₄O₂) Free
- SVHC Free

Contact Information

For the latest specifications, additional product information, worldwide sales and distribution locations:

Tel: 1-844-890-8163

Web: www.qorvo.com

Email: customer.support@qorvo.com