

Product Overview

The QPL1822 is an ultra-linear, GaAs pHEMT, differential RF amplifier. The device features a cascode design which provides 15dB of gain along with very low distortion from 5MHz to 1.8GHz. This ultra-linear IC is designed to support Broadband CATV DOCSIS 4.0 applications, such as Nodes, Amplifiers, and Remote PHY Devices, as well as Fiber to The Home (FTTH), Home Gateways, and Cable Modems. The device is powered by a single supply that can operate from 5V to 8V and current can be set from 260 mA to 350 mA. At 5V and 260 mA the QPL1822 provides an output of 63dBmV TCP with a MER of 45dB. When driven with 8V and 350mA the output is 67 dBmV TCP with a MER of 45dB. The QPL1822 is packaged in a 12-pin 5x5 mm² Laminate Module

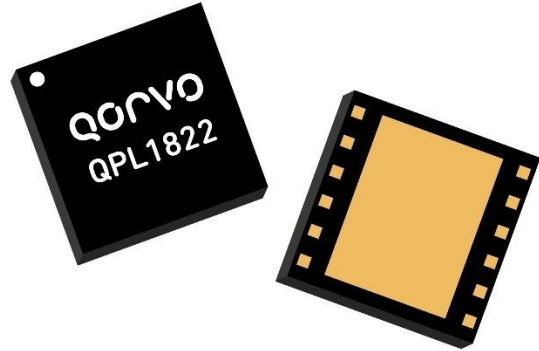

5 x 5 12-pin Laminate MCM Package

Functional Block Diagram

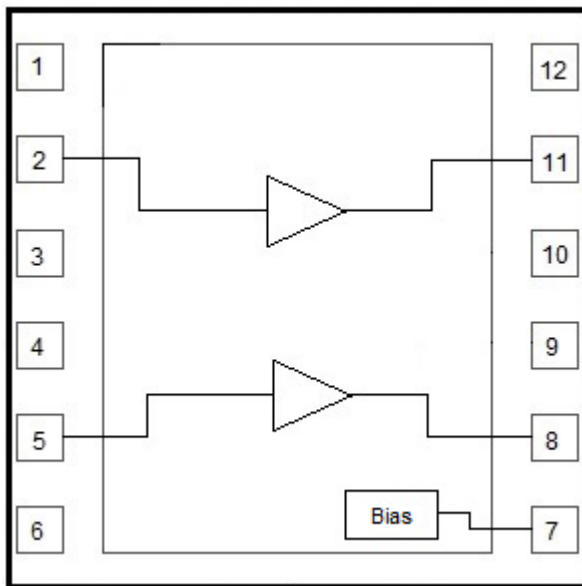

Key Features

- 5 MHz to 1800 MHz Operation
- 5V & 8V Operation
- Gain: 15dB Typical
- TCP: 63dBmV @ 5V
- TCP: 67dBmV @ 8V
- Noise Figure: 2.2/3.6dB @ 50/1800MHz
- Adjustable Bias Using External Resistors
- RoHS Compliant

Applications

- DOCSIS 4.0 Amplifiers
- DOCSIS 4.0 Optical Nodes
- DOCSIS 4.0 Remote PHY Devices
- FTTH GPON and GEPON
- DOCSIS 4.0 Cable Modem and Home Gateways

Ordering Information

Part Number	Description	Part Number	Description
QPL1822EVB-01	5V Downstream Evaluation Board	QPL1822SB	Sample bag with 5 pieces
QPL1822EVB-02	5V Upstream Evaluation Board	QPL1822SR	7" Reel with 100 pieces
QPL1822EVB-03	8V Downstream Evaluation Board	QPL1822TR13	13" Reel with 2500 pieces
QPL1822EVB-04	8V Upstream Evaluation Board		

Absolute Maximum Ratings

Parameter	Rating
Supply Voltage (V_{DD})	+10 V
Supply Current (I_{DD})	400 mA
Maximum Input Level	+65 dBmV
Operating Temperature Range (Operating Device Heat Slug Temperature)	-40 to +100 °C
Storage Temperature Range	-65 to +150 °C
Maximum Junction Temperature	+150 °C

Exceeding any one or a combination of the Absolute Maximum Rating conditions may cause permanent damage to the device. Extended application of Absolute Maximum Rating conditions to the device may reduce device reliability.

Electrical Specifications (Downstream)

Parameter	Test Condition	Min	Typ	Max	Unit
Supply Voltage (V_{DD})			5/8		V
Supply Current (I_{DD})			260/350		mA
Frequency Range		50		1800	MHz
Gain at 50 MHz			15		dB
Gain at 1800 MHz			16		dB
Gain Slope			1		dB
Reverse Isolation			21		dB
Input Return Loss	50 – 1200 MHz		-20		dB
	1200 – 1800 MHz		-20		dB
Output Return Loss	50 – 1200 MHz		-20		dB
	1200 – 1800 MHz		-20		dB
MER	At +63dBmV @ 5V and +67dBmV @ 8V Total Composite Output power. 108 to 1791MHz, 280 Ch, SC-QAM, 10dB tilt, 0dB Offset (Source corrected)		45		dB
Noise Figure	50MHz		2.2		dB
	1800MHz		3.6		
OIP2L	+12 dBm / tone output, $\Delta f=53$ MHz, Full Band		85		dBm
OIP2U	+12 dBm / tone output, $\Delta f=53$ MHz, Full Band		75		dBm
OIP3	+12 dBm / tone output, $\Delta f=6$ MHz, Full Band		45/48		dBm
OP1dB	50-1800MHz		26/29		dBm
Thermal Resistance	Θ_{JC} (Junction to Device Heat Slug)		12		°C/W

Note: Typical performance at these conditions: Temp = +25 °C, V_{DD} = +5 V, 75 Ω system, Full band unless otherwise noted

Evaluation Board Schematic 50 MHz – 1800 MHz (Downstream)

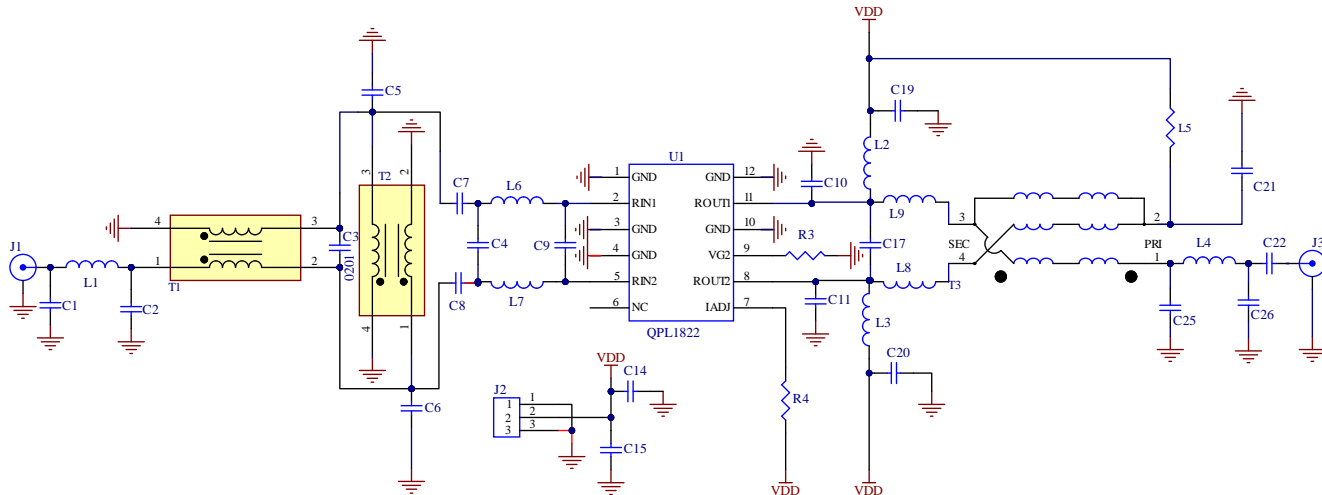

Evaluation Board Assembly Drawing (Downstream)

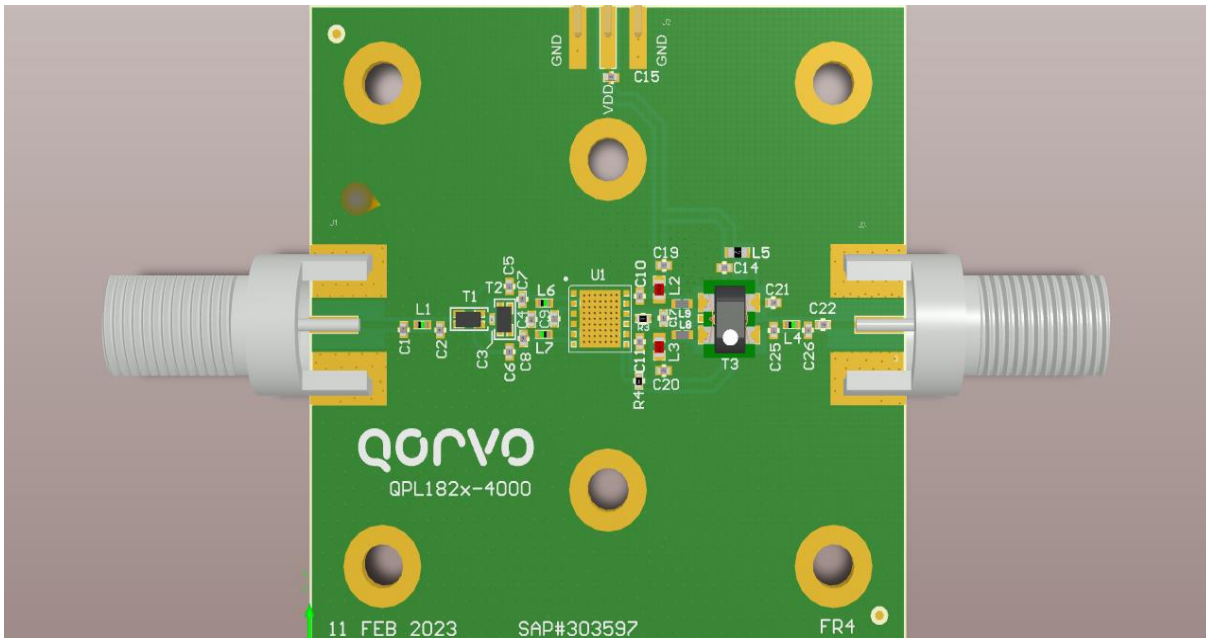

Materials: Isola370HR High-Tg FR4

Layer	Thickness	Primary Stack	Description	Dk / Df
Layer - 1	0.0010 0.0020		Taiyo 4000-HFX DI 1/2oz Mix (Std Plt)	3.50 / 0.0190
Layer - 2	0.0578 0.0020		370H 1/2oz Mix (Std Plt)	4.34 / 0.0180

Evaluation Board Bill of Materials for Downstream 5V

Ref Des	Description	Mfg Name	Mfg Part #
PCB	PCB, QPL182X-4000	Qorvo	QPL1823-4000(A)
C3	CAP, 0.2pF, +/-0.1pF, 25V	MURATA	GJM0335C1ER20BB01D
C4	CAP, 0.7pF, +/-0.1pF, 50V	MURATA	GJM1555C1HR70BB01D
C7, C8	CAP, 1000pF, 5%, 50V, C0G	MURATA	GRM1555C1H102JA01D
C2, C17	CAP, 0.2pF, +/-0.1pF, 50V	MURATA	GJM1555C1HR20BB01D
C14, C19, C20, C21	CAP, 0.01uF, 10%, 50V, X7R	MURATA	GCM155R71H103KA55D
C22	CAP, 470pF, 5%, 50V, C0G	MURATA	GRM1555C1H471JA01D
C15	CAP, 0.1uF, 10%, 25V, X7R	MURATA	GRM155R71E104KE14D
L8, L9	RES, 0 OHM, 5%, 1/10W	Kamaya, Inc	RMC1/16SJPTH
R3	RES, 3.6K, 5%, 1/16W, 0402	Kamaya, Inc	RMC1/16S-362JTH
R4	Res, 1.3K /1%/0402/TK100	Kamaya, Inc	RMC1/16SK1301FTH
L4	IND, 1.2nH, +/-0.3nH, M/L	MURATA	LQG15HN1N2S02D
L6, L7	IND, 2.2nH, +/-0.3nH, M/L	MURATA	LQG15HN2N2S02D
L1	IND, 1nH, +/-0.3nH, M/L	MURATA	LQG15HN1N0S02D
U1	1.8GHZ 5V, 15DB GAIN	Qorvo	QPL1822
L2, L3	FER, BEAD, 1500R, 500mA	MURATA	BLM18HE152SN1D
T1, T2	BALUN, 75 / 75 OHM	MURATA	DXW21BN7511SL07
T3	TFR - 10-1800MHz, 75R	Mini Circuits	TRS1-182-75-7+
J2, J3	CONN, HDR, ST, 3-PIN, 0.100"	SAMTEC INC.	TSW-103-07-G-S
J1, J4	F FEM EDGE MOUNT, 75 OHMS	Millimeter Wave Tech	MW-846-C-DD-75
N/A	HEATSINK, 50 x 50 x10	Alpha Nova Tech Inc	S08EFV05-A
C1, C5, C6, C9, C10, C11, C25, C26, L5	NOT POPULATED ITEM		DUMMY PART

BOM Changes for Downstream 8V Operation

R4	RES, 2.0K OHM, 5%, 1/16W, 0402	Kamaya	RMC1/16-202JTH
----	--------------------------------	--------	----------------

**Electrical Specifications (Upstream)**

Parameter	Condition (1)	Min	Typ	Max	Unit
Supply Voltage (VDD)			5/8		V
Supply Current (IDD)			260/350		mA
Frequency Range		5		700	MHz
Gain at 5 MHz			15		dB
Gain at 700 MHz			15		dB
Gain Slope			0		dB
Reverse Isolation			20		dB
Input Return Loss	5 – 700MHz		-20		dB
Output Return Loss	5 – 700MHz		-20		dB
MER	At +65.5dBmV @ 5V and +69dBmV @ 8V Total Composite Output power. 5MHz to 700MHz, 112 Ch, SC-QAM, 0dB tilt, 0dB Offset (Source corrected)		45		dB
Noise Figure	5-700MHz		2.3		dB
OIP2L	+12 dBm / tone output, $\Delta f=53$ MHz, Full Band		90		dBm
OIP2U	+12 dBm / tone output, $\Delta f=53$ MHz, Full Band		80		dBm
OIP3	+12 dBm / tone output, $\Delta f=6$ MHz, Full Band		46/49		dBm
OP1dB	5-700MHz		26/29		dBm
Thermal Resistance	Θ_{JC} (Junction to Device Heat Slug)		12		$^{\circ}\text{C/W}$

Note: Typical performance at these conditions: Temp = +25 $^{\circ}\text{C}$, V_{DD} = +5 V, 75 Ω system, Full band unless otherwise noted

Evaluation Board Schematic 5 MHz – 700 MHz (Upstream)

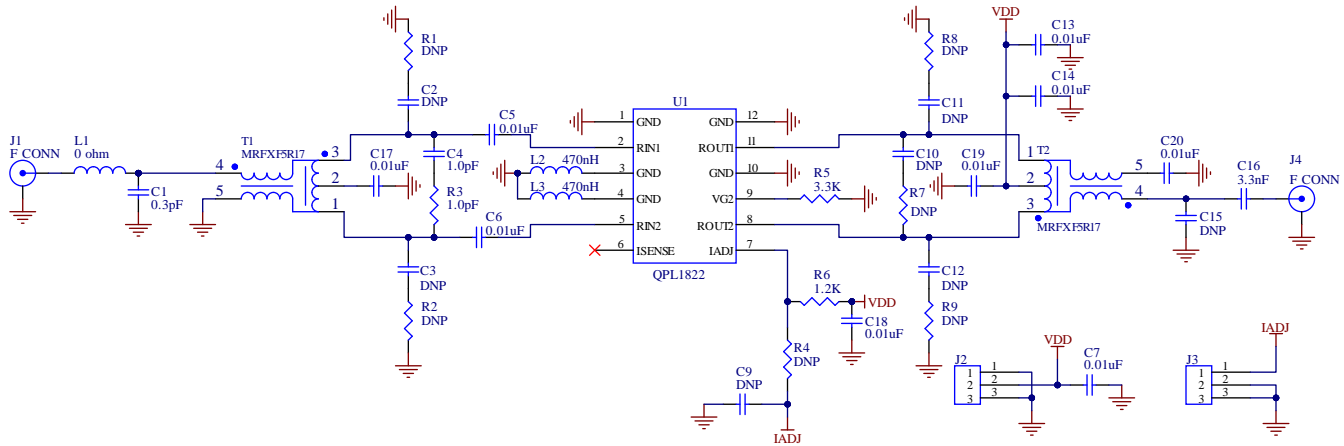

Evaluation Board Assembly Drawing (Upstream)

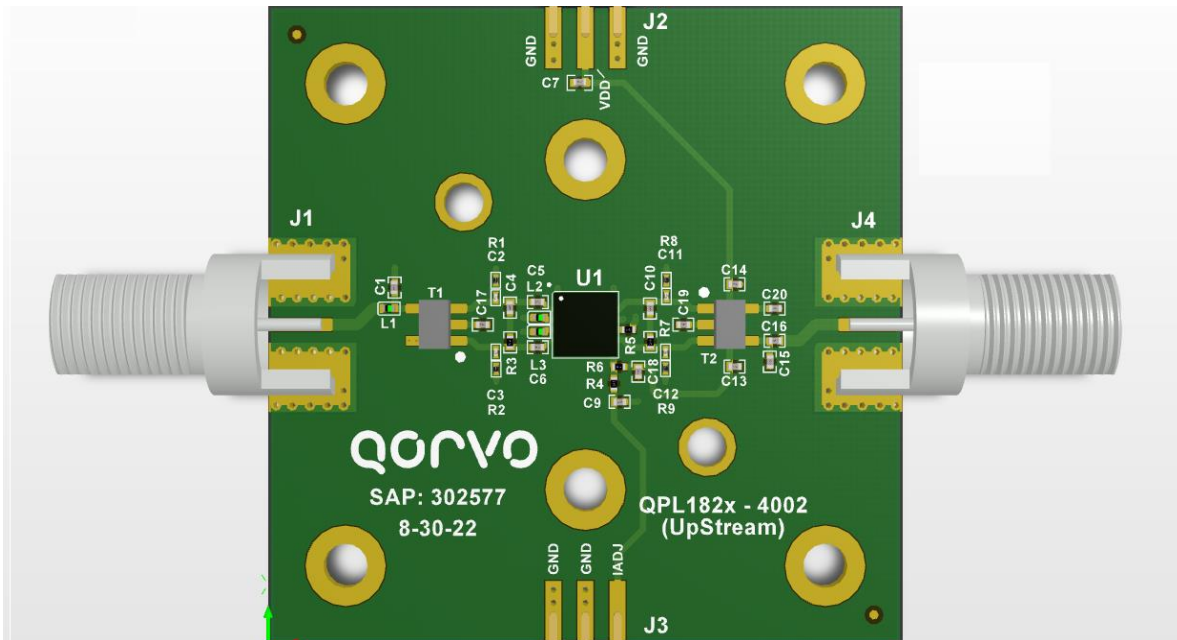

Materials: Isola370HR High-Tg FR4

Layer	Thickness	Primary Stack	Description	Dk / Df
Layer - 1	0.0010 0.0020		Taiyo 4000-HFX DI 1/2oz Mix (Std Plt)	3.50 / 0.0190
Layer - 2	0.0578		370H	4.34 / 0.0180
Layer - 2	0.0020		1/2oz Mix (Std Plt)	



Evaluation Board Bill of Materials for Upstream 5V

Ref Des	Description	Mfg Name	Mfg Part #
PCB	PCB, QPL182X-4002	Qorvo	QPL1820-4002(A)
C1	CAP, 0.3pF, +/-0.1pF, 25V, 0201	MURATA	GJM0335C1ER30BB01D
C5, C6, C7, C13, C14, C17, C18, C19, C20	CAP, 0.01uF, 10%, 50V, X7R, 0402	MURATA	GCM155R71H103KA55D
C4, R3	CAP, 1pF, +/-0.05pF, 50V, 0402	MURATA	GJM1555C1H1R0WB01D
C16	CAP, 3300pF, 10%, 50V, X7R, 0402	Kemet	C0402C332K5RACTU
L1	RES, 0 OHM, 5%, 1/10W, 0402	Kamaya, Inc	RMC1/16SJPTH
R6	RES, 680 OHM, 5%, 1/16W, 0402	Kamaya, Inc	RMC1/16S-681JTH
R5	RES, 3.3K, 5%, 1/16W, 0402	Kamaya, Inc	RMC1/16S-332JTH
L2, L3	IND, 470nH, 5%, 310mA,0402	Coilcraft, Inc.	0402AF-471XJLW
U1	1.8GHZ 5V, PUSH PULL, 15DB GAIN	Qorvo	QPL1822
T1, T2	XFMR, BALUN, 1:1, 5-700MHz,	MiniRF, Inc.	MRFXF5R17
	SCREW, M3 x 6mm, SHCS, SS	McMaster-Carr	91292A111
J2, J3	CONN, HDR, ST, 3-PIN, 0.100"	SAMTEC INC.	TSW-103-07-G-S
J1, J4	CONN, F FEM EDGE MOUNT,	Millimeter Wave	MW-846-C-DD-75
N/A	HEATSINK, 50 x 50 x10	Alpha Nova Tech	S08EFV05-A
C2, C3, C9, C10, C11, C12, C15, R1, R2, R4, R7, R8, R9	NOT POPULATED ITEM		DUMMY PART

BOM Changes for Upstream 8V Operation

R6	RES, 1.2K OHM, 1%, 1/16W, 0402	Kamaya	RMC 1/16S-122JTH
----	--------------------------------	--------	------------------

Performance Data, Downstream 5V

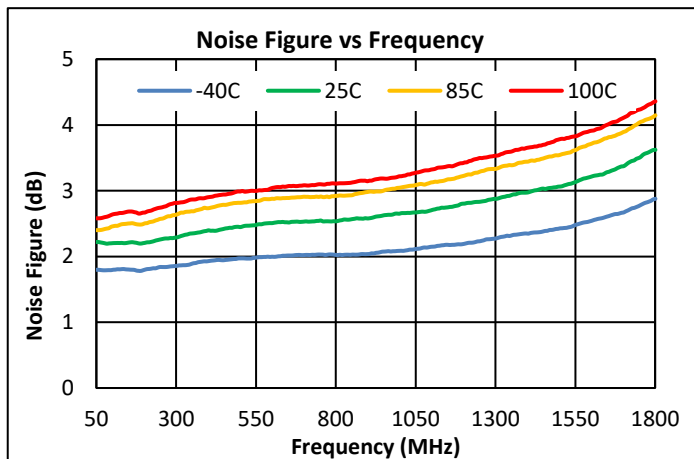
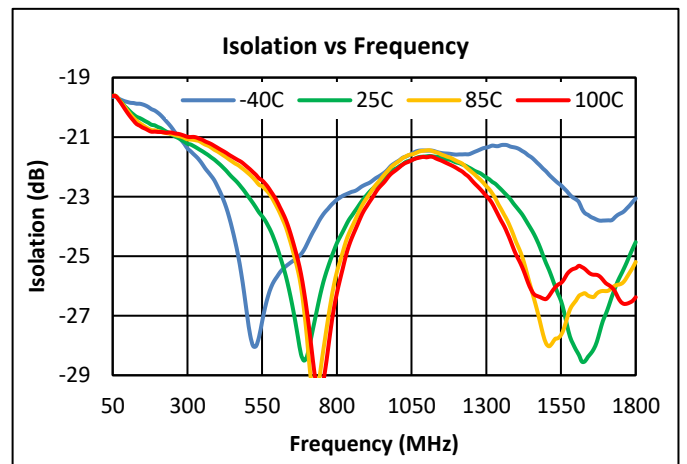
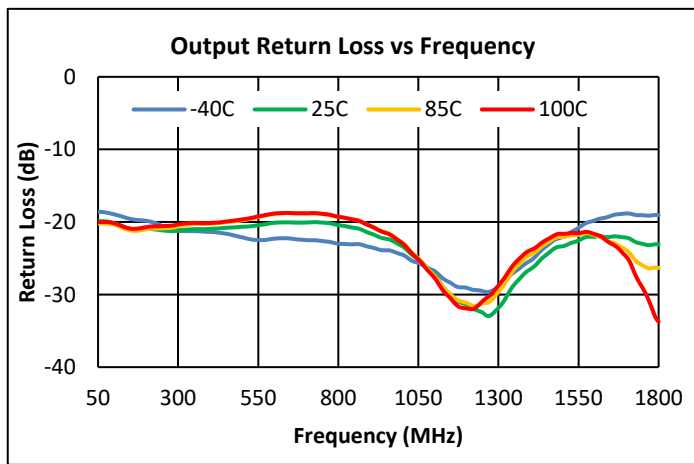
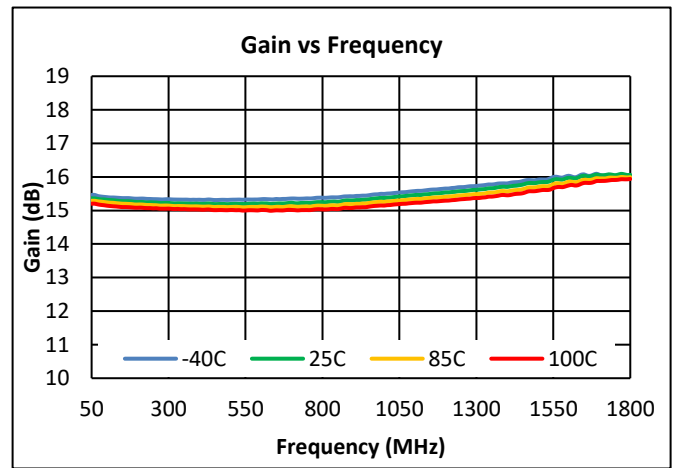
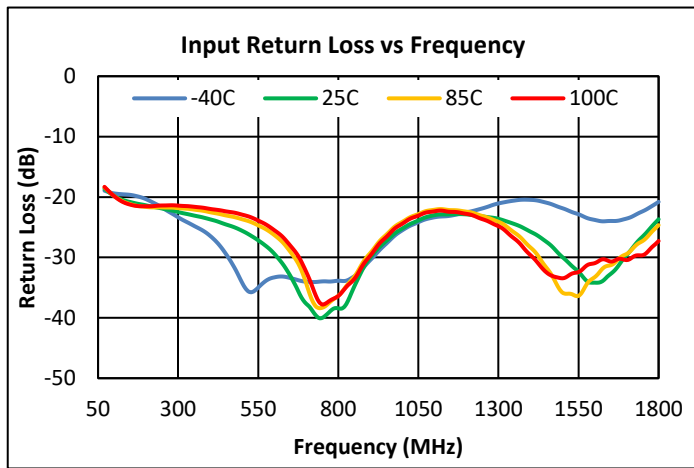

Performance Data, Downstream 5V (cont'd)

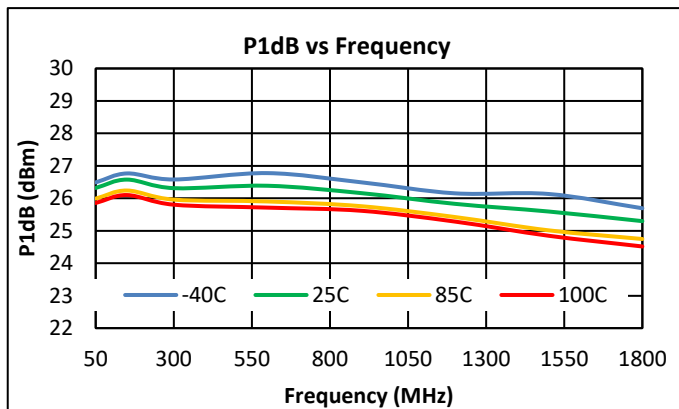
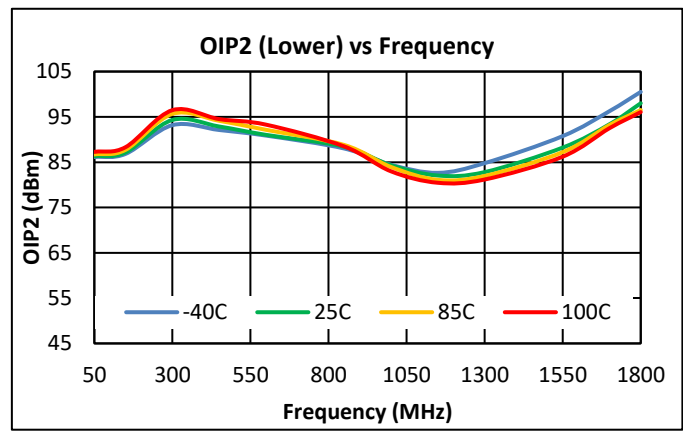
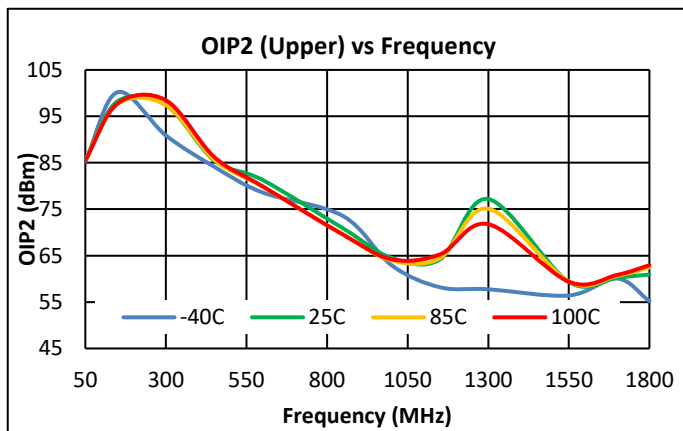
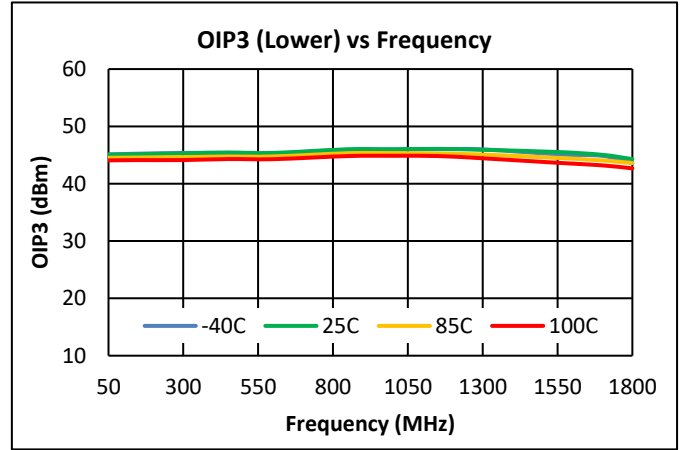
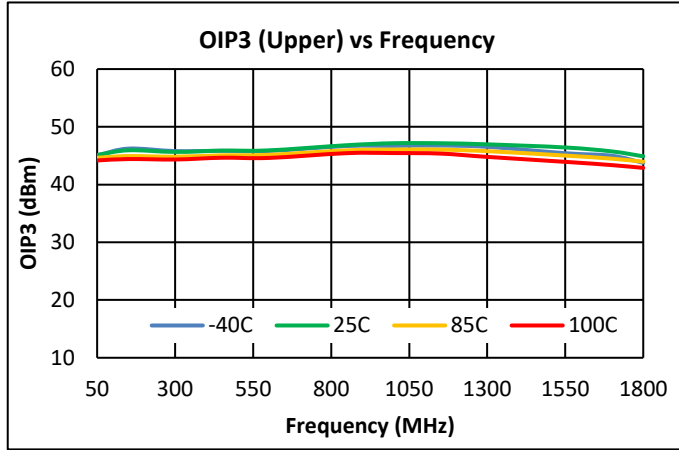

Notes:

- (1) 5V OIP3: +12dBm / tone output @ Δf = 6MHz
- (2) 5V OIP2: +12dBm / tone output @ Δf = 53MHz

Performance Data, Downstream 5V (cont'd)

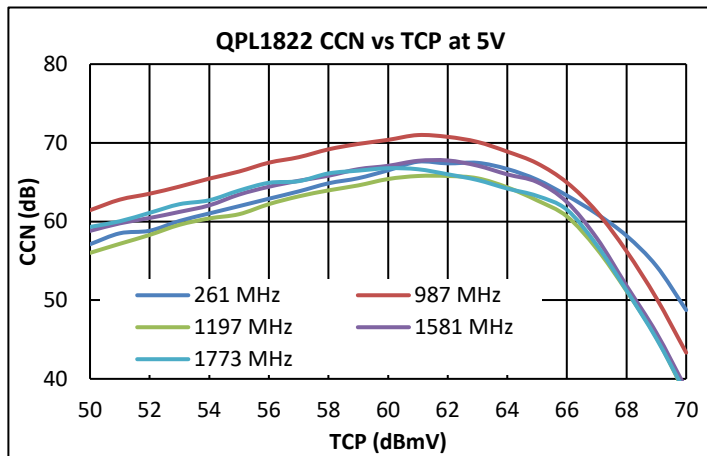
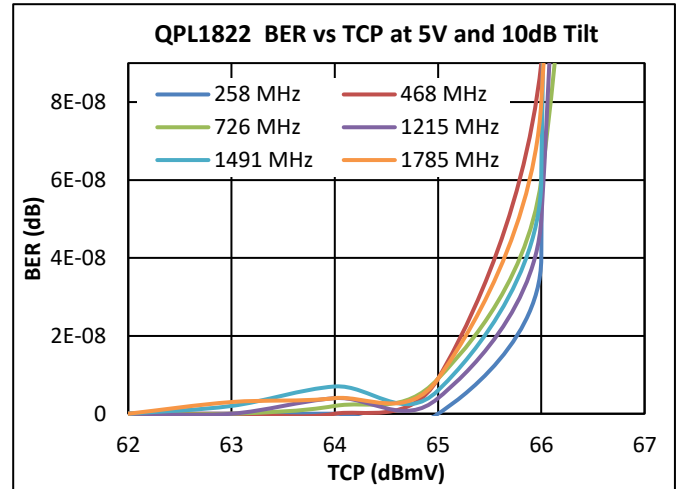
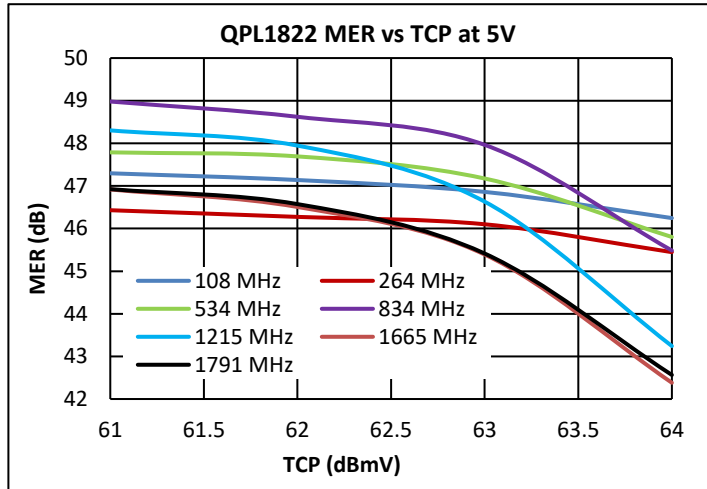

Notes:

- (1) MER & BER Test Conditions: (261 – 1791 MHz, 280 Ch SC-QAM, 10dB tilt, 0dB offset)
- (2) MER is uncorrected
- (3) CCN Test conditions: 10dB tilt, 6dB offset at 1.026GHz, 261-1791MHz loading

Performance Data, Downstream 8V

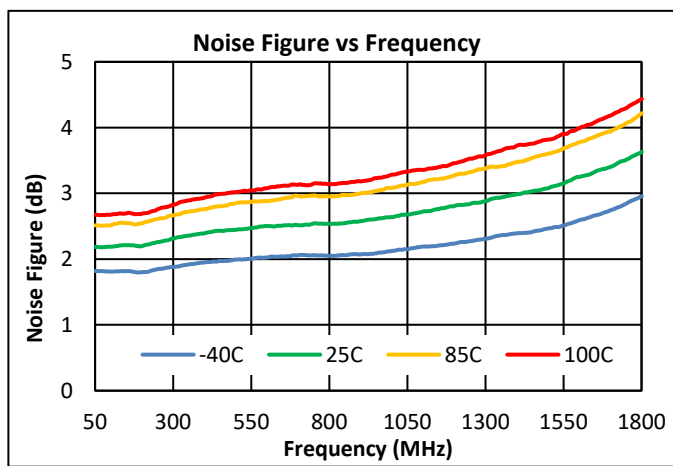
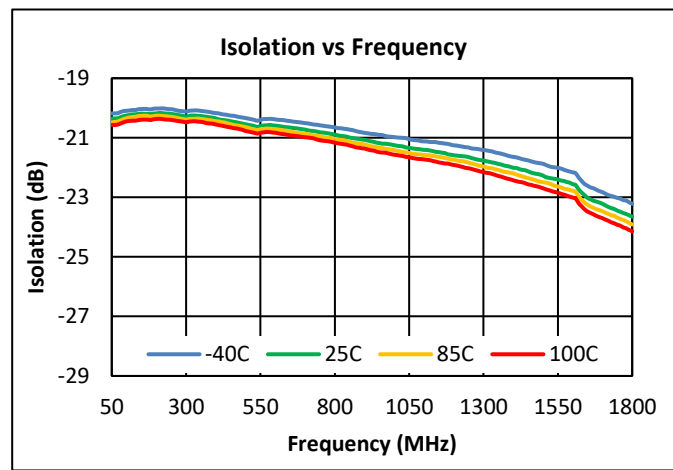
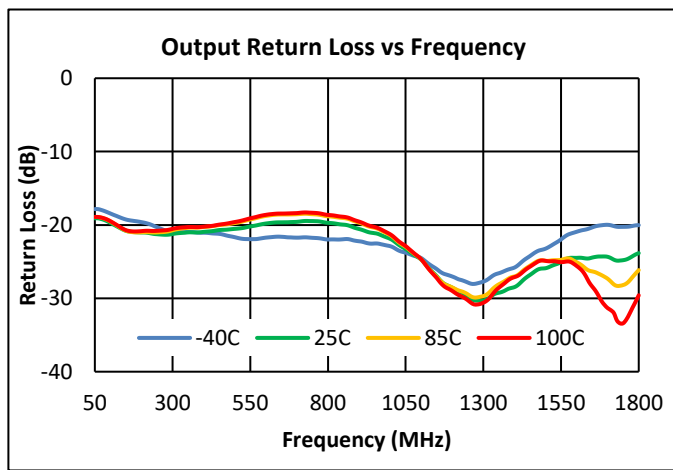
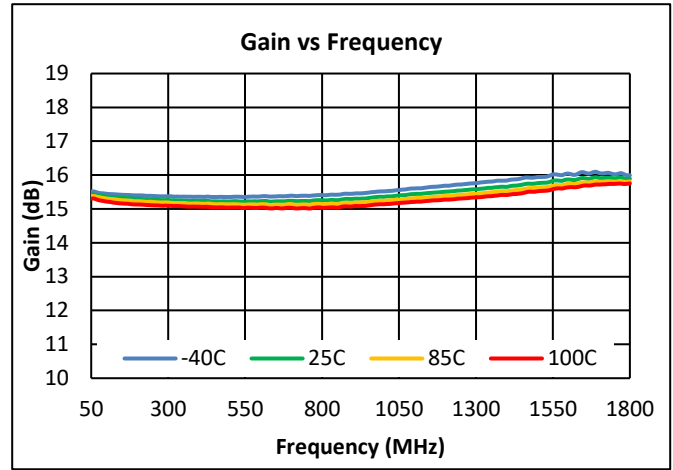
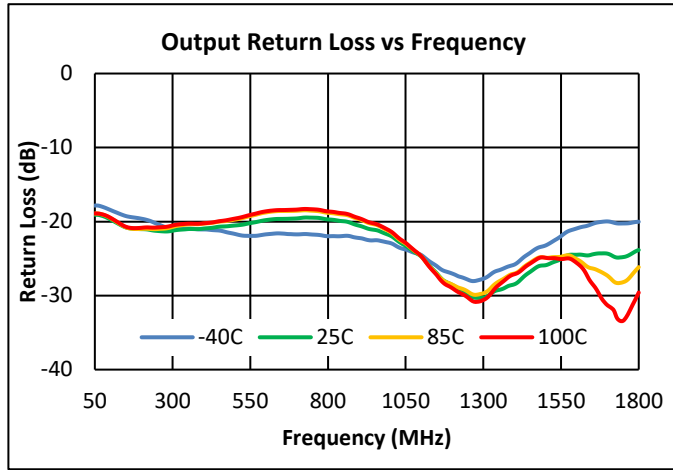

Performance Data, Downstream 8V (Cont'd)

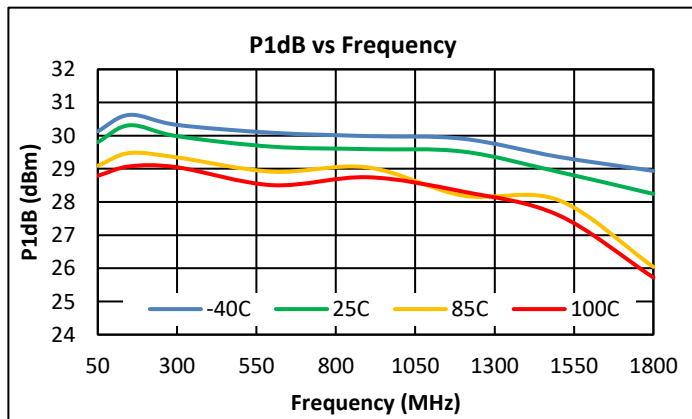
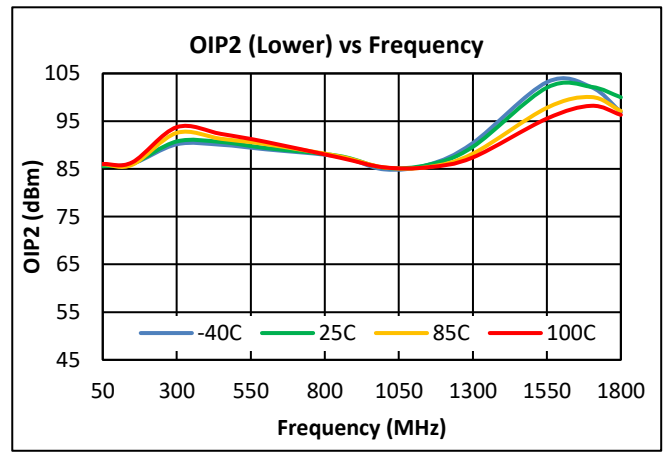
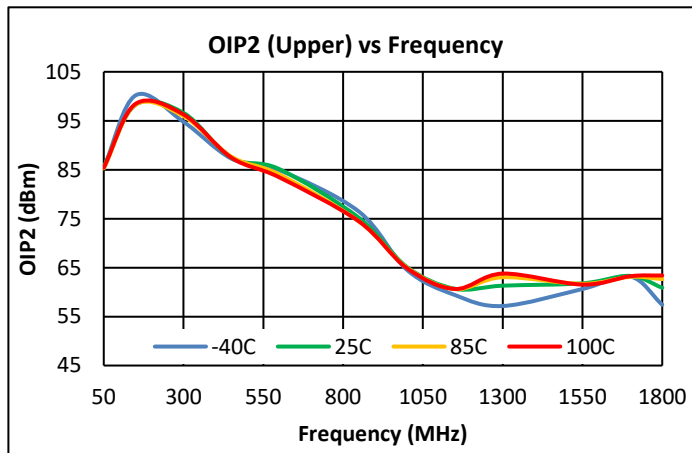
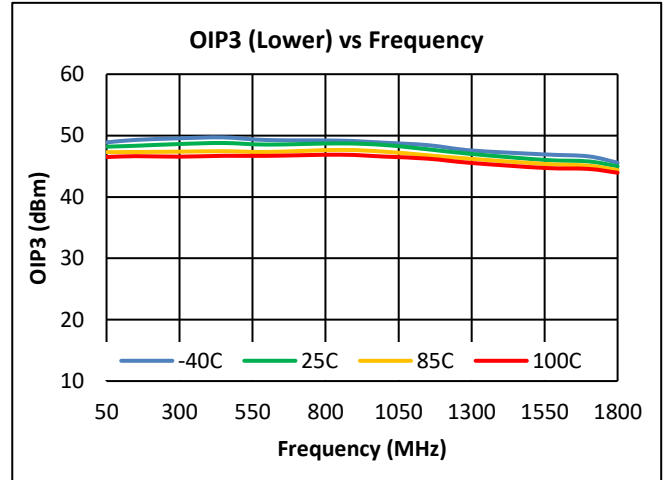
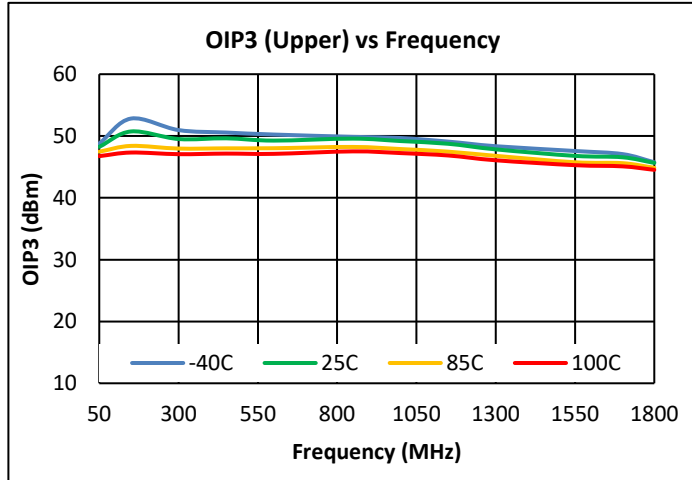

- Notes:
- (1) 8V OIP3: +15dBm /tone output @ $\Delta f = 6\text{MHz}$
 - (2) 8V OIP2: +15dBm/tone output @ $\Delta f = 53\text{MHz}$

Performance Data, Downstream 8V (Cont'd)

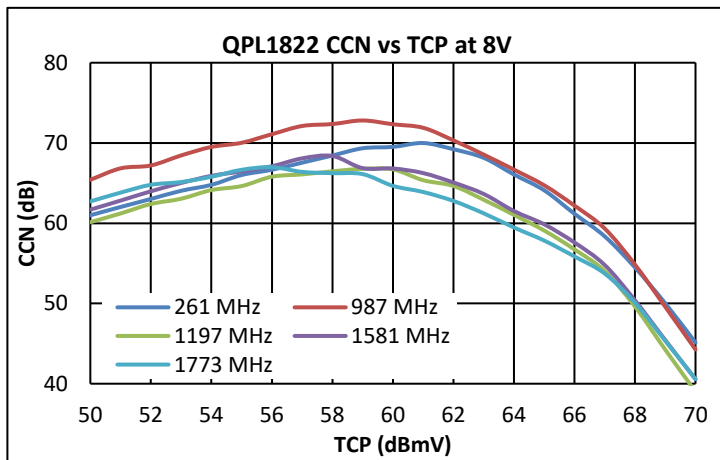
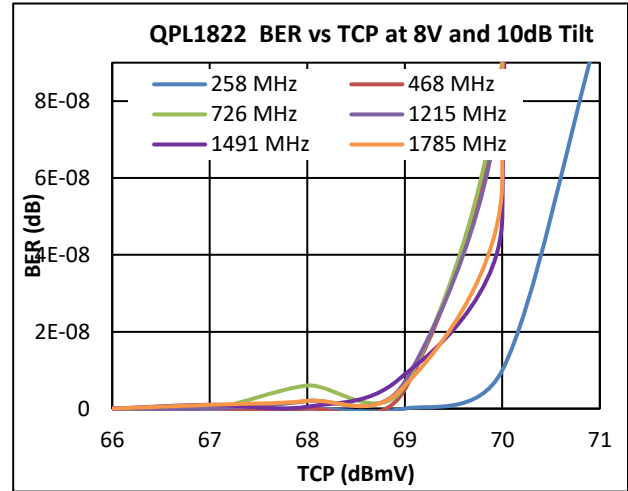
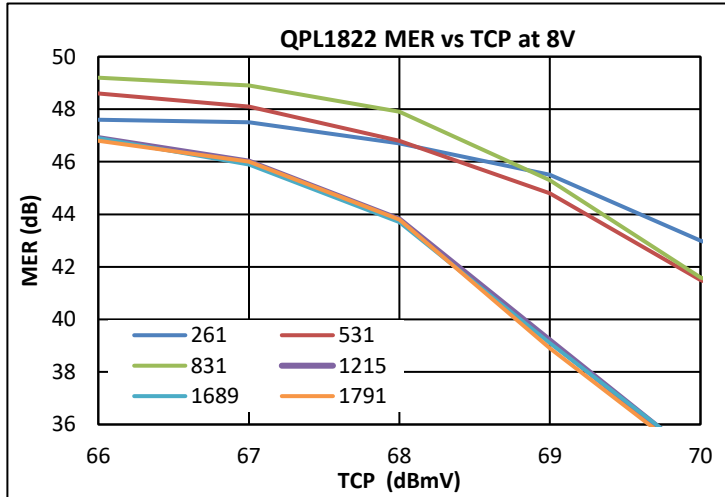

Notes:

- (1) MER & BER Test Conditions: (261 – 1791 MHz, 280 Ch SC-QAM, 10dB tilt, 0dB offset)
- (2) MER is uncorrected
- (3) CCN Test conditions: 10dB tilt, 6dB offset at 1.026GHz, 261-1791MHz loading

Performance Data, Upstream 5V

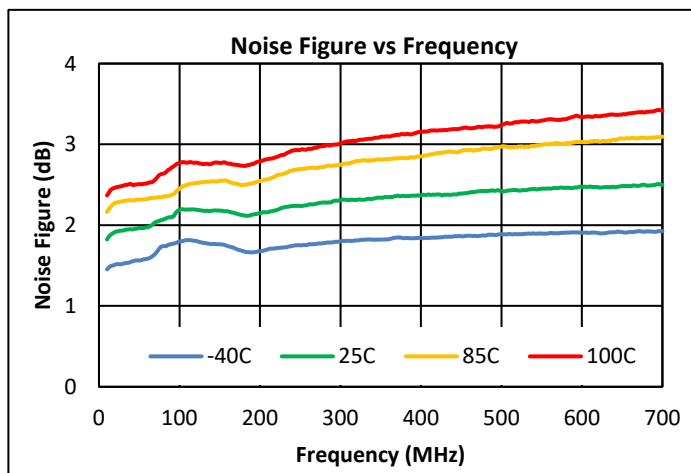
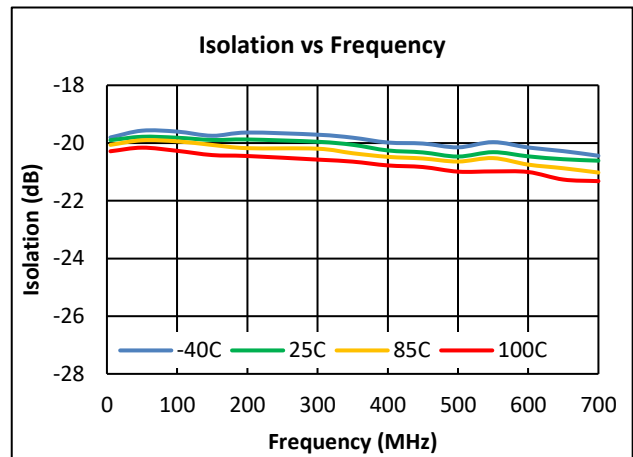
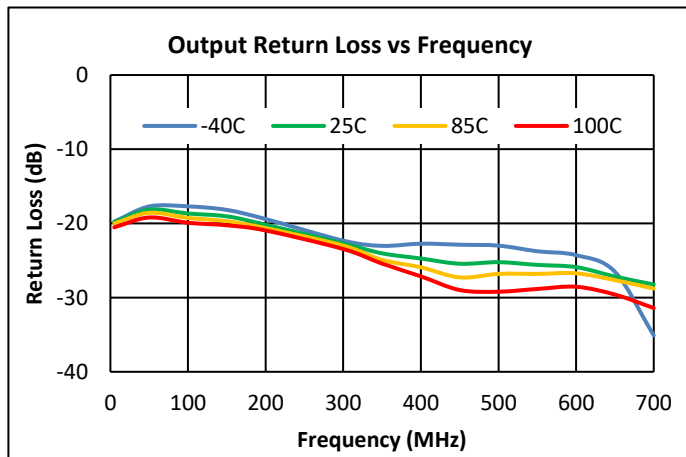
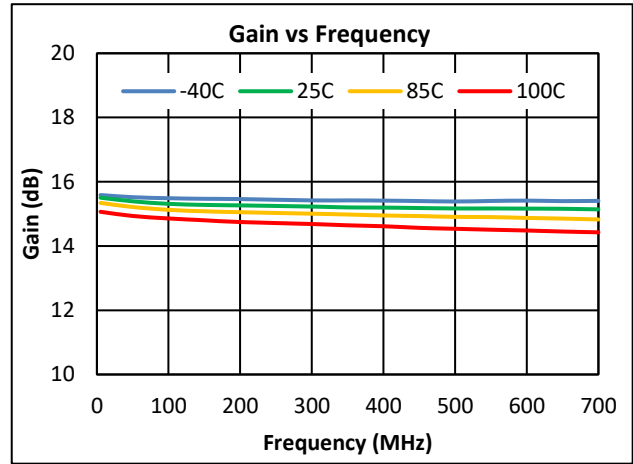
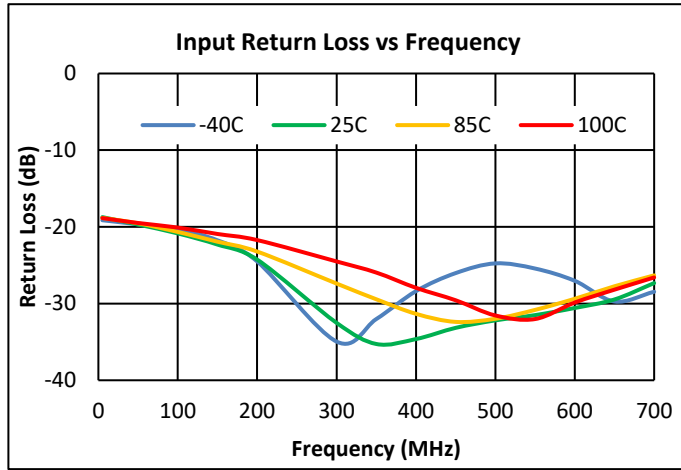

Performance Data, Upstream 5V (Cont'd)

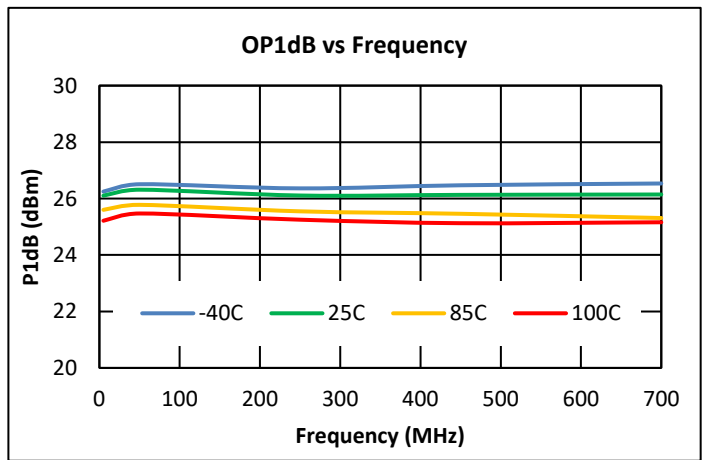
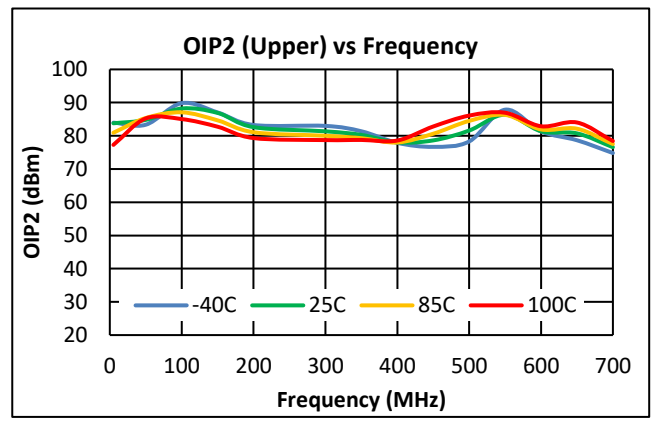
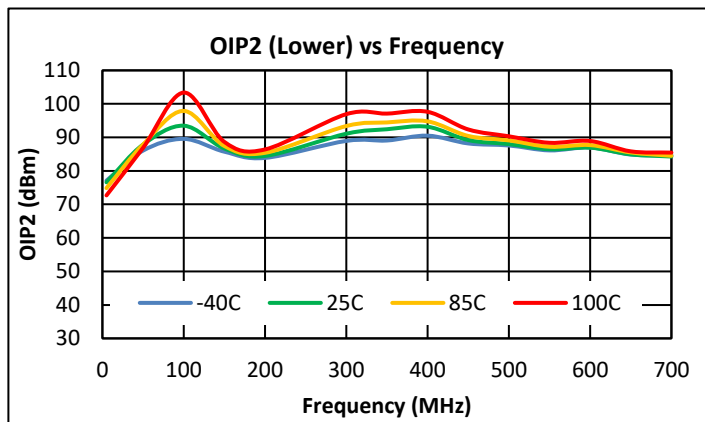
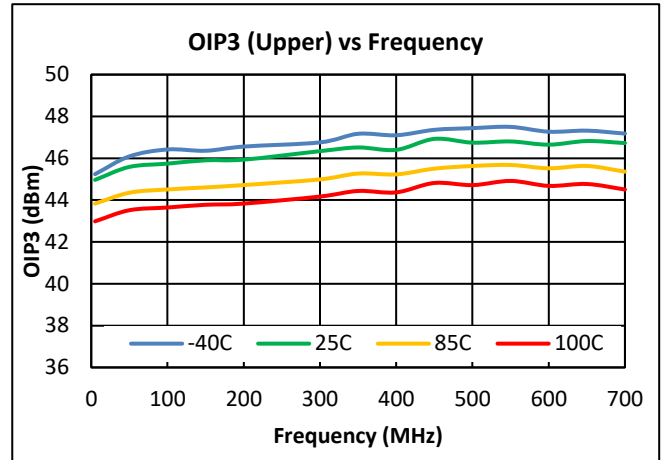
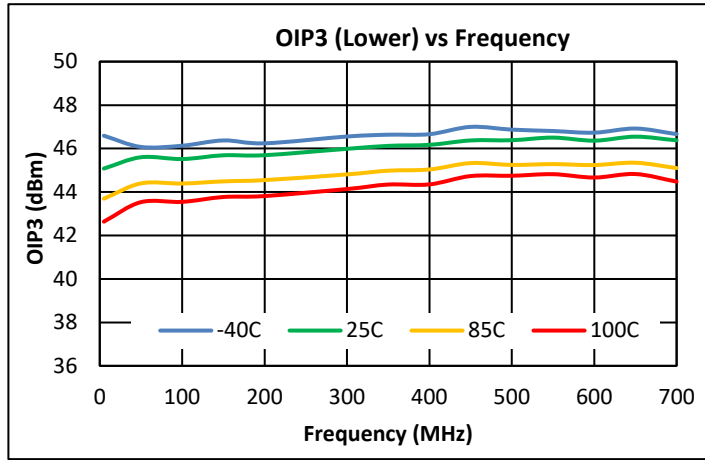

Notes:

- (1) 5V OIP3: +12dBm / tone output @ $\Delta f = 6\text{MHz}$
- (2) 5V OIP2: +12dBm / tone output @ $\Delta f = 53\text{MHz}$

Performance Data, Upstream 5V (Cont'd)

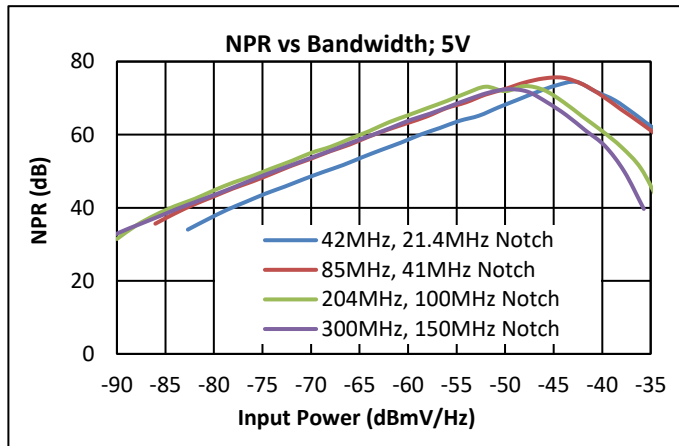
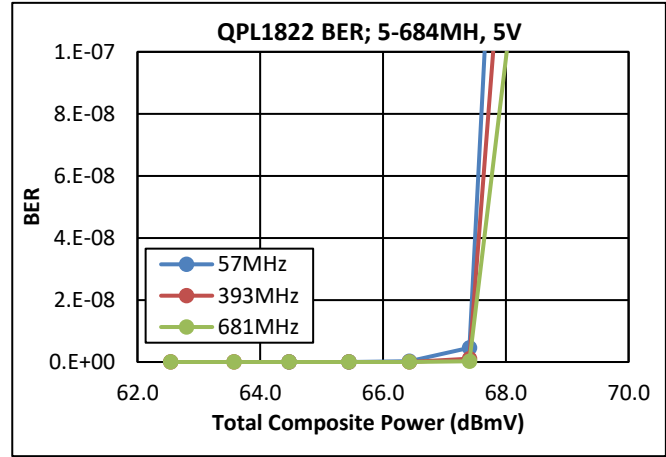
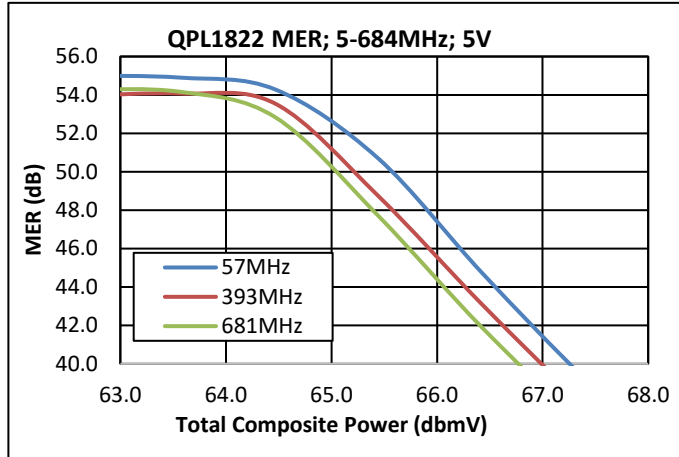

Notes:

- (1) MER & BER Test Conditions: (5 – 694 MHz, 111 Ch SC-QAM, 0dB tilt)
- (2) MER is source corrected

Performance Data, Upstream 8V

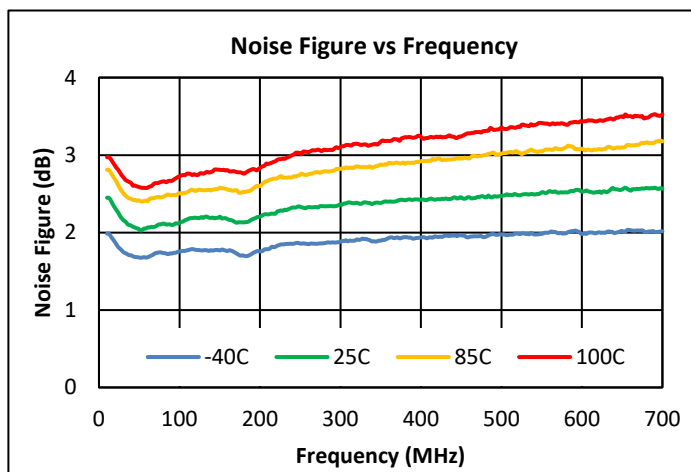
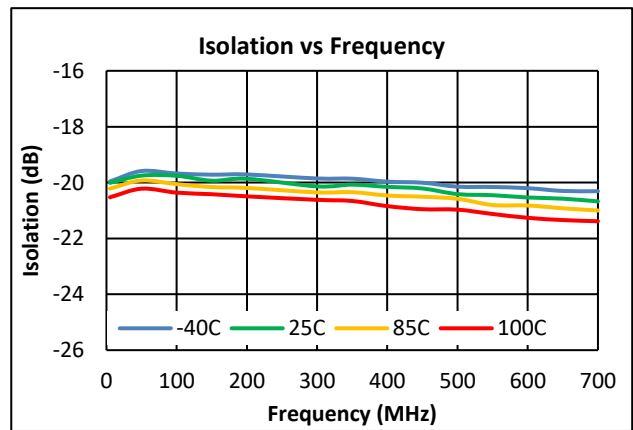
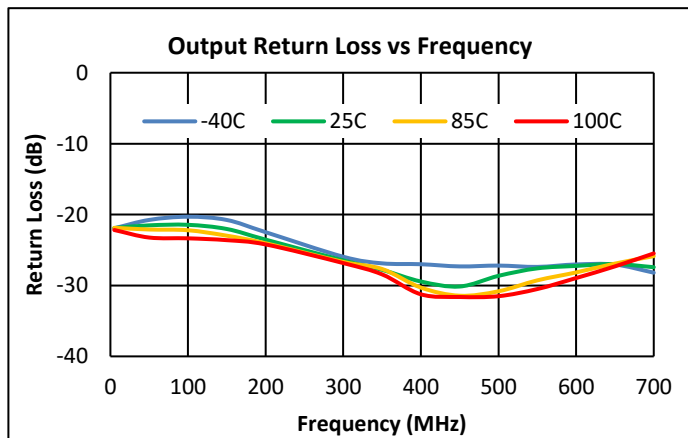
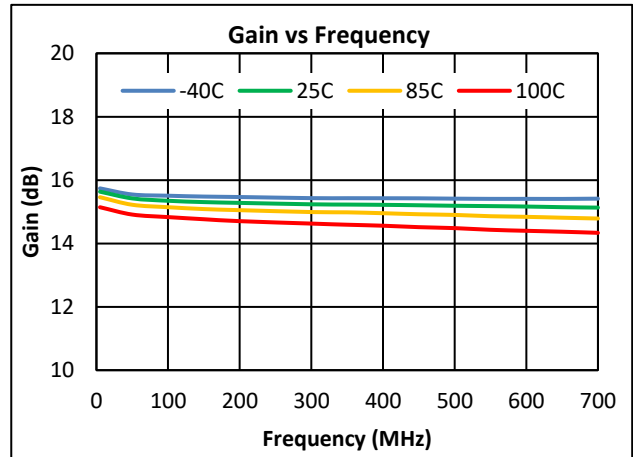
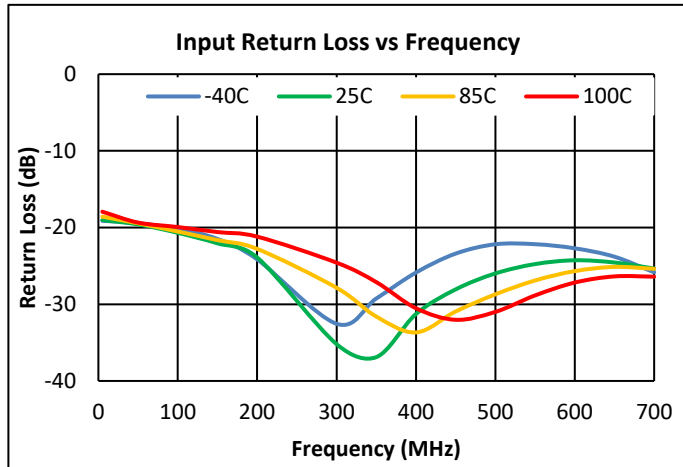

Performance Data, Upstream 8V (Cont'd)

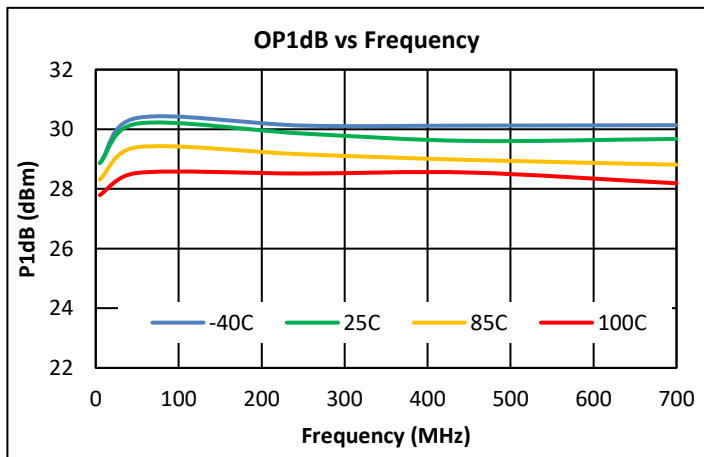
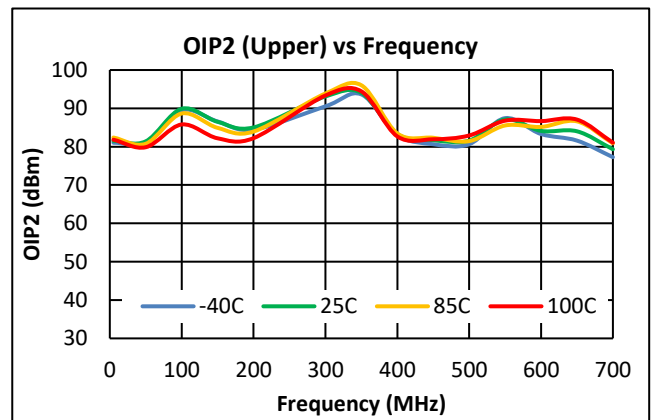
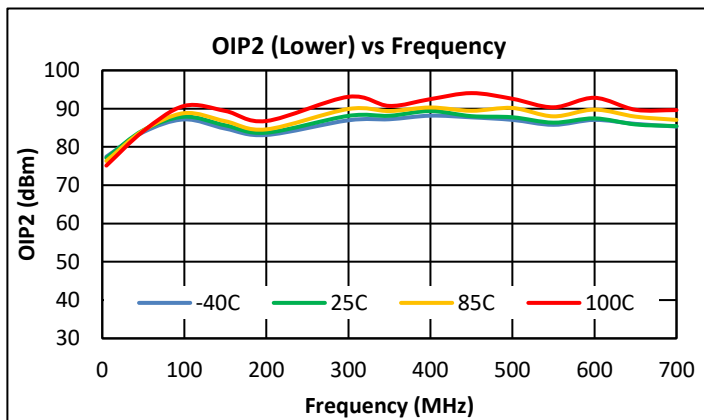
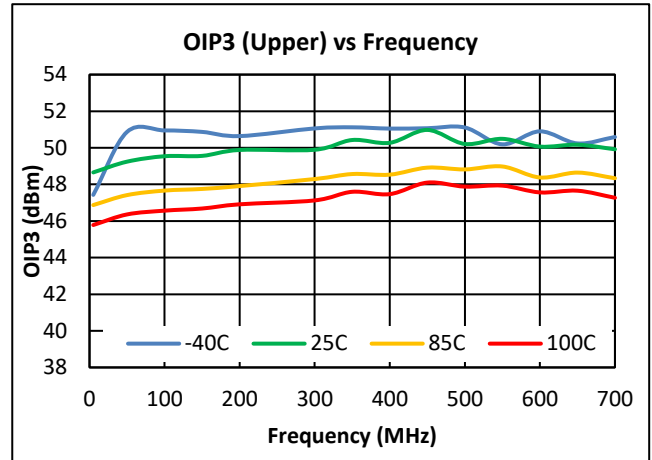
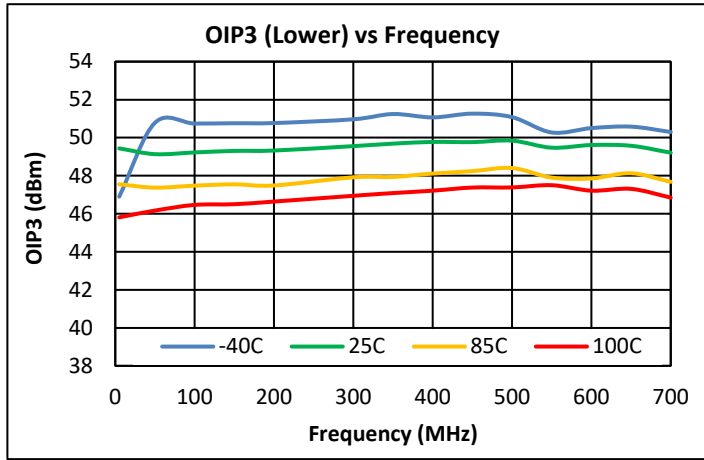

- Notes:
- (1) 8V OIP3: +15dBm/ tone output @ $\Delta f = 6\text{MHz}$
 - (2) 8V OIP2: +15dBm/ tone output @ $\Delta f = 53\text{MHz}$

Performance Data, Upstream 8V (Cont'd)

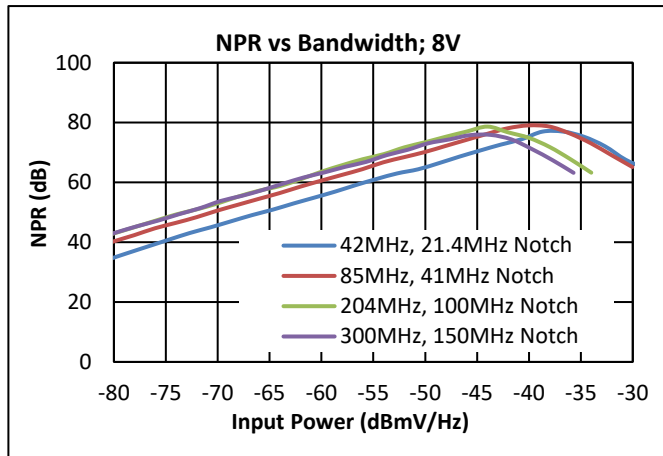
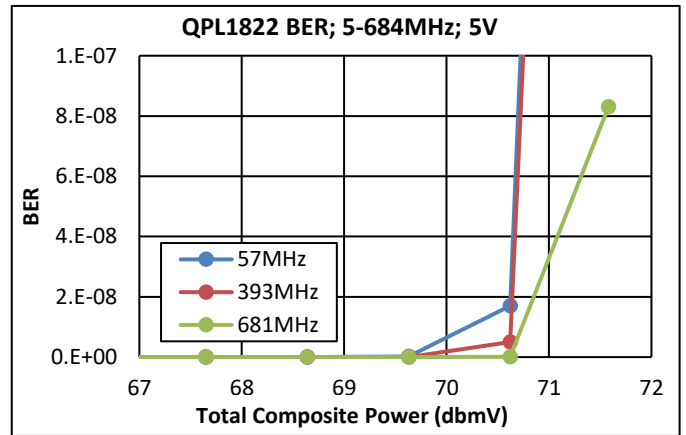
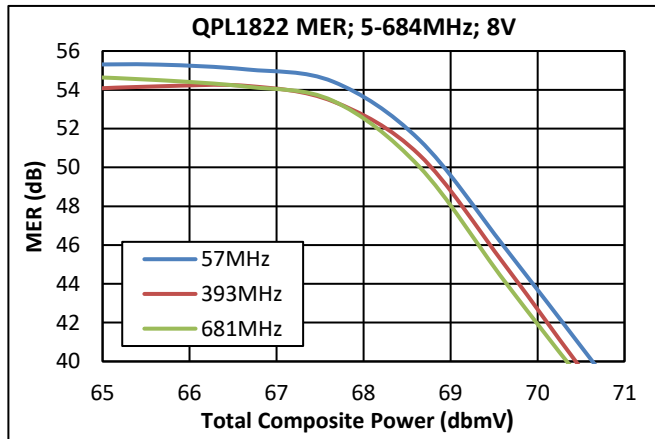

Notes:

- (1) MER & BER Test Conditions: (5 – 694 MHz, 111 Ch SC-QAM, 0dB tilt)
- (2) MER is corrected

IADJ Resistor Value

The Resistor Rbias is used to set the device current. In the application circuit, the value of Rbias is set to get an IDD of 260mA which is optimal for linearity at 5V. In applications where higher linearity is required, or higher supply rail is present, the IDD can be adjusted by varying the value of Rbias. (See graph below for downstream application)

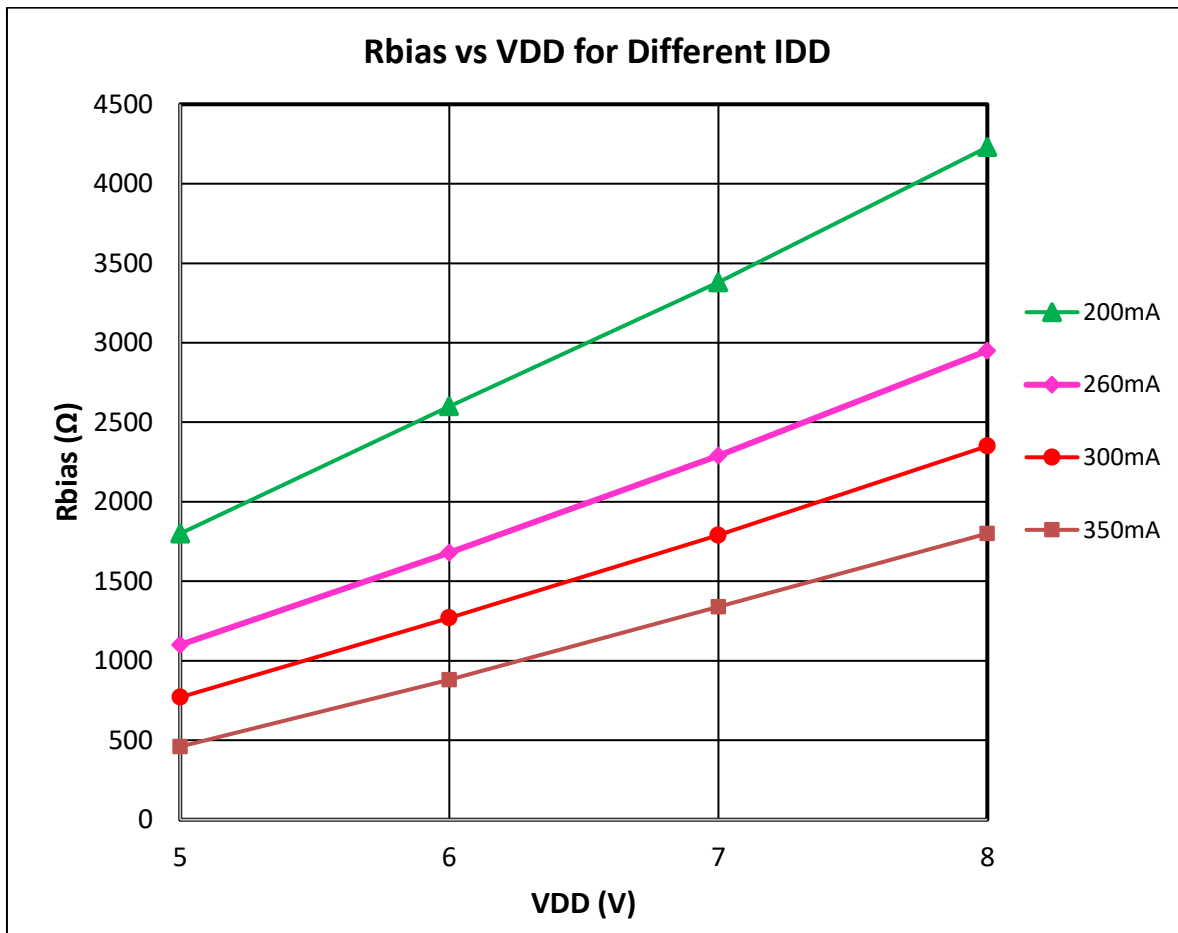

Pin Configuration and Description

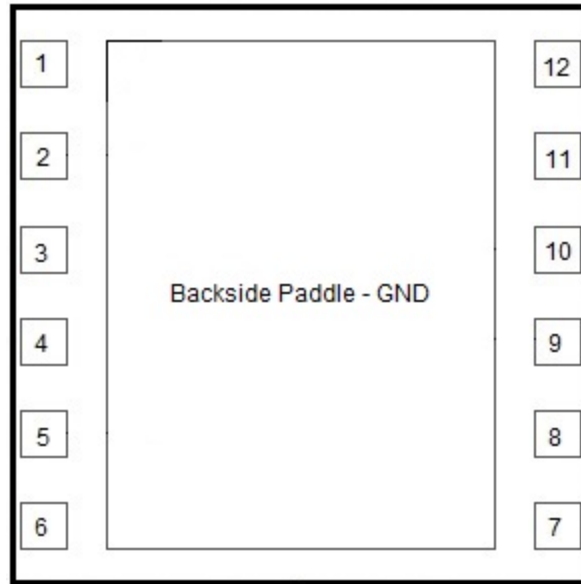

5 x 5 12-pin Laminate MCM

Pin Number	Label	Description
1	NC	No internal connection, recommend connecting to EVB GND
2	RFIN+	RF Input +
3	GND	Must be connected to EVB GND
4	GND	Must be connected to EVB GND
5	RFIN-	RF input -
6	NC	No connect pin. Leave it open. Do not connect to GND.
7	IADJ	IDD current set
8	RFOUT-/VDD2	RF output - and VDD through RF Choke
9	VG2	Cascode device bias resistor divider
10	NC	No internal connection, recommend connecting to EVB GND
11	RFOUT+/VDD	RF output + and VDD through RF Choke
12	NC	No internal connection, recommend connecting to EVB GND
Paddle	GND	DC/RF/Thermal/GND. (Maximize vias in this area)

Package Outline

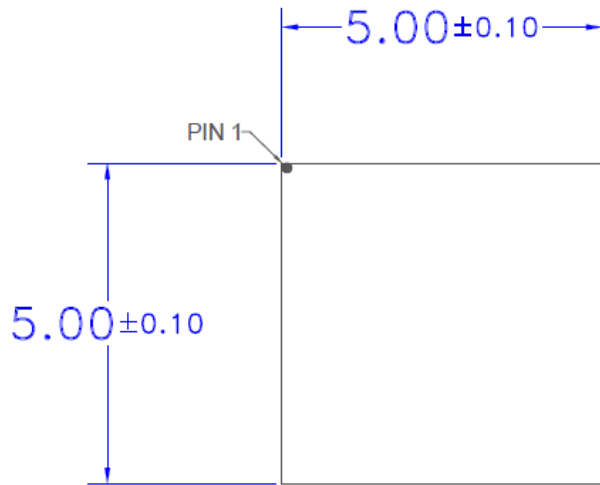

TOP VIEW

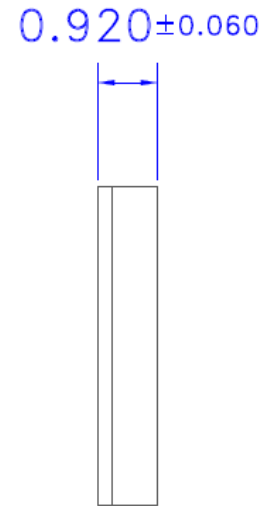

SIDE VIEW

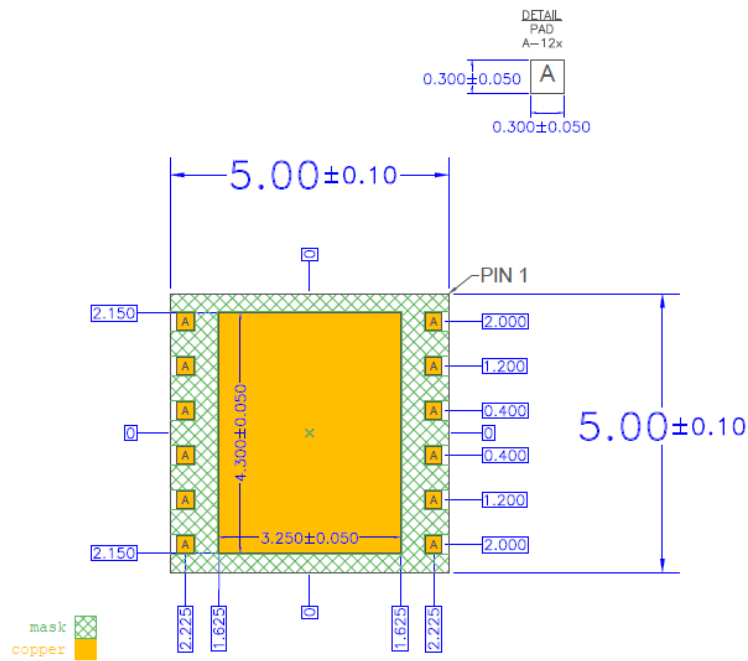

BOTTOM VIEW

Package Marking

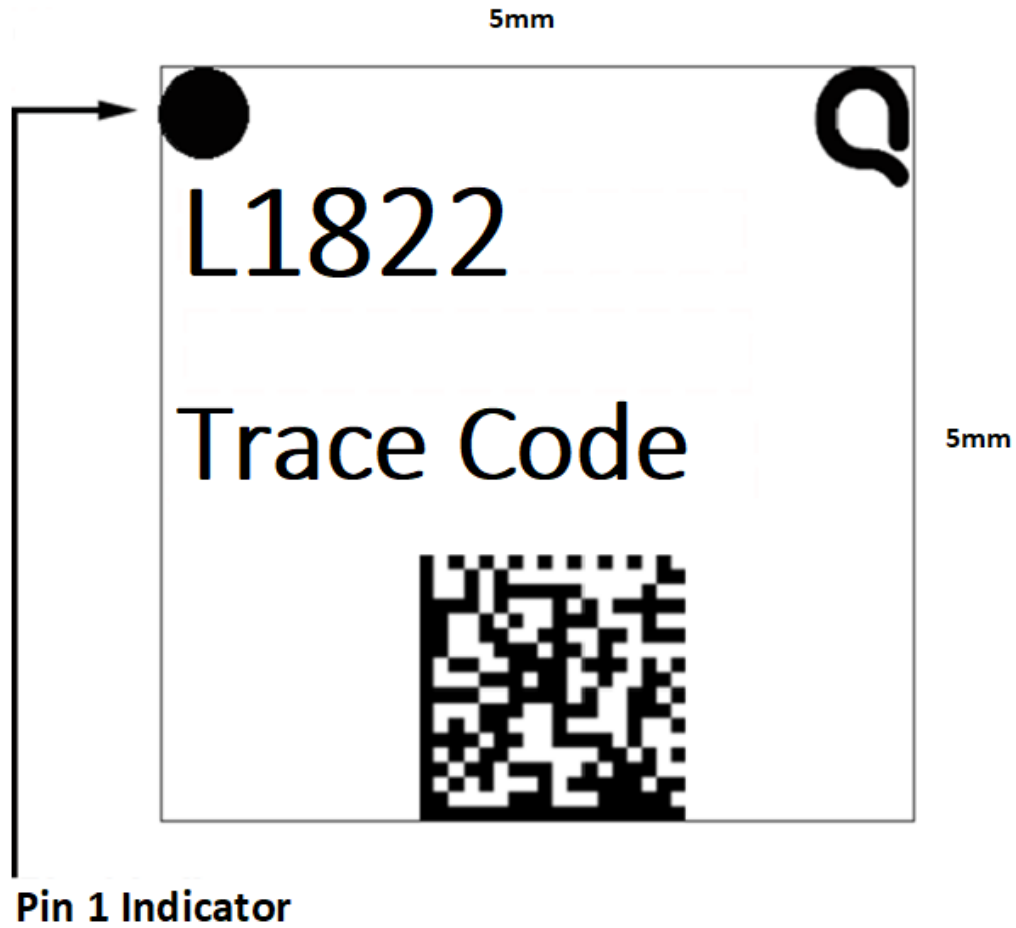

Handling Precautions

Parameter	Rating	Standard	 Caution! ESD Sensitive Device
ESD – Human Body Model (HBM)	Class 1B (500V to <1000V)	ANSI / ESDA / JEDEC JS-001	
ESD – Charged Device Model (CDM)	Class C3 ($\geq 1000V$)	ANSI / ESDA / JEDEC JS-002	
MSL – Moisture Sensitivity Level	MSL3	IPC / JEDEC J-STD-020	

Solderability

Compatible with both lead-free (260 °C max. reflow temp.) and tin / lead (245 °C max. reflow temp.) soldering processes.

Solder profiles available upon request.

Contact plating: ENEPIG

RoHS Compliance

This part is compliant with 2011/65/EU RoHS directive (Restrictions on the Use of Certain Hazardous Substances in Electrical and Electronic Equipment) as amended by Directive 2015/863/EU.

This product also has the following attributes:

- PFOS Free
- Halogen Free (Chlorine, Bromine)
- Antimony Free
- TBBP-A (C₁₅H₁₂Br₄O₂) Free
- SVHC Free

Contact Information

For the latest specifications, additional product information, worldwide sales and distribution locations:

Tel: 1-844-890-8163

Web: www.qorvo.com

Email: customer.support@qorvo.com