

### Product Overview

The QPL1823 is an ultra-linear, GaAs pHEMT, differential RF amplifier. The device features a cascode design which provides 26dB of flat gain along with very low distortion from 5MHz to 1.8GHz. This ultra-linear IC is designed to support Broadband CATV DOCSIS 4.0 applications, such as Nodes, Amplifiers, and Remote PHY Devices, as well as Fiber to The Home (FTTH), Home Gateways, and Cable Modems. The device is powered by a single supply that can operate from 5V to 8V and current can be set from 260 mA to 350 mA. At 5V and 260 mA the QPL1823 provides an output of 63dBmV TCP with a MER of 45dB. When driven with 8V and 350mA the output is 66.5 dBmV TCP with a MER of 45dB. The QPL1823 is packaged in a 12-pin 5x5 mm<sup>2</sup> Laminate Module

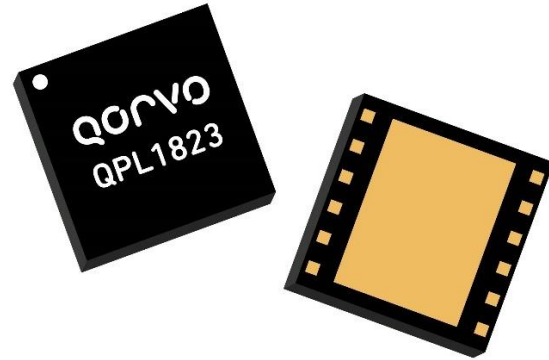

5 x 5 12-pin Laminate MCM Package

### Functional Block Diagram

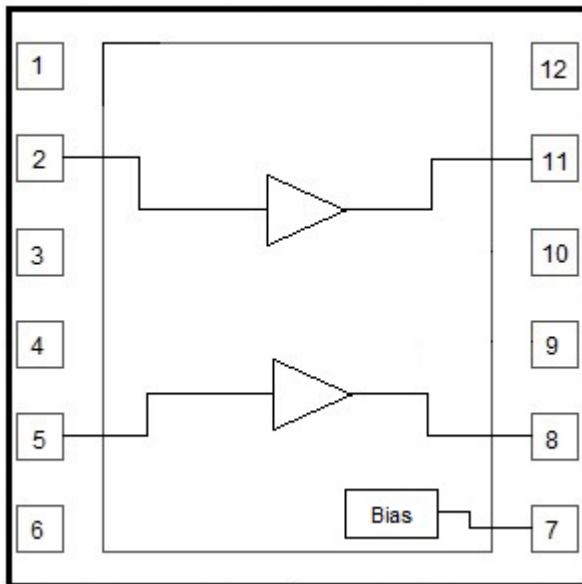

### Key Features

- 5 MHz to 1800 MHz Operation
- 5 V & 8V Operation
- Gain: 26dB Typical
- TCP: 63dBmV @ 5V
- TCP: 66.5dBmV @ 8V
- Noise Figure: 1.6/3.6dB @ 50/1800MHz
- Adjustable Bias Using External Resistors
- RoHS Compliant

### Applications

- DOCSIS 4.0 Amplifiers
- DOCSIS 4.0 Optical Nodes
- DOCSIS 4.0 Remote PHY Devices
- FTTH GPON and GEPON
- DOCSIS 4.0 Cable Modem and Home Gateways

### Ordering Information

Part Number	Description	Part Number	Description
QPL1823EVB-01	5V Downstream Evaluation Board	QPL1823SB	Sample bag with 5 pieces
QPL1823EVB-02	5V Upstream Evaluation Board	QPL1823SR	7" Reel with 100 pieces
QPL1823EVB-03	8V Downstream Evaluation Board	QPL1823TR13	13" Reel with 2500 pieces
QPL1823EVB-04	8V Upstream Evaluation Board		

## Absolute Maximum Ratings

Parameter	Rating
Supply Voltage ( $V_{DD}$ )	+10 V
Supply Current ( $I_{DD}$ )	400 mA
Maximum Input Level	+61 dBmV
Operating Temperature Range (Operating Device Heat Slug Temperature)	-40 to +100 °C
Storage Temperature Range	-65 to +150 °C
Maximum Junction Temperature	+150 °C

Exceeding any one or a combination of the Absolute Maximum Rating conditions may cause permanent damage to the device. Extended application of Absolute Maximum Rating conditions to the device may reduce device reliability.

## Electrical Specifications (Downstream)

Parameter	Condition (1)	Min	Typ	Max	Unit
Supply Voltage ( $V_{DD}$ )			5/8		V
Supply Current ( $I_{DD}$ )			260/350		mA
Frequency Range		50		1800	MHz
Gain at 50 MHz			23.2		dB
Gain at 1800 MHz			26		dB
Gain Slope			2.8		dB
Reverse Isolation			27		dB
Input Return Loss	50 – 1200MHz		-20		dB
	1200 – 1800 MHz		-18		dB
Output Return Loss	50 – 1200MHz		-19		dB
	1200 – 1800MHz		-18		dB
MER	At +63dBmV @ 5V and +66.5dBmV @ 8V Total Composite Output power. 108MHz to 1791MHz, 280 Ch, SC-QAM, 10dB tilt, 0dB Offset (Source corrected)		45		dB
Noise Figure	50MHz		1.6		dB
	1800MHz		3.6		
OIP2L	+12 dBm / tone output, $\Delta f=53$ MHz, Full Band		85		dBm
OIP2U	+12 dBm / tone output, $\Delta f=53$ MHz, Full Band		65		dBm
OIP3	+12 dBm / tone output, $\Delta f=6$ MHz, Full Band		42/45		dBm
OP1dB	50-1800MHz		27/30		dBm
Thermal Resistance	$\Theta_{JC}$ (Junction to Device Heat Slug)		12		°C/W

Note: Typical performance at these conditions: Temp = +25 °C,  $V_{DD}$  = +5 V, 75  $\Omega$  system, Full band unless otherwise noted

### Evaluation Board Schematic 50 MHz – 1800 MHz (Downstream)

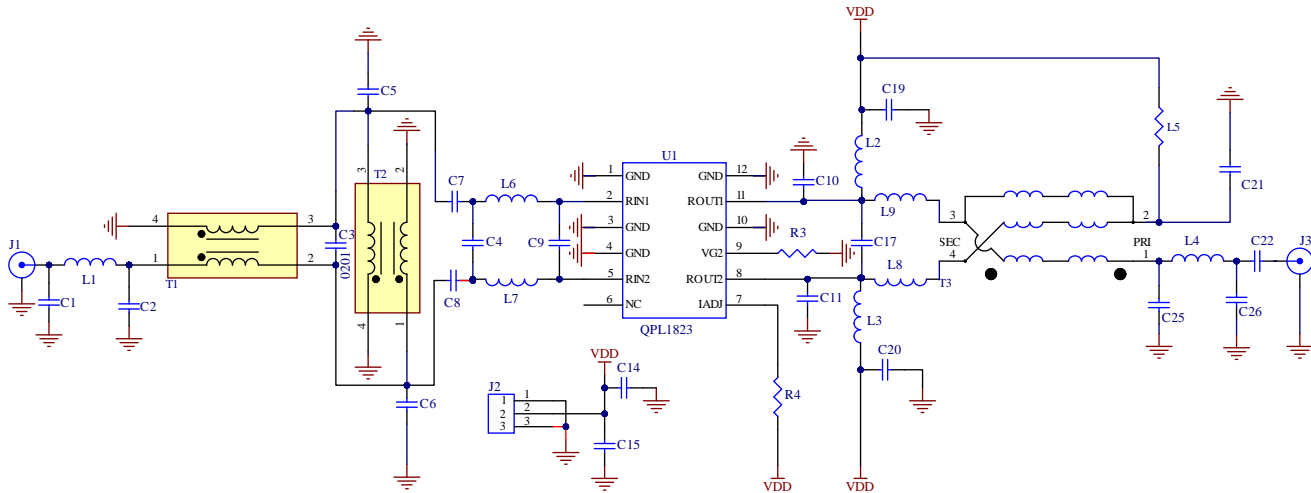

### Evaluation Board Assembly Drawing (Downstream)

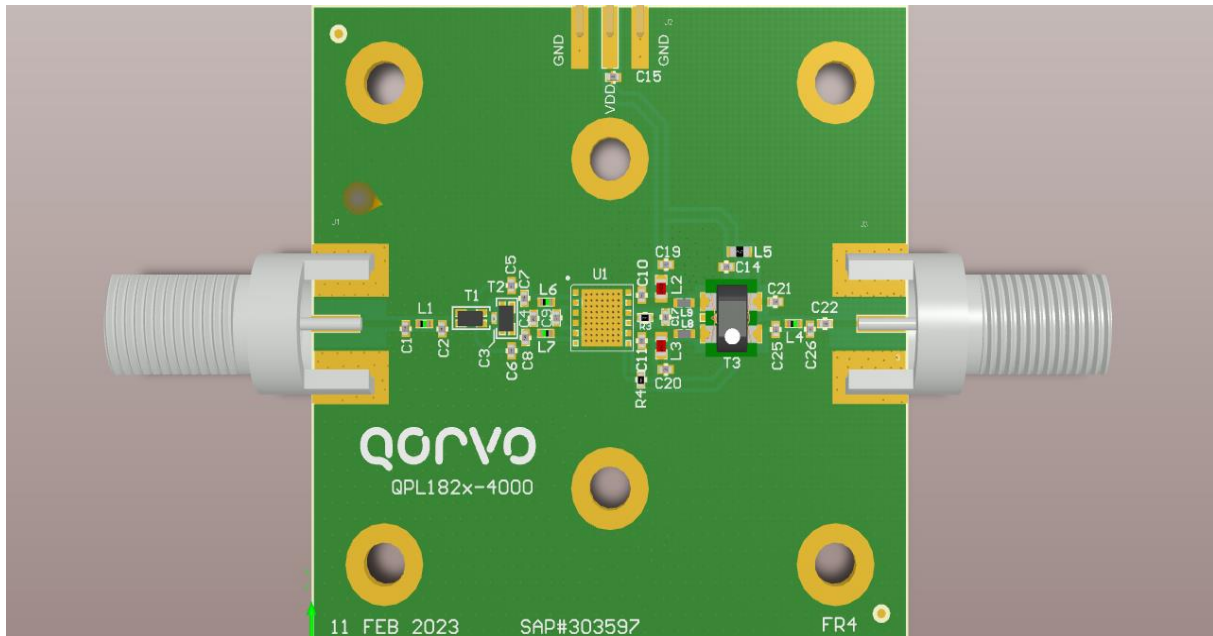

**Materials:** Isola370HR High-Tg FR4

Layer	Thickness	Primary Stack	Description	Dk / Df
Layer - 1	0.0010 0.0020		Taiyo 4000-HFX DI 1/2oz Mix (Std Plt)	3.50 / 0.0190
Layer - 2	0.0578 0.0020		370H 1/2oz Mix (Std Plt)	4.34 / 0.0180

### Evaluation Board Bill of Materials for Downstream 5V



Ref. Designator	Part Value	Manufacturer	Manufacturer Part #
U1	1800MHz, Ultra-Linear Amp	Qorvo	QPL1823
C1, C2, C5, C6	0.2pF	Murata	GJM1555C1HR20BB01D
C3	0.8pF	Murata	GJM0335C1ER80BB01D
L6, L7	1nF	Murata	GRM1555C1H102JA01D
C10, C11	1.0pF	Murata	GJM1555C1H1R0BB01D
C22	220pF	Kyocera	04025A221JAT2A
C14, C19, C20, C21	0.01uF	Murata	GCM155R71H103KA55D
C15	0.1uF	Murata	GRM155R71E104KE14D
L1, L8, L9	1.6nH	Murata	LQW15AN1N6C80D
L2, L3	1.5k FB	Murata	BLM18HE152SN1D
L4	2.2nH	Murata	LQW15AN2N2B80D
C7, C8	1.8nH	Murata	LQW15AN1N8C00D
R3	3.0kΩ	Kamaya	RMC1/16S-302JTH
R4	1.1kΩ	Kamaya	RMC1/16S-112JTH
T1, T2	1:1 Balun	Murata	DXW21BN7511SL07
T3	1:1 Balun	Mini-Circuits	TRS1-182-75-7+
J1, J4	CONN, F	Millimeter Wave	MW-846-C-DD-75
J2, J3	CONN, 3-PIN, 0.100"	Samtec	TSW-103-07-G-S
C4, C9, C17, C25, C26, L5	Not Populated Item	-	-
PCB	303597	Qorvo	QPL182x-4000
Heatsink	Heatsink 50mm x 50mm	Alpha Novatek	S08EFV05-A

## BOM Changes for Downstream 8V Operation

R4	RES, 1.8K OHM, 1%, 1/10W, 0402	Panasonic	ERJ-2RKF1801X
----	--------------------------------	-----------	---------------

## Electrical Specifications (Upstream)



Parameter	Condition (1)	Min	Typ	Max	Unit
Supply Voltage (VDD)			5/8		V
Supply Current (IDD)			260/350		mA
Frequency Range		5		700	MHz
Gain at 5 MHz			23		dB
Gain at 700 MHz			23.5		dB
Gain Slope			0.5		dB
Reverse Isolation			27		dB
Input Return Loss	5 – 700MHz		-20		dB
Output Return Loss	5 – 700MHz		-20		dB
MER	At +65dBmV @ 5V and +69dBmV @ 8V Total Composite Output power. 5MHz to 700MHz, 112 Ch, SC-QAM, 0dB tilt, 0dB Offset (Source corrected)		45		dB
Noise Figure	5-700MHz		2.5		dB
OIP2L	+12 dBm / tone output, $\Delta f=53$ MHz, Full Band		90		dBm
OIP2U	+12 dBm / tone output, $\Delta f=53$ MHz, Full Band		80		dBm
OIP3	+12 dBm / tone output, $\Delta f=6$ MHz, Full Band		43/46		dBm
OP1dB	5-700MHz		28/31		dBm
Thermal Resistance	$\Theta_{JC}$ (Junction to Device Heat Slug)		12		$^{\circ}\text{C/W}$

Note: Typical performance at these conditions: Temp = +25  $^{\circ}\text{C}$ ,  $V_{DD}$  = +5 V, 75  $\Omega$  system, Full band unless otherwise noted

### Evaluation Board Schematic 5 MHz – 700 MHz (Upstream)

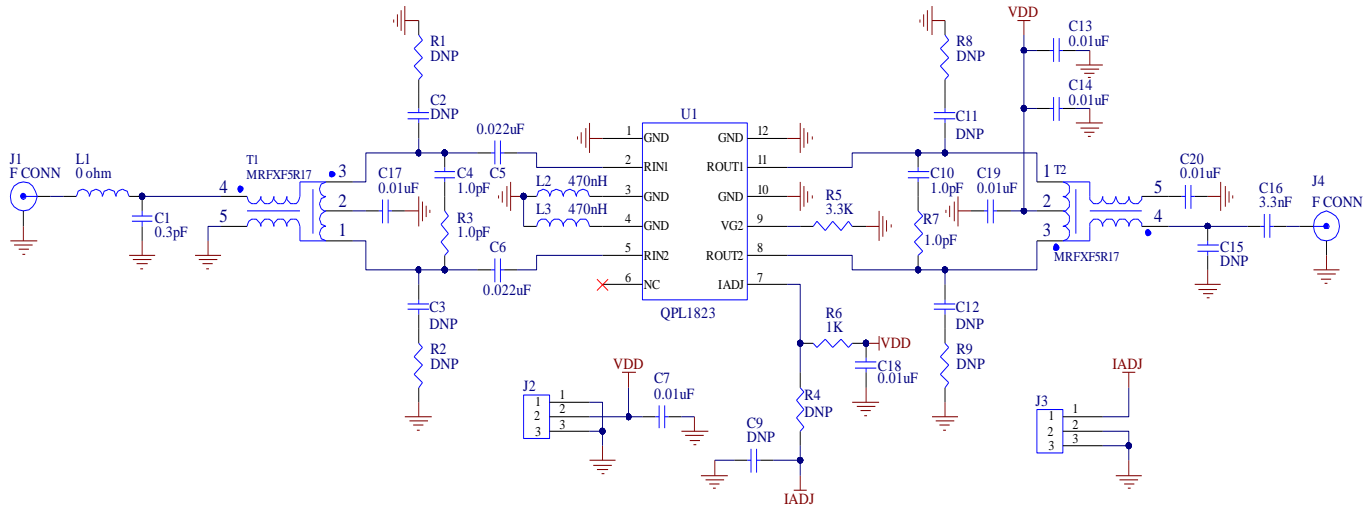

### Evaluation Board Assembly Drawing (Upstream)

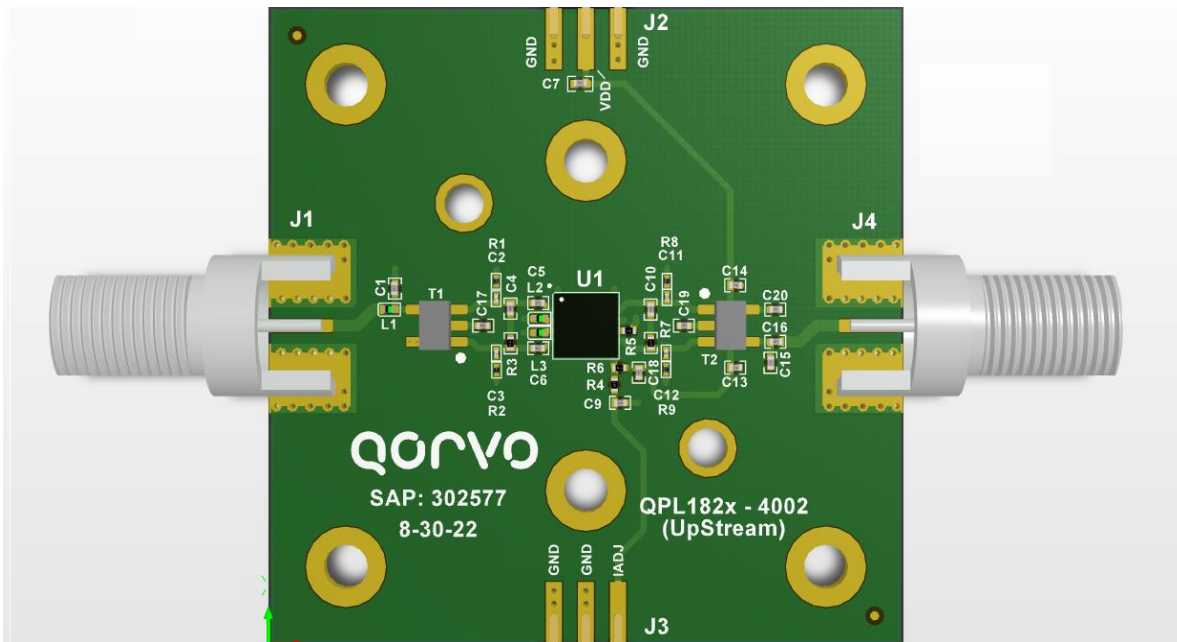

**Materials:** Isola370HR High-Tg FR4

Layer	Thickness	Primary Stack	Description	Dk / Df
Layer - 1	0.0010		Taiyo 4000-HFX DI 1/2oz Mix (Std Plt)	3.50 / 0.0190
	0.0020			4.34 / 0.0180
Layer - 2	0.0578		370H 1/2oz Mix (Std Plt)	
	0.0020			



Evaluation Board Bill of Materials for Upstream 5V

Ref. Designator	Part Value	Manufacturer	Manufacturer Part #
U1	1.8GHz 5V, Push Pull, 25dB gain	Qorvo	QPL1823
C1	CAP, 0.3pF, +/-0.05pF, 50V, HI-Q, 0402	MURATA	GJM1555C1HR30WB01D
C7,C13,C14,C17, C18,C19,C20	CAP, 0.01uF, 10%, 50V, X7R, 0402	MURATA	GCM155R71H103KA55D
C4,C10,R3,R7	CAP, 1pF, +/-0.05pF, 50V, HI-Q, 0402	MURATA	GJM1555C1H1R0WB01D
C5,C6	CAP, 0.022uF, 10%, 50V, X7R, 0402	MURATA	GCM155R71H223KA55D
C16	CAP, 3300pF, 10%, 50V, X7R, 0402	Kemet	C0402C332K5RACTU
L1	RES, 0 OHM, 5%, 1/10W, 0402	Kamaya, Inc	RMC1/16SJPTH
R6	RES, 680 OHM, 5%, 1/16W, 0402	Kamaya, Inc	RMC1/16S-681JTH
R5	RES, 3.3K, 5%, 1/16W, 0402	Kamaya, Inc	RMC1/16S-332JTH
L2,L3	IND, 470nH, 5%, 310mA, W/W, 0402	Coilcraft, Inc.	0402AF-471XJLU
T1,T2	BALUN, 1:1, 5-700MHz, 75 OHM	Mini-RF, Inc.	MRFXF5R17
J2,J3	CONN, HDR, ST, 3-PIN, 0.1"	SAMTEC INC.	TSW-103-07-G-S
J1,J4	CONN, F 75 OHMS, 0.068"	Millimeter Wave	MW-846-C-DD-75
C2,C3,C9,C11,C12, C15,R1,R2,R4,R8,R9	NOT POPULATED ITEM		
PCB	PCB, QPL1820	Qorvo	QPL1820-4002(A)
Heat Sink	50 x 50 x10, ALUMINUM	Alpha Nova Tech Inc	S08EFV05-A

BOM Changes for Upstream 8V Operation

R6	RES, 1.2K OHM, 1%, 1/10W, 0402	Panasonic	ERJ-2RKF1201X
----	--------------------------------	-----------	---------------

Performance Data, Downstream 5V

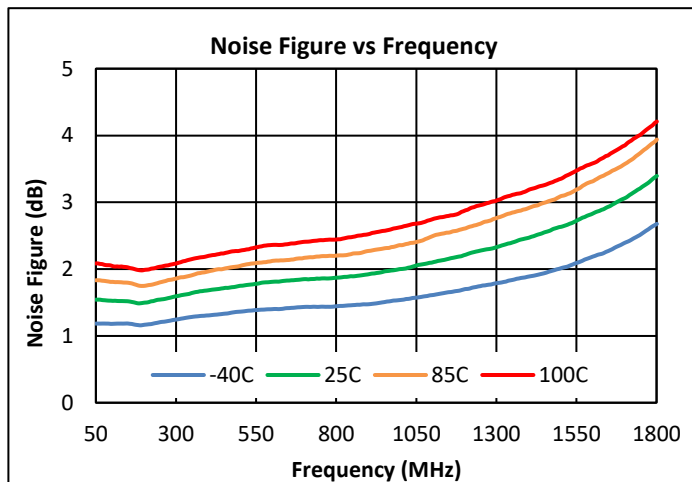
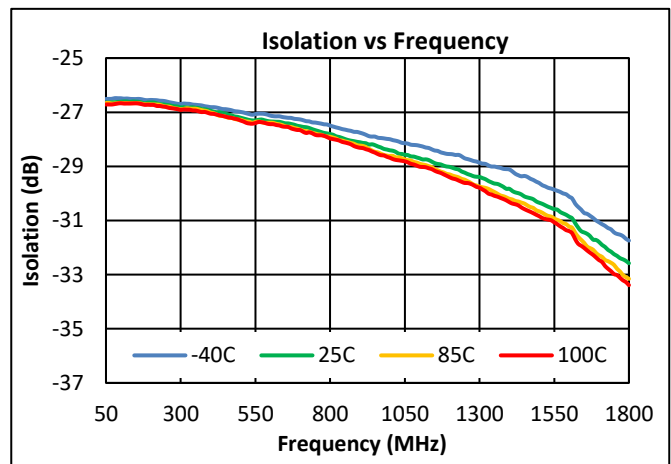
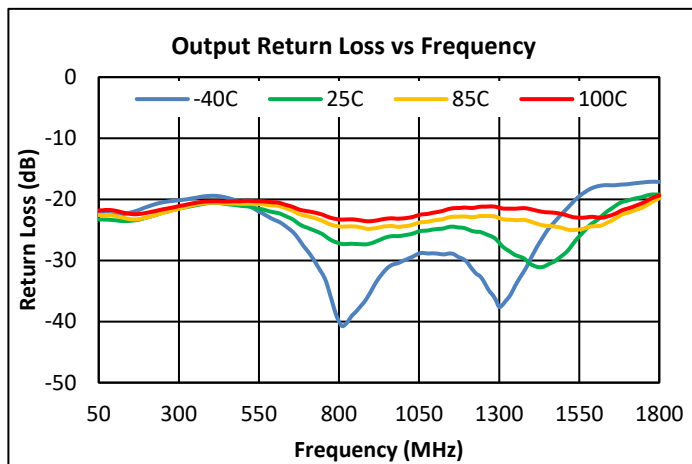
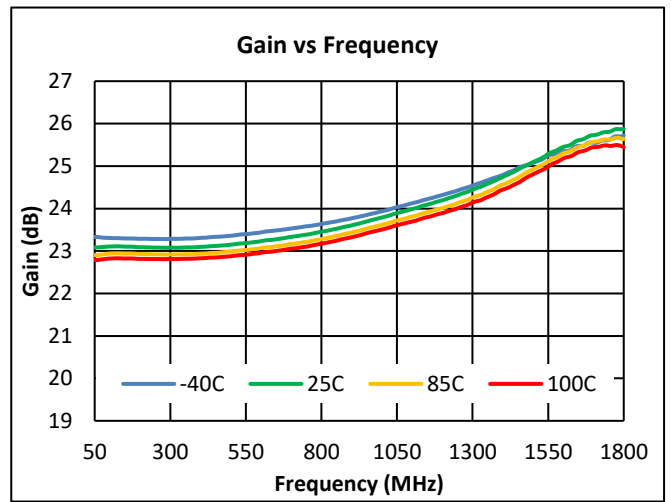
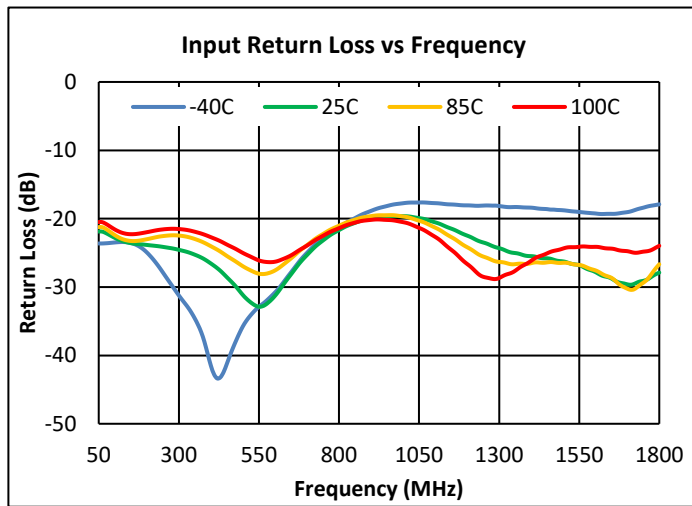



Performance Data, Downstream 5V (cont'd)

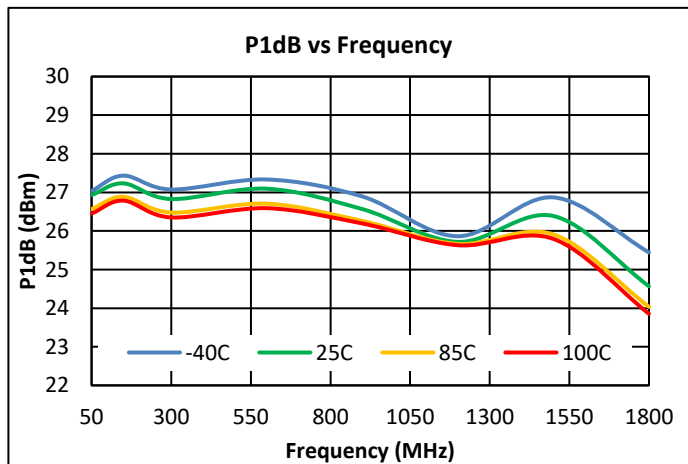
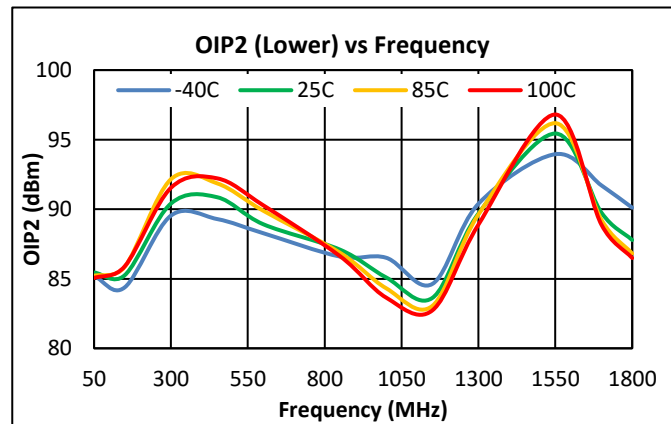
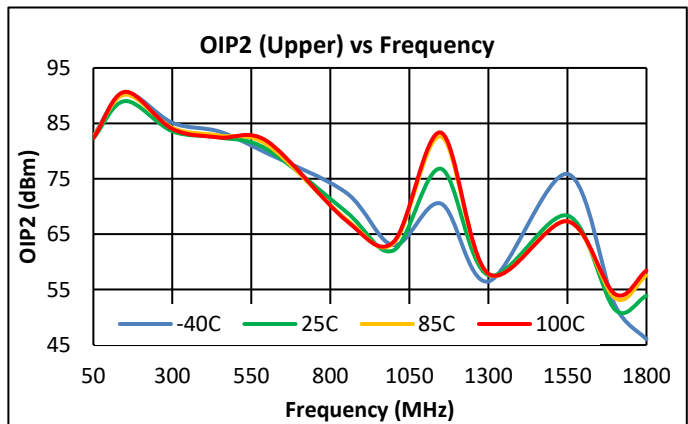
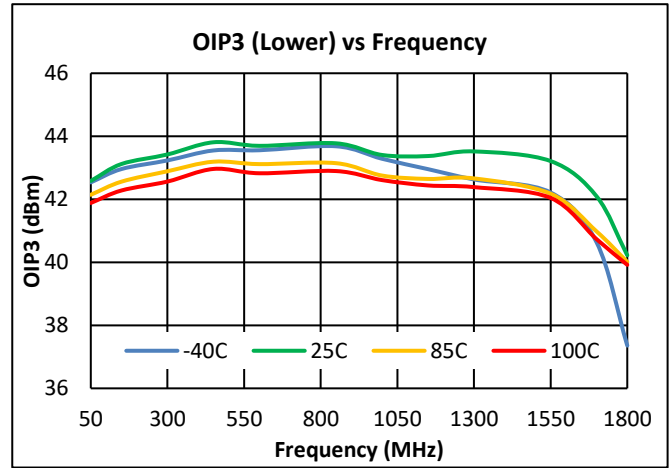
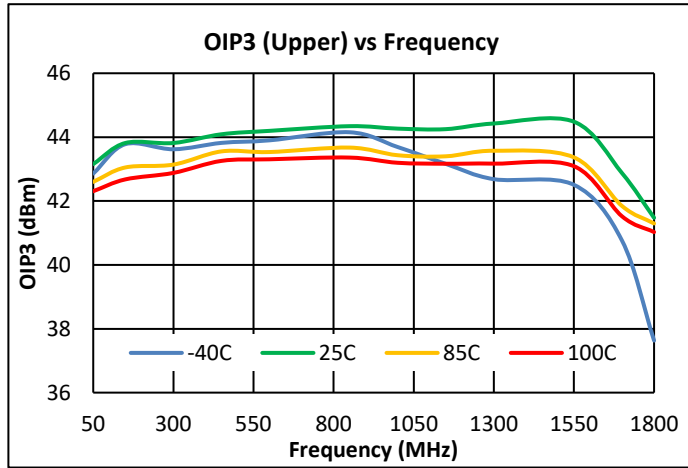

Notes:

- (1) 5V OIP3: +12dBm / tone output @  $\Delta f = 6\text{MHz}$
- (2) 5V OIP2: +12dBm / tone output @  $\Delta f = 53\text{MHz}$

### Performance Data, Downstream 5V (cont'd)

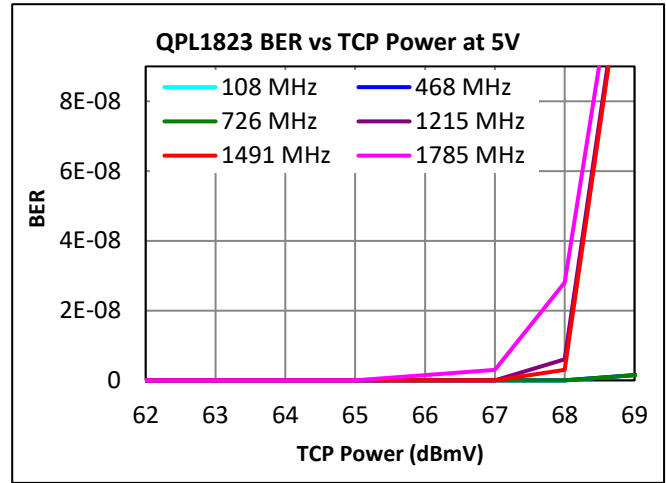
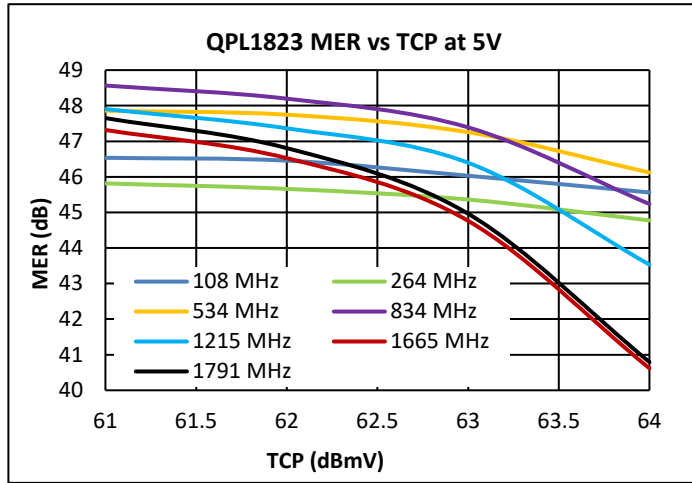

**Notes:**

- (1) MER & BER Test Conditions: (108 – 1791 MHz, 280 Ch SC-QAM, 10dB tilt, 0dB offset)
- (2) MER is uncorrected

Performance Data, Downstream 8V

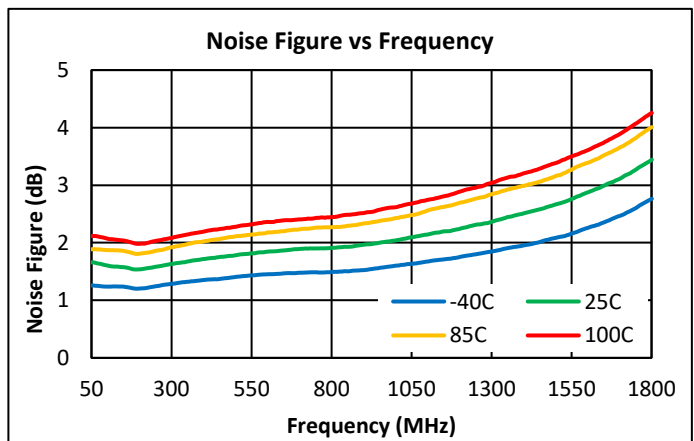
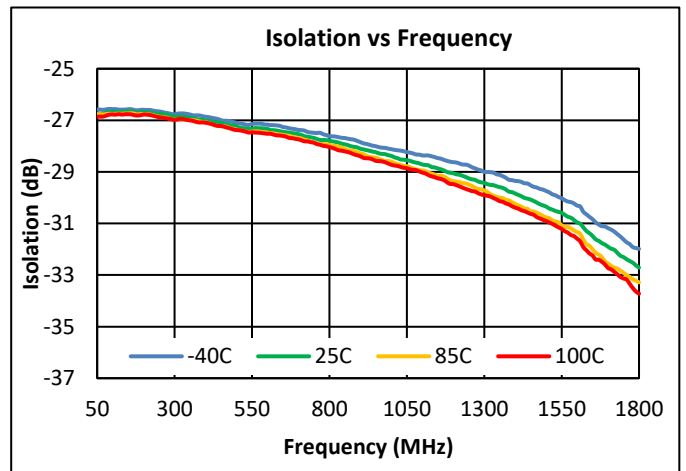
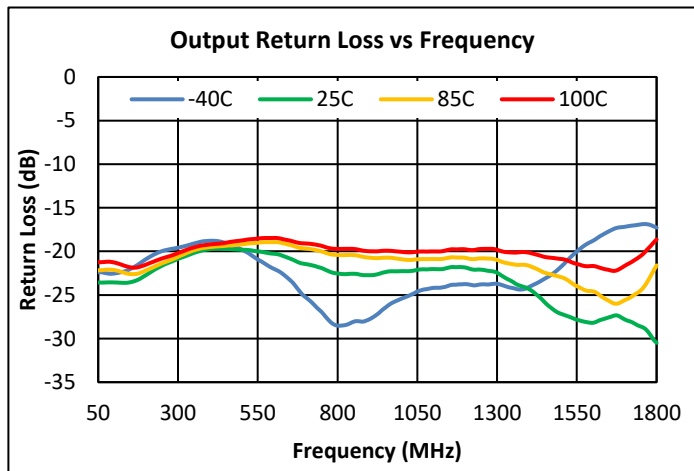
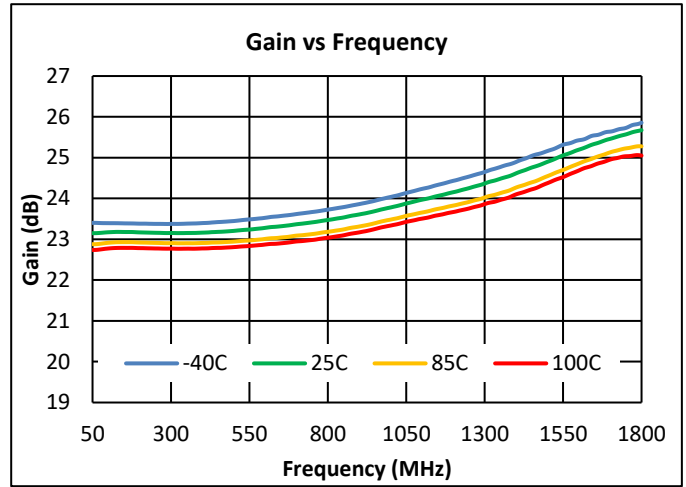
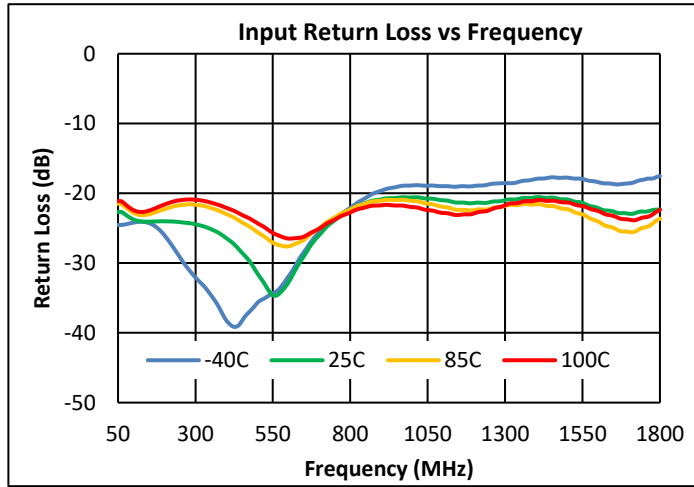

**Performance Data, Downstream 8V (Cont'd)**

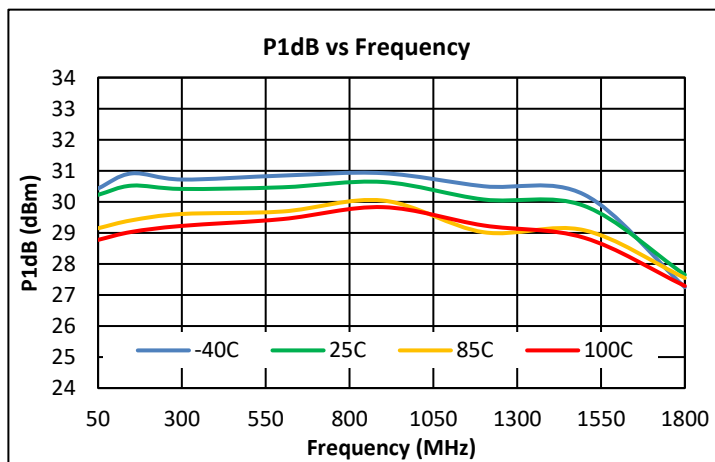
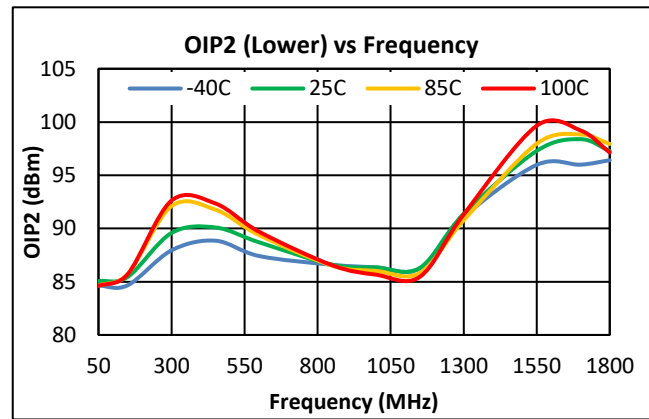
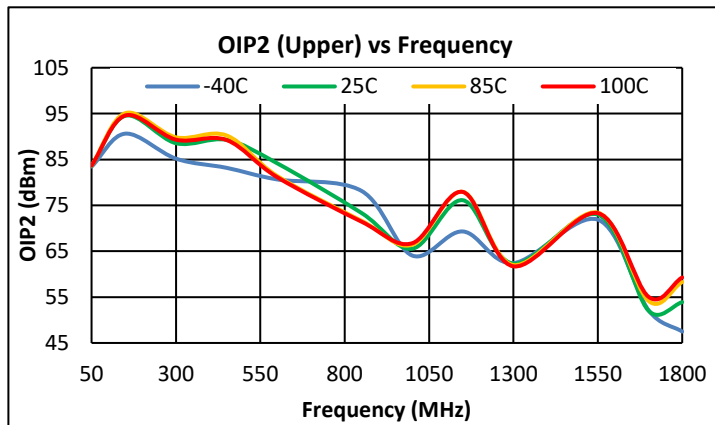
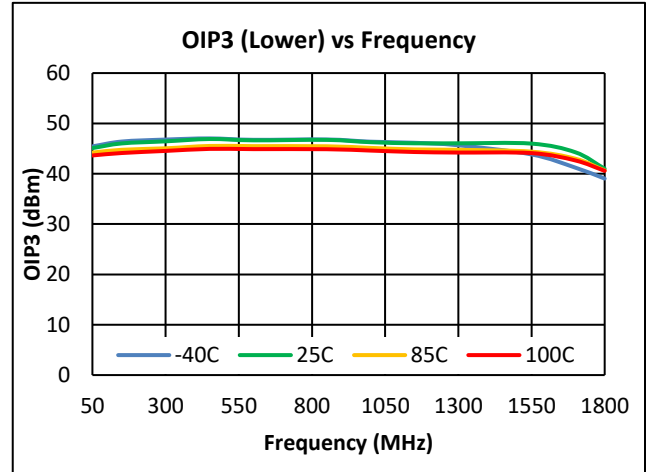
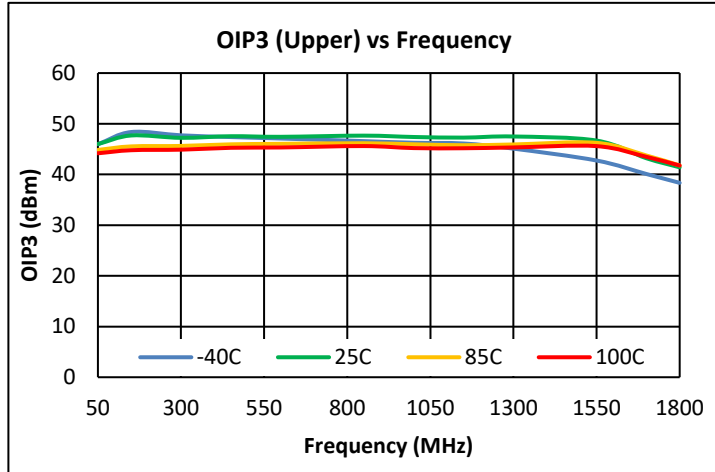

- Notes:
- (1) 8V OIP3: +15dBm/ tone output @  $\Delta f = 6\text{MHz}$
  - (2) 8V OIP2: +15dBm/ tone output @  $\Delta f = 53\text{MHz}$

### Performance Data, Downstream 8V (Cont'd)

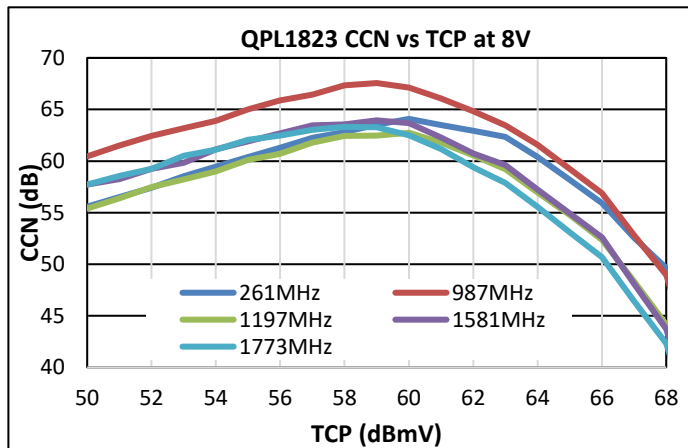
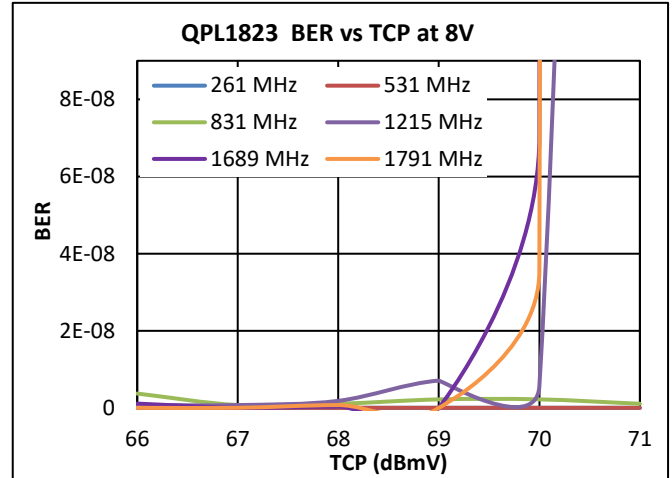
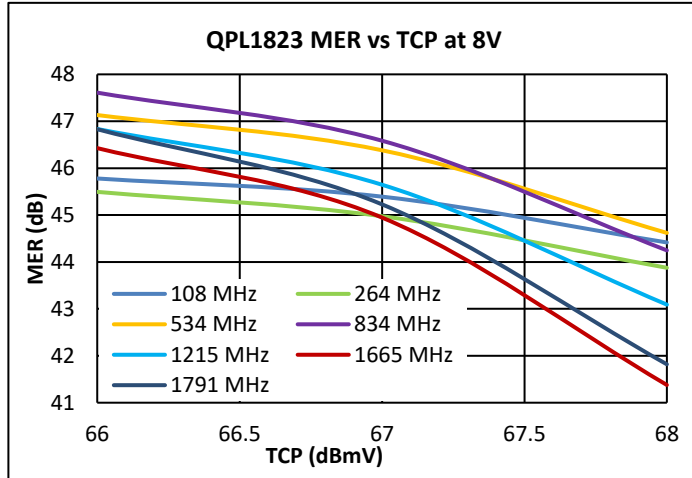

**Notes:**

- (1) MER & BER Test Conditions: (108 – 1791 MHz, 280 Ch SC-QAM, 10dB tilt, 0dB offset)
- (2) MER is uncorrected
- (3) CCN Test conditions: 10dB tilt, 6dB offset at 1.026GHz, 261-1791MHz loading

Performance Data, Upstream 5V

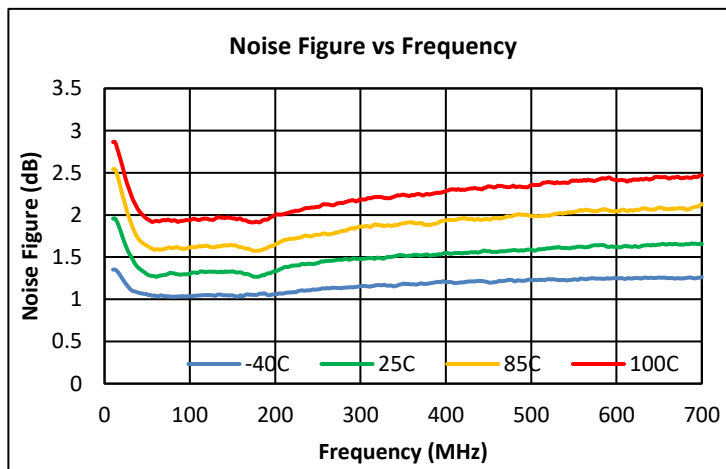
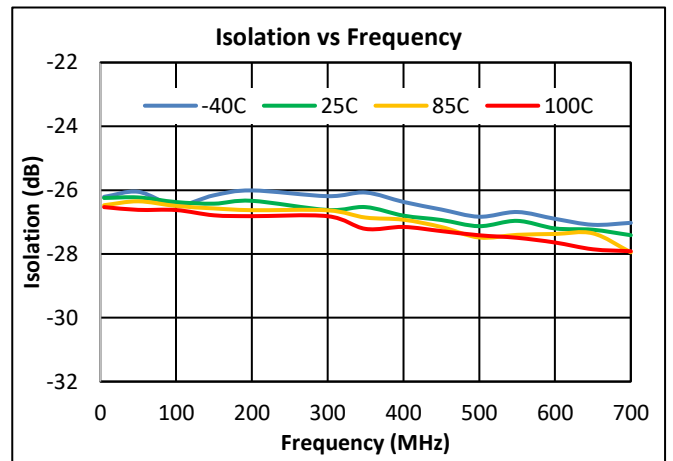
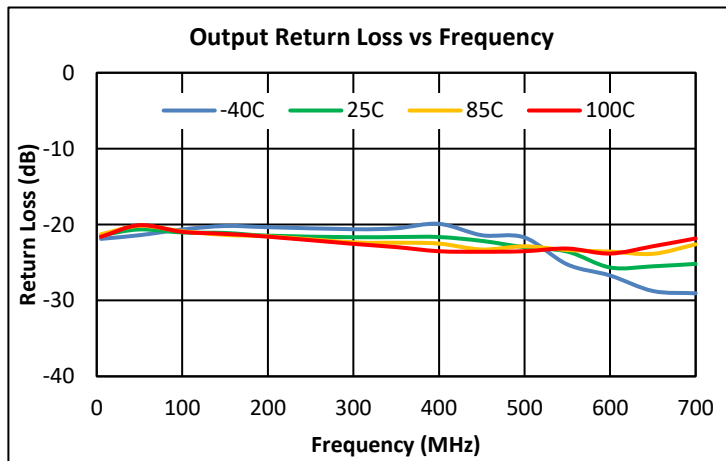
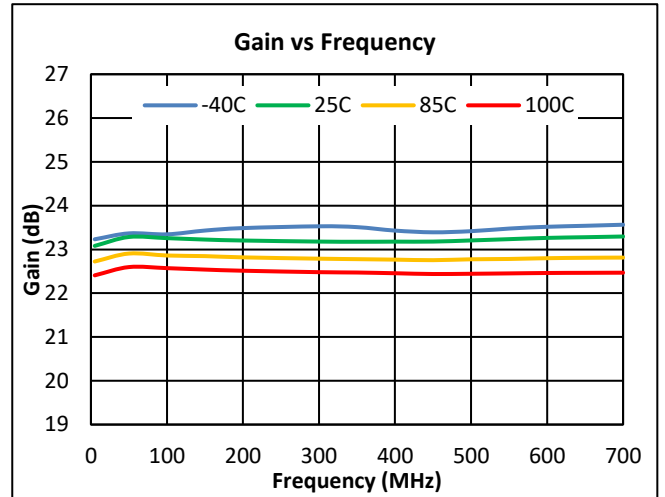
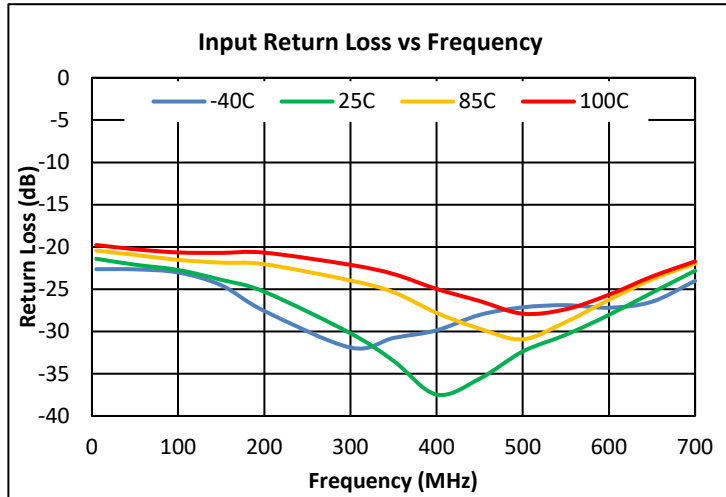

**Performance Data, Upstream 5V (Cont'd)**

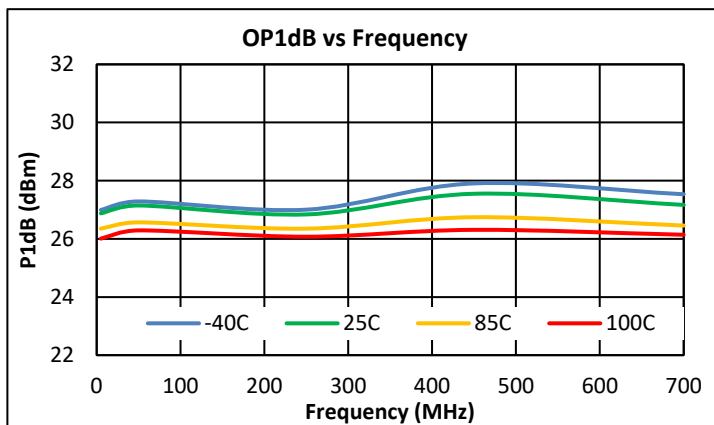
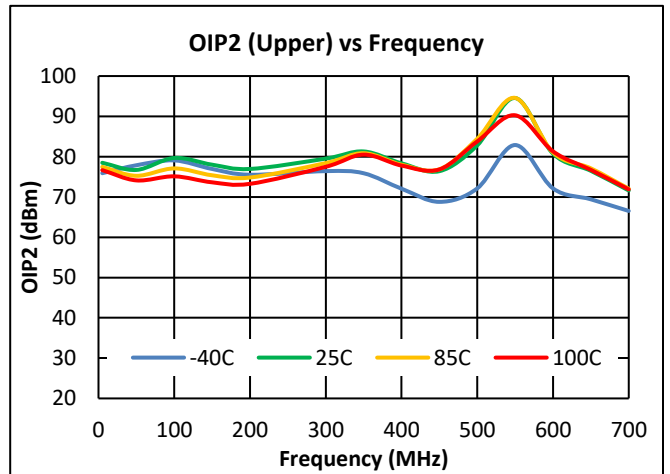
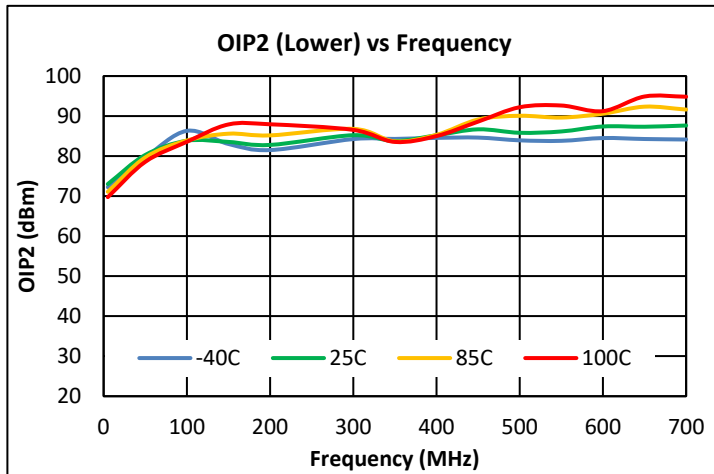
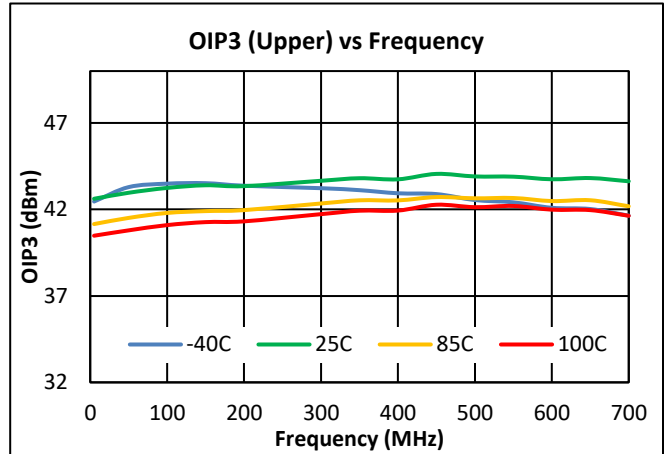
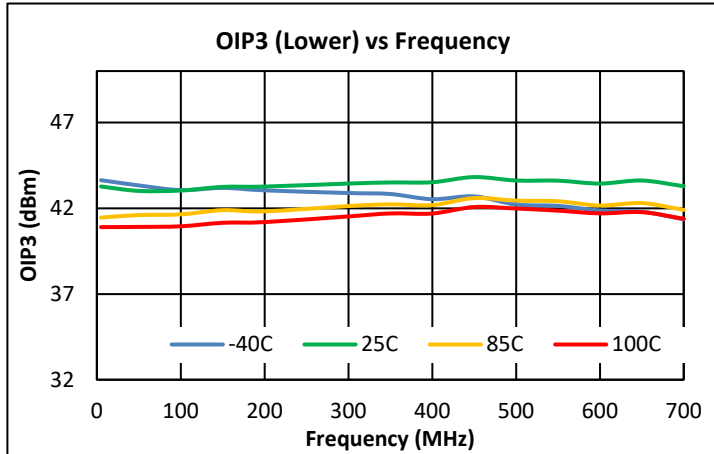

- Notes:
- (1) 5V OIP3: +12dBm / tone output @ Δf = 6MHz
  - (2) 5V OIP2: +12dBm / tone output @ Δf = 53MHz

### Performance Data, Upstream 5V (Cont'd)

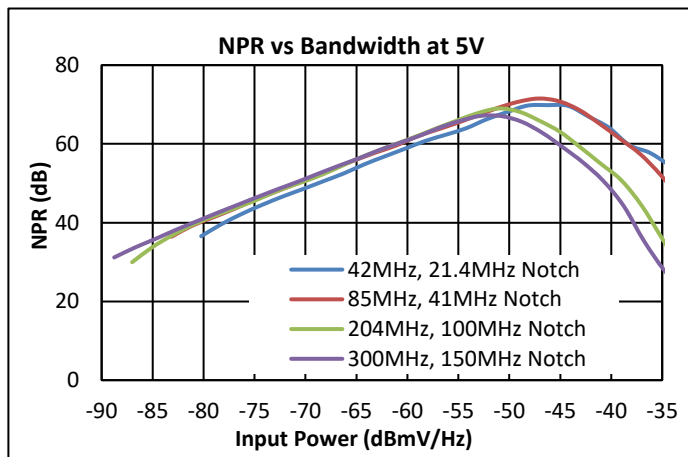
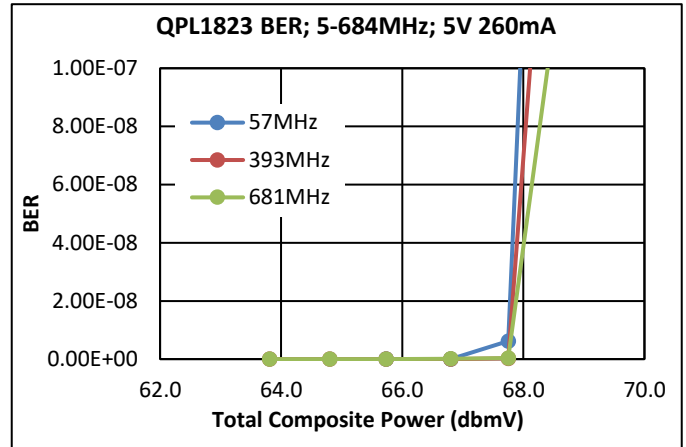
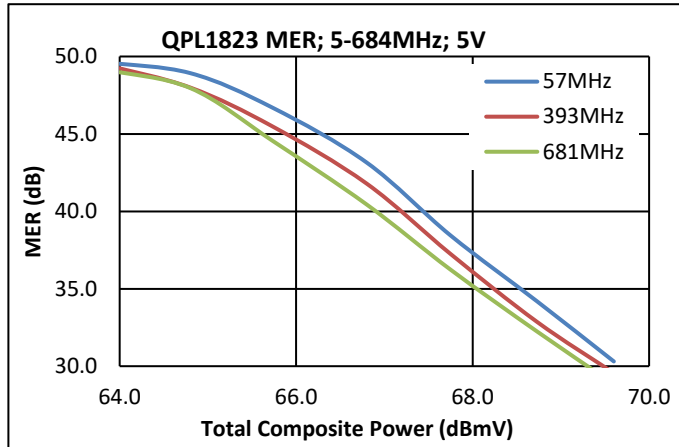

**Notes:**

- (1) MER & BER Test Conditions: (5 – 694 MHz, 111 Ch SC-QAM, 0dB tilt)
- (2) MER is corrected



**Performance Data, Upstream 8V**

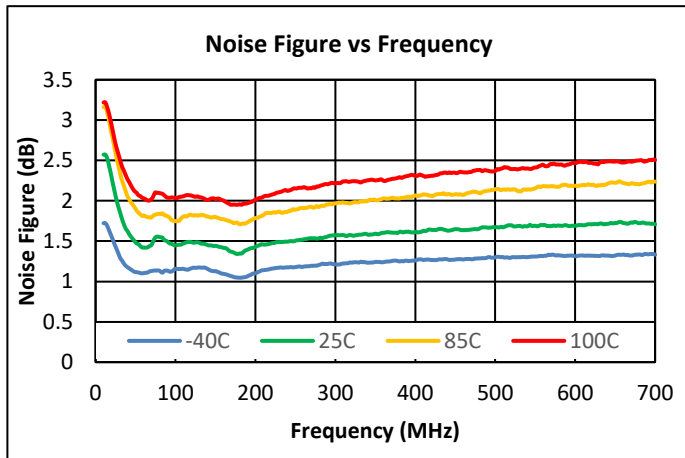
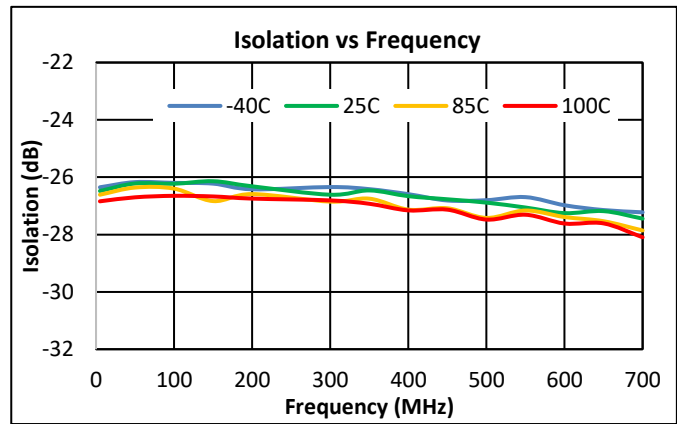
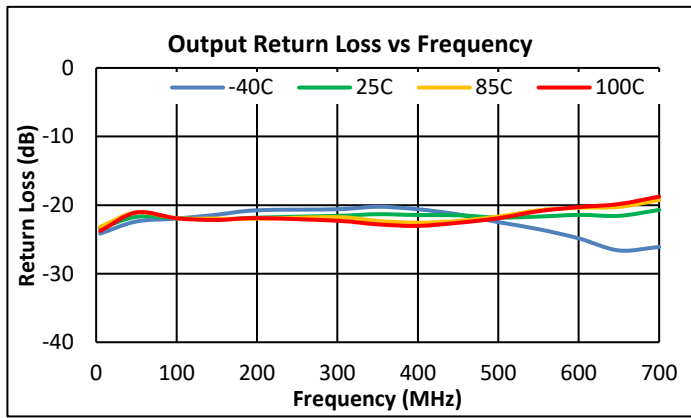
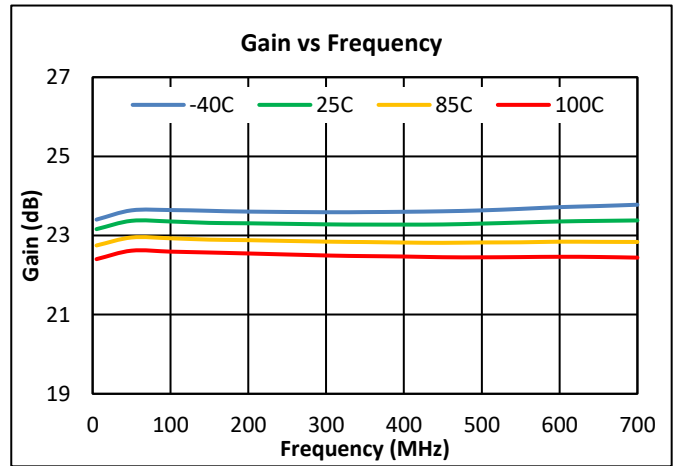
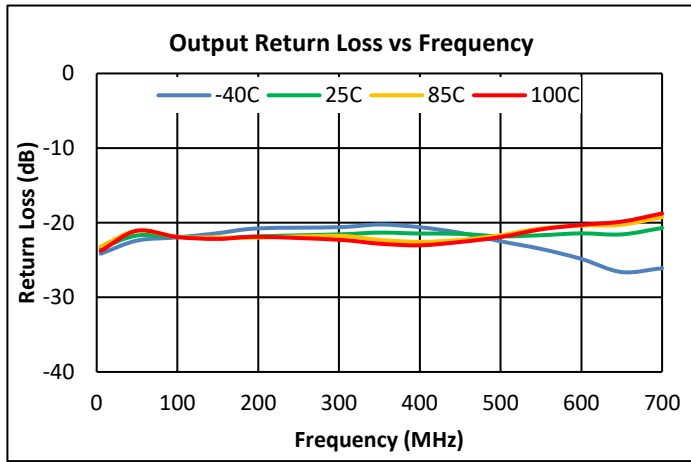

**Performance Data, Upstream 8V (Cont'd)**

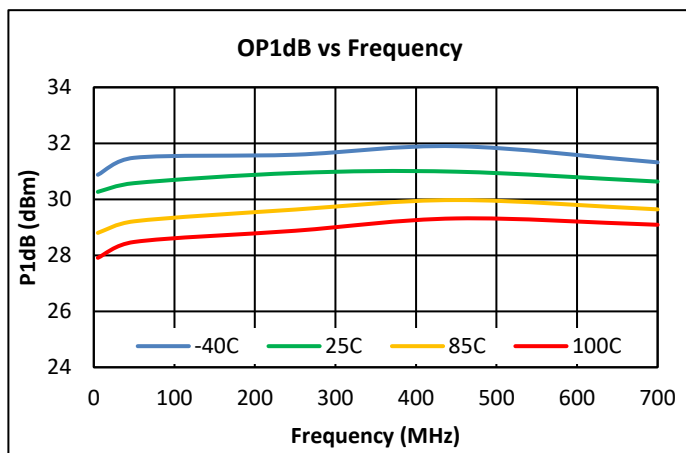
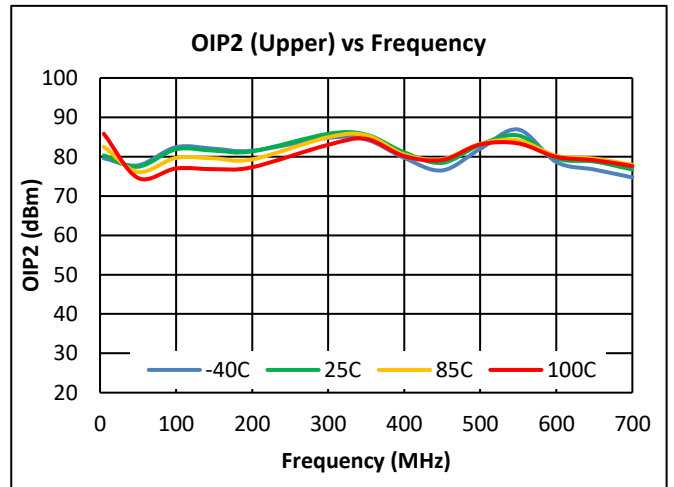
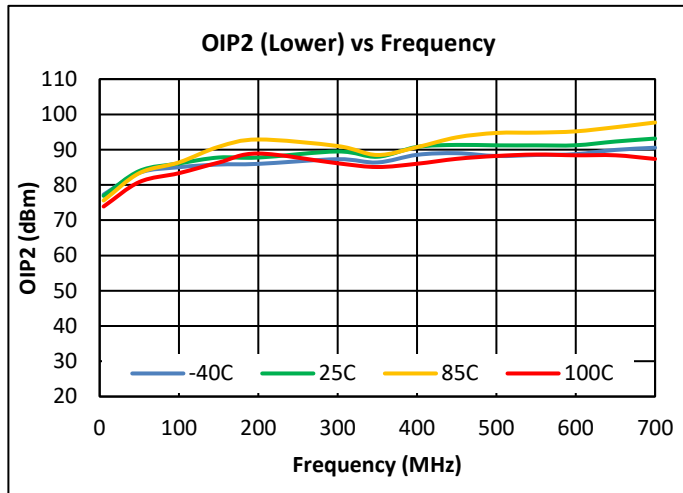
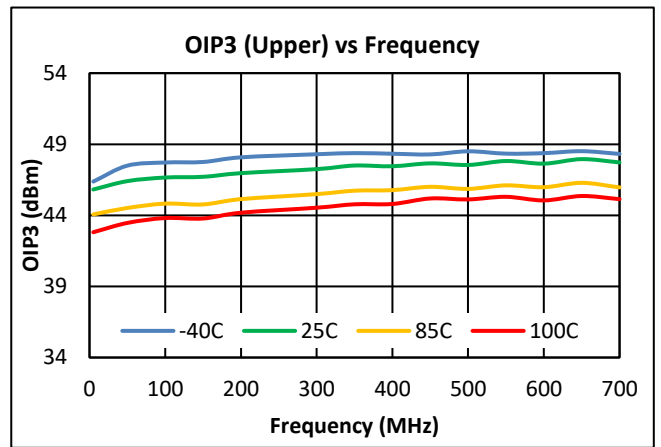
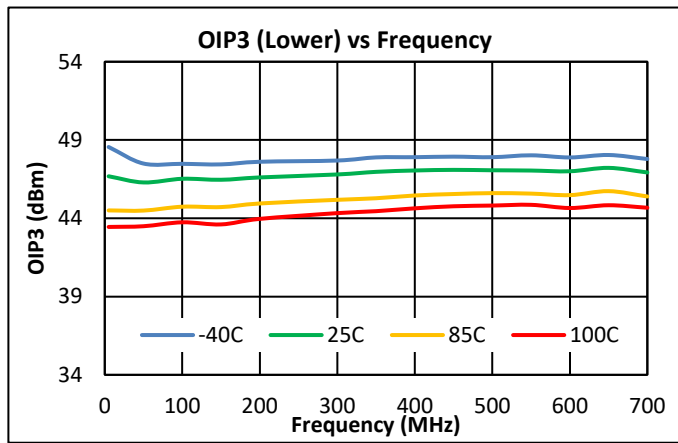

**Notes:**

- (1) 8V OIP3: +15dBm /tone output @  $\Delta f = 6\text{MHz}$
- (2) 8V OIP2: +15dBm/tone output @  $\Delta f = 53\text{MHz}$

### Performance Data, Upstream 8V (Cont'd)

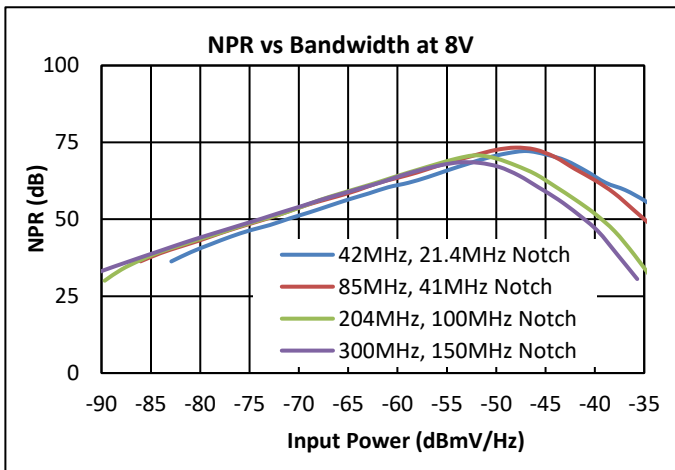
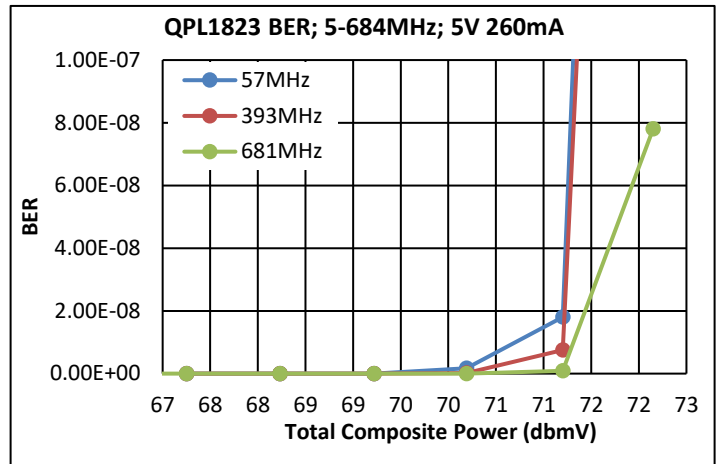
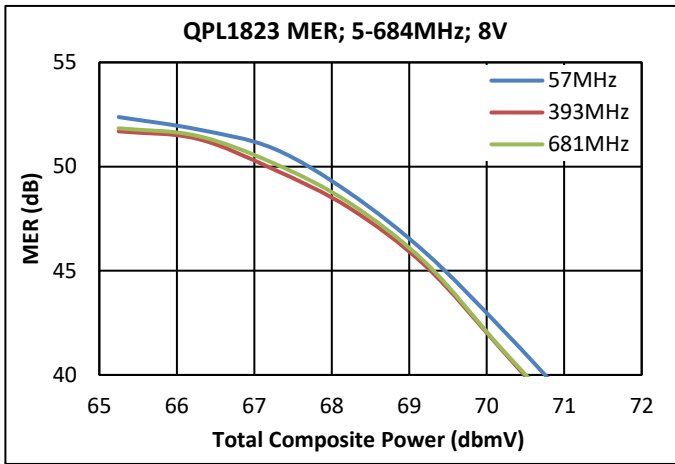

**Notes:**

- (1) MER & BER Test Conditions: (5 – 694 MHz, 111 Ch SC-QAM, 0dB tilt)
- (2) MER is corrected

IADJ Resistor Value

The Resistor Rbias is used to set the device current. In the application circuit, the value of Rbias is set to get an IDD of 260mA which is optimal for linearity at 5V. In applications where higher linearity is required, or higher supply rail is present, the IDD can be adjusted by varying the value of Rbias. (See graph below for downstream application)

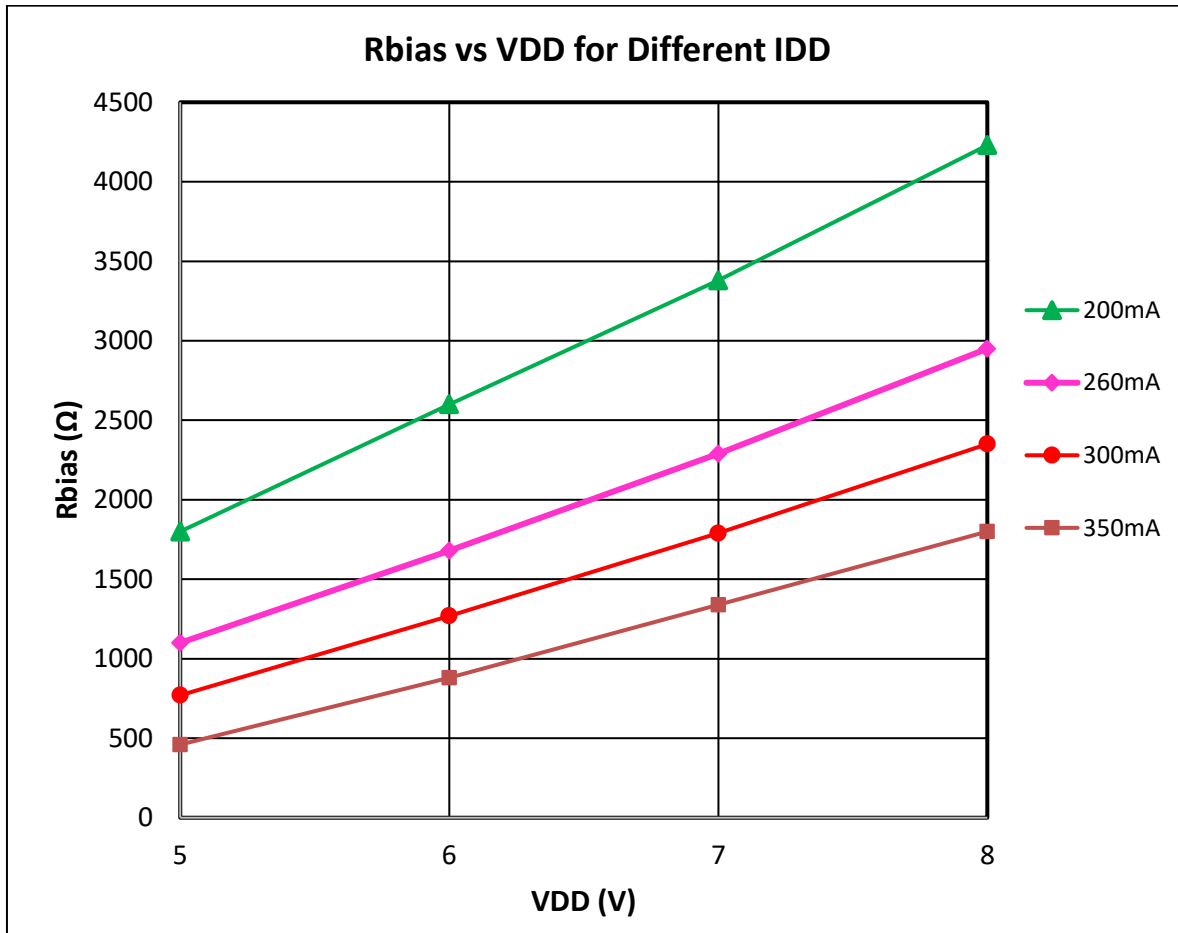

## Pin Configuration and Description

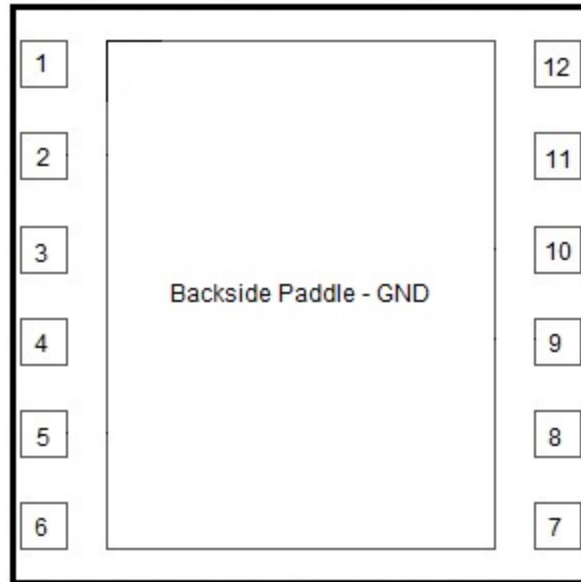

**5 x 5 12-pin Laminate MCM**

Pin Number	Label	Description
1	NC	No internal connection, recommend connecting to EVB GND
2	RFIN+	RF Input +
3	GND	Must be connected to EVB GND
4	GND	Must be connected to EVB GND
5	RFIN-	RF input -
6	NC	No connect pin. Leave it open. Do not connect to GND.
7	IADJ	IDD current set
8	RFOUT-/VDD2	RF output - and VDD through RF Choke
9	VG2	Cascode device bias resistor divider
10	NC	No internal connection, recommend connecting to EVB GND
11	RFOUT+/VDD	RF output + and VDD through RF Choke
12	NC	No internal connection, recommend connecting to EVB GND
Paddle	GND	DC/RF/Thermal/GND. (Maximize vias in this area)

### Package Outline

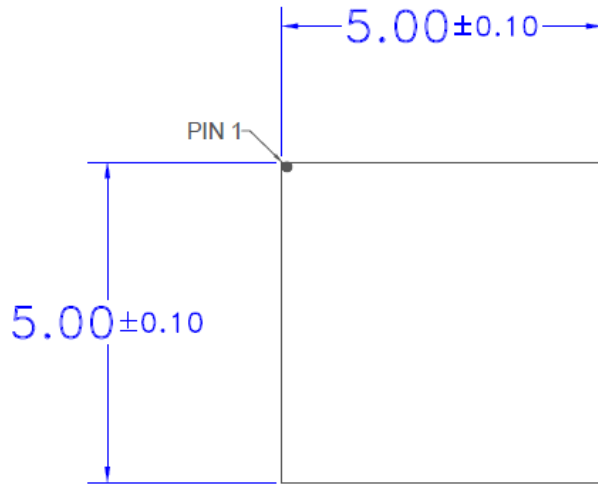

TOP VIEW

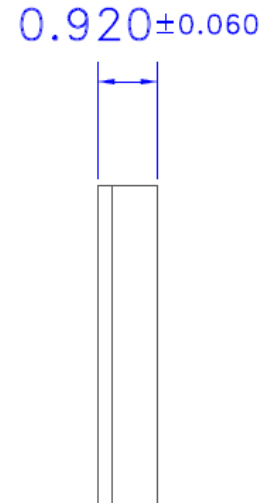

SIDE VIEW

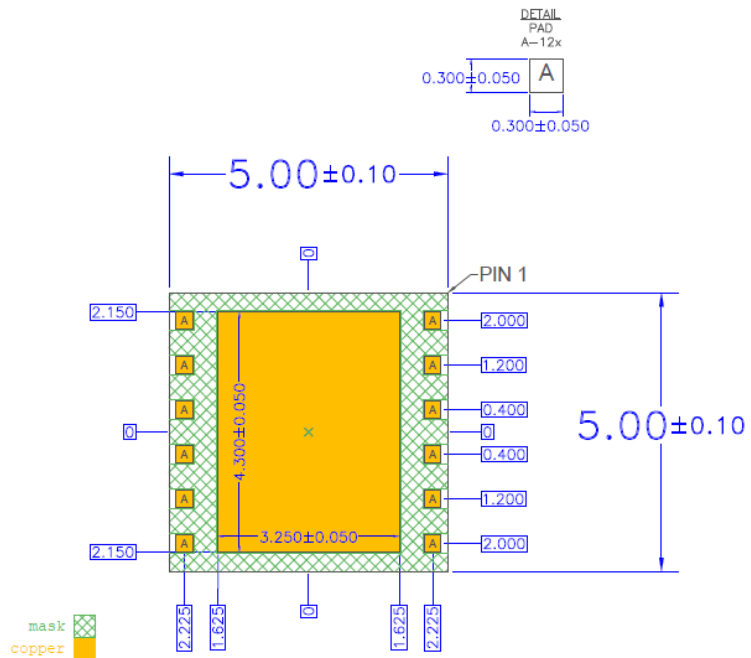

BOTTOM VIEW

Package Marking

---

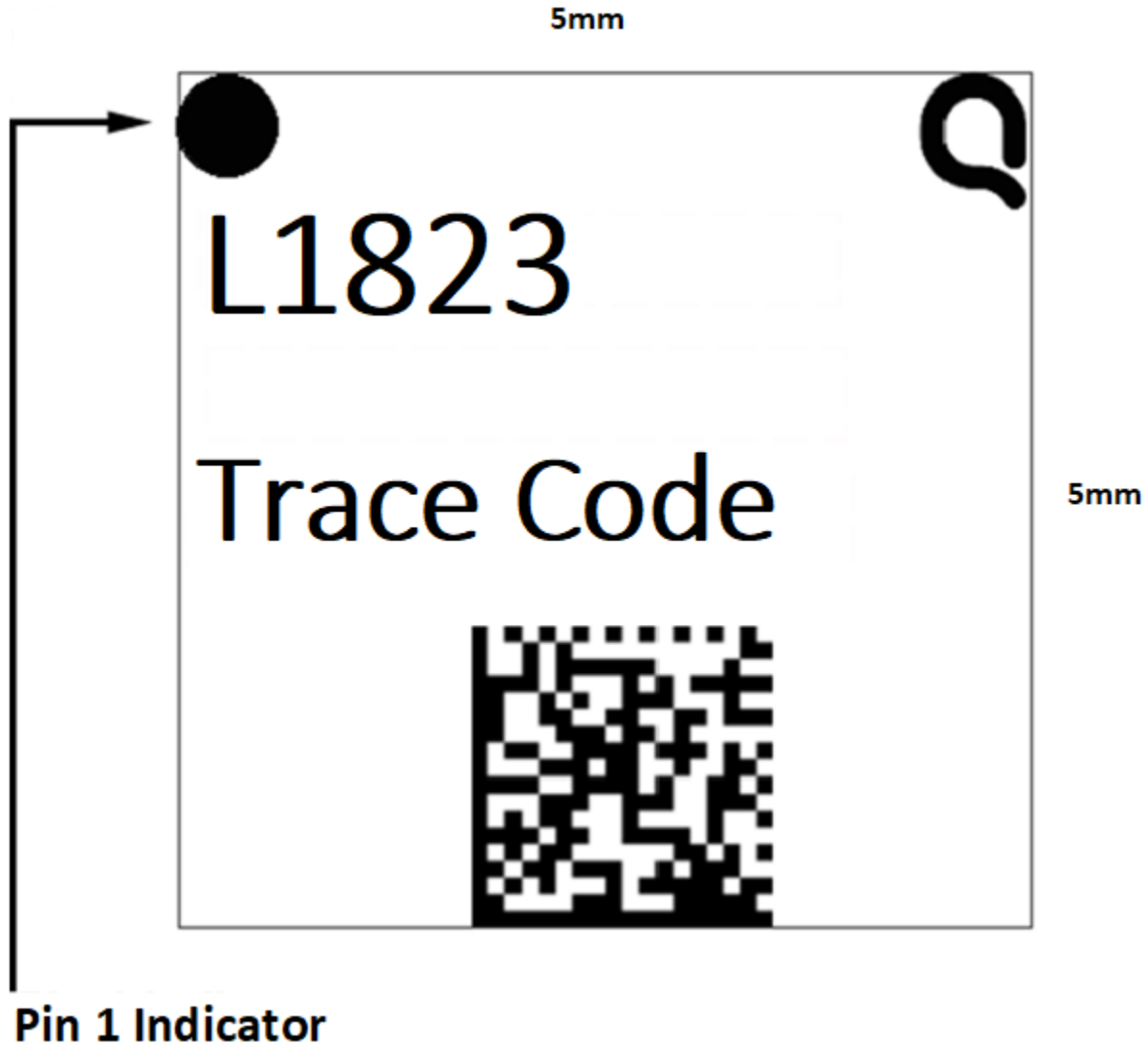

## Handling Precautions

Parameter	Rating	Standard
ESD – Human Body Model (HBM)	Class 1B (500V to <1000V)	ANSI / ESDA / JEDEC JS-001
ESD – Charged Device Model (CDM)	Class C3 ( $\geq 1000V$ )	ANSI / ESDA / JEDEC JS-002
MSL – Moisture Sensitivity Level	MSL3	IPC / JEDEC J-STD-020



Caution!  
ESD-Sensitive Device

## Solderability

Compatible with both lead-free (260 °C max. reflow temp.) and tin / lead (245 °C max. reflow temp.) soldering processes.  
Solder profiles available upon request.

Contact plating: ENEPIG

## RoHS Compliance

This part is compliant with 2011/65/EU RoHS directive (Restrictions on the Use of Certain Hazardous Substances in Electrical and Electronic Equipment) as amended by Directive 2015/863/EU.

This product also has the following attributes:

- PFOS Free
- Halogen Free (Chlorine, Bromine)
- Antimony Free
- TBBP-A (C<sub>15</sub>H<sub>12</sub>Br<sub>4</sub>O<sub>2</sub>) Free
- SVHC Free

## Contact Information

For the latest specifications, additional product information, worldwide sales and distribution locations:

**Tel: 1-844-890-8163**

**Web: [www.qorvo.com](http://www.qorvo.com)**

**Email: [customer.support@qorvo.com](mailto:customer.support@qorvo.com)**