

### Product Overview

The QPL8831 is an ultra-linear GaAs pHEMT 75-Ohm RF balanced amplifier IC with 5 – 1218 MHz operating bandwidth, featuring high linearity, high gain and low noise for use as a post amplifier in optical receivers or as a low noise balanced preamp. This IC uses a 5V supply for applications requiring lower power dissipation. Due to its wide operational bandwidth the QPL8831 can also be used as a downstream amp in DOCSIS 3.1 as well as an upstream amplifier for DOCSIS 3.1 or DOCSIS 4.0 applications.



8-Pin SOIC Package

### Functional Block Diagram

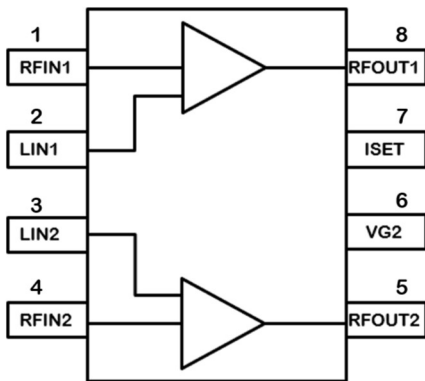

### Key Features

- High Gain: 17dB at 1218 MHz
- 5– 1218 MHz BW
- OIP3: +43 dBm, Downstream 50– 1218 MHz
- OP1dB: 24 dBm, Downstream 50– 1218 MHz
- Low Noise Figure: 4 dB, Full Band
- Excellent Composite Distortion
- pHEMT GaAs device technologies
- Compact Size: 8-pin SOIC
- Power Consumption (5 V, 280 mA, 1.4 W)

### Applications

- DOCSIS 3.1 Systems
- Balanced Antenna Applications
- HFC Optical Nodes
- 75 Ω Amplifiers
- Upstream Amplifier for DOCSIS 3.1 and DOCSIS 4.0 Applications

### Ordering Information

Part Number	Description
QPL8831SB	Sample bag with 5 pieces
QPL8831SR	7" Reel with 100 pieces
QPL8831TR13	13" Reel with 2500 pieces
QPL8831PCK-01	5– 1218 MHz PCBA with 5 pc sample bag

## Absolute Maximum Ratings

Parameter	Rating
Supply Voltage ( $V_{DD}$ )	+8 V
Supply Current ( $I_{DD}$ )	400 mA
Maximum Input Level (single tone)	+15 dBm
Operating Temperature Range	-40 to +85 °C
Storage Temperature Range	-40 to +150 °C
Maximum Junction Temperature	+150 °C

Exceeding any one or a combination of the Absolute Maximum Rating conditions may cause permanent damage to the device. Extended application of Absolute Maximum Rating conditions to the device may reduce device reliability.

## Electrical Specifications

Parameter	Condition <sup>(1)</sup>	Min	Typ	Max	Unit
Supply Voltage ( $V_{DD}$ )			5		V
Supply Current ( $I_{DD}$ )	$V_{DD}$ total current		280		mA
Frequency Range		5		1218	MHz
Gain	5 – 1218 MHz		17		dB
Gain Flatness	5 – 1218 MHz		±0.5		dB
Input Return Loss	5 – 1218 MHz		18		dB
Output Return Loss	5 – 1218 MHz		18		dB
Noise Figure	5 – 1218 MHz		4		dB
CSO	80 Ch NTSC + 111 QAM, flat tilt, 43dBmV / Ch downstream		-69		dBc
CTB			-71		dBc
CIN			63		dB
OIP2	13 dBm / tone, $\Delta f = 50$ MHz, 50-1218 MHz		70		dBm
OIP3	13 dBm / tone, $\Delta f = 6$ MHz, 50-1218 MHz		43		dBm
OIP2	13 dBm / tone, $\Delta f = 50$ MHz, 5-700 MHz		71		dBm
OIP3	13 dBm / tone, $\Delta f = 6$ MHz, 5-700 MHz		45		dBm
Output P1dB	50 – 1218 MHz		24		dBm
Output P1dB	5 – 700 MHz		25		dBm
Thermal Resistance			13		°C/W

### Notes:

1. Typical performance at these conditions: Temp = +25 °C,  $V_{DD} = +5$  V, 75 Ω system, Full band unless otherwise noted.
2. Downstream (Forward Path) Freq Range is 50-1218 MHz.
3. Upstream (Return Path) Freq Range is 5-700 MHz.

### Evaluation Board Schematic

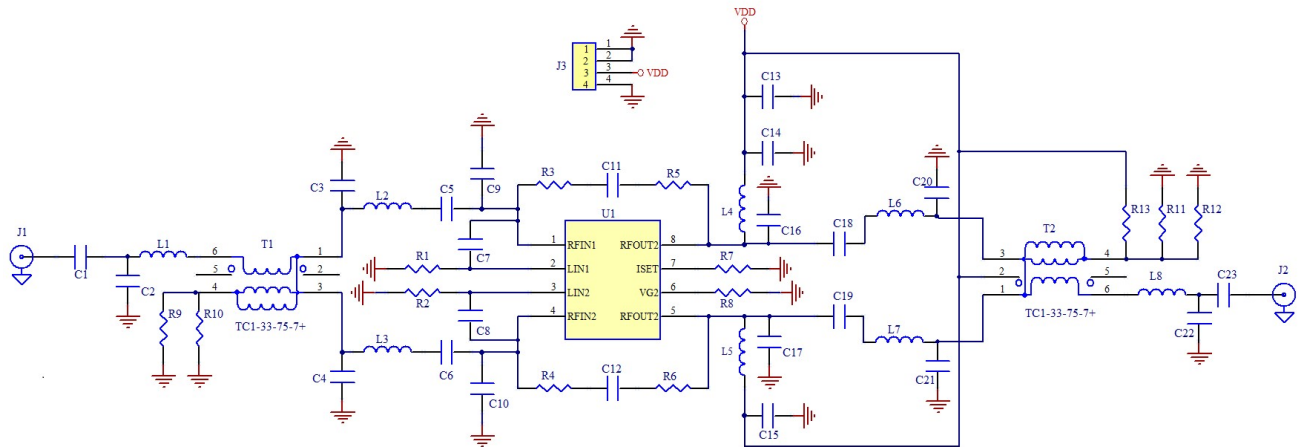

### Bill of Material for Evaluation Board

Reference Designator	Description	Manufacturer	Part Number
U1	1218 MHz, 17 dB Push-Pull Amp	Qorvo	QPL8831SB
PCB	EVB PCB, QPL8831	Qorvo	QPL883x-4001
C22	CAP, 0.2 pF, +/-0.05 pF, 50 V, 0402	Johanson	500R07S0R2AV4T
C1, C5, C6, C7, C8, C11, C12, C13, C14, C15, C23	CAP, 0.01uF, 10 %, 50 V, 0402	Murata	GCM155R71H103KA55D
C18, C19	CAP, 270 pF, 5 %, 0402	Murata	GCM1555C1H271JA16D
R5, R6, R9, R11, L1, L2, L3, L6, L7	RES, 0 Ω, 0402	Kamaya	RMC1/16SJPTH
R7	RES, 1.5 KΩ, 5 %, 1/16 W, 0402	Kamaya	RMC1/16S-152JTH
R8	RES, 3.9 KΩ, 5 %, 1/16 W, 0402	Kamaya	RMC1/16S-392JTH
R3, R4	RES, 470 Ω, 5 %, 1/16 W, 0402	Kamaya	RMC1/16S-471JTH
R1, R2	RES, 1.2 KΩ, 5 %, 1/16 W, 0402	Kamaya	RMC1/16S-122JTH
L8	IND, 1.6nH, +/-0.1 nH, 0402	Murata	LQG15HS1N6B02D
L4, L5	IND, 560 nH, 5 %, 0603	Coilcraft	0603LS-561XJLB
T1, T2	TRANSFORMER, 1:1	Mini Circuits	TC1-33-75-7+
J3	CONN, HDR	Samtec	TSW-103-07-G-S
J1, J2	CONN, F FEM, 75OHM	Millimeter Wave	MW-846-C-DD-75
C2, C3, C4, C9, C10, C16, C17, C20, C21, R10, R12, R13	DNP		

### Simplified Application Schematic for Downstream (50 – 1218 MHz)

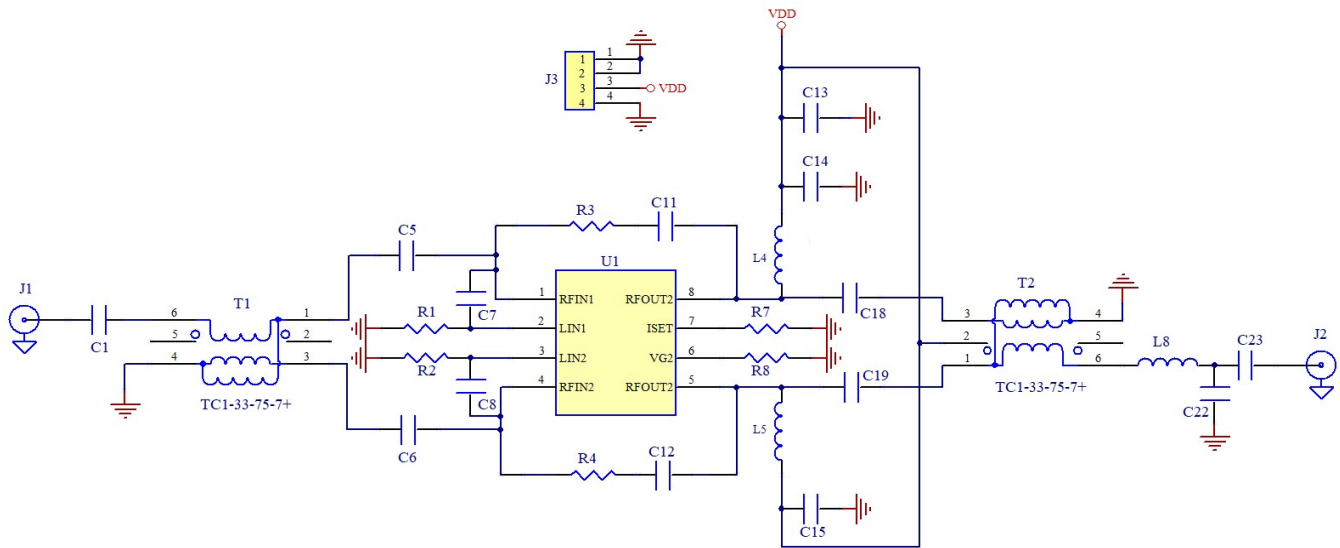

### Bill of Material for Simplified Application: Downstream (50 – 1218 MHz)

Reference Designator	Description	Manufacturer	Part Number
U1	1218 MHz, 17 dB Push-Pull Amp	Qorvo	QPL8831SB
PCB	EVB PCB, QPL8831	Qorvo	QPL883x-4001
C22	CAP, 0.2 pF, +/-0.05 pF, 50 V, 0402	Johanson	500R07S0R2AV4T
C1, C5, C6, C7, C8, C11, C12, C13, C14, C15, C23	CAP, 0.01 uF, 10 %, 50 V, 0402	Murata	GCM155R71H103KA55D
C18, C19	CAP, 270 pF, 5 %, 0402	Murata	GCM1555C1H271JA16D
R7	RES, 1.5 KΩ, 5 %, 1/16 W, 0402	Kamaya	RMC1/16S-152JTH
R8	RES, 3.9 KΩ, 5 %, 1/16 W, 0402	Kamaya	RMC1/16S-392JTH
R3, R4	RES, 470 Ω, 5 %, 1/16 W, 0402	Kamaya	RMC1/16S-471JTH
R1, R2	RES, 1.2 KΩ, 5 %, 1/16 W, 0402	Kamaya	RMC1/16S-122JTH
L8	IND, 1.6nH, +/-0.1 nH, 0402	Murata	LQG15HS1N6B02D
L4, L5	IND, 560nH, 5 %, 0603	Coilcraft	0603LS-561XJLB
T1, T2	TRANSFORMER, 1:1	Mini Circuits	TC1-33-75-7+
J3	CONN, HDR	Samtec	TSW-103-07-G-S
J1, J2	CONN, F FEM, 75OHM	Millimeter Wave	MW-846-C-DD-75

### Simplified Application Schematic for Upstream (5 – 700 MHz)

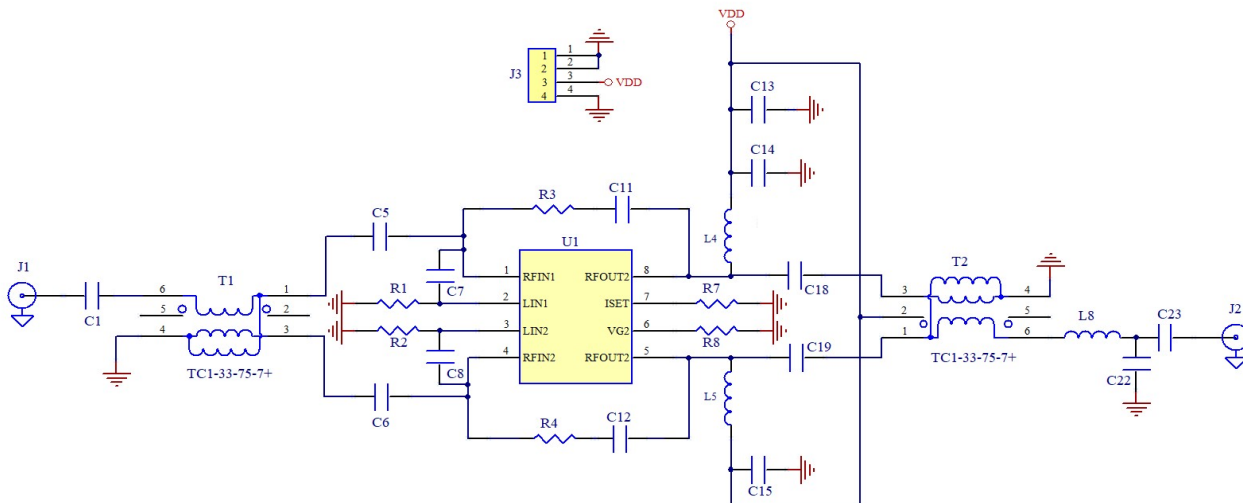

### Bill of Material for Simplified Application: Upstream (5 – 700 MHz)

Reference Designator	Description	Manufacturer	Part Number
U1	1218 MHz, 17 dB Push-Pull Amp	Qorvo	QPL8831SB
PCB	EVB PCB, QPL8831	Qorvo	QPL883x-4001
C22	CAP, 0.2 pF, +/-0.05 pF, 50 V, 0402	Johanson	500R07S0R2AV4T
C7, C8, C11, C12, C13, C14, C15	CAP, 0.01 uF, 10 %, 50 V, 0402	Murata	GCM155R71H103KA55D
C1, C5, C6, C18, C19, C23	CAP, 2.2uF, 10%, 16V, X5R, 0402	Murata	GRM155R61C225KE11D
R7	RES, 1.5 KΩ, 5 %, 1/16 W, 0402	Kamaya	RMC1/16S-152JTH
R8	RES, 3.9 KΩ, 5 %, 1/16 W, 0402	Kamaya	RMC1/16S-392JTH
R3, R4	RES, 470 Ω, 5 %, 1/16 W, 0402	Kamaya	RMC1/16S-471JTH
R1, R2	RES, 1.2 KΩ, 5 %, 1/16 W, 0402	Kamaya	RMC1/16S-122JTH
L8	IND, 1.6nH, +/-0.1 nH, 0402	Murata	LQG15HS1N6B02D
L4, L5	IND, 10uH, 5 %, 0603	Coilcraft	0603HP-10NXJLW
T1, T2	TRANSFORMER, 1:1	Mini Circuits	TC1-33-75-7+
J3	CONN, HDR	Samtec	TSW-103-07-G-S
J1, J2	CONN, F FEM, 75OHM	Millimeter Wave	MW-846-C-DD-75

### Evaluation Board Layout

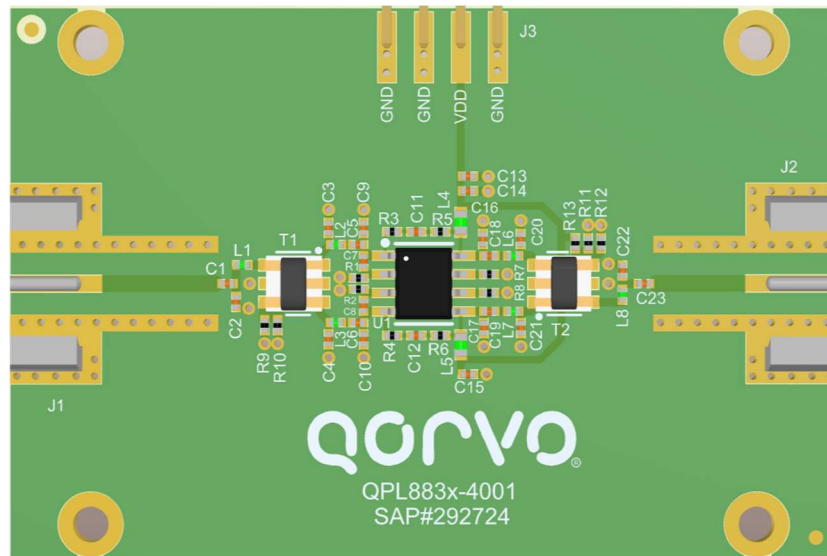
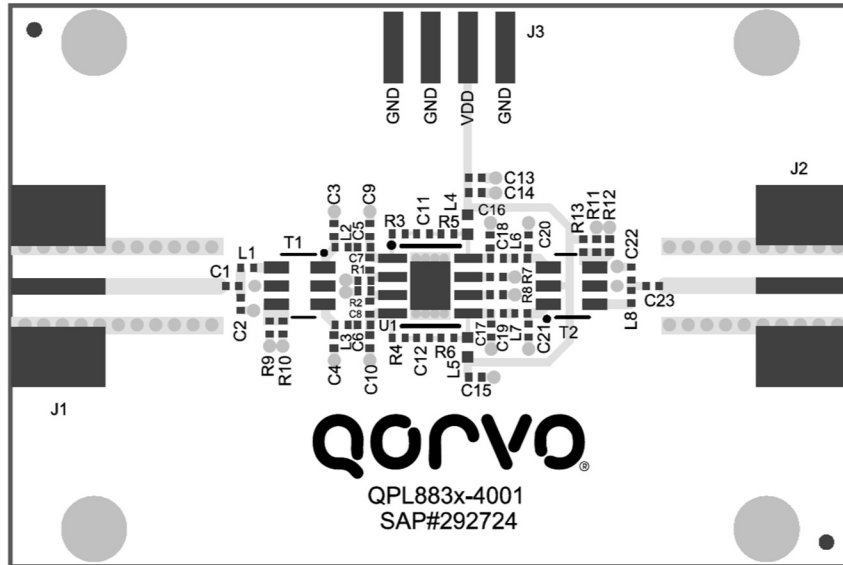

#### EVB PCB Material and Stack-up

Board Material: 59.8mil FR4,  $\epsilon_r=4.2$   
 Plating: 1oz Copper  
 Board Dimension: 2.250" x 1.500"

Layer	Name	Material	Thickness	Constant	Board Layer Stack
	Top Overlay				
	Top Solder	SM-001	0.40mil	3.5	
1	Top Layer	Copper	0.70mil		
	Dielectric 1	FR4	58.00mil	4.2	
2	Bottom Layer	Copper	0.70mil		

Total Thickness: 59.8mil

### Performance Data at 5 V for Downstream (50 – 1218 MHz), 75Ω

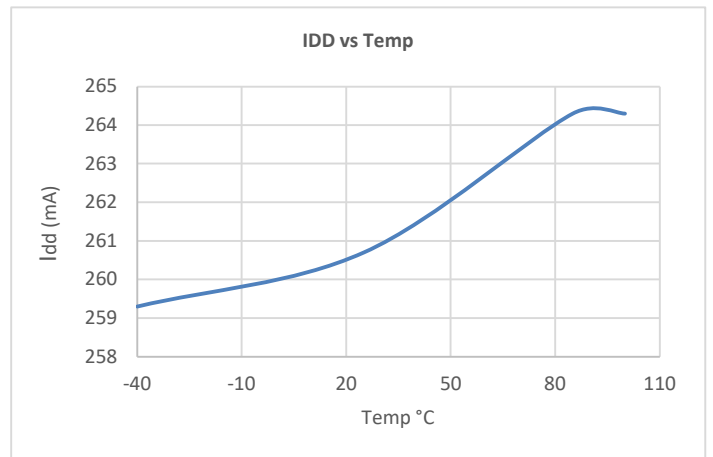
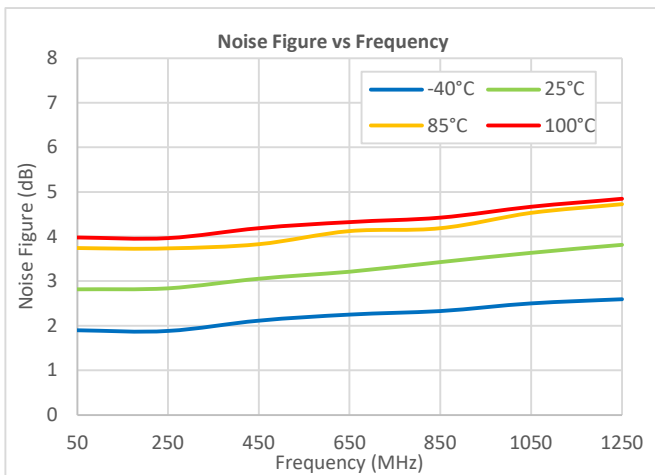
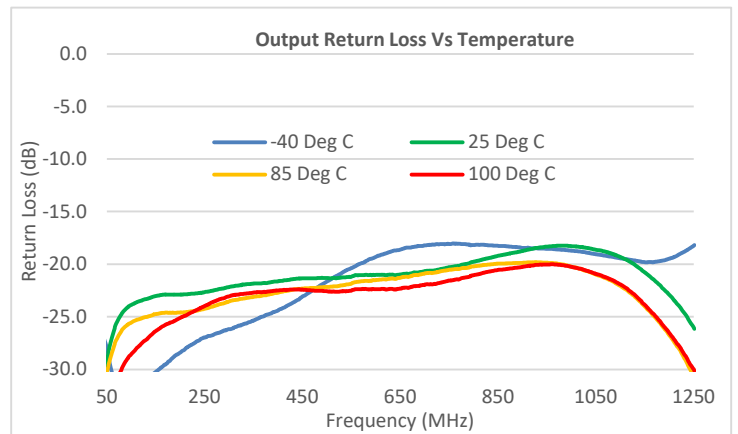
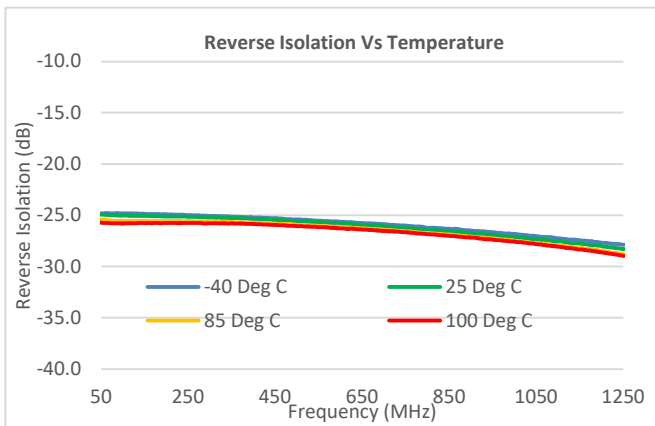
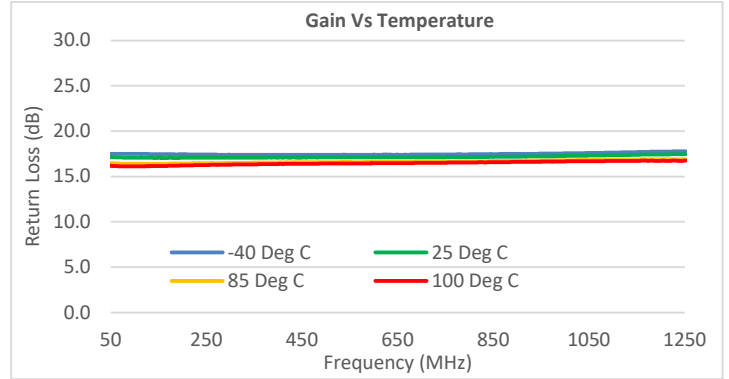
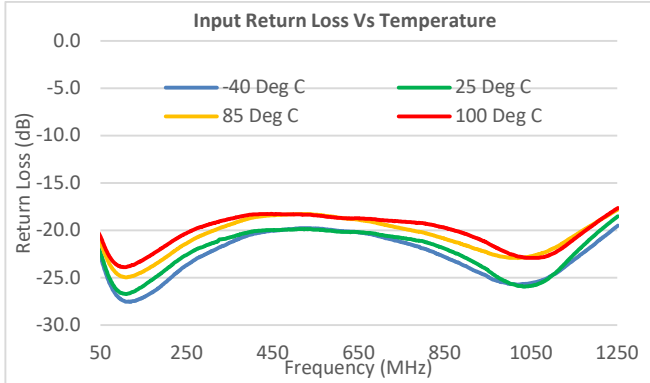

### Performance Data at 5 V for Downstream (50 – 1218 MHz), 75Ω

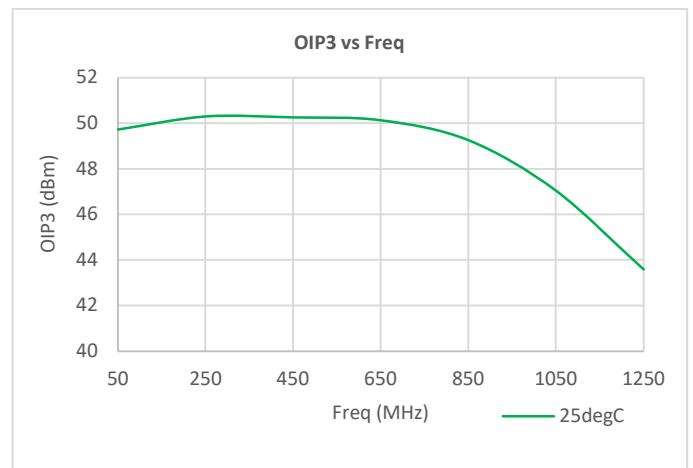
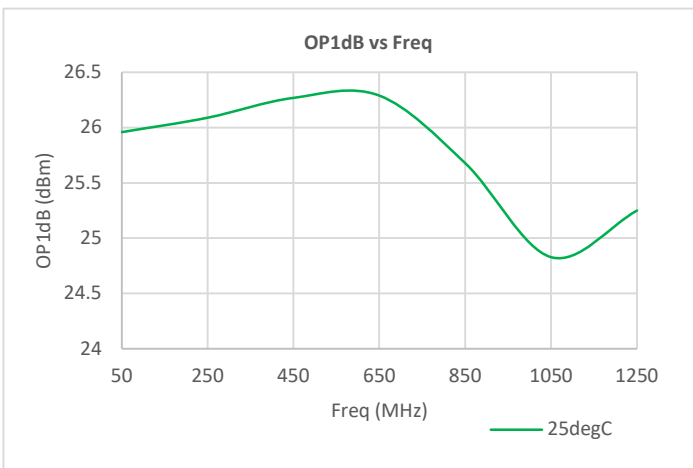
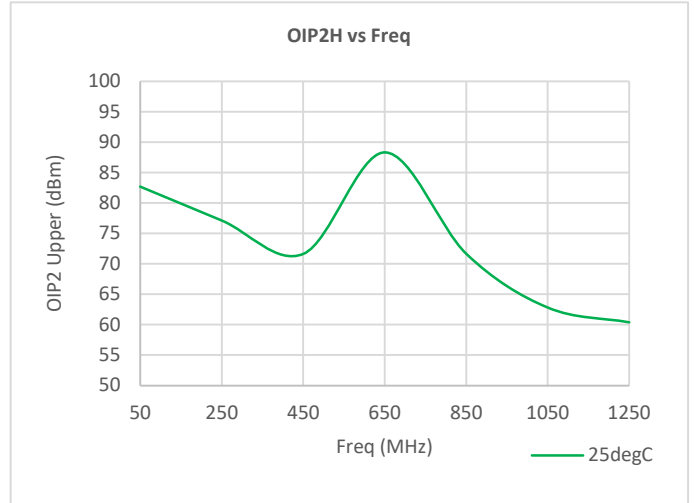
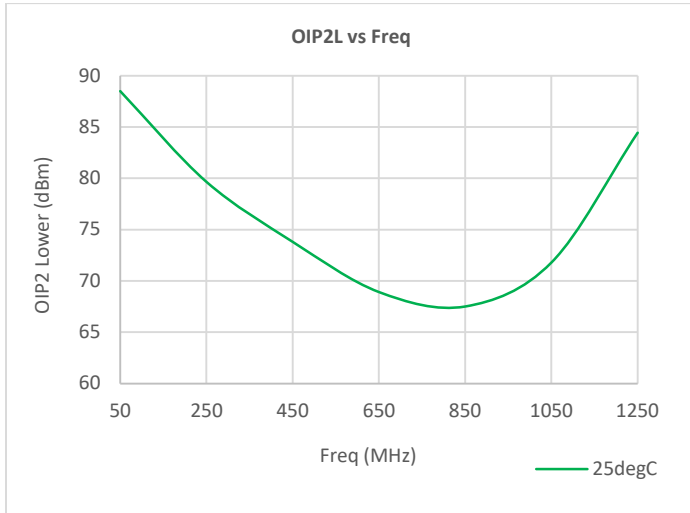

**Notes:**

1. OIP2: 13 dBm / tone output,  $\Delta f = 50$  MHz, 50-1218 MHz.
2. OIP3: 13 dBm / tone output,  $\Delta f = 6$  MHz, 50-1218 MHz.



### Performance Data at 5V for Downstream (50 - 1218 MHz) with 0dB Tilt, 75Ω

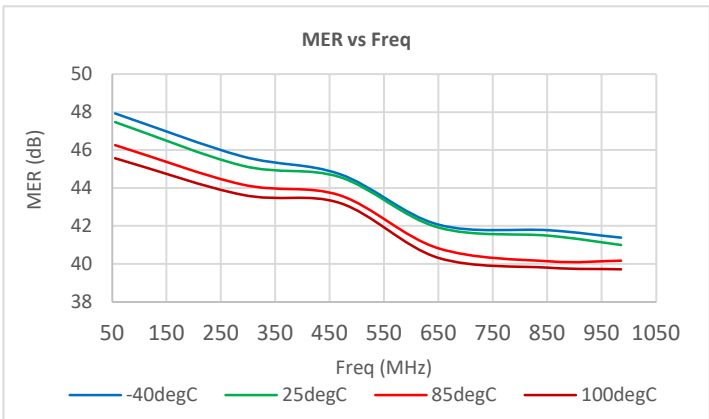
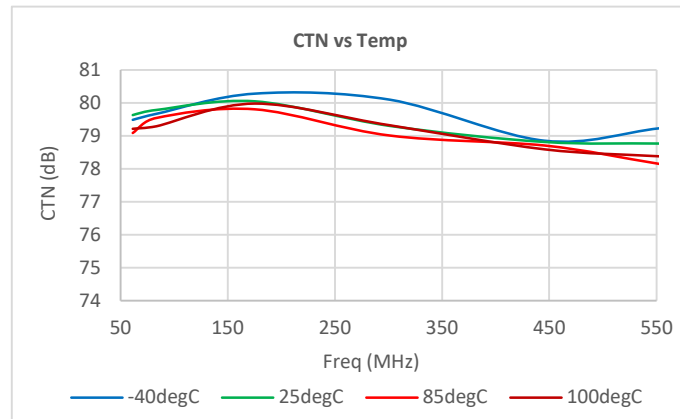
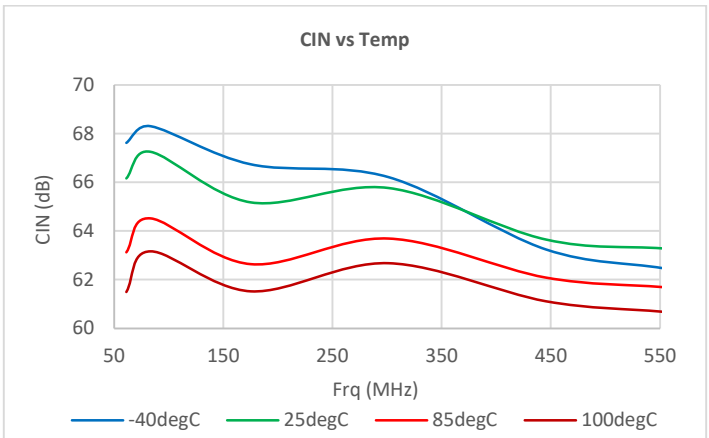
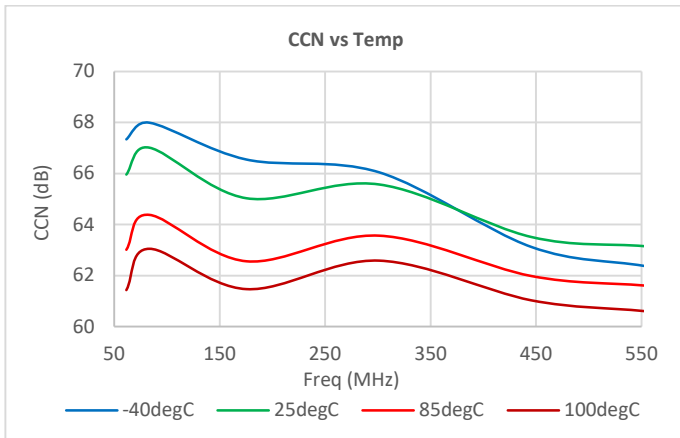
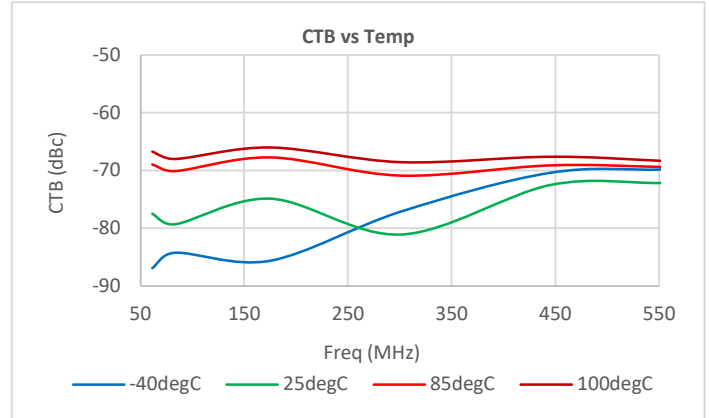
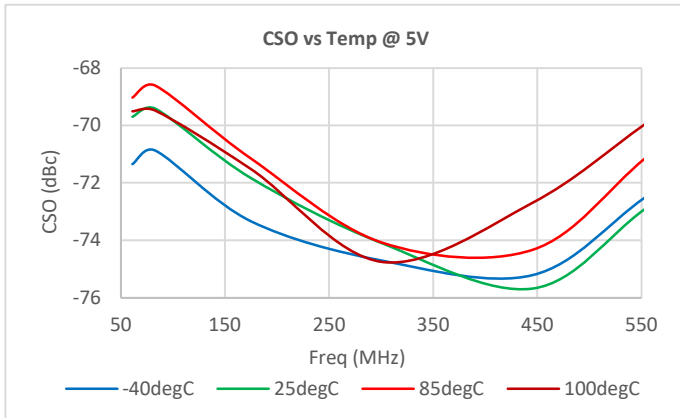

**Notes:**

1. For Composite Distortion Plots, 80Ch NTSC + 111QAM, 6dB offset, Pout = 43dBmV / Ch
2. For MER plot, TCP = 65dBmV, 160 Ch QAM

### Performance Data at 5 V for Downstream ( 50 – 1218 MHz ) with 10 dB Tilt, 75Ω

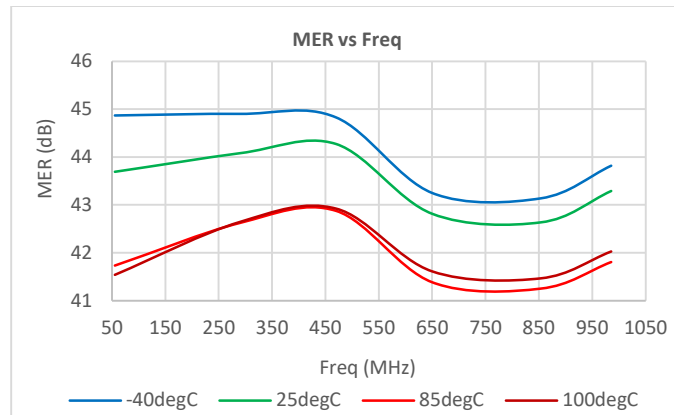
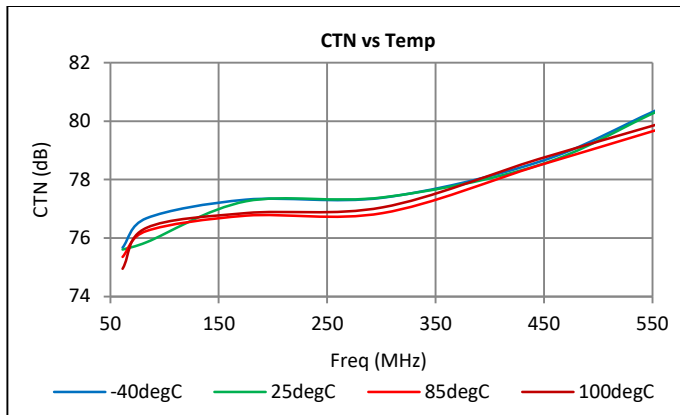
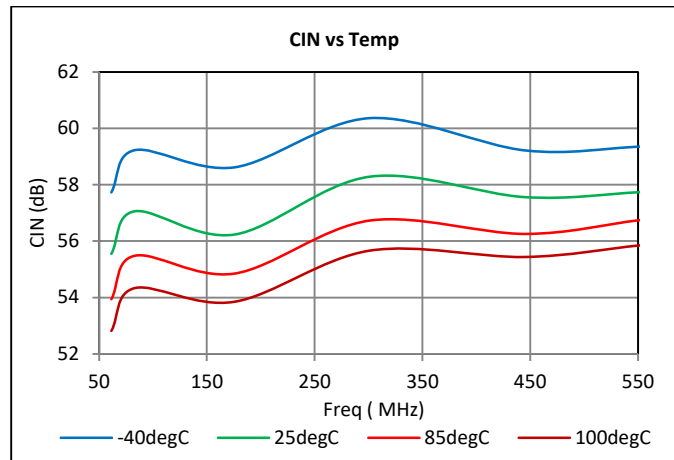
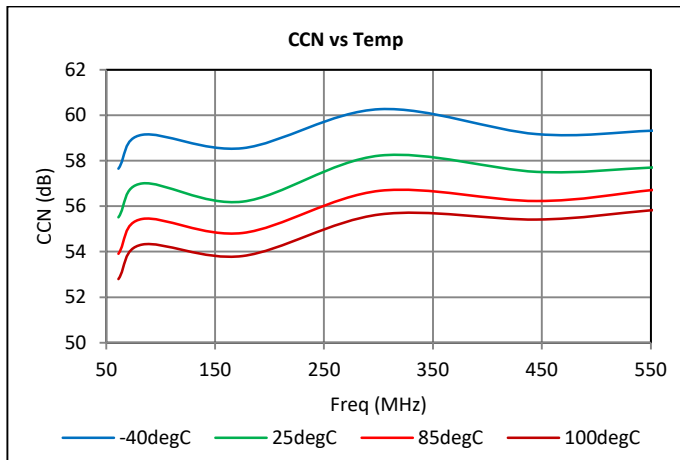
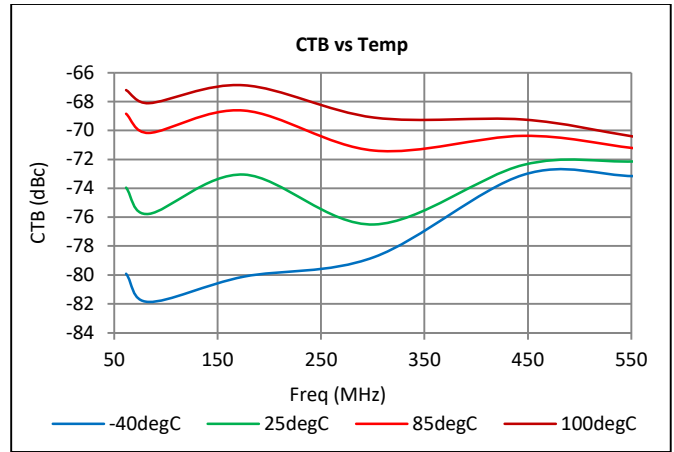
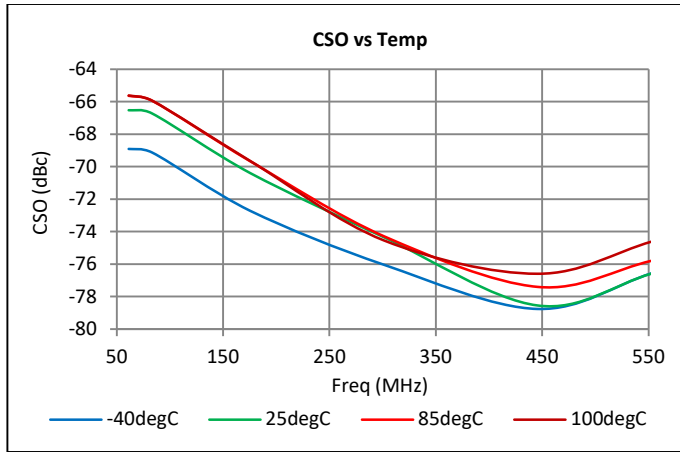

**Notes:**

1. For Composite Distortion Plots, 80Ch NTSC + 111 QAM, 6dB offset, Pout = 49 dBmV / Ch at 1218MHz virtual.
2. For MER plot, TCP = 65dBmV, 160 Ch QAM

### Performance Data at 5 V for Upstream (5 – 700 MHz), 75Ω

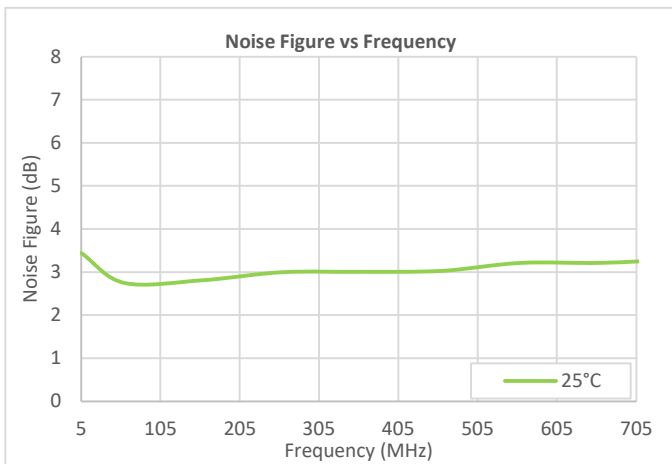
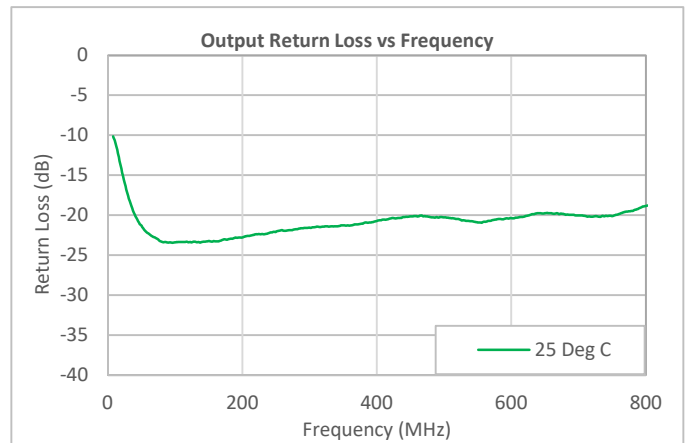
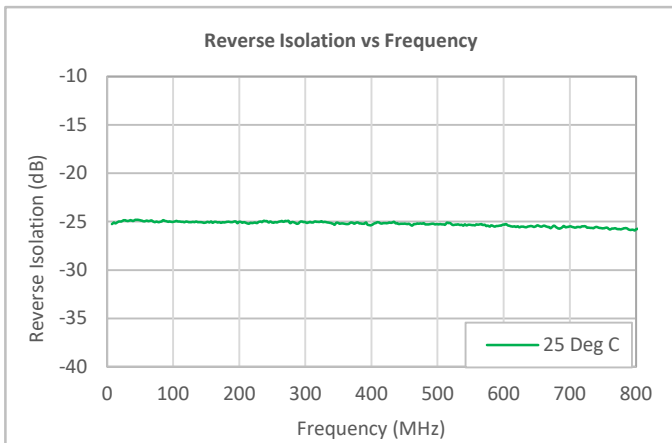
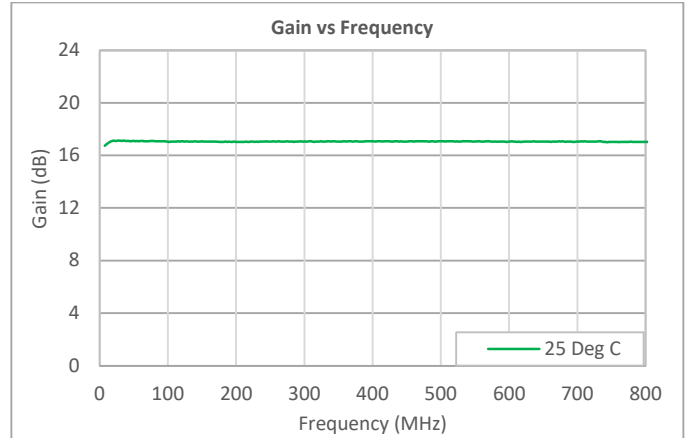
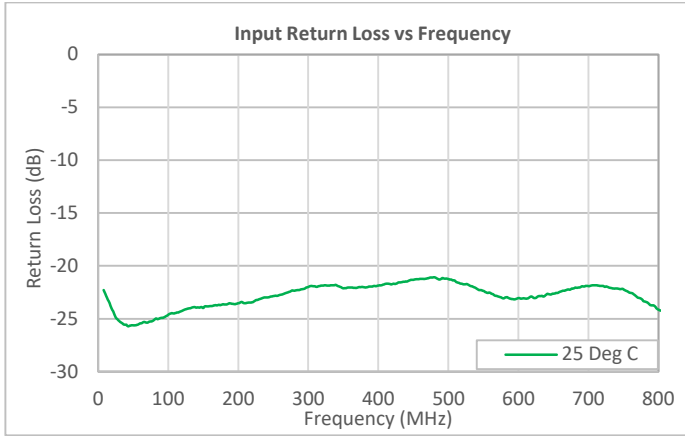

### Performance Data at 5 V for Upstream (5 – 700 MHz), 75Ω

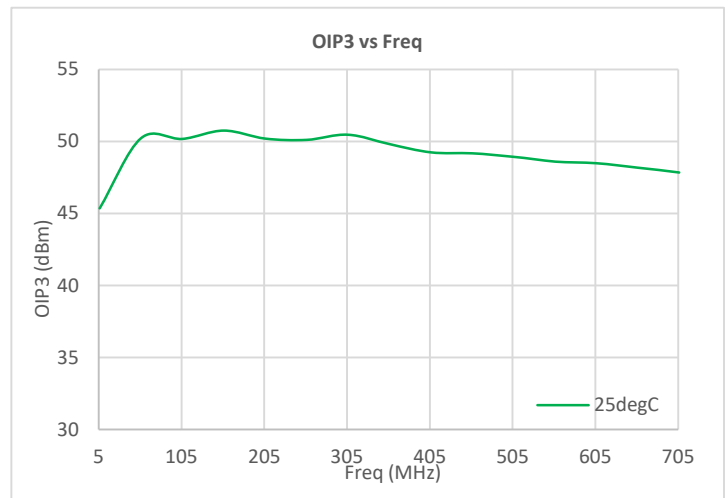
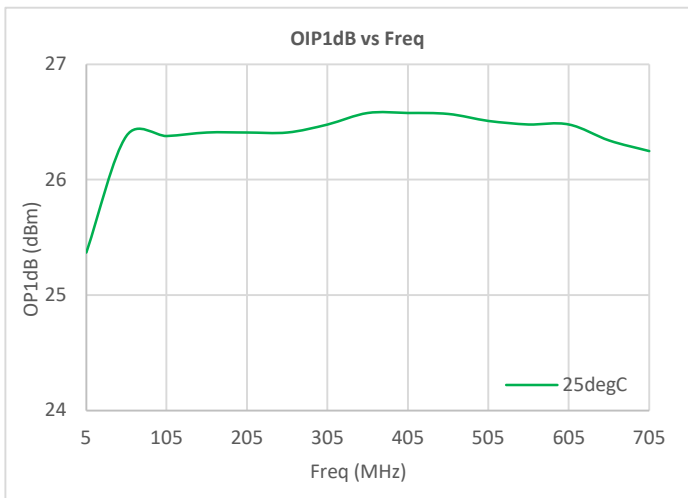
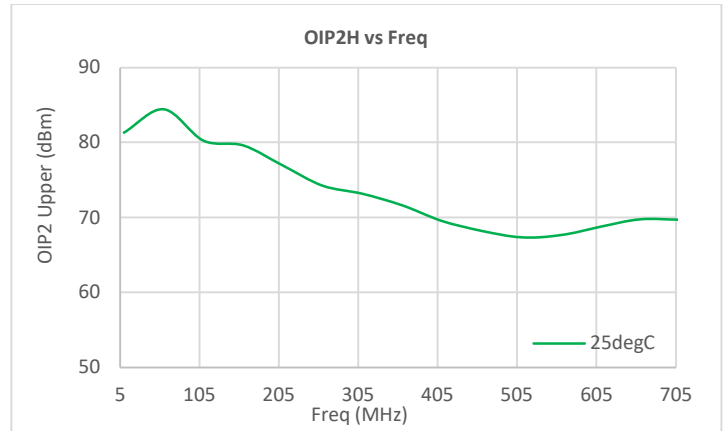
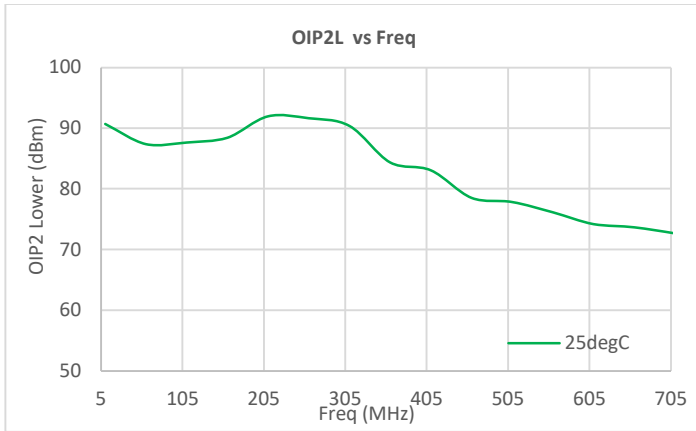

**Notes:**

1. OIP2: 13 dBm / tone output,  $\Delta f = 50$  MHz, 5-700 MHz
2. OIP3: 13 dBm / tone output,  $\Delta f = 6$  MHz, 5-700 MHz

### Linearizer Current Settings

The linearizer circuitry is basically a pre-distortion circuit that can correct for 3<sup>rd</sup> order non-linearity. The amount of pre-distortion correction is set by ILIN. The linearizer circuit is coupled to the main amplifiers thru C7 and C8. Disconnecting C7 and C8 will disable the linearizer which causes the gain to increase slightly (~0.5dB) but will also degrade S11 and OIP3.

In the application circuit, R1 and R2 are used to set the linearizer current (ILIN). The ILIN can be calculated using the equation below.

$$ILIN = 2 \cdot (V_{DD} - 1.6V) / (R1 + 1125)$$

The value of ILIN has been optimized for the QPL8831 at 280mA. In applications where reduced IDD is needed, ILIN should also be reduced to achieve best linearity.

The graph on the right hand side shows the change in ILIN vs. R1, R2.

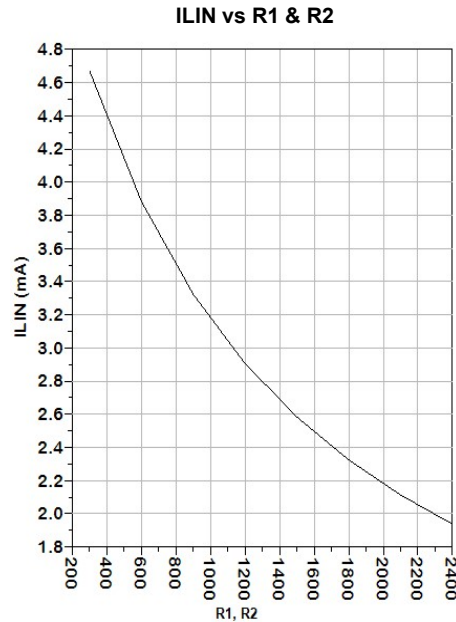

### ISET Resistor Value

The resistor R7 is used to set the device current. In QPL8831 application circuit, the value of R7 is set to get an IDD of 280mA which is optimal for linearity at 5V. In applications where reduced linearity is acceptable, IDD can be reduced lowering the value of R7 (see graph below).

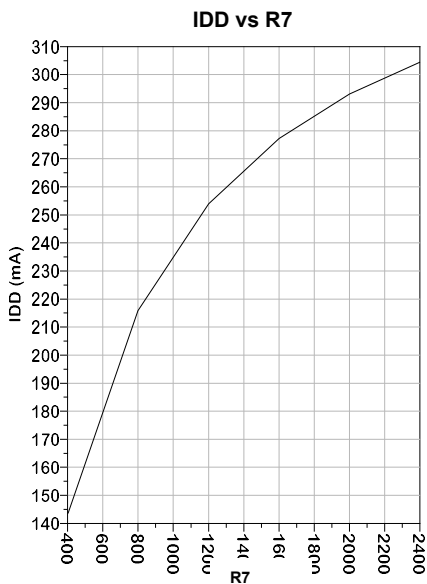

### VG2 Resistor Value Settings

VG2 (pin 6) is connected to the gate of the output device. Resistor R8 is used to fine tune VG2 for best linearity.

Recommended range for R8 is 3k to 7k.

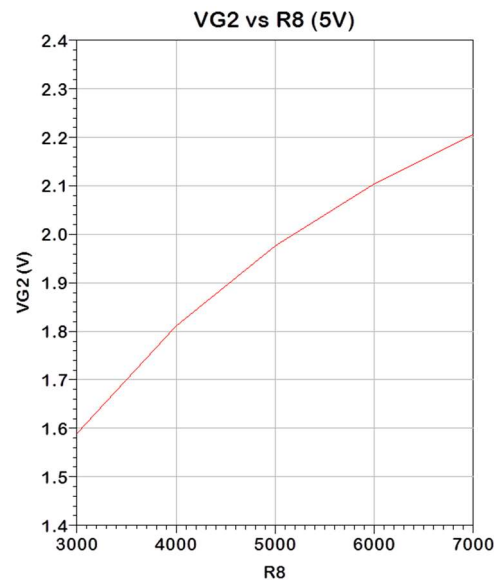

### Package Marking

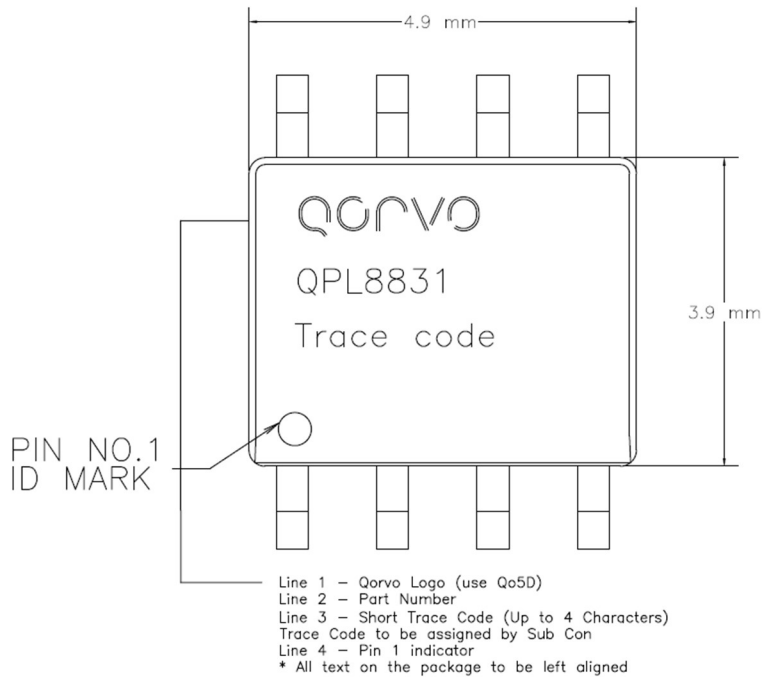

### Pin Configuration and Description

Pin	Name	Description
1	RFIN1	RF input for plus side of amplifier
2	LIN1	Linearizer Current Set for plus side of amplifier
3	LIN2	Linearizer Current Set for minus side of amplifier
4	RFIN2	RF input for minus side of amplifier
5	RFOUT2	RF output for minus side of amplifier
6	VG2	VG2 Adjust
7	ISET	IDD Set
8	RFOUT1	RF output for plus side of amplifier
9	GND	Exposed bottom of part, device ground

### Package Outline

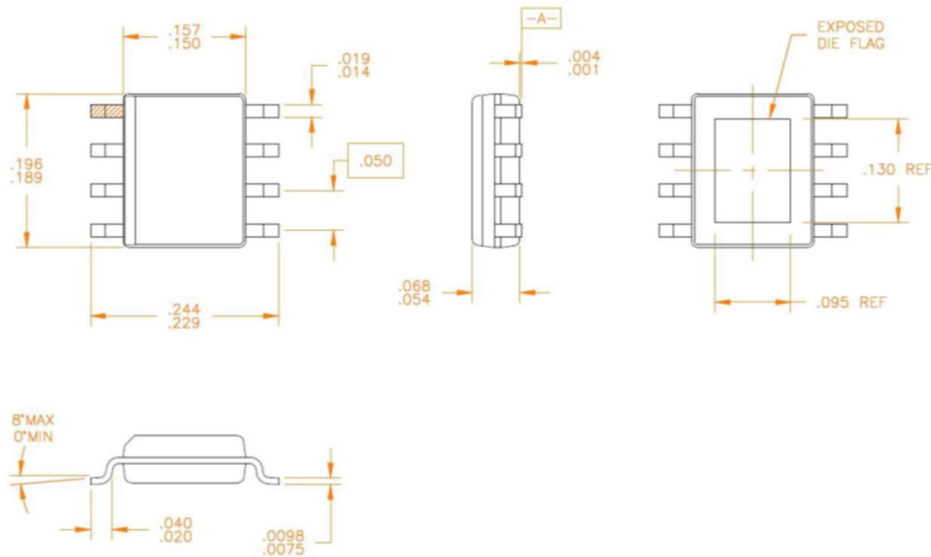

1. All dimensions are in inches. Angles are in degrees.

#### Notes:

1. All Dimensions are in inches.
2. Angles are in degrees.

### Recommended Mounting Pattern

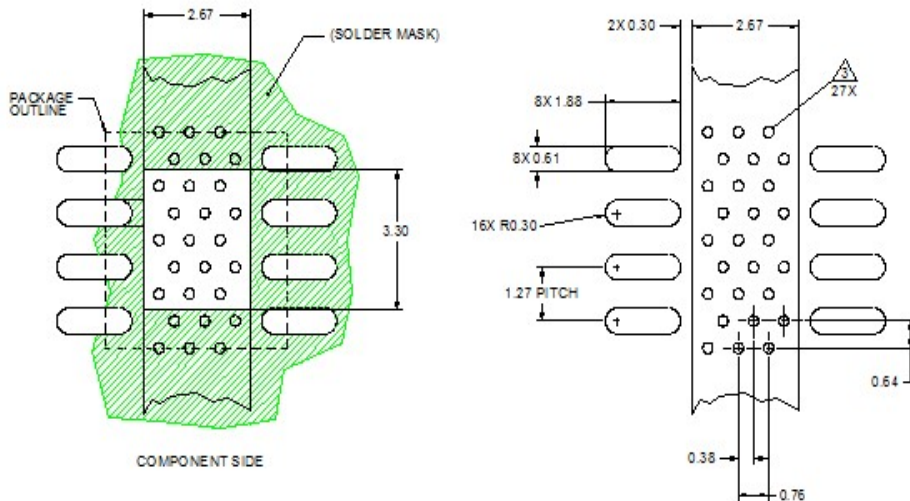

Notes: All dimensions are in millimeters. Angles are in degrees.

1. Use 1 oz. copper minimum for top and bottom layer metal.
2. Vias are required under the backside paddle for proper RF/DC grounding and thermal dissipation.
3. Recommend a 0.35 mm diameter bit for drilling via holes and a final plated thru diameter of 0.25 mm.