

Product Overview

The QPL8834 is an ultra-linear GaAs pHEMT 75-Ohm RF balanced amplifier IC with 5 MHz to 1218 MHz operating bandwidth, featuring high linearity, high gain and low noise for use as Post Amplifier in Optical Receivers or as a low noise balanced preamp. This IC uses a 5V supply for applications requiring lower power dissipation. Due to its wide operational bandwidth, the QPL8834 can be used as a downstream amp in DOCSIS 3.1 as well as an upstream amplifier for DOCSIS 3.1 or DOCSIS 4.0 applications.



8-Pin SOIC Package

Functional Block Diagram

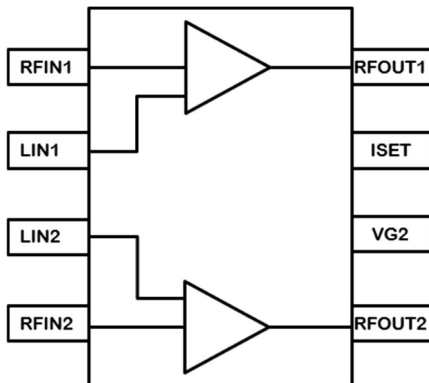

Key Features

- Gain: 12 dB @ 1218 MHz
- Bandwidth: 5 – 1218 MHz
- OIP3: +42 dBm
- OP1dB: 24 dBm
- Low Noise Figure: 4 dB
- Excellent Composite Distortion
- pHEMT GaAs device technologies
- Compact Size: 8-pin SOIC
- Power Consumption (5 V, 280 mA, 1.4 W)

Applications

- DOCSIS 3.1 Systems
- Balanced Antenna Applications
- HFC Optical Nodes
- 75-Ohm amplifiers
- Upstream amplifier for DOCSIS 3.1 and DOCSIS 4.0 Applications.

Ordering Information

Part Number	Description
QPL8834SB	Sample bag with 5 pieces
QPL8834SR	7" Reel with 100 pieces
QPL8834TR13	13" Reel with 2500 pieces
QPL8834PCK-01	47 – 1218 MHz PCBA

Absolute Maximum Ratings

Parameter	Rating
Supply Voltage (V_{DD})	+ 8 V
Supply Current (I_{DD})	400 mA
Maximum Input Level (single tone)	+ 15 dBm
Operating Temperature Range	- 40 to + 85 °C
Storage Temperature Range	- 40 to +150 °C
Maximum Junction Temperature	+ 150 °C

Exceeding any one or a combination of the Absolute Maximum Rating conditions may cause permanent damage to the device. Extended application of Absolute Maximum Rating conditions to the device may reduce device reliability.

Electrical Specifications

Parameter	Condition ⁽¹⁾	Min	Typ	Max	Unit
Supply Voltage (V_{DD})			5		V
Supply Current (I_{DD})	V_{DD} total current	255	280		mA
Frequency Range		5		1218	MHz
Gain	5–1218 MHz		12		dB
Gain Flatness			±0.5		dB
Input Return Loss			18		dB
Output Return Loss			18		dB
Noise Figure			4		dB
CSO	80 NTSC + 111 QAM, flat tilt, 42 dBmV / Ch Output at 1218MHz		-73		dBc
CTB			-72		dBc
CCN			62		dB
OIP2	13 dBm / tone, $\Delta f = 50$ MHz, Full Band		67		dBm
OIP3	13 dBm / tone, $\Delta f = 6$ MHz, Full Band		42		dBm
Output P1dB	Full Band		24		dBm
Thermal Resistance			13		°C/W

Notes:

1. Typical performance at these conditions: Temp = + 25 °C, $V_{DD} = + 5$ V, 75 Ω system, Full band unless otherwise noted

Evaluation Board Schematic

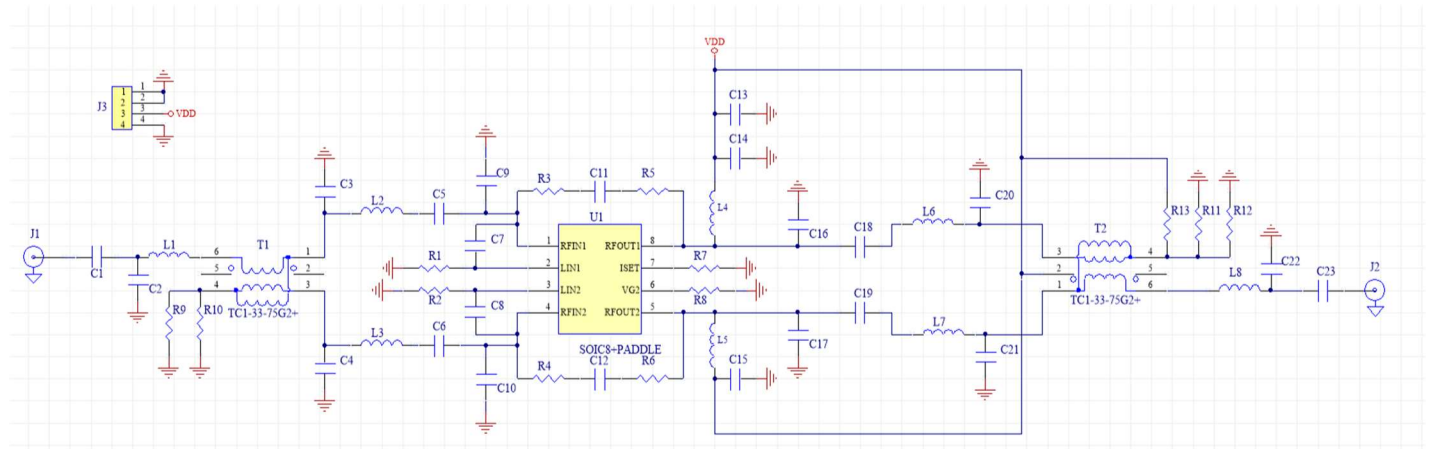

Evaluation Board Bill of Materials for Downstream (50-1218MHz)

Reference Designator	Description	Manufacturer	Manufacturer PN
U1	1218 MHz, 12 dB Push-Pull Amp	Qorvo	QPL8834SB
PCB	EVB PCB, QPL8834	Qorvo	QPL883x-4001
C1, C5, C6, C7, C8, C11, C12, C13, C14, C15, C23	CAP, 0.01uF, 5 %, 50 V, COG, 0402	Murata	GCM155R71H103KA55D
C3, C4	CAP, 0.3 pF, 0402	Murata	GRM615COG0R3B50K500
C18, C19	CAP, 270 pF, 5 %, 0402	Murata	GCM1555C1H271JA16D
C22	CAP, 0.5pF, 0402	Murata	GJM1555C1HR50WB01D
R5, R6, R9, R11, L1, L6, L7	RES, 0 Ω, 0402	Kamaya	RMC1/16SJPTH
R7	RES, 2.2 KΩ, 5 %, 1/16 W, 0402	Kamaya	RMC1/16S-222JTH
R8	RES, 6.8 KΩ, 5 %, 1/16 W, 0402	Kamaya	RMC1/16S-682JTH
R3, R4	RES, 330 Ω, 5 %, 1/16 W, 0402	Kamaya	RMC1/16S-331JTH
R1, R2	FER BEAD, 1.8K, 200mA, 0402	TDK	MMZ1005A182ET000
L4, L5	IND, 560nH, 5 %, 0603	Coil craft	0603LS-561XJLB
L2, L3	RES, 4.7Ω, 0402	Kamaya	RMC1/16S-4R7JTH
L8	IND, 2.7nH, 0402	Murata	LQG15HS2N7S02D
T1, T2	TRANSFORMER, 1:1	Mini Circuits	TC1-33-75-7+
J3	CONN, HDR	Samtec	TSW-103-07-G-S
J1, J2	CONN, F FEM, 75Ω	Millimeter Wave	MW-846-C-DD-75
C2, C9, C10, C16, C17, C20, C21, R10, R12, R13	DNP		

Typical Application Circuit

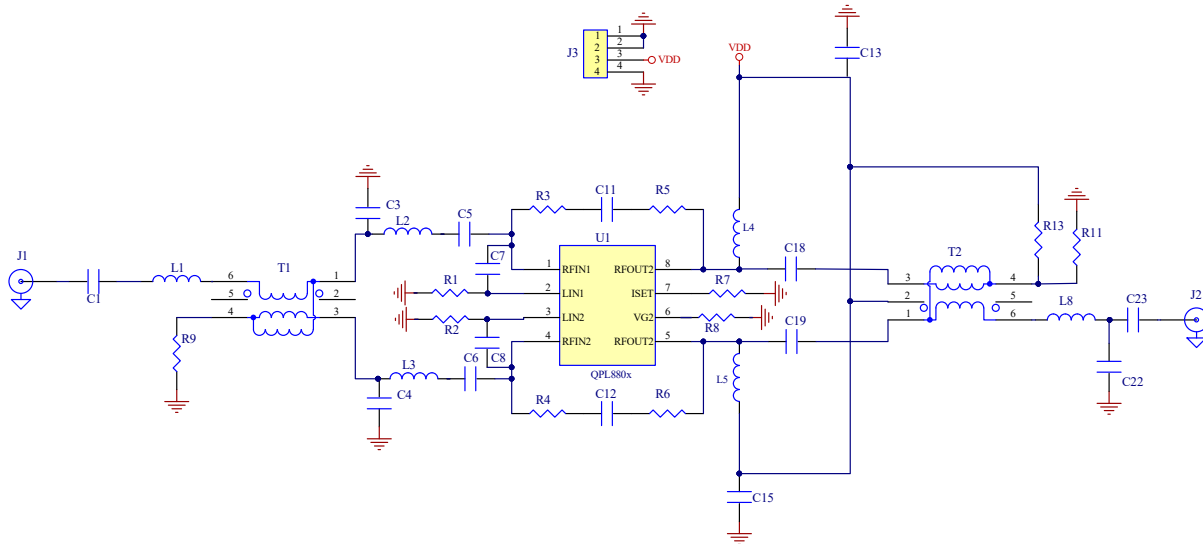

Evaluation Board Bill of Materials for Upstream (5-700MHz)

Reference Designator	Description	Manufacturer	Manufacturer PN
U1	1218 MHz, 12 dB Amp	Qorvo	QPL8834SB
PCB	EVB PCB, QPL8834	Qorvo	QPL883x-4001
C7, C8, C11, C12, C13, C14, C15	CAP, 0.01uF, 5 %, 50 V	Murata	GCM155R71H103KA55D
C1, C5, C6, C18, C19	CAP, 2.2uF, 10%, 16V, X5R	Murata	GRM155R61C225KE11D
C3, C4	CAP, 0.3 pF, 0402	Murata	GRM615COG0R3B50K500
C23	CAP, 1nF	Murata	GRM155R61C102KA01D
C22	CAP, 0.5pF, 0402	Murata	GJM1555C1HR50WB01D
R5, R6, R9, R11, L1, L6, L7	RES, 0 Ω, 0402	Kamaya	RMC1/16SJPTH
R7	RES, 2.2 KΩ, 5 %, 1/16 W	Kamaya	RMC1/16S-222JTH
R8	RES, 6.8 KΩ, 5 %, 1/16 W	Kamaya	RMC1/16S-682JTH
R3, R4	RES, 330 Ω, 5 %, 1/16 W	Kamaya	RMC1/16S-331JTH
L4, L5	IND, 10uH, 5 %, 0603	Coil craft	0603AF-103
R1, R2	IND, 22uH, 5 %, 0603	Coil craft	0603LS-223
L2, L3	RES, 4.7Ω, 0402	Kamaya	RMC1/16S-4R7JTH
L8	IND., 2.7nH, 0402	Murata	LQG15HS2N7S02D
T1, T2	TRANSFORMER, 1:1	Mini Circuits	TC1-33-75-7+
J3	CONN, HDR	Samtec	TSW-103-07-G-S
J1, J2	CONN, F FEM, 750 Ω	MM Wave	MW-846-C-DD-75
C2, C9, C10, C16, C17, C20, C21, R10, R12, R13	DNP		

Evaluation Board Layout

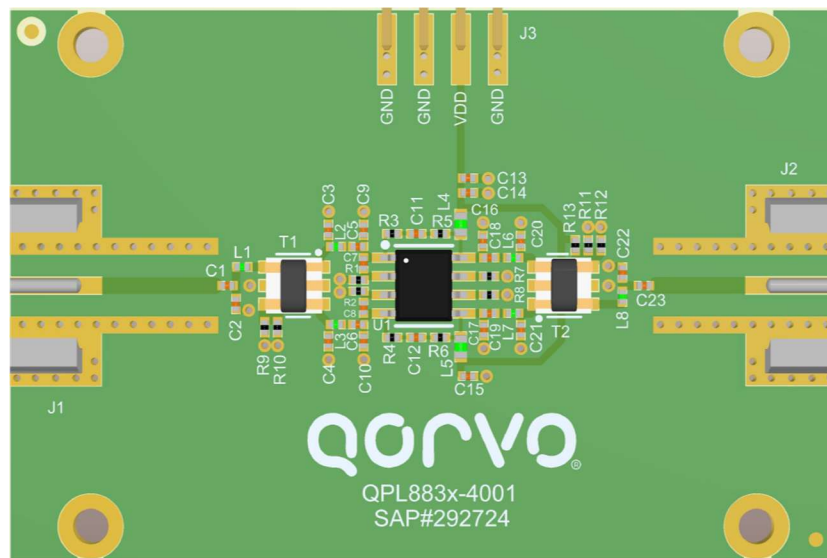
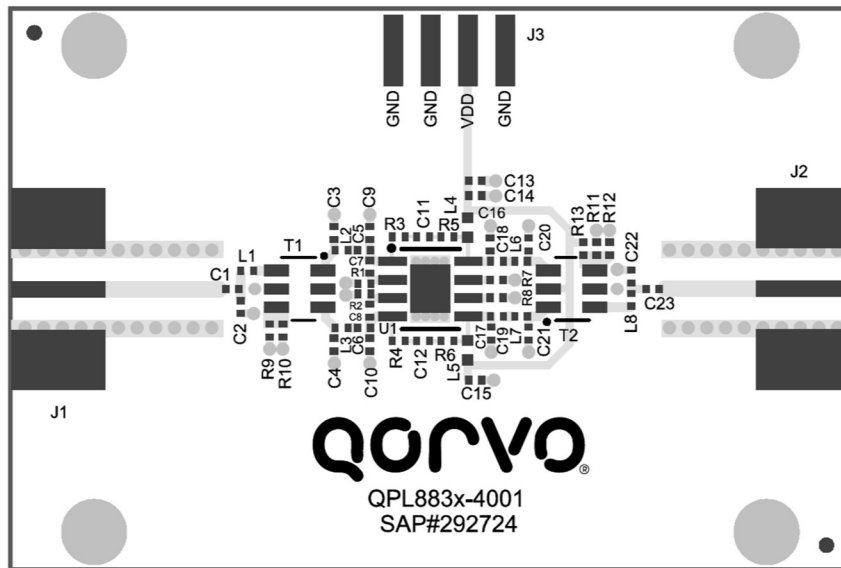

EVB PCB Material and Stack-up

Board Material: 59.8mil FR4, $\epsilon_r=4.2$
 Plating: 1oz Copper
 Board Dimension: 2.250" x 1.500"

Layer	Name	Material	Thickness	Constant	Board Layer Stack
	Top Overlay				
	Top Solder	SM-001	0.40mil	3.5	
1	Top Layer	Copper	0.70mil		
	Dielectric 1	FR4	58.00mil	4.2	
2	Bottom Layer	Copper	0.70mil		

Total Thickness: 59.8mil

Performance Data at +5V for Downstream (50-1218MHz), 75 Ω

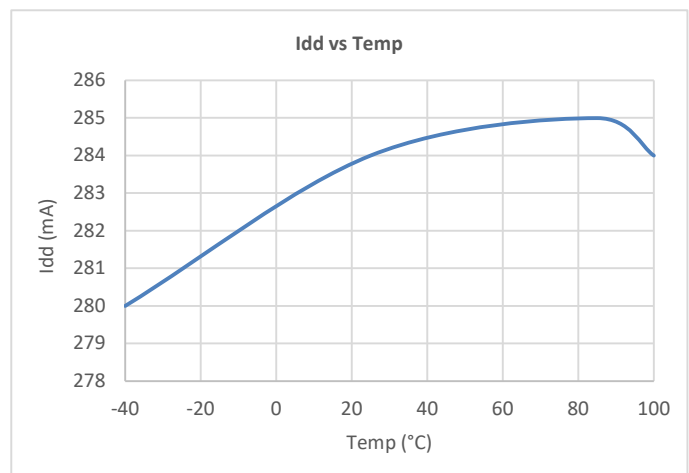
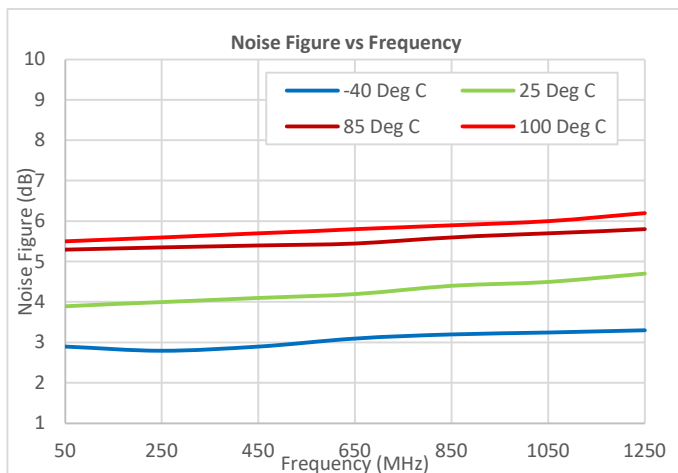
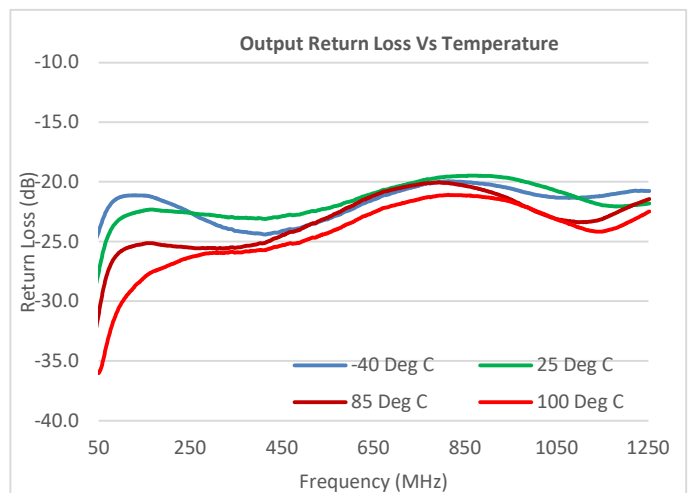
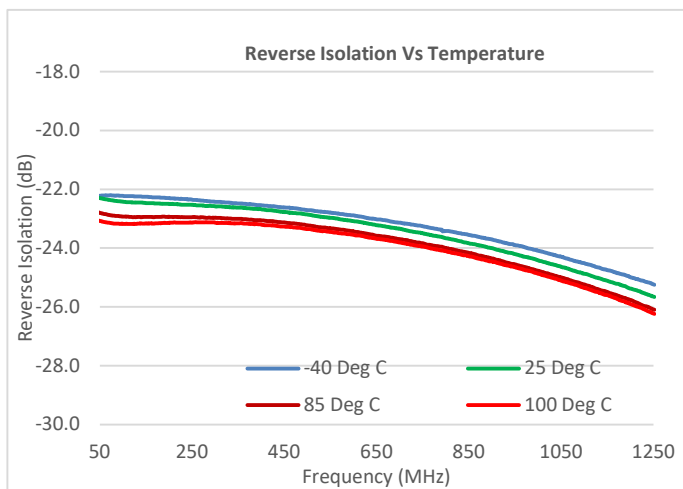
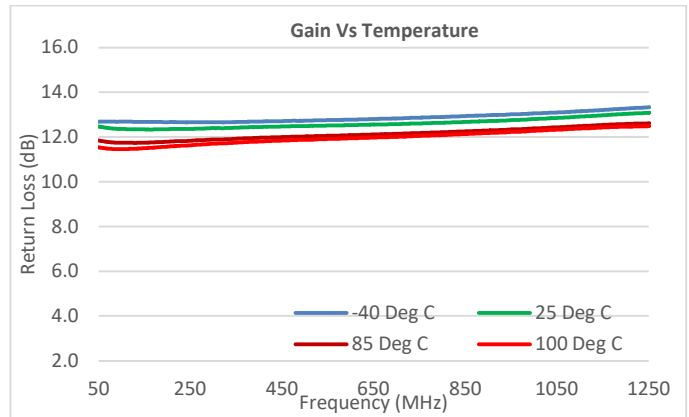
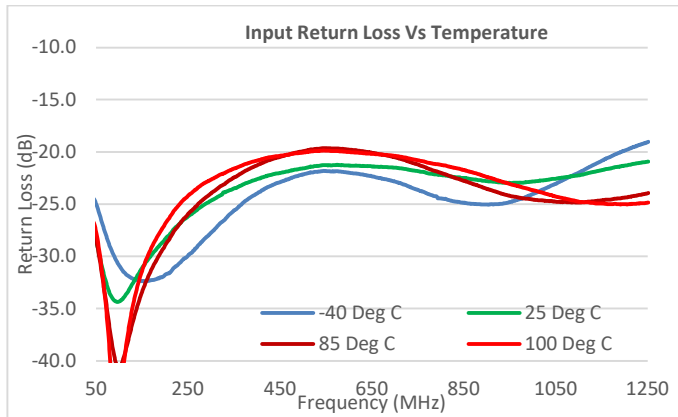

Performance Data at +5V, 25°C for Downstream (50-1218MHz), 75 Ω

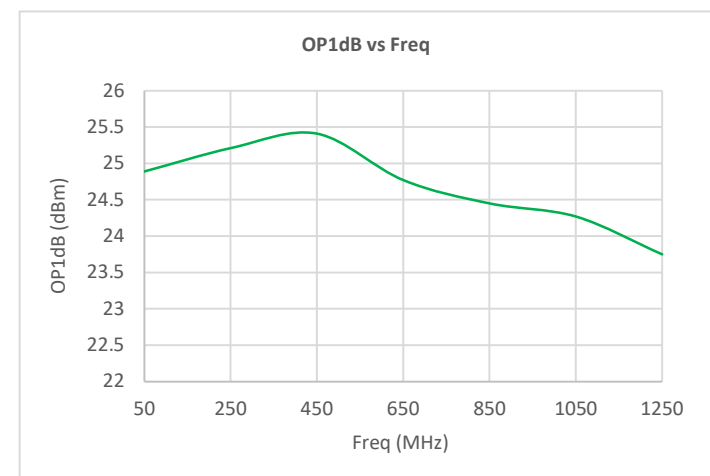
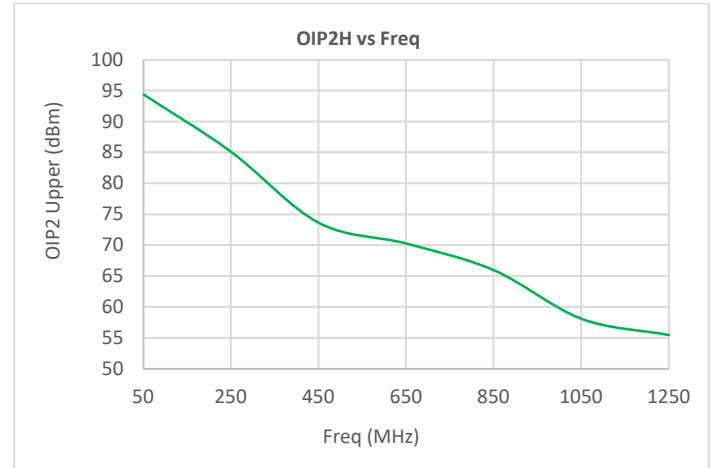
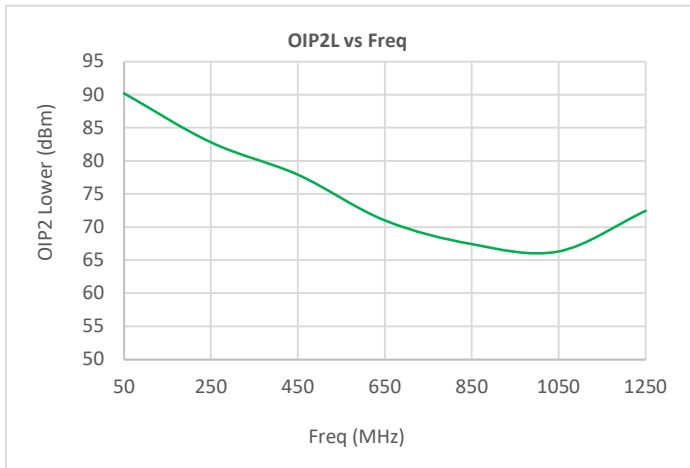

Notes:

1. OIP2: 13dBm / tone output, $\Delta f = 50$ MHz, Full Band.
2. OIP3: 13dBm / tone output, $\Delta f = 6$ MHz, Full Band
3. Temp = +25°C, VDD = +5V, 75Ω system.

Performance Data at +5 V, 25°C for Downstream (50-1218MHz), 75 Ω

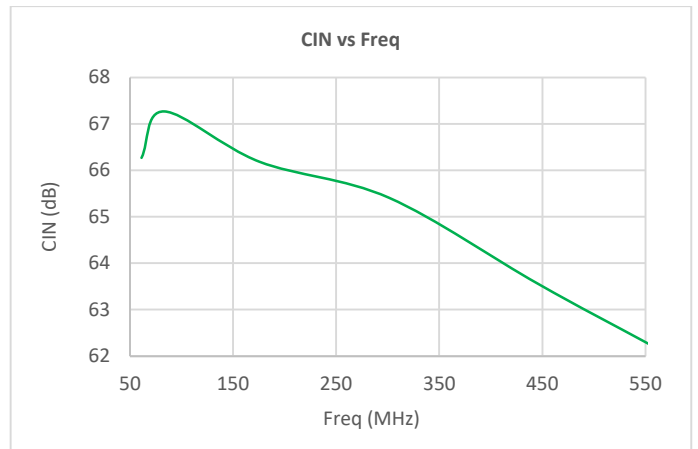
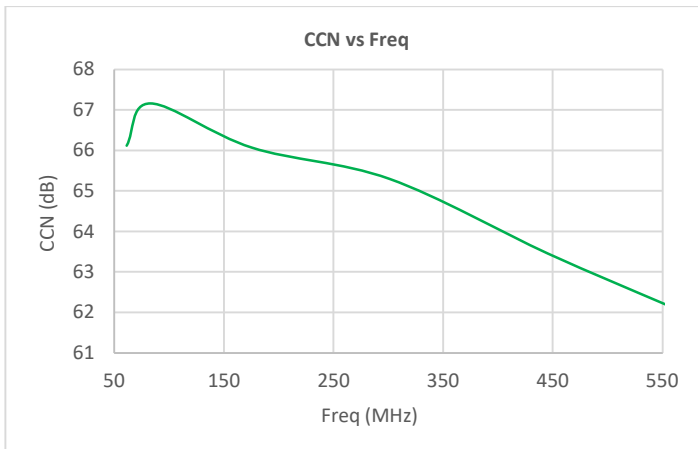
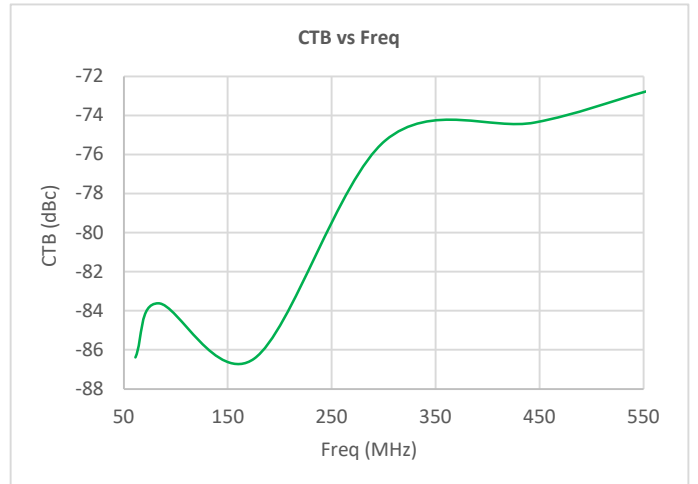
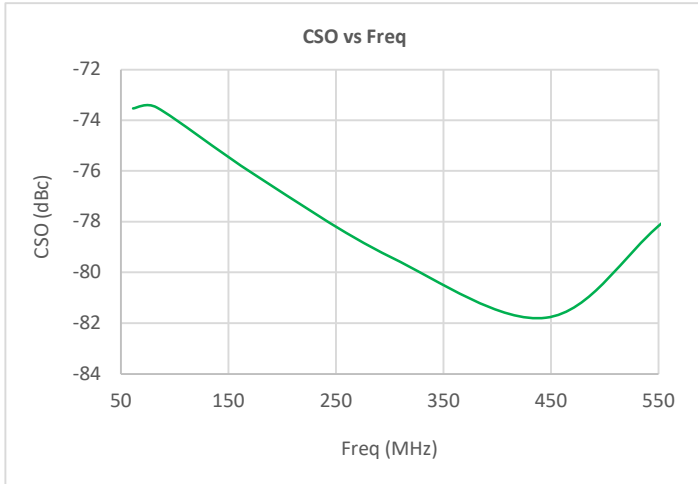

Notes:

1. 80 NTSC + 111 QAM, Flat Tilt, 42dBmV / Ch, Output at 1218MHz.
2. Temp = +25°C, VDD = +5V, 75Ω system.

Performance Data at +5 V, 25°C for Upstream (5 – 700 MHz), 75Ω

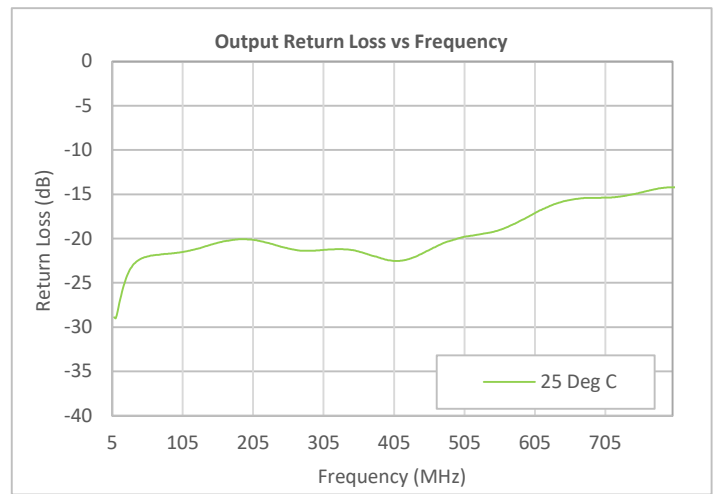
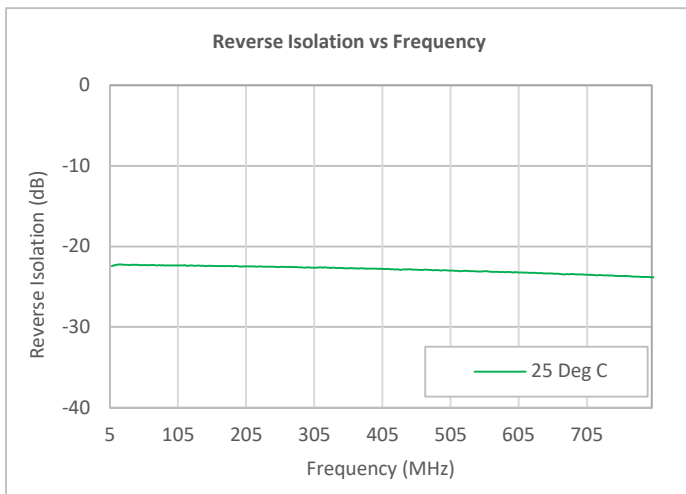
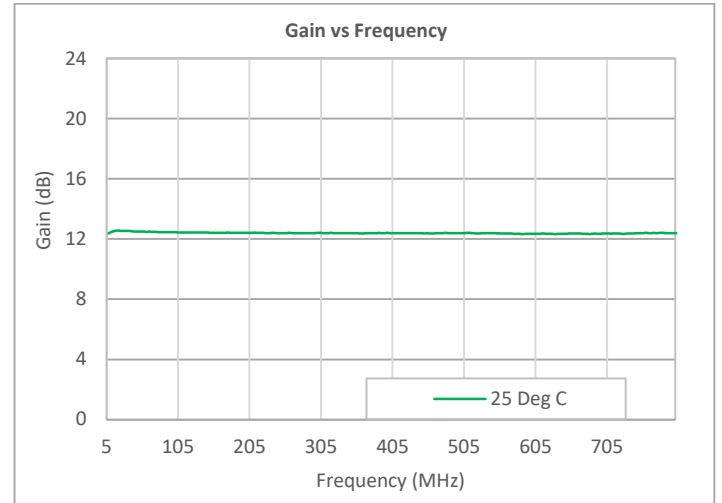
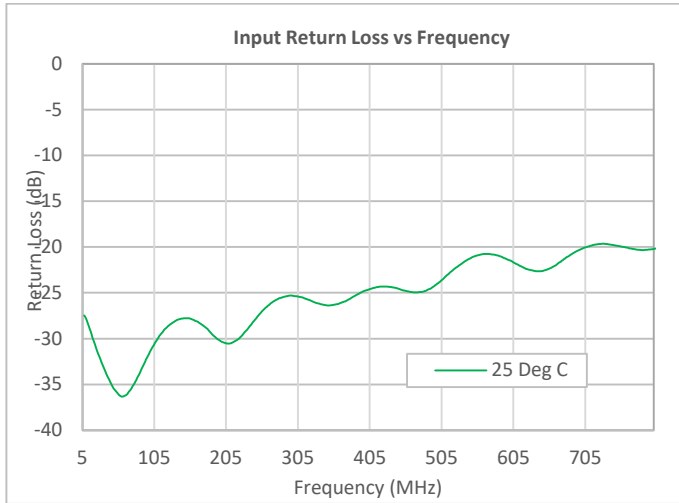

Package Marking

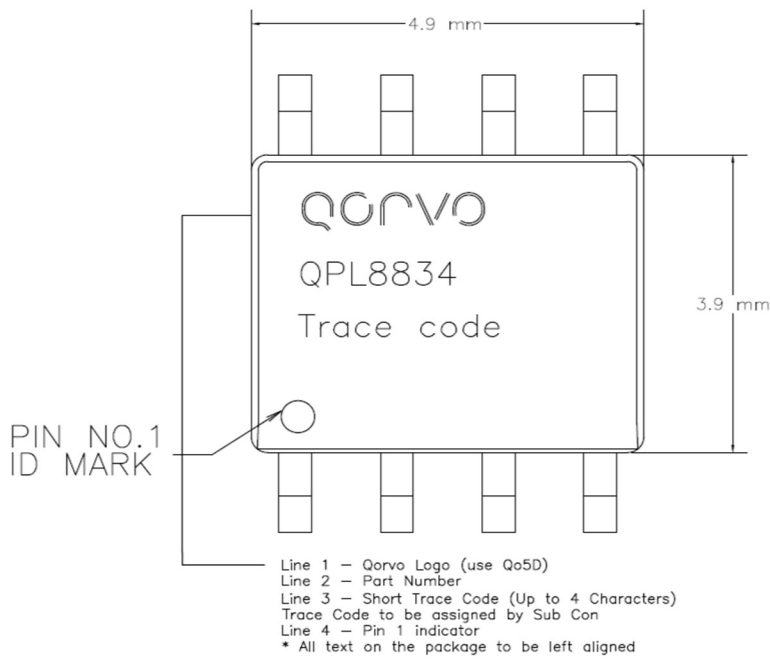

Pin Configuration and Description

Pin	Name	Description
1	RFIN1	RF input for plus side of the amplifier
2	LIN1	Linearizer Current Set for plus side of the amplifier
3	LIN2	Linearizer Current Set for minus side of the amplifier
4	RFIN2	RF input for minus side of the amplifier
5	RFOUT2	RF output for minus side of the amplifier
6	VG2	VG2 Adjust
7	ISSET	IDD Set
8	RFOUT1	RF output for plus side of the amplifier
9	GND	Exposed bottom of part, device ground

Package Outline

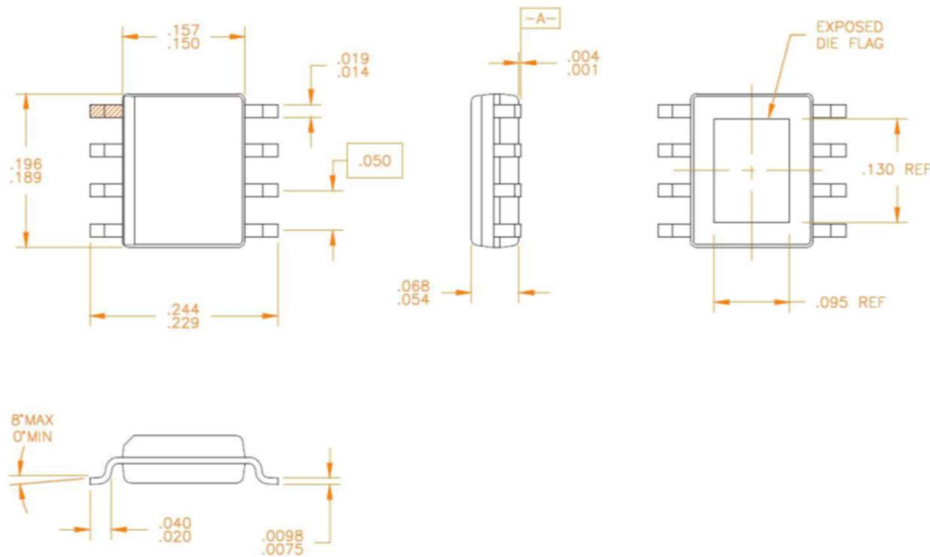

1. All dimensions are in inches. Angles are in degrees.

Notes:

1. All Dimensions are in inches.
2. Angles are in degrees.

Recommended Mounting Pattern

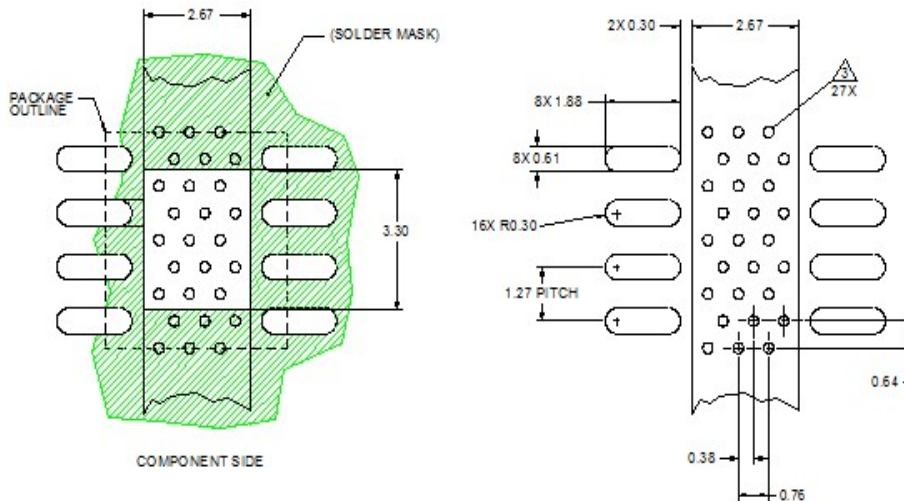

Notes: All dimensions are in millimeters. Angles are in degrees.

1. Use 1 oz. copper minimum for top and bottom layer metal.
2. Vias are required under the backside paddle for proper RF/DC grounding and thermal dissipation.
3. Recommend a 0.35 mm diameter bit for drilling via holes and a final plated thru diameter of 0.25 mm.