

Product Description

The QPM1002 is a Gallium Nitride MMIC front-end module (FEM) designed for X-Band radar applications within the 8.5 – 10.5 GHz range. The MMIC combines a T/R switch, low-noise amplifier, and a power amplifier. The receive path offers 24.5 dB gain with low noise figure of 2.2 dB. The transmit path offers a small signal gain of 33 dB, it can deliver 3 W of saturated power with a PAE of 32%, with a 25 dB of large signal gain. The FEM is robust up to 2 W of input power into the ANT port eliminating the need for a limiter.

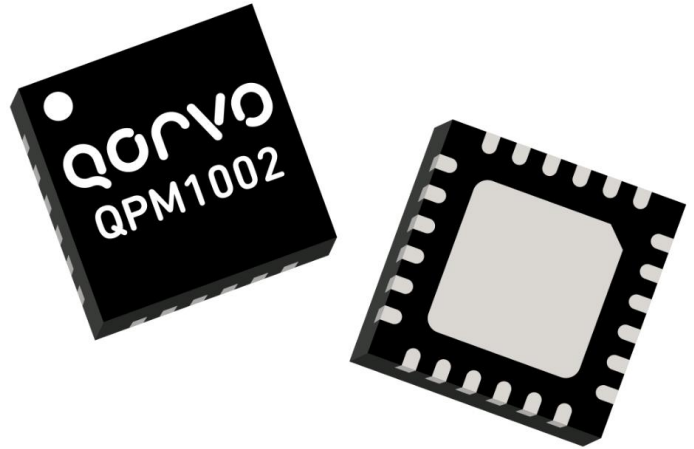

The QPM1002 is fabricated on Qorvo's QGaN25 0.25um GaN-on-SiC process. The 5 x 5 mm QFN surface mount package with over-mold encapsulant, coupled with high thermal conductivity die-attach process, allows the QPM1002 to perform well in a high temperature environment. Its compact size supports tight lattice spacing requirements needed for X-Band phased array radar applications.

Functional Block Diagram

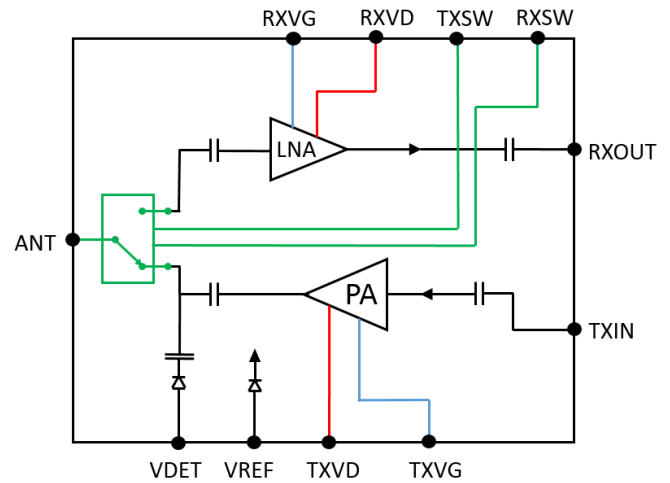

Product Features

- Frequency Range: 8.5 – 10.5 GHz
- RX Noise Figure: 2.2 dB
- RX Small Signal Gain: 24.5 dB
- RX Saturated Power: 16 dBm
- RX Output TOI: 22dBm
- TX Small Signal Gain: 33 dB
- TX Large Signal Gain: 25 dB
- TX Saturated Power: 34.5 dBm, Pulsed
- TX PAE: 32% @ 34.5 dBm Pout, Pulsed
- TX Output TOI @ 6 dBm Pin / tone: 38.5 dBm
- TX Harmonics Suppression: 35 dBc
- Package Dimensions: 5 x 5 x 0.85 mm

*Performance is typical at room temperature.
Please reference electrical specification table and data plots for more details.*

Applications

- Electronics Warfare (EW)
- Commercial and Military Radar
- Communications

Ordering Information

| Part No. | Description |
|-------------|---------------------------------|
| QPM1002 | QPM1002 Shipping Tray, Qty 250 |
| QPM1002SR | QPM1002 Tape and Reel, Qty 100 |
| QPM1002TR7 | QPM1002 Tape and Reel, Qty 750 |
| QPM1002EVB1 | QPM1002 Evaluation Board, Qty 1 |

Normal Operating Conditions

| Parameter | Value |
|---|--|
| RX Drain Voltage (RXVD) ^{1, 3} | 10 V |
| RX Drain Quiescent Current (RXIDQ) | 20 mA |
| RX Gate Control (RXVG) ² | -2.5 V |
| TX Drain Voltage (TXVD) | 25 V |
| TX Drain Quiescent Current (TXIDQ) | 110 mA |
| TX Gate Voltage (TXVG) ² | -2.5 V |
| Control Voltage (TXSW / RXSW) | Transmit: -28V / 0 V; Receive: 0V / -28V |
| Operating Temperature Range | -40 to 95 °C |

1. Electrical specifications are measured at specified test conditions. Specifications are not guaranteed over all recommended operating conditions.
2. Gate voltage shown are typical, can be adjusted to set required drain current.
3. Drain of LNA is switched off by internal switch when in transmit mode. In receive mode, the PA should be biased off.

Absolute Maximum Ratings

| Parameter | Value |
|--------------------------------------|---------------|
| Drain Voltage (TXVD and RXVD) | 32 V |
| Drain Current (TXID) | 600 mA |
| Drain Current (RXID) | 60 mA |
| Gate Voltage (RXVG, TXVG) | 0 to -5 V |
| Gate Current (RXIG) | 10 mA |
| Gate Current (TXIG) | 20 mA |
| Switch Control Voltage (TXSW, RXSW) | 0 to -50 V |
| Switch Control Current | 20 mA |
| RF Input Power (All RF ports, 85 °C) | 33 dBm |
| Channel Temperature, T _{CH} | 225 °C |
| Mounting Temperature (30 seconds) | 260 °C |
| Storage Temperature | -55 to 150 °C |

Operation of this device outside the parameter ranges given above may cause permanent damage. These are stress ratings only, and functional operation of the device at these conditions is not implied.

Electrical Specifications, Receive

Test conditions unless otherwise noted: RXVD = 10 V, RXIDQ = 20 mA, RXSW = - 28 V, TXSW = 0 V, Transmit channel biased off.
Data de-embedded to device reference plane, 25 °C

| Parameter | Min | Typical | Max | Units |
|--|-------|---------|------|-------|
| Frequency | 8.5 | | 10.5 | GHz |
| Small Signal Gain | 21 | 24.5 | 28.5 | dB |
| Noise Figure | | 2.2 | | dB |
| Input Return Loss | | 13 | | dB |
| Output Return Loss | | 12 | | dB |
| Saturated Output Power, CW Mode | | 16 | | dBm |
| Output TOI @ -31 dBm Pin / Tone, CW Mode | | 22 | | dBm |
| Gate Leakage Current (RXVG leak, RXVD = 10 V, RXVG = -3.7 V) | -0.44 | 0 | | mA |
| Switch Settling Time, Rising Edge ¹ | | | 20 | nS |
| Switch Settling Time, Falling Edge ² | | | 100 | nS |
| Gain Temperature Coefficient | | -0.04 | | dB/°C |

- ¹ From 50% trigger signal to 90 % of RF on (Trigger signal to switch driver to DUT).
² From 50% trigger signal to 10 % of RF off (Trigger signal to switch driver to DUT).

Electrical Specifications, Transmit

Test conditions unless otherwise noted: TXVD = 25 V, TXIDQ = 110 mA, RXSW = 0V, TXSW = - 28 V
Data de-embedded to device reference plane, 25 °C

| Parameter | Min | Typical | Max | Units |
|--|--------|---------|------|-------|
| Frequency | 8.5 | | 10.5 | GHz |
| Small Signal Gain | | 33 | | dB |
| Large Signal Gain | | 25 | | dB |
| Input Return Loss | | 15 | | dB |
| Output Return Loss | | 15 | | dB |
| Saturated Output Power @ 8.5 GHz to 9.5 GHz ¹ | 32.5 | 34.5 | | dBm |
| Saturated Output Power @ 10 GHz ¹ | 31.5 | 34.5 | | dBm |
| Saturated Output Power @ 10.5 GHz ¹ | 31.0 | 34.5 | | dBm |
| PAE at Saturated Power (@ 10 dBm Pin) ¹ | | 32 | | % |
| Output TOI @ 6 dBm Pin / tone, CW Mode | | 38.5 | | dBm |
| Harmonic Suppression, CW Mode | | 35 | | dBc |
| Power Detection Output (VREF – VDET) | 0 | | 0.5 | V |
| Gate Leakage Current (TXVG leak, TXVD = 10 V, TXVG = -3.7 V) | - 2.37 | 0 | | mA |
| Switch Settling Time, Rising Edge ² | | | 40 | nS |
| Switch Settling Time, Falling Edge ³ | | | 60 | nS |
| Gain Temperature Coefficient | | -0.05 | | dB/°C |

- ¹ Power and PAE measured with DC drain pulsed, PW = 100 uS, Duty Cycle = 10%.
² From 50% trigger signal to 90 % of RF on (Trigger signal to switch driver to DUT)
³ From 50% trigger signal to 10 % of RF off (Trigger signal to switch driver to DUT)

Small Signal Performance, Receive

Test Conditions unless otherwise stated: RXVD = 10 V, RXIDQ = 20 mA, RXSW = -28 V, TXSW = 0 V, 25 °C
Transmit channel biased off.

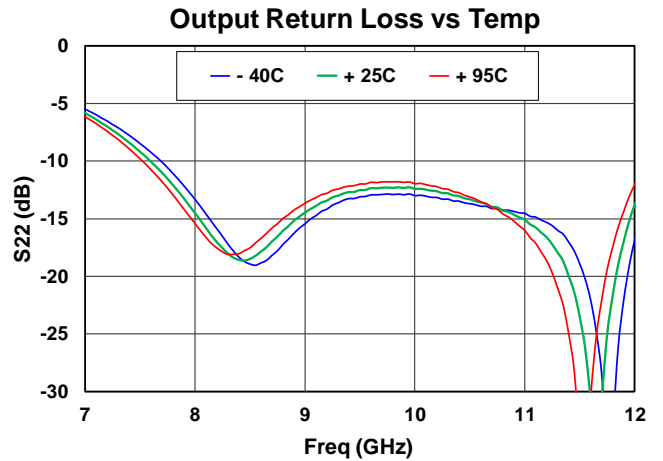
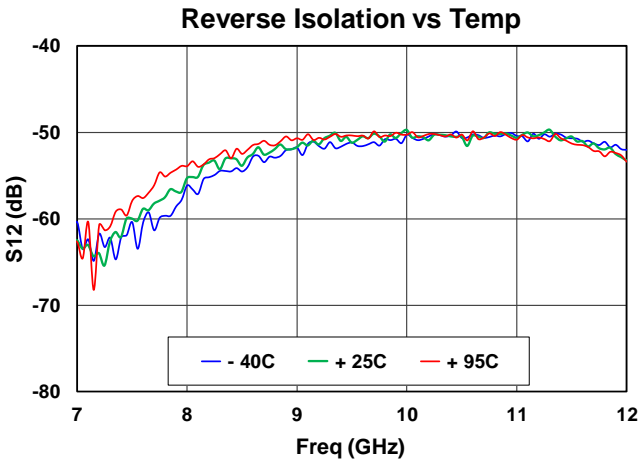
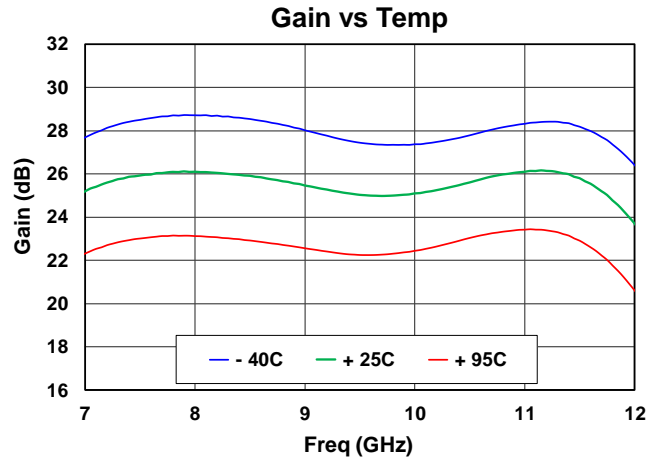
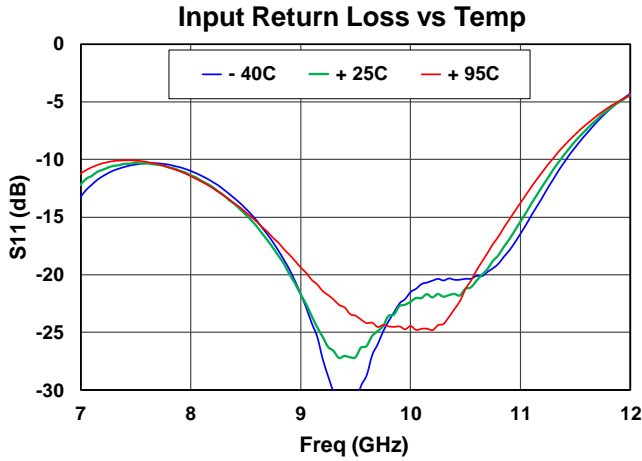

Small Signal Performance, Receive

Test Conditions unless otherwise stated: RXVD = 10 V, RXIDQ = 20 mA, RXSW = -28 V, TXSW = 0 V, 25 °C
Transmit channel biased off.

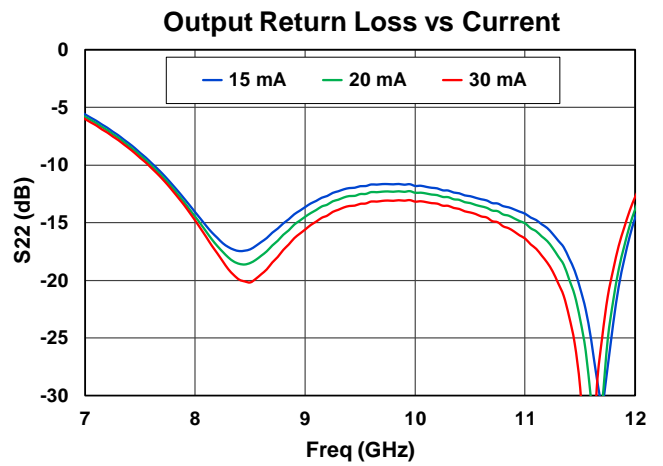
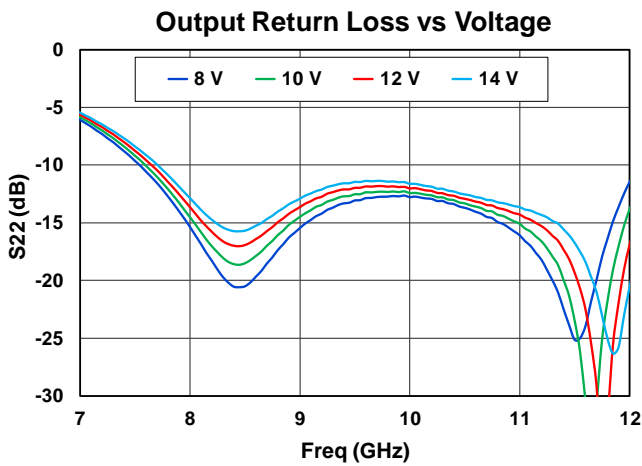
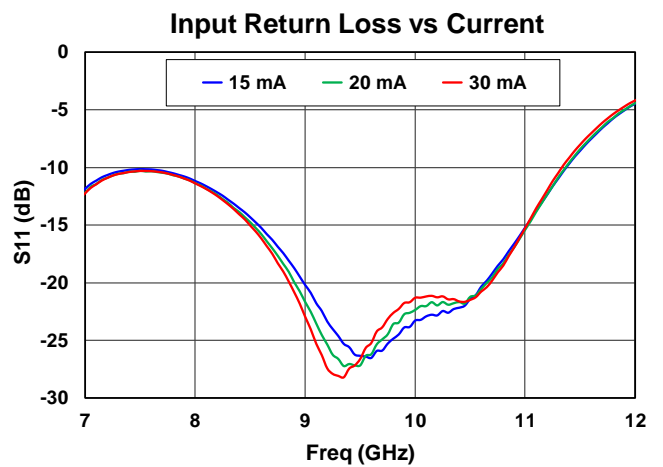
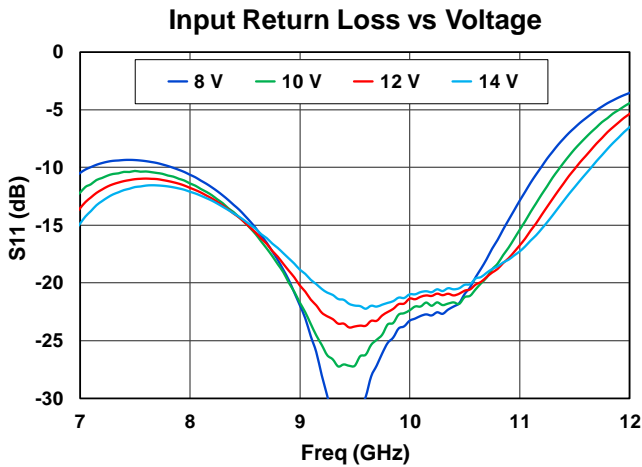
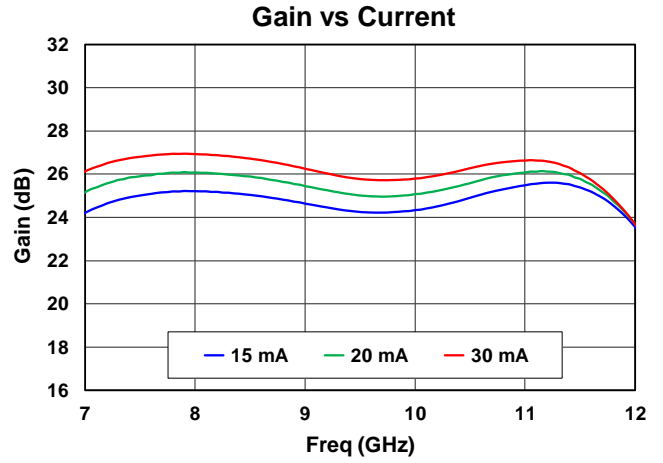
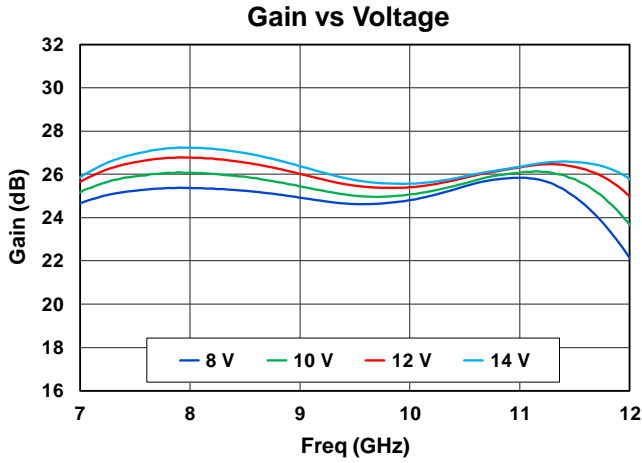

Noise Figure and Isolation

Test Conditions unless otherwise stated: VD = 10 V, RXIDQ = 20 mA, RXSW = -28 V, TXSW = 0 V, 25 °C
Transmit channel biased off.

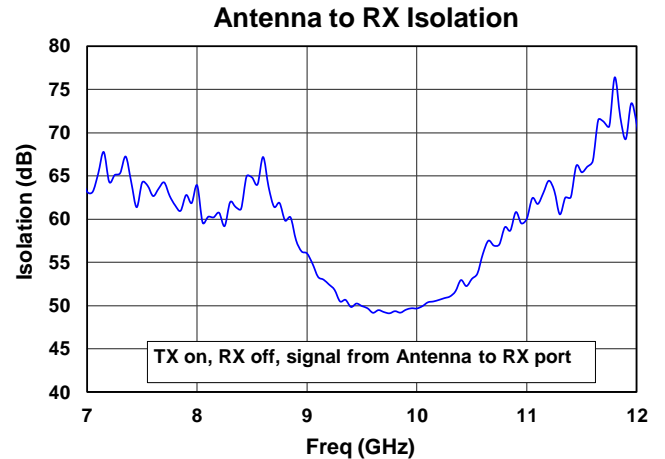
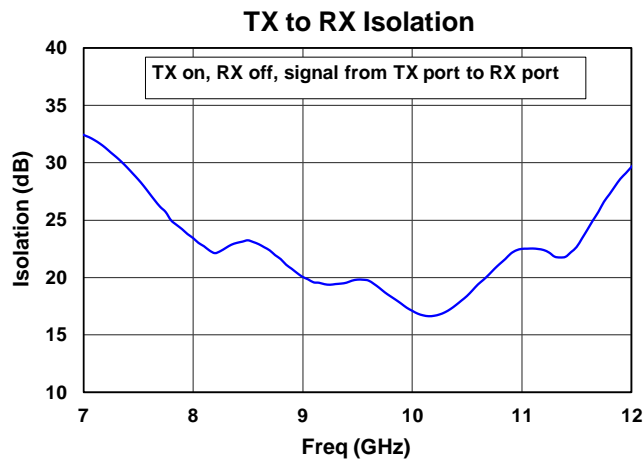
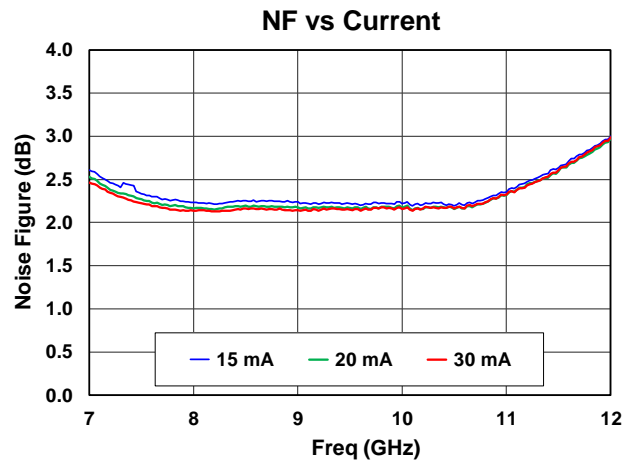
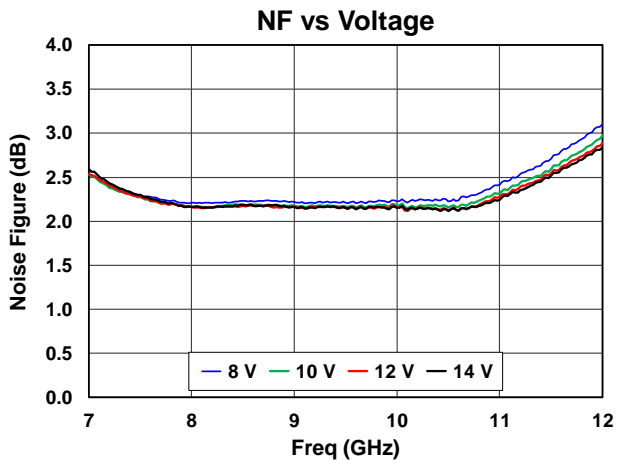
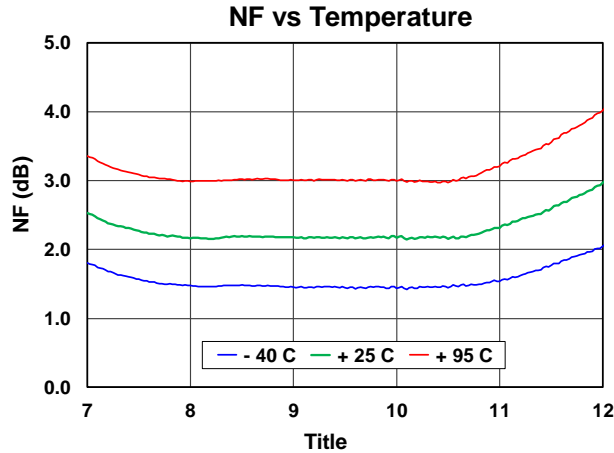

Power Performance, Receive

Test Conditions unless otherwise stated: $V_D = 10\text{ V}$, $RXIDQ = 20\text{ mA}$, $RXSW = -28\text{ V}$, $TXSW = 0\text{ V}$
CW Mode, $P_{in} = 5\text{ dBm}$, transmit channel biased off., $25\text{ }^\circ\text{C}$

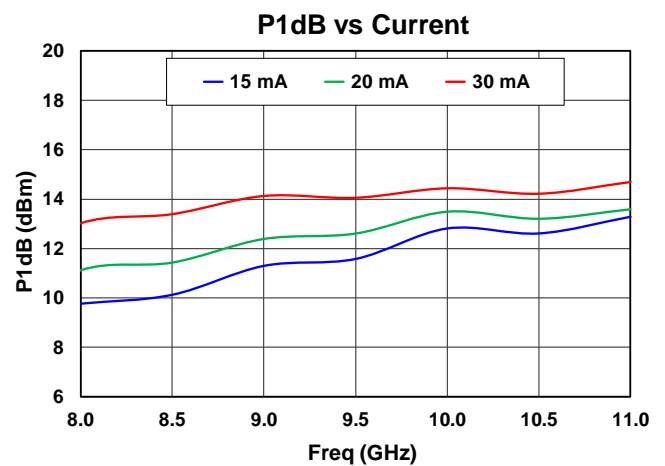
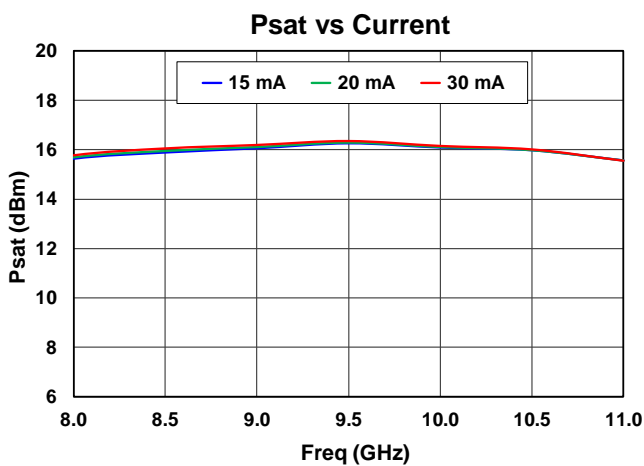
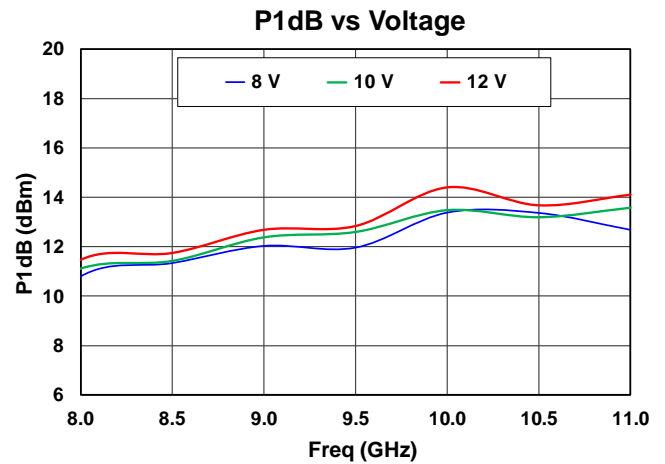
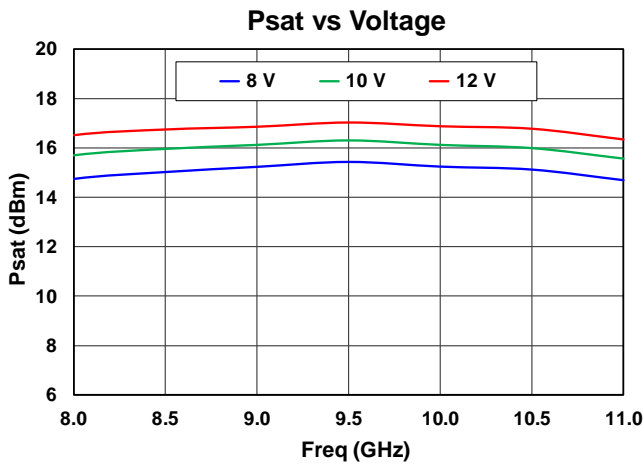
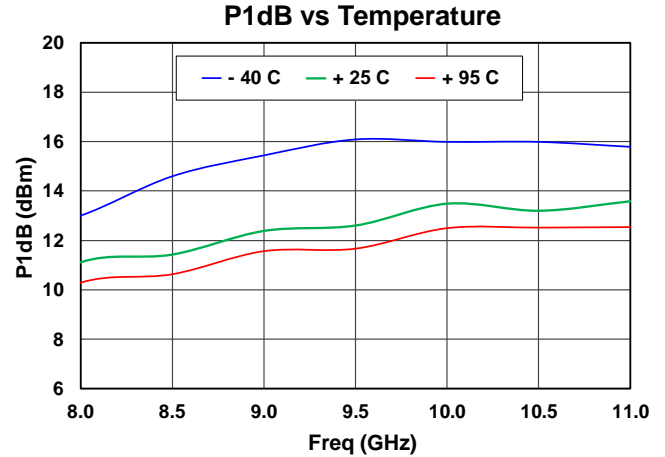
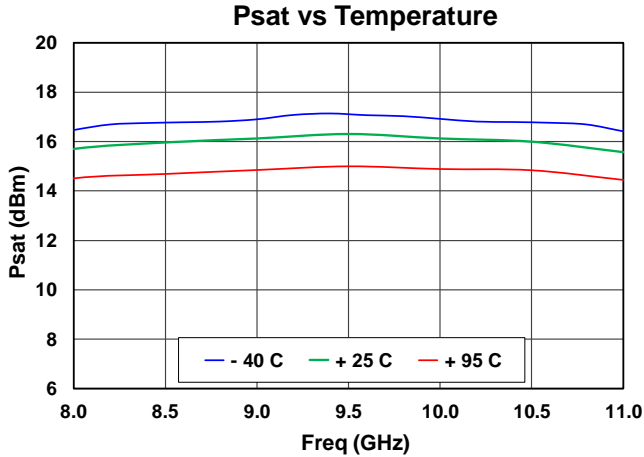

Power Sweep, Receive

Test Conditions unless otherwise stated: $V_D = 10\text{ V}$, $R_{XIDQ} = 20\text{ mA}$, $R_{XSW} = -28\text{ V}$, $T_{XSW} = 0\text{ V}$
CW Mode, transmit channel biased off, $25\text{ }^\circ\text{C}$

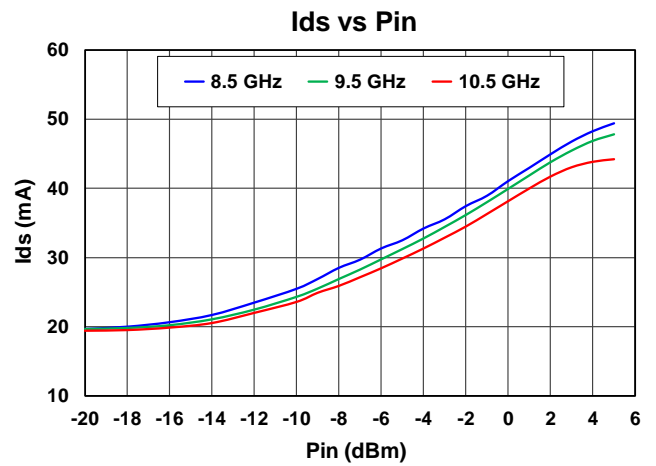
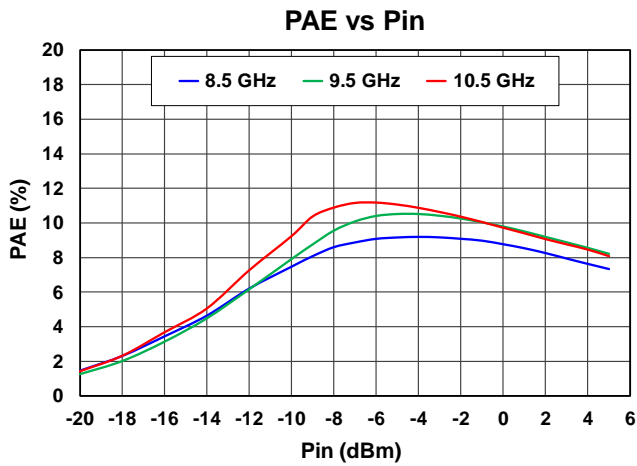
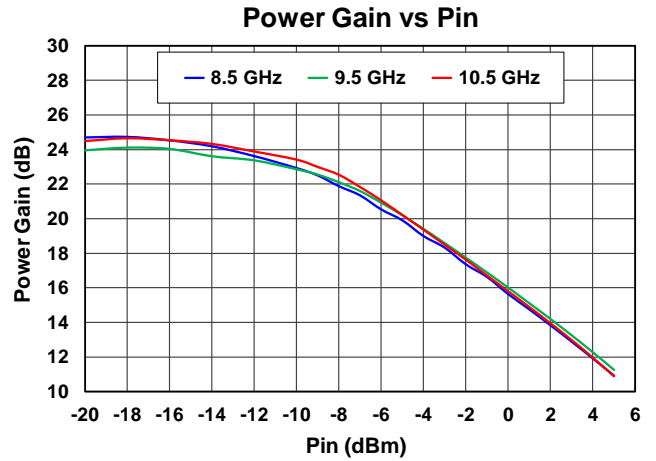
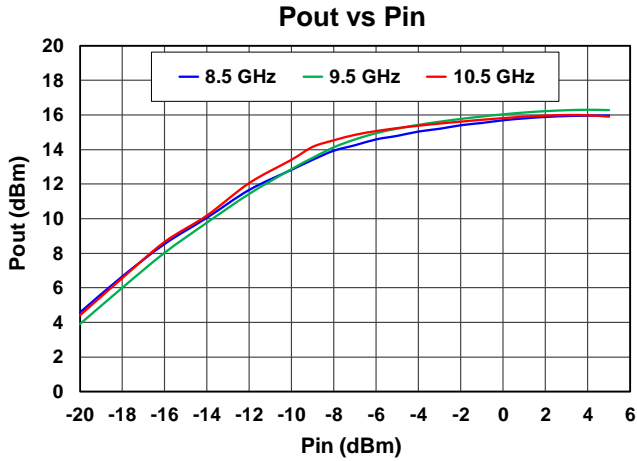

Linearity, Receive

Test Conditions unless otherwise stated: Transmit channel biased off, 25 °C
VD = 10 V, RXIDQ = 20 mA, RXSW = -28 V, TXSW = 0 V, CW Mode, Tone spacing = 20 MHz.

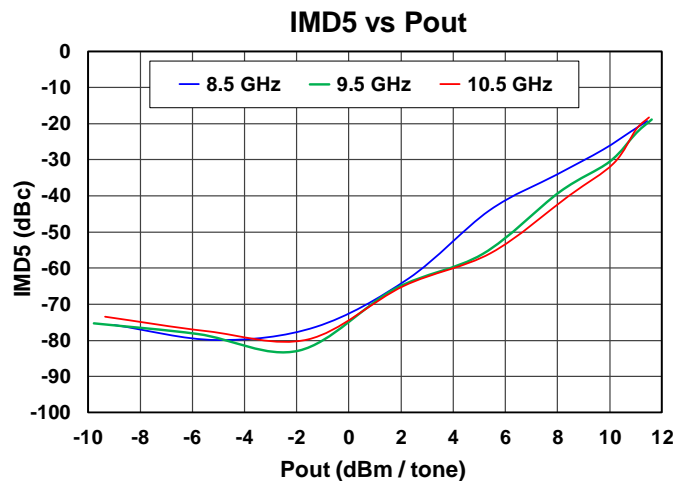
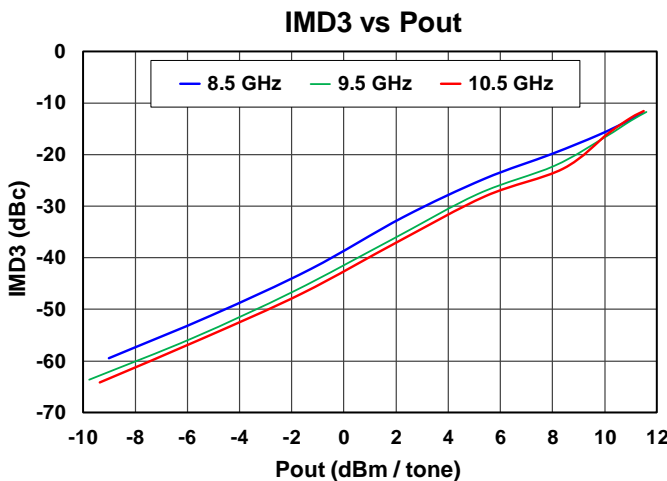
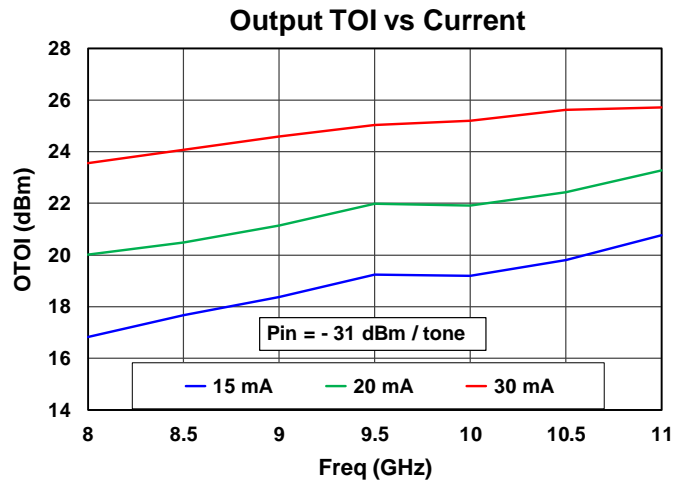
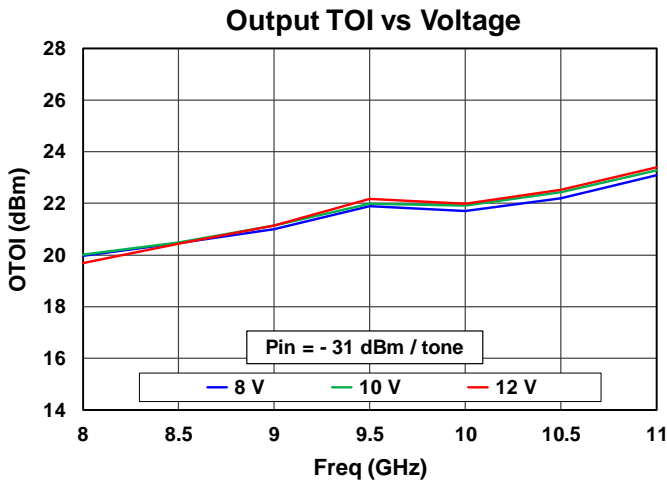
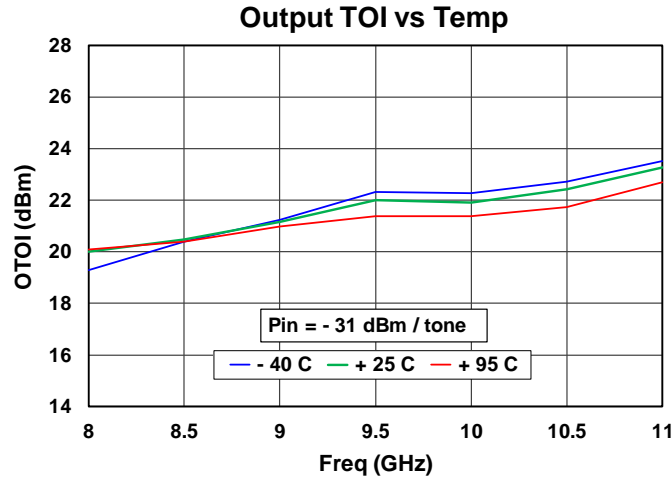

Small Signal Performance, Transmit

Test Conditions unless otherwise stated: TXVD = 25 V, TXIDQ = 110 mA, RXSW = 0V, TXSW = -28 V, 25 °C

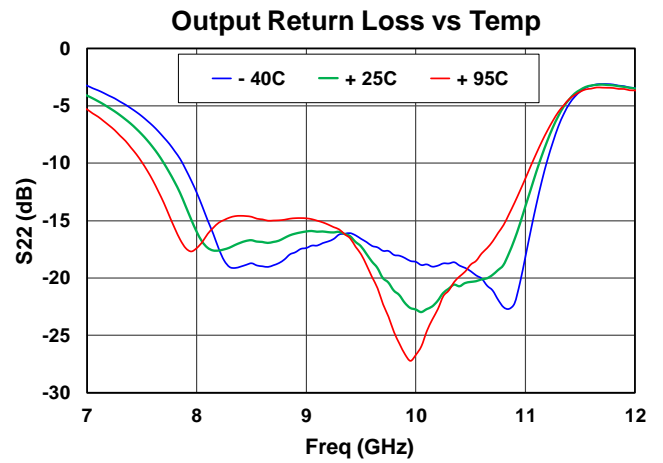
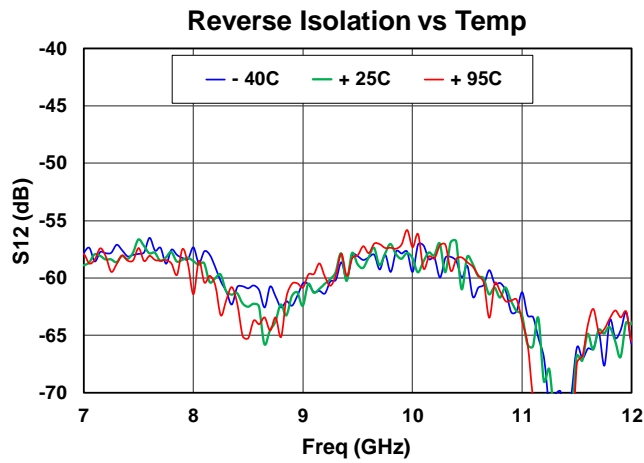
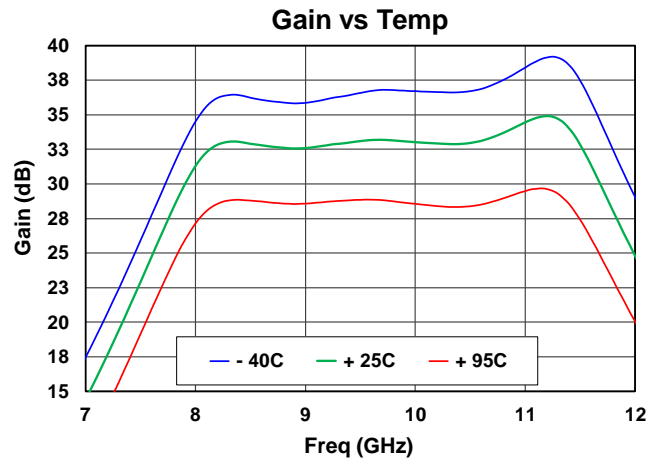
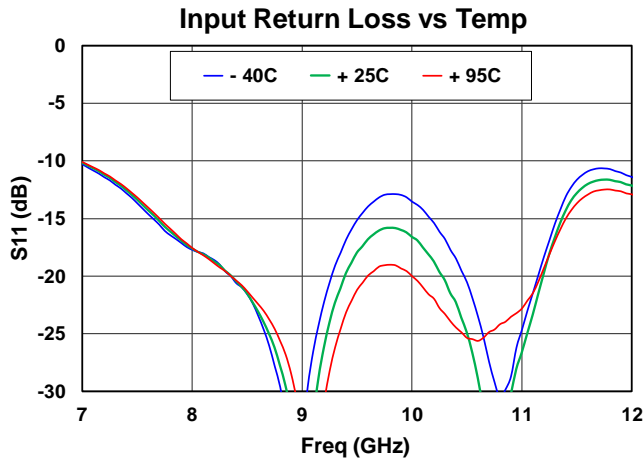

Small Signal Performance, Transmit

Test Conditions unless otherwise stated: VD = 25 V, TXIDQ = 110 mA, RXSW = 0V, TXSW = -28 V, 25 °C

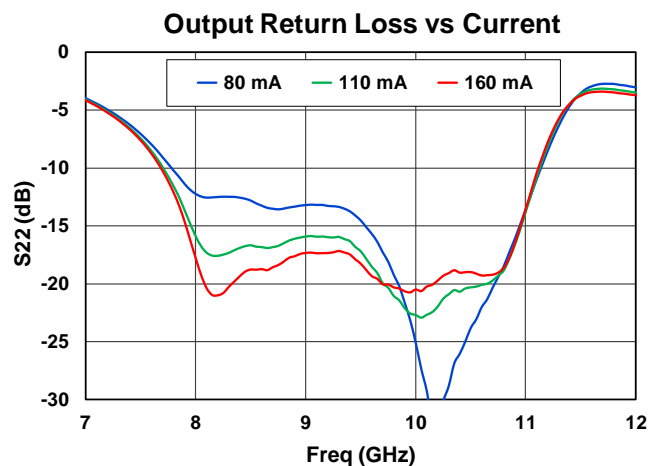
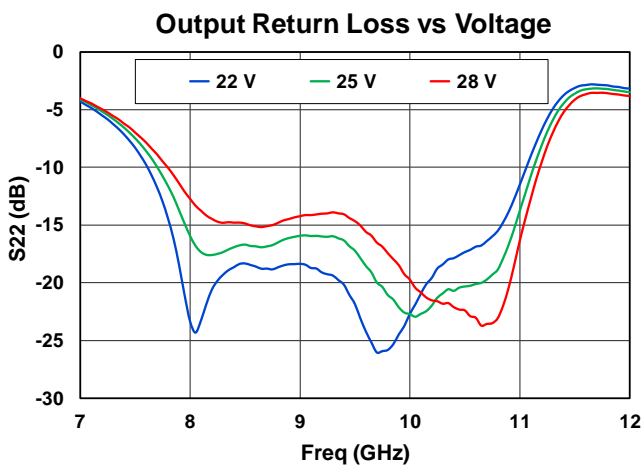
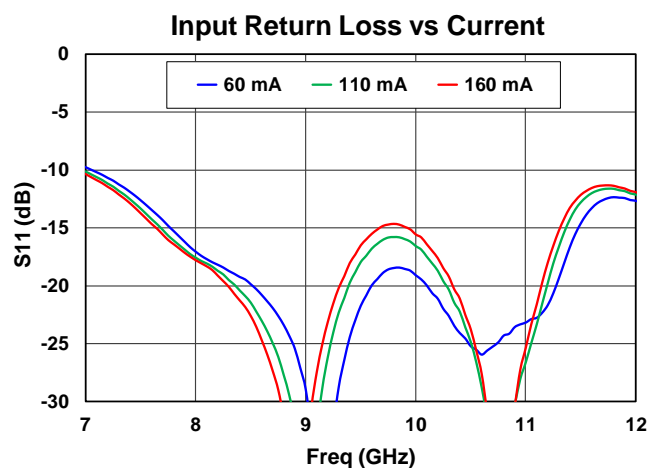
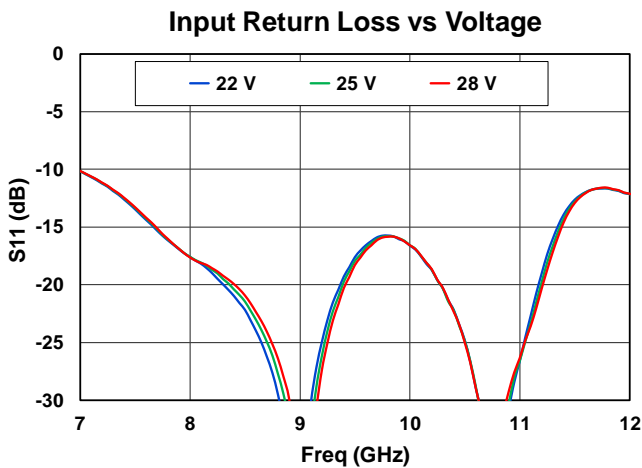
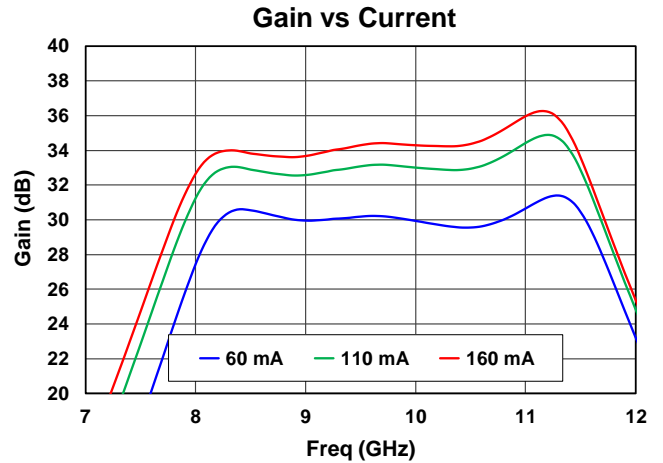
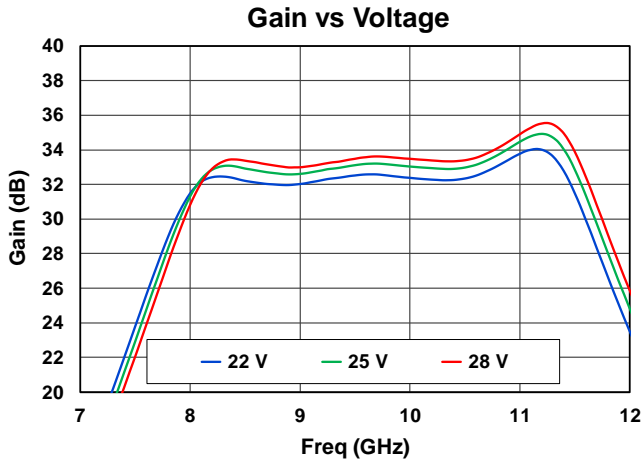

Power Performance, Transmit

Test Conditions unless otherwise stated: TXVD = 25 V, TXIDQ = 110 mA, RXSW = 0V, TXSW = -28 V
Pulse Mode, Pin = 16 dBm, PW = 100 uS, DC = 10%, 25 °C

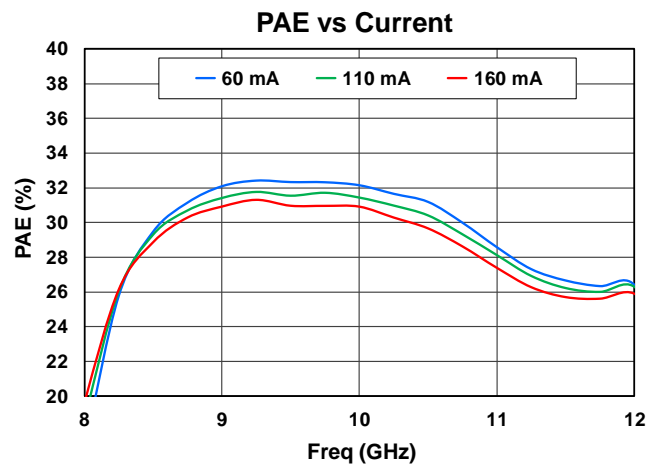
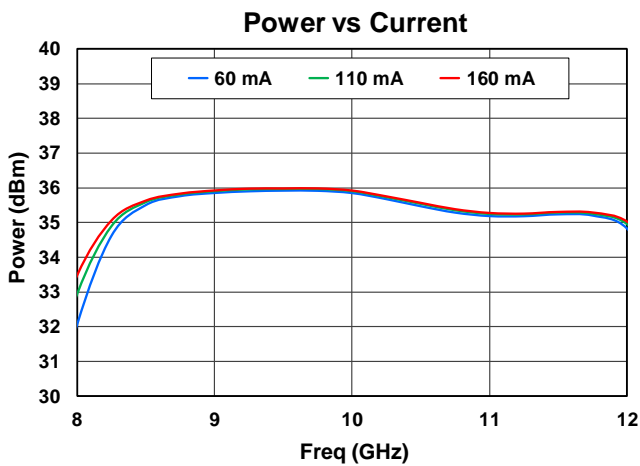
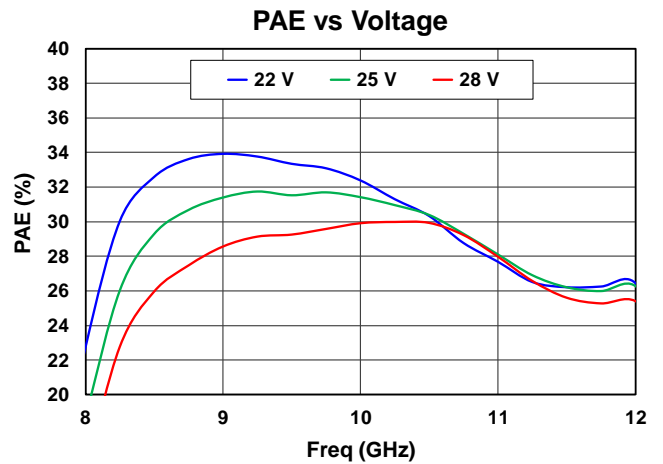
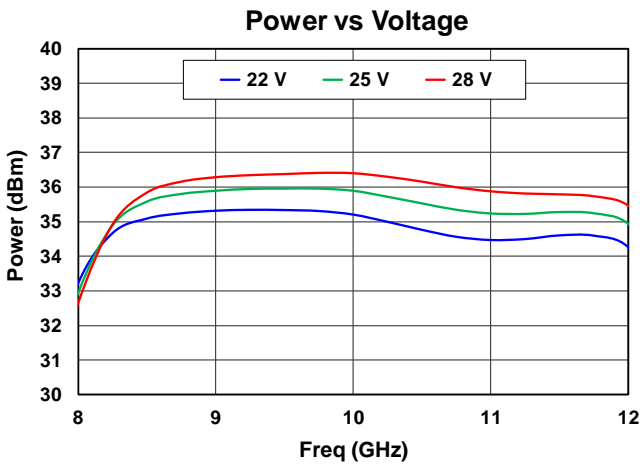
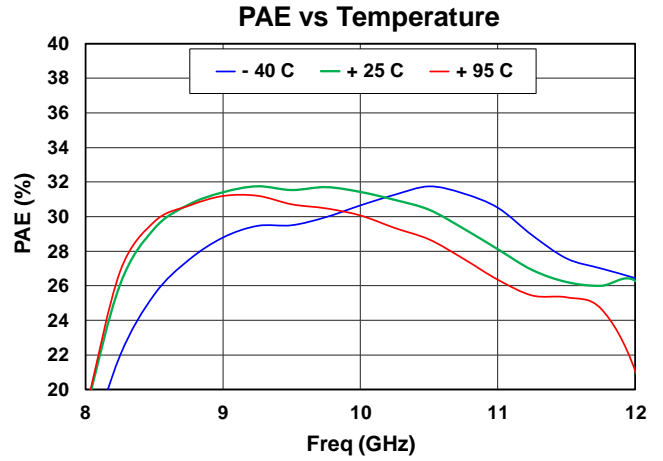
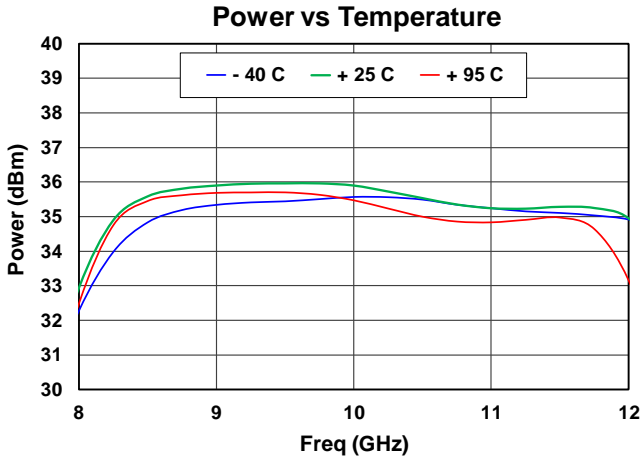

Power Performance, Transmit

Test Conditions unless otherwise stated: TXVD = 25 V, TXIDQ = 110 mA, RXSW = 0V, TXSW = -28 V
Pulse Mode, Pin = 10 dBm, PW = 100 uS, DC = 10%, 25 °C

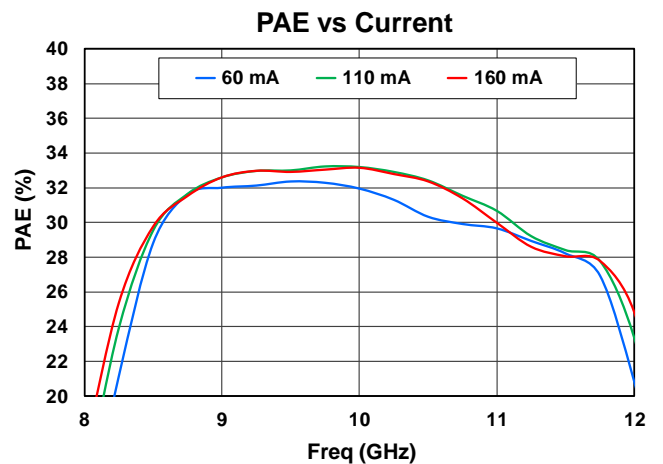
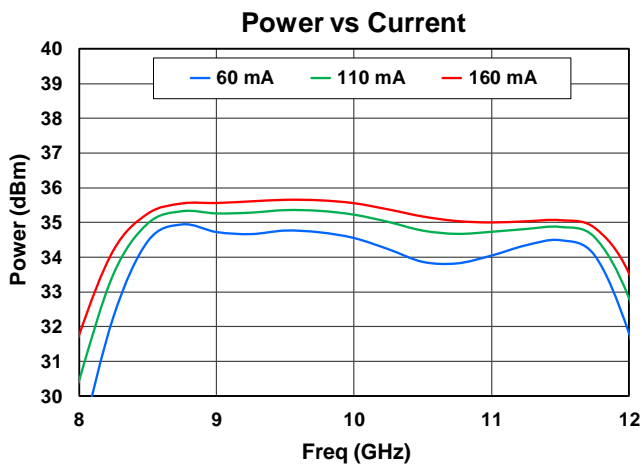
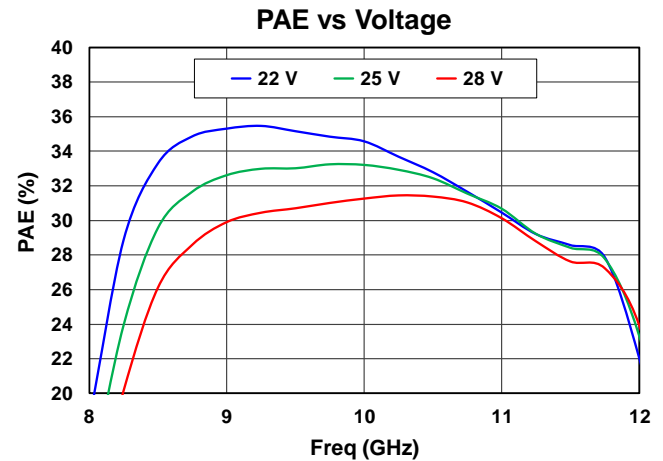
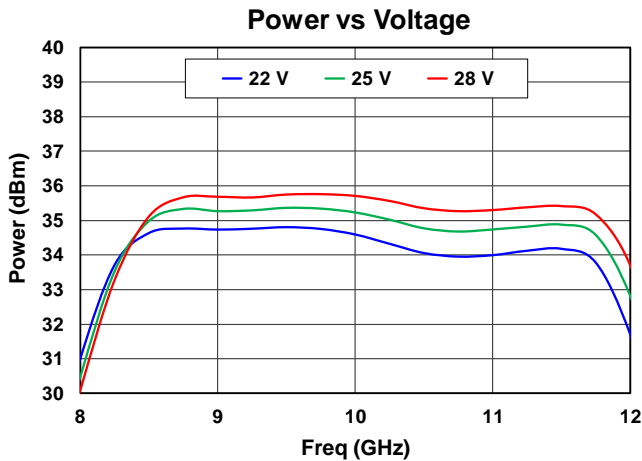
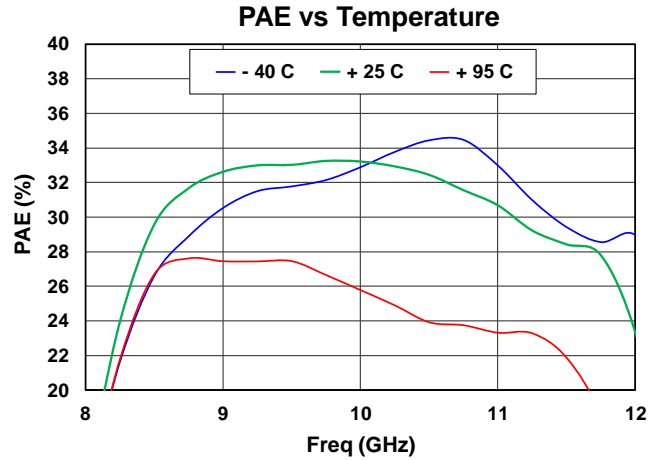
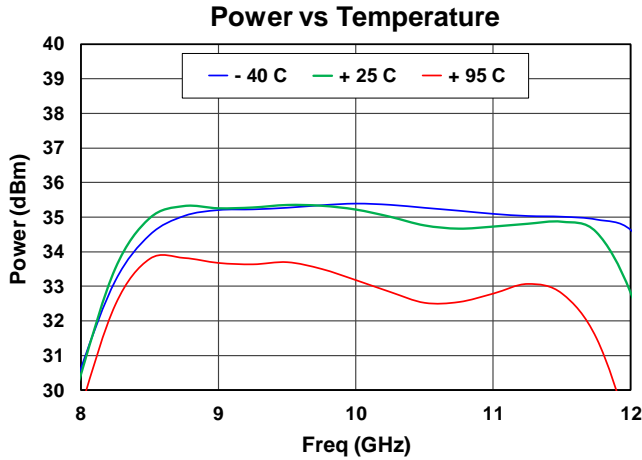

Power Performance, Transmit

Test Conditions unless otherwise stated: TXVD = 25 V, TXIDQ = 110 mA, RXSW = 0V, TXSW = -28 V
Pulse Mode, PW = 100 uS, DC = 10%, 25 °C

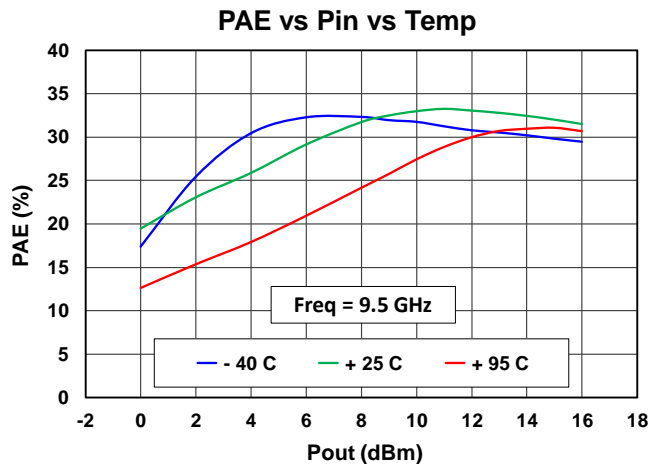
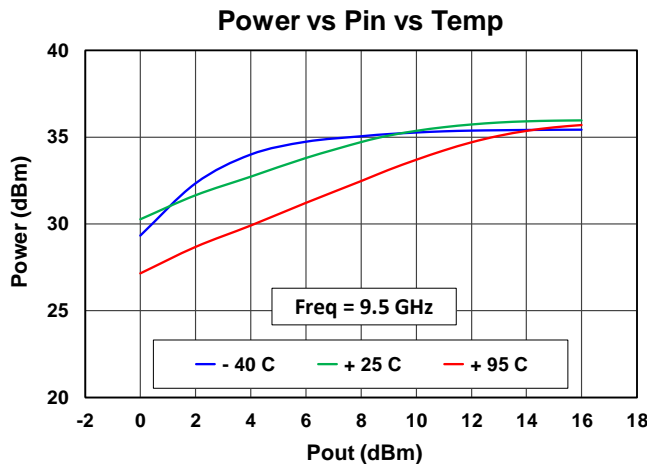
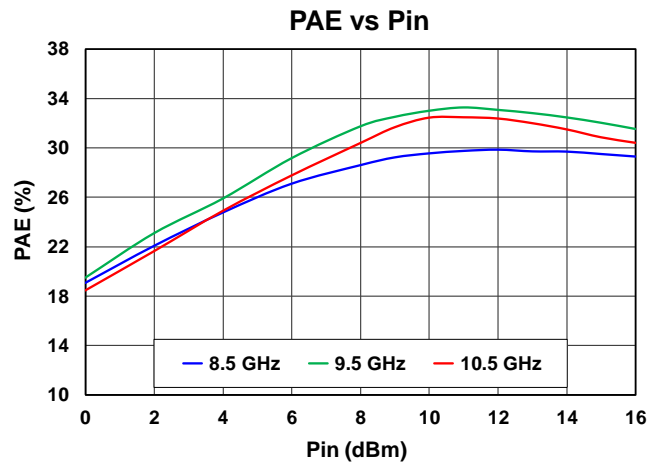
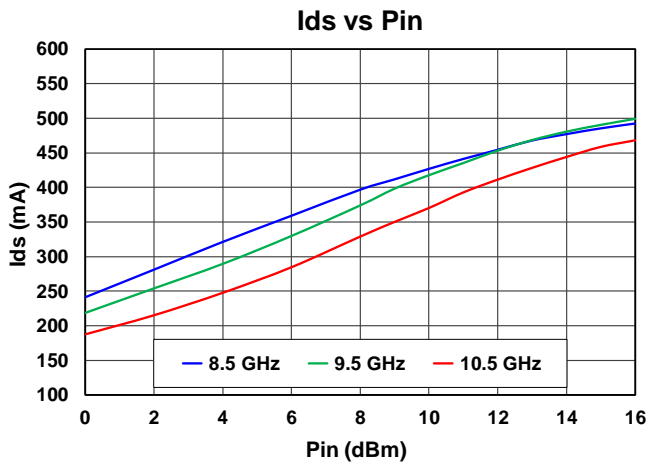
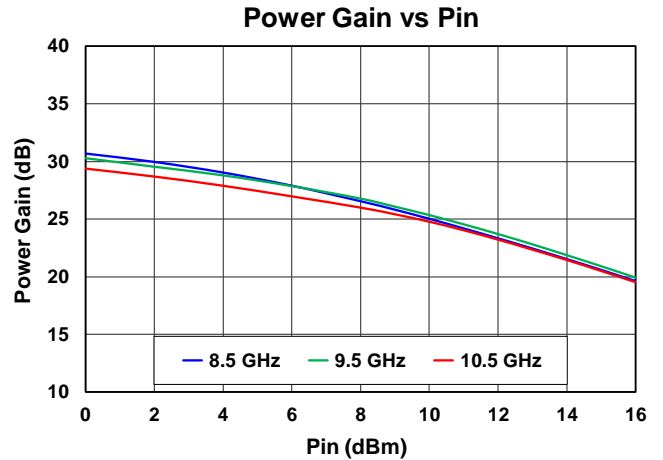
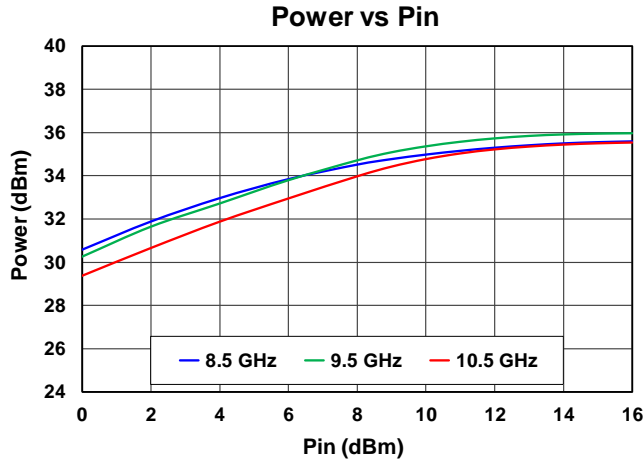

Power Performance, Transmit

Test Conditions unless otherwise stated: TXVD = 25 V, TXIDQ = 110 mA, RXSW = 0V, TXSW = -28 V
 Pulse Mode, PW = 100 uS, DC = 10%, 25 °C
 Detector Diodes are internally biased, Vout = VREF - VDET

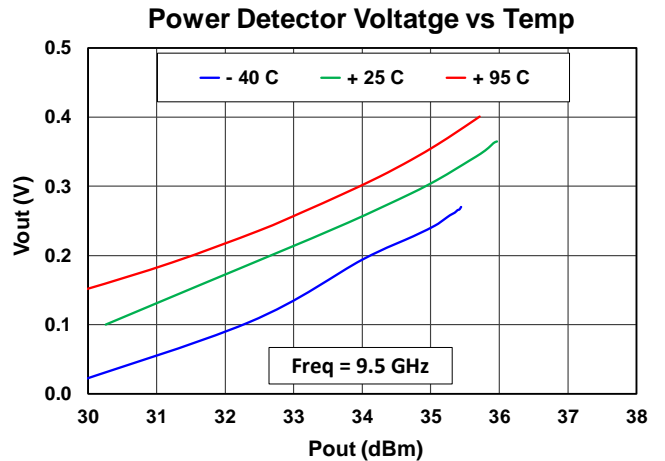
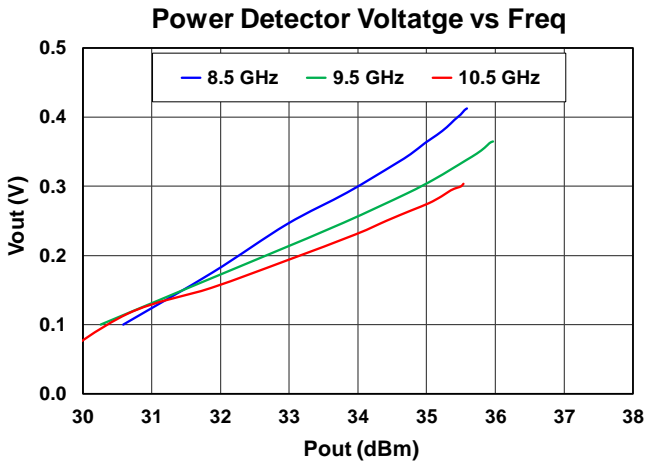
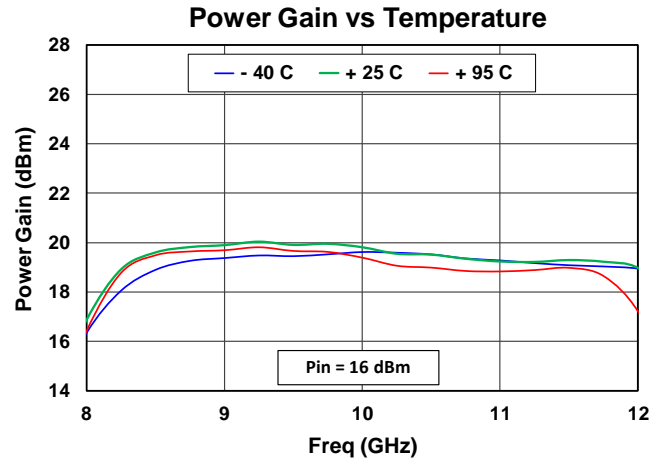
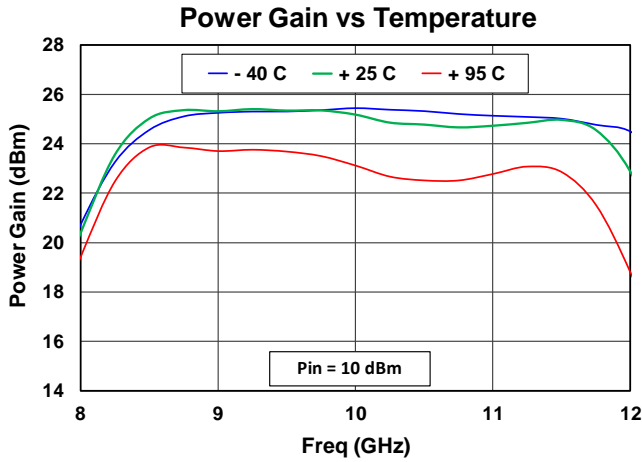

Linearity, Transmit

Test Conditions unless otherwise stated: 25 °C
TXVD = 25 V, TXIDQ = 110 mA, RXSW = 0V, TXSW = -28 V, CW Mode, Tone Spacing = 20 MHz

Output TOI vs Temp

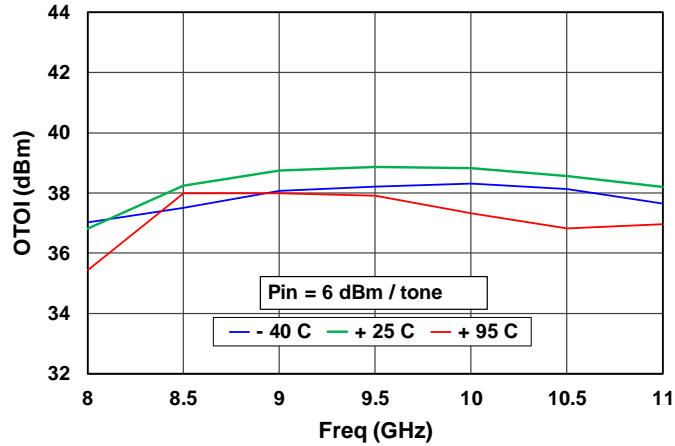

Output TOI vs Voltage

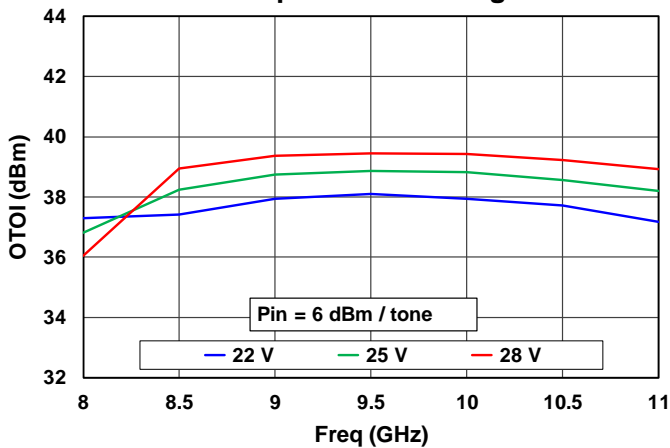

Output TOI vs Current

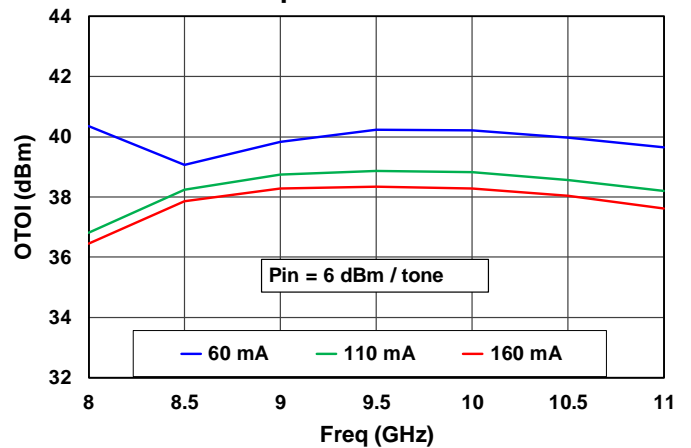

IMD3 vs Pout

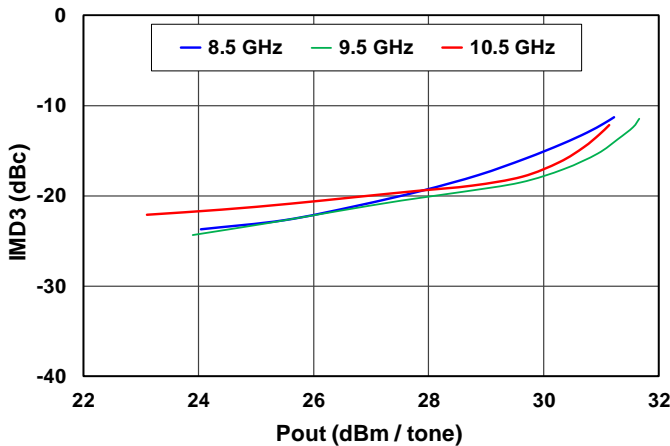

IMD5 vs Pout

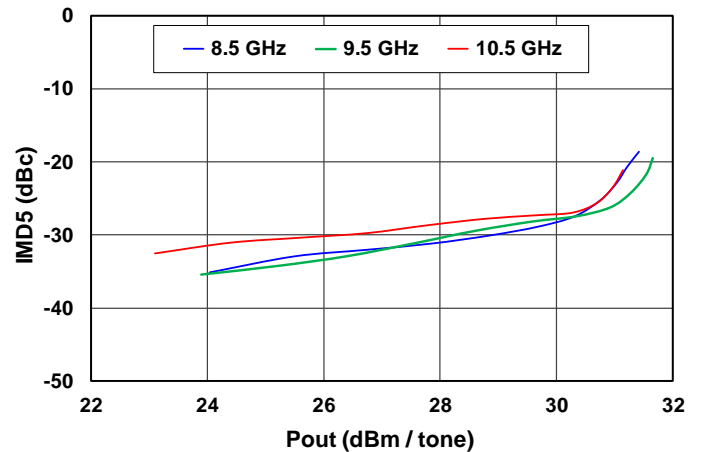

Harmonics, Transmit

Test Conditions unless otherwise stated: TXVD = 25 V, TXIDQ = 110 mA, RXSW = 0V, TXSW = -28 V, CW mode, 25 °C

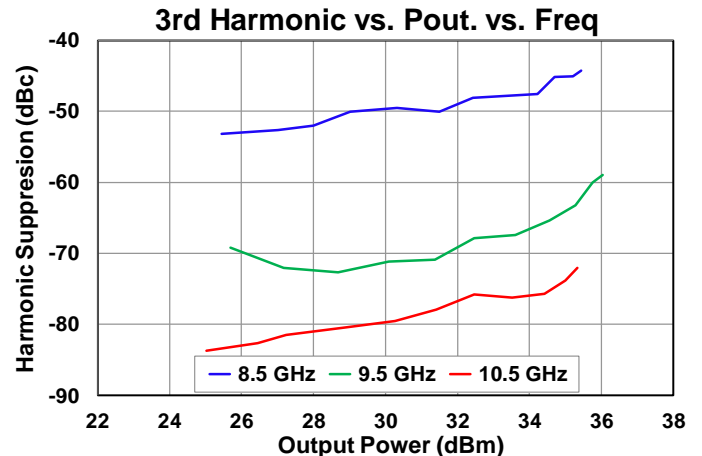
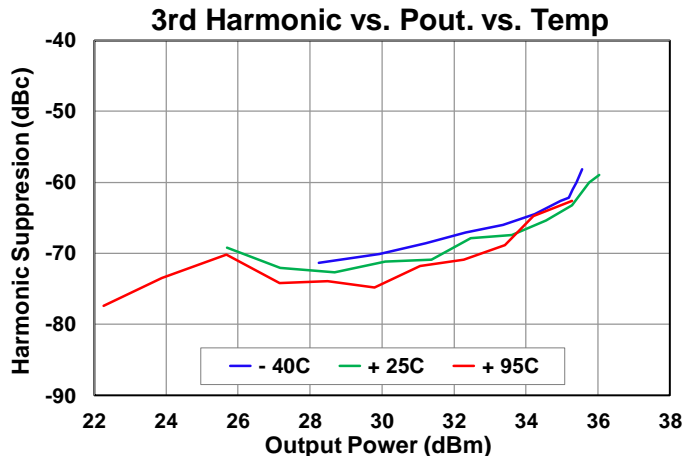
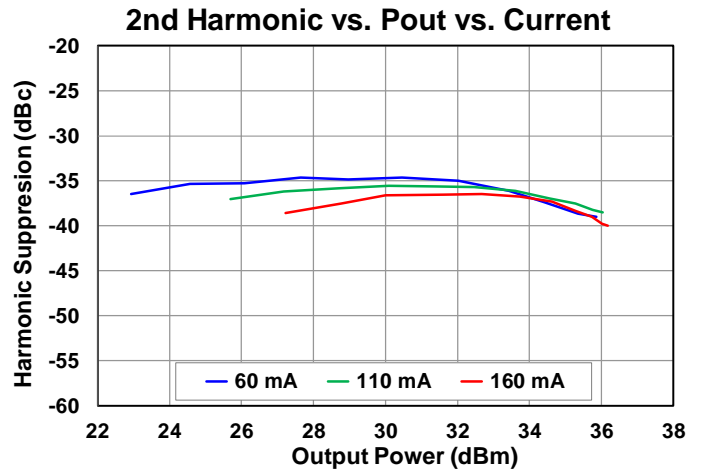
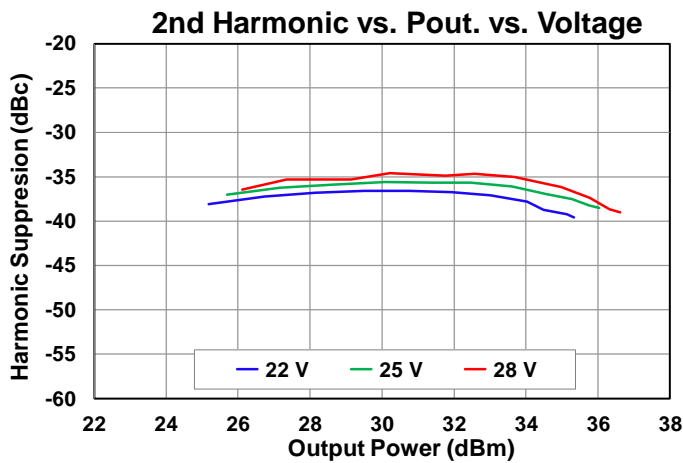
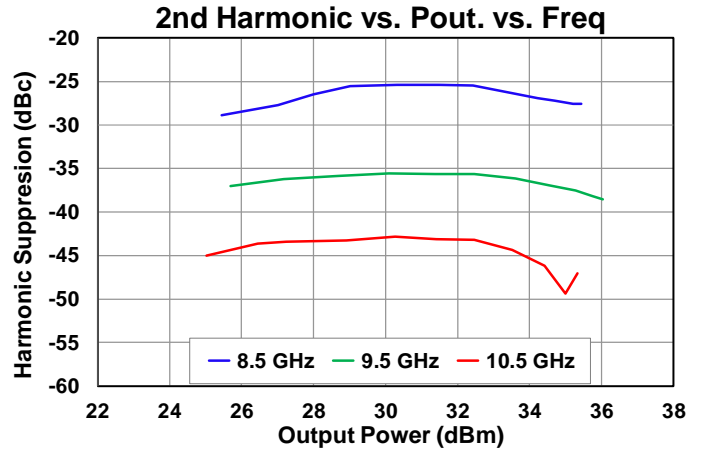
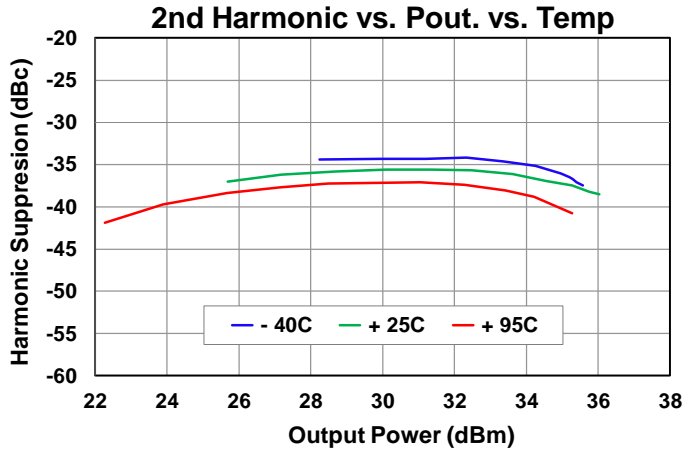

Application Circuit

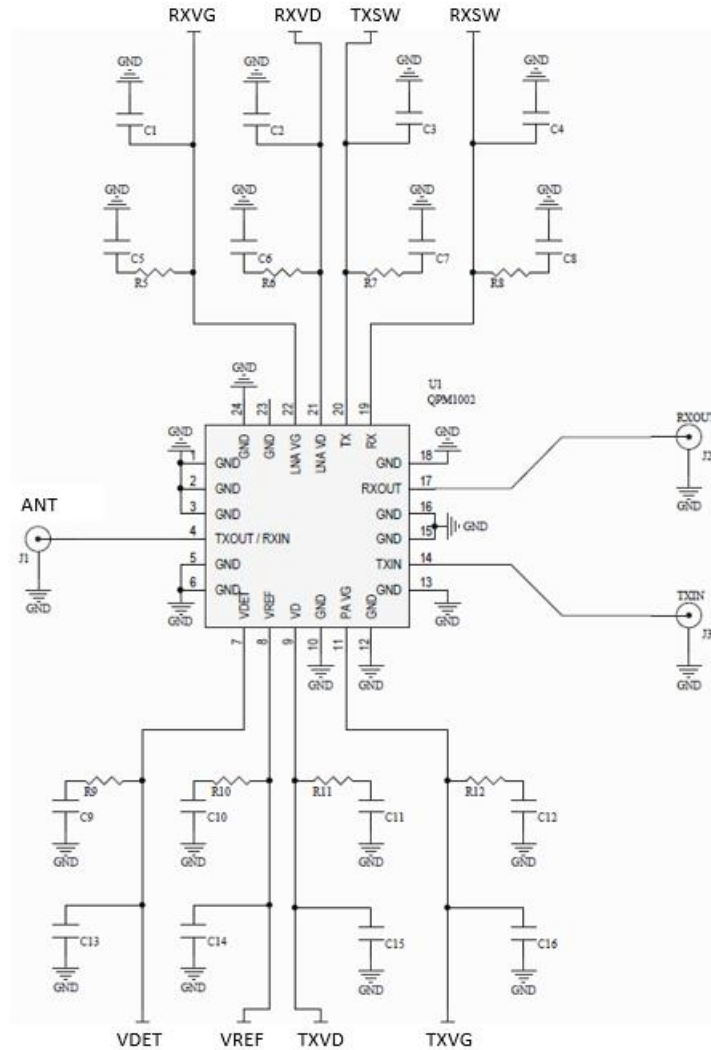

Bias-up Procedure

1. Set TXVD current limit to 600 mA, RXVD current limit to 60mA, gate current limit to 10 mA, switch control current limit to 10mA
2. Set RXVG and TXVG to - 5 V
3. Set TXSW = - 28 V (or 0 V), RXSW = 0 V (or - 28 V) for Transmit (Receive)
4. Set RXVD = + 10 V, TXVD = + 25 V (when in receive mode, should either set TXVG = -5 V, or TXVD off).
5. Adjust TXVG, RXVG to achieve required drain current for TX and RX (-2.5 V Typical)
6. Apply RF signal

Bias-down Procedure

1. Turn off RF signal
2. Set RXVG, TXVG to -5 V
3. Set RXVD = 0 V, TXVD = 0 V
4. Turn off drain supply
5. Turn off TXSW, RXSW
6. Turn off gate supply

Mechanical Drawing & Pad Description

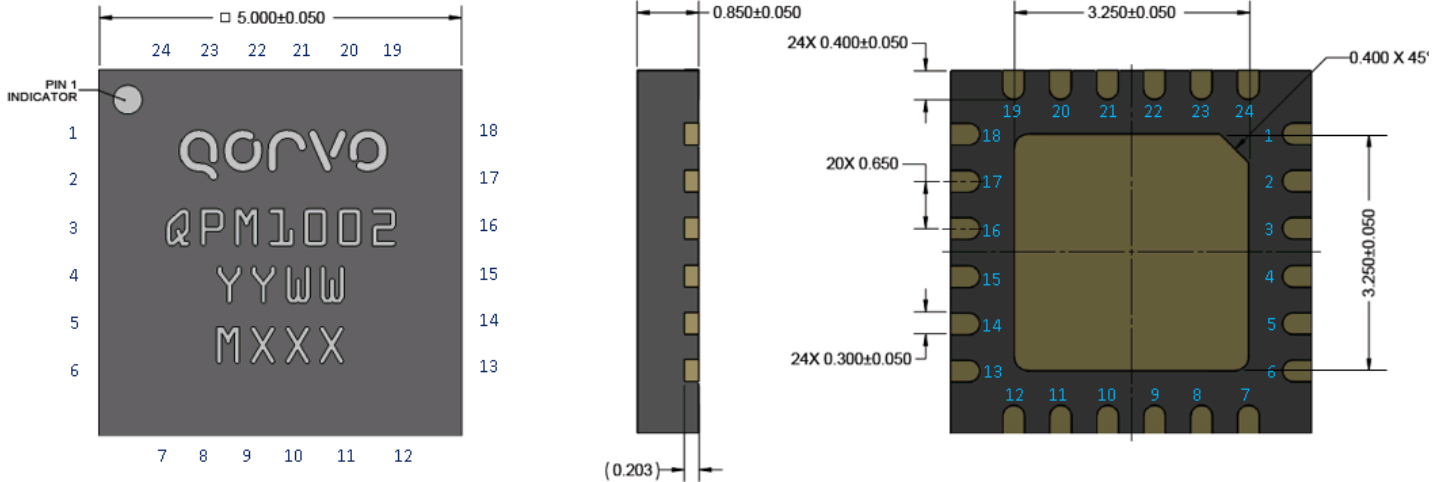

Dimensions in mm, package is mold encapsulated with gold plated leads
 Part Marking: QPM1002 = Part Number
 YY = Part Assembly Year, WW = Part Assembly Week, MXXX = Batch ID

| Pin Number | Label | Description |
|---|-------|-----------------------------|
| Slug | GND | GROUND |
| 4 | ANT | Common Port to Antenna |
| 7 | VDET | PA Power Detector |
| 8 | VREF | PA Power Detector Reference |
| 9 | TXVD | Transmit Drain Supply |
| 11 | TXVG | Transmit Gate Control |
| 14 | TXIN | Transmit Input |
| 17 | RXOUT | Receive Output |
| 19 | RXSW | Receive Switch Control |
| 20 | TXSW | Transmit Switch Control |
| 21 | RXVD | Receive Drain Supply |
| 22 | RXVG | Receive Gate Control |
| 1, 2, 3, 5, 6, 10, 12, 13, 15, 16, 18, 23, 24 | N/C | No Internal Connections |

Evaluation Board and Assembly

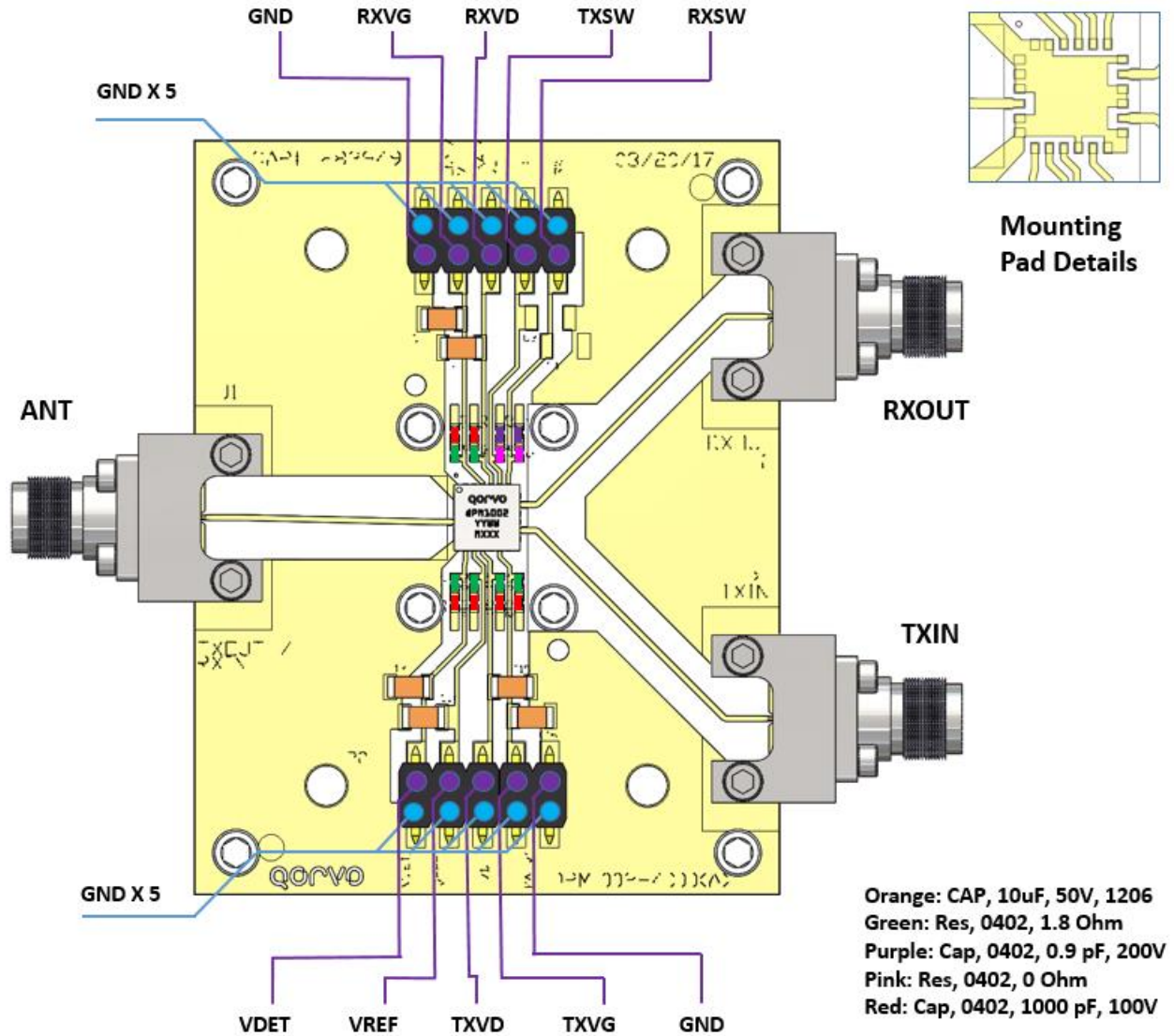

RF Layer is 0.008" thick Rogers Corp. RO4003C ($\epsilon_r = 3.35$). Metal layers are 0.5 oz. copper. The microstrip line at the connector interface is optimized for the Southwest Microwave end launch connector 1092-01A-5.

| Ref. Des. | Component | Value | Manuf. | Part Number |
|-------------------|-----------|---------------------------------------|---------|-------------|
| C5, C6, C9 - C12 | SMT Cap. | CAP, 0402 1000pF +/-10% 100V X7R ROHS | Various | |
| C1, C2, C13 - C16 | SMT Cap. | CAP, 1206 10uF +/-10% 50V X7R | Various | |
| R5, R6, R9 - R12 | SMT Res. | RES, 0402 1.8 OHM, 5% 1/10W | Various | |
| R7, R8 | SMT Res. | RES, 0402 0 OHM, 5% 1/10 W | Various | |
| C7, C8 | SMT Res. | CAP, 0402 0.9 pF, 0.05% 200V, Hi-Q | Various | |

Thermal and Reliability Information

| Parameter | Values | Units | Conditions |
|---|--------|-------|--|
| TX Channel, Thermal Resistance (θ_{JC}) ^(1,3) | 7.1 | °C/W | T _{BASE} = 95°C, TXVD = 25 V, TXIDQ = 110 mA TXID_DRIVE = 482 mA, P _{IN} = 16 dBm, Freq = 9.5 GHz, P _{DISS} = 8.38 W (PA only, LNA off) |
| Channel Temperature (T _{CH}) | 154.5 | °C | |
| RX Channel, Thermal Resistance (θ_{JC}) ⁽¹⁾ | 11.0 | °C/W | T _{BASE} = 95°C, RXVD = 10 V, RXIDQ = 20 mA P _{DISS} = 0.2 W (LNA only, PA off) |
| Channel Temperature (T _{CH}) | 97.2 | °C | |

Notes:

1. Thermal resistance is referenced to package backside
2. Base or ambient temperature is 95 °C
3. Transmit Channel, RF drive is under pulse drain supply condition, PW = 100 uS, DC = 10%, P_{DISS} and ID_DRIVE are peak values.
4. Refer to the following document: [GaN Device Channel Temperature, Thermal Resistance, and Reliability Estimates](#)

Solderability and Recommended Soldering Temperature Profile

1. Compatible with the latest version of J-STD-020, Lead-free solder, peak reflow temperature 260 °C.

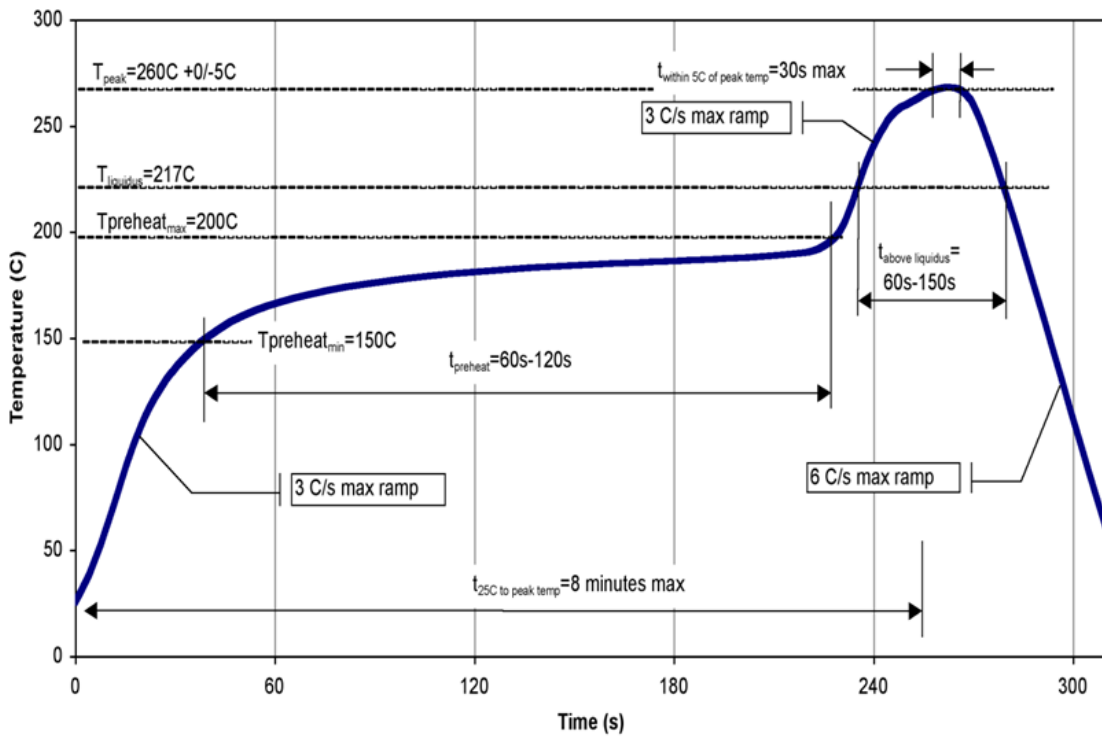

Tape and Reel Information

Standard T/R size = 750 pieces on a 7" reel.

| Material | | Cavity (mm) | | | | Distance Between Centerline (mm) | | Carrier Tape (mm) | Cover Carrier (mm) |
|----------|------------|-------------|------------|------------|------------|----------------------------------|---------------------|-------------------|--------------------|
| Vendor | Vendor P/N | Length (A0) | Width (B0) | Depth (K0) | Pitch (P1) | Length direction (P2) | Width Direction (F) | Width (W) | Width (W) |
| Advantek | ML0505-A | 5.25 | 5.25 | 1.1 | 8.0 | 2.00 | 5.50 | 12.0 | 9.20 |

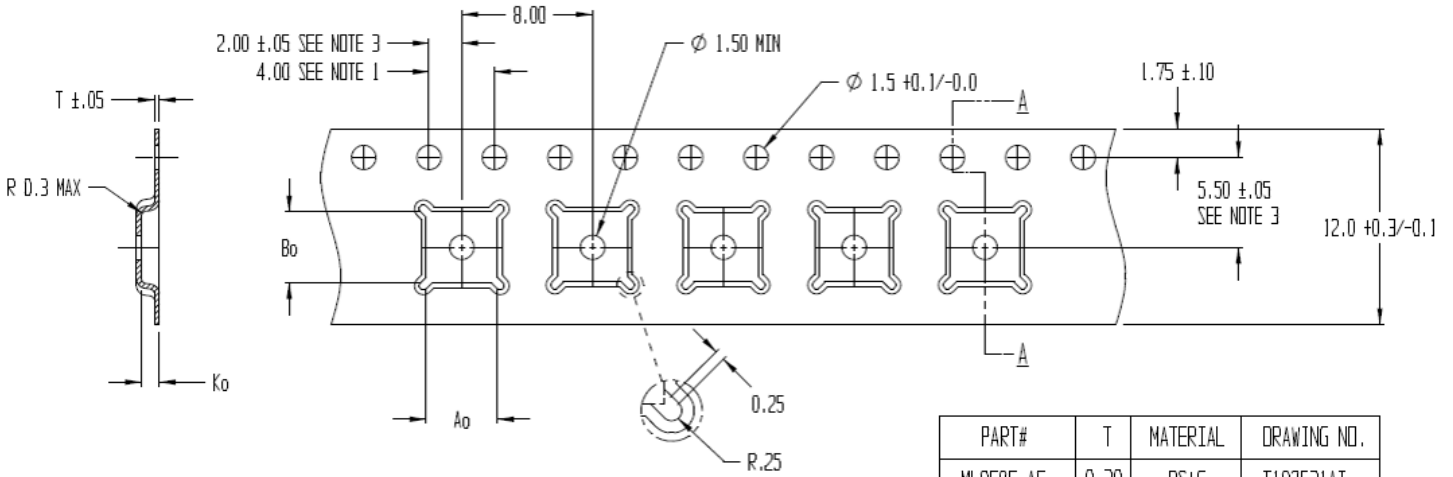

SECTION A - A

A₀ = 5.25
B₀ = 5.25
K₀ = 1.10

| PART# | T | MATERIAL | DRAWING NO. |
|-----------|------|----------|-------------|
| ML0505-AC | 0.30 | PS+C | T102531AT |
| ML0505-AD | 0.30 | PS+C | T108759BT |
| ML0505-AI | 0.25 | PS+C | T111798BT |

