

Product Overview

QPQ1028 is a L1/L2 GPS dual filter in a compact size for use in any GPS application. Designed for rejection of spurious signals, this SAW dual filter also has excellent power handling capability for low power transmitters.

Housed in a 5.0 x 5.0 mm laminate with overmold package, this device allows for a compact and cost-effective dual filter solution for GPS applications.

No matching components are required, making the PCB design and implementation easy.

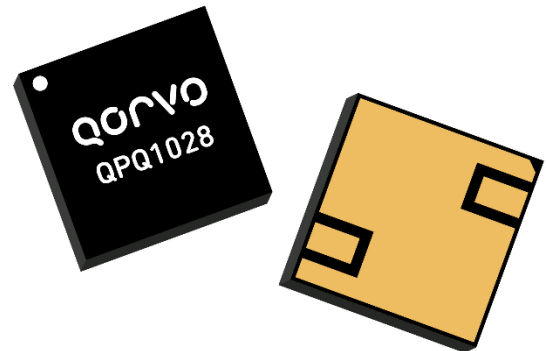

2 Pin 5 x 5 mm Leadless SMT Package

Functional Block Diagram

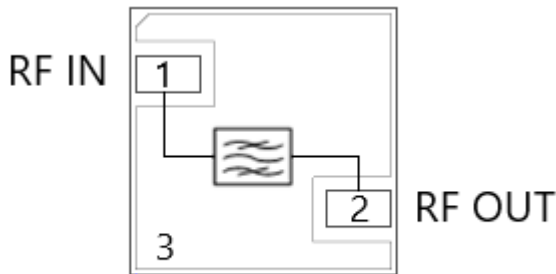

Pin Configuration

Pin No.	Label
1	RF Input ⁽¹⁾
2	RF Output ⁽¹⁾
3	Ground

⁽¹⁾ Blocking capacitors are required on any ports where a DC voltage may be present.

Key Features

- Usable Bandwidth 24 MHz
- Low Insertion Loss: <3.5 dB
- High Out of Band Attenuation
- Small Size 5x5 mm Plastic Overmold package

Performance is typical across frequency. Please reference electrical specification table and data plots for more details.

Applications

- Dual Band GPS Receivers

Ordering Information

Part No.	Description
QPQ1028SR	100 Piece 7" Short Reel
QPQ1028TR7	1000 Piece 7" Reel
QPQ1028EVB	Evaluation Board

Absolute Maximum Ratings

Parameter	Rating
Storage Temperature	-40 to 105°C
Operation Temperature	-40 to 75°C
RF Input Power - Test conditions: Passband CW, 500 msec max pulse duration, @ +25 °C	34 dBm

Exceeding any one or a combination of the Absolute Maximum Rating conditions may cause permanent damage to the device. Extended application of Absolute Maximum Rating conditions to the device may reduce device reliability.

Minimum Lifetime Ratings

Conditions	Rating
RF Input Power ⁽¹⁾ , Pin 1	>10 years

⁽¹⁾ Input Power: Passband CW, 25 dBm, @ +75 °C

Electrical Specifications ^(1,2) - Module

Test conditions unless otherwise noted: Temperature Range = -40 °C to +75 °C, 50 Ω system

Parameter ⁽³⁾	Conditions	Min	Typ. ⁽⁴⁾	Max	Units
Operational Frequency L2		1215.60	1228.69	1239.60	MHz
Operational Frequency L1		1563.42	1576.46	1587.42	MHz
Attenuation 5 MHz to 1077.6 MHz	Ref 0 dB	34.0	37.3	-	dB
Attenuation 1377.6 MHz to 1425.42 MHz	Ref 0 dB	34.0	37.7	-	dB
Attenuation 1725.42 MHz to 2500 MHz	Ref 0 dB	34.0	38.3	-	dB
Attenuation 2.5 GHz to 11 GHz	Ref 0 dB	4.0	6.5	-	dB
Attenuation 11 GHz to 40 GHz	Ref 0 dB	4.0	6.0	-	dB
Operating Temperature		-40	+25	+75	°C

Notes:

1. All specifications are based on the Qorvo schematics for the reference designs shown on page 4.
2. In production, devices will be tested at room temperature to a guard banded specification to ensure electrical compliance over temperature.
3. Electrical margin has been built into the design to account for the variations due to temperature drift and manufacture tolerances.
4. Typical values are based on average measurements at room temperature on pcb. (25 °C ±5 °C)

Electrical Specifications ^(1,2) – L2 Performance

Test conditions unless otherwise noted: Temperature Range = -40 °C to +75 °C, 50 Ω system

Parameter ⁽³⁾	Conditions	Min	Typ. ⁽⁴⁾	Max	Units
Operational Frequency L2		1215.600	1228.690	1239.600	MHz
Lower 3.0 dB Passband Edge	Ref Loss @ 1227.6 MHz	-	1204.024	1212.600	MHz
Upper 3.0 dB Passband Edge	Ref Loss @ 1227.6 MHz	1242.600	1253.130	-	MHz
Lower 3.5 dB Passband Edge	Ref 0 dB	-	1208.761	1215.600	MHz
Upper 3.5 dB Passband Edge	Ref 0 dB	1239.600	1248.620	-	MHz
Insertion Loss	Ref 0 dB, 1215.6MHz to 1239.6 MHz	-	2.6	3.5	dB
Input Return Loss	1215.6MHz to 1239.6 MHz	10.0	11.7	-	dB
Output Return Loss	1215.6MHz to 1239.6 MHz	10.0	12.3	-	dB
Amplitude Variation	1215.6 MHz to 1239.6 MHz (p-p)	-	0.74	1.25	dB
Phase Linearity	1215.6 MHz to 1239.6 MHz (p-p)	-	6.9	13.0	Deg

Electrical Specifications ^(1,2) – L1 Performance

Test conditions unless otherwise noted: Temperature Range = -40 °C to +75 °C, 50 Ω system

Parameter ⁽³⁾	Conditions	Min	Typ. ⁽⁴⁾	Max	Units
Operational Frequency L1		1563.420	1576.460	1587.420	MHz
Lower 3.0 dB Passband Edge	Ref Loss @ 1575.42 MHz	-	1550.501	1560.420	MHz
Upper 3.0 dB Passband Edge	Ref Loss @ 1575.42 MHz	1590.420	1604.890	-	MHz
Lower 3.5 dB Passband Edge	Ref 0 dB	-	1556.354	1563.420	MHz
Upper 3.5 dB Passband Edge	Ref 0 dB	1587.420	1596.557	-	MHz
Insertion Loss	Ref 0 dB, 1563.42 MHz to 1587.42 MHz	-	3.0	3.5	dB
Input Return Loss	1563.42 MHz to 1587.42 MHz	10.0	12.6	-	dB
Output Return Loss	1563.42 MHz to 1587.42 MHz	10.0	13.3	-	dB
Amplitude Variation	1563.42 MHz to 1587.42 MHz (p-p)	-	0.60	1.25	dB
Phase Linearity	1563.42 MHz to 1587.42 MHz (p-p)	-	6.8	12.0	Deg

Notes:

1. All specifications are based on the Qorvo schematics for the reference designs shown on page 4.
2. In production, devices will be tested at room temperature to a guard banded specification to ensure electrical compliance over temperature.
3. Electrical margin has been built into the design to account for the variations due to temperature drift and manufacture tolerances.
4. Typical values are based on average measurements at room temperature on pcb. (25 °C ±5 °C)

QPQ1028PCB Evaluation Board

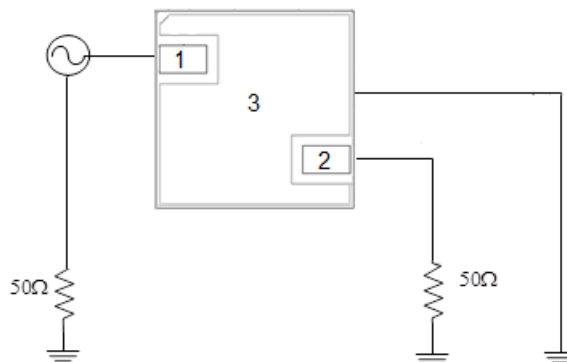
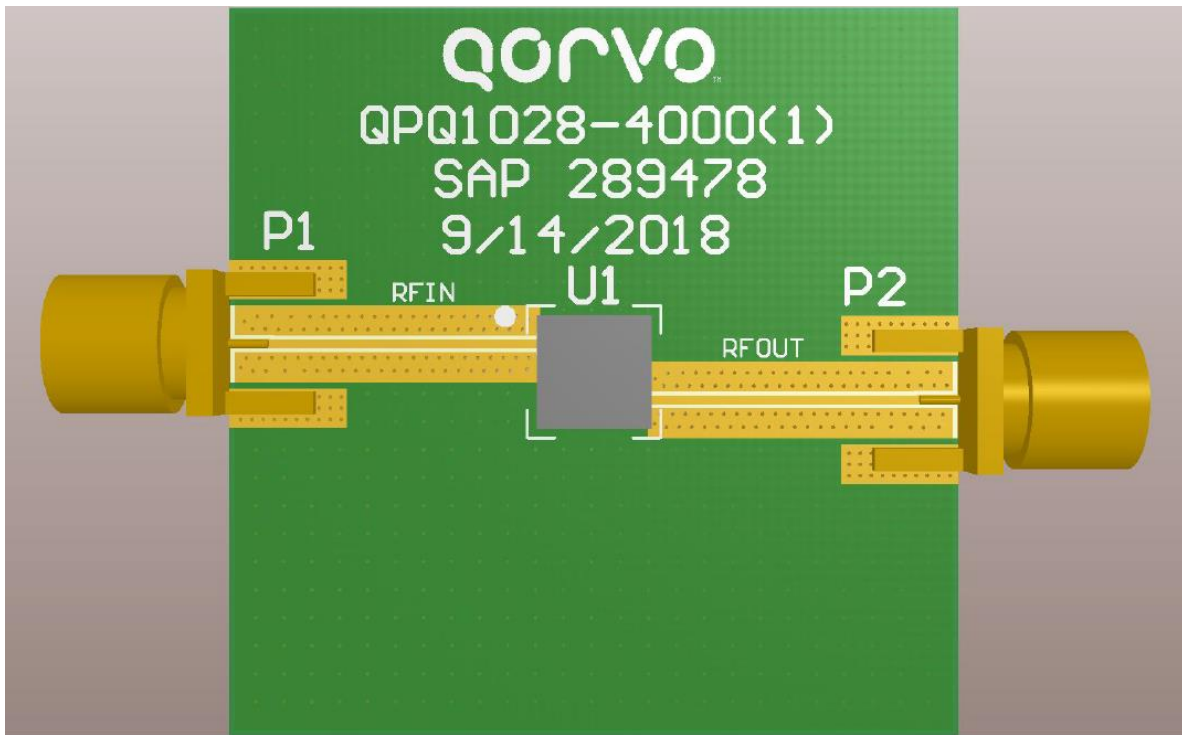

Notes: Blocking capacitors are required on any RF ports where a DC voltage may be present.

Bill of Material – QPQ1028-EVB

Reference Des.	Value	Description	Manuf.	Part Number
U1	-	Dual-Use GPS L1/L2 Dual Filter	Qorvo	QPQ1028
P1, P2, P3	-	SMA Edge connector	Various	
PCB	-	Printed Circuit Board	Various	

L1 Typical Performance Plots

Test conditions unless otherwise noted: Temps = -40 °C, +25 °C, +75 °C, 50 Ω system

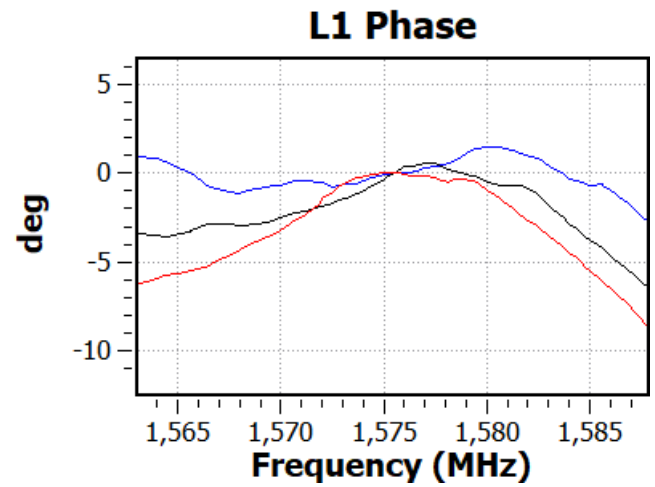
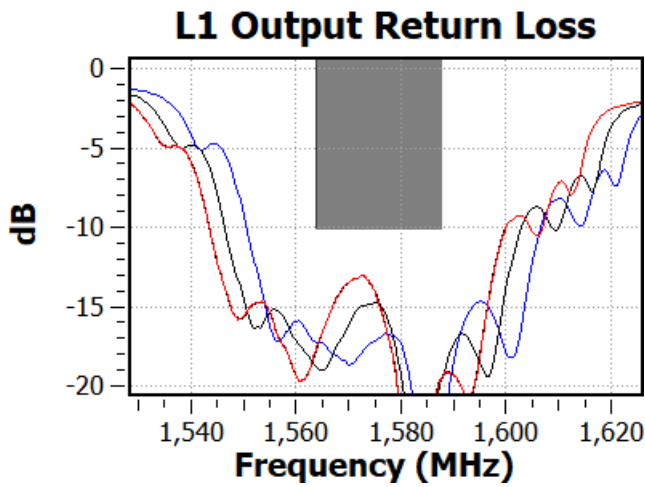
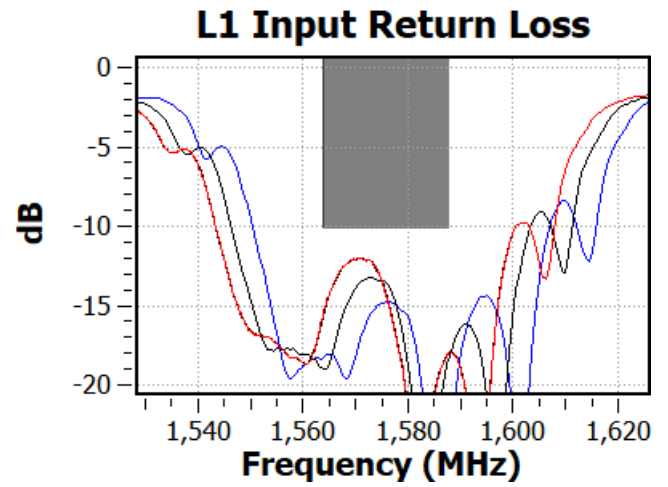
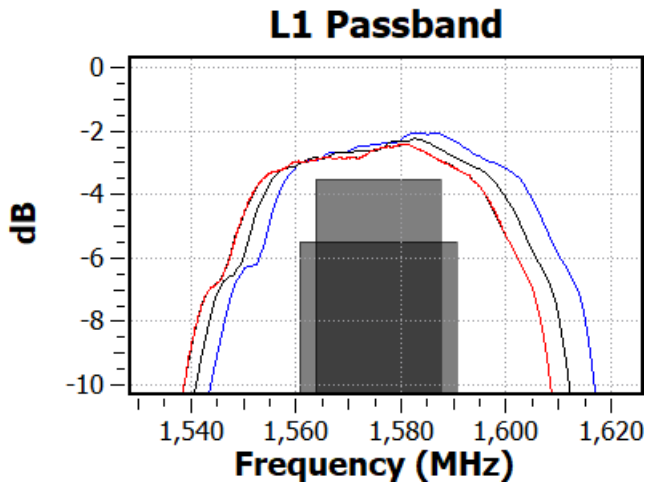

L2 Typical Performance Plots

Test conditions unless otherwise noted: Temps = -40 °C, +25 °C, +75 °C, 50 Ω system

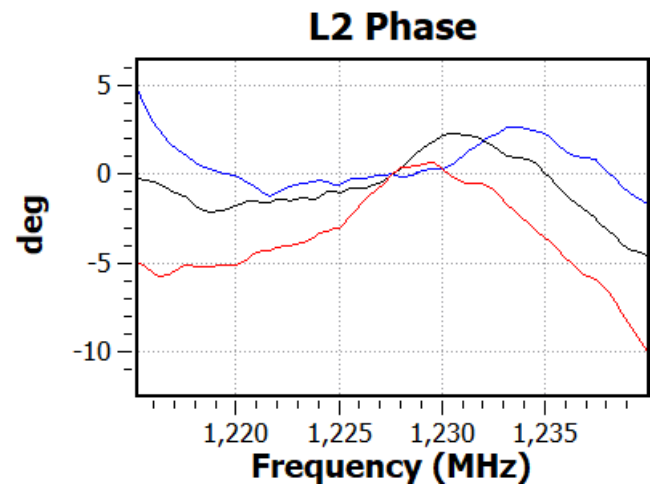
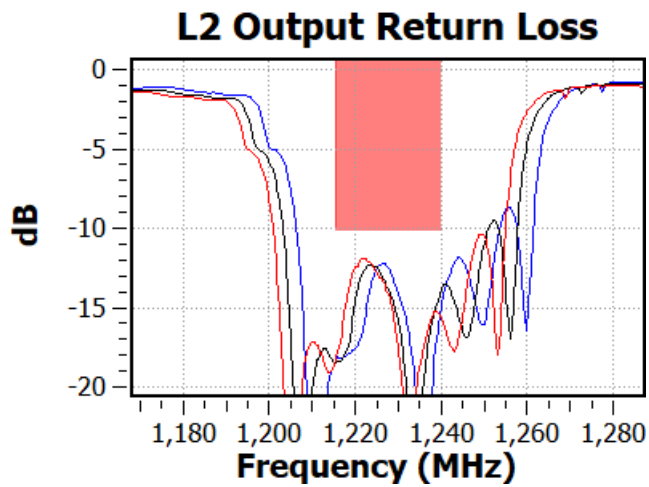
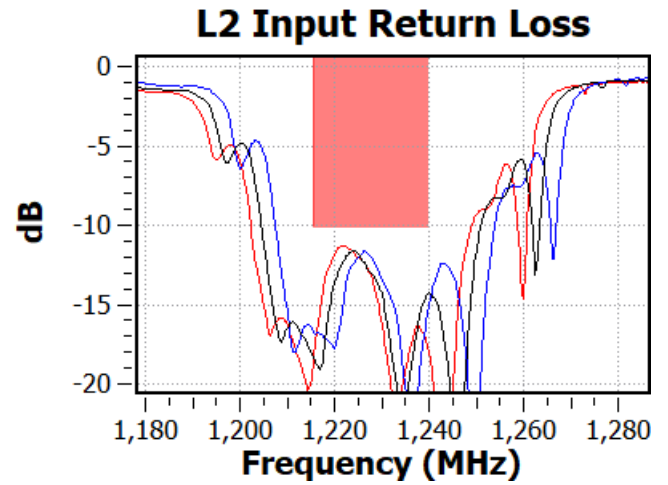
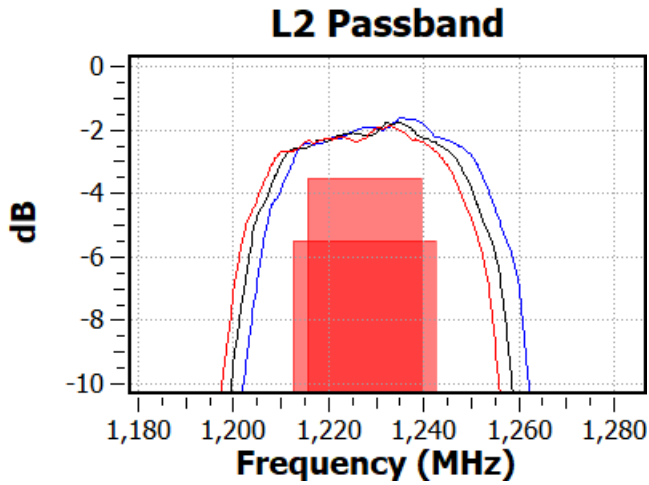

L1-L2 Typical Performance Plots

Test conditions unless otherwise noted: Temps = -40 °C, +25 °C, +75 °C, 50 Ω system

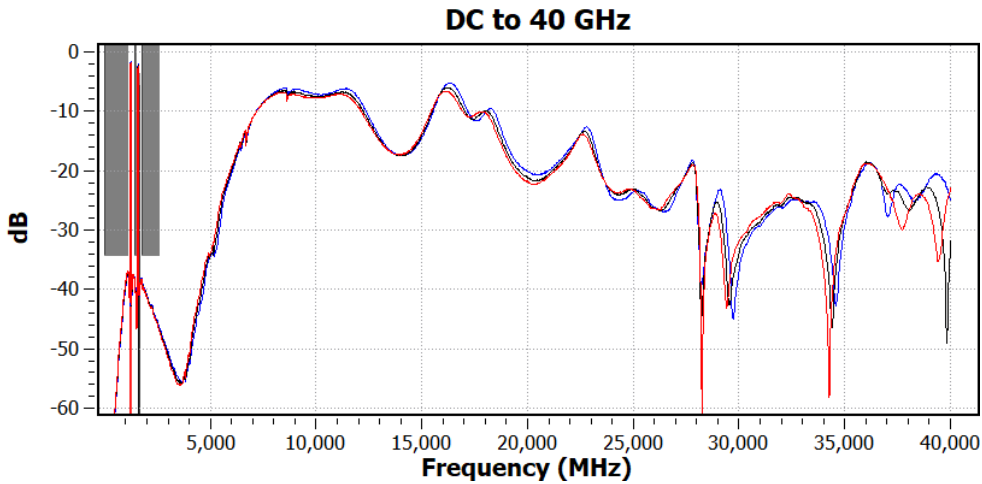
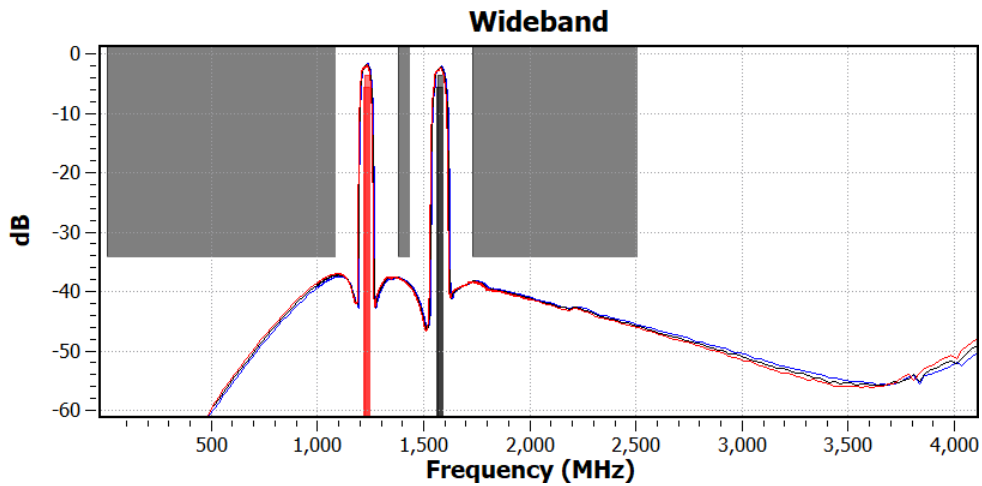
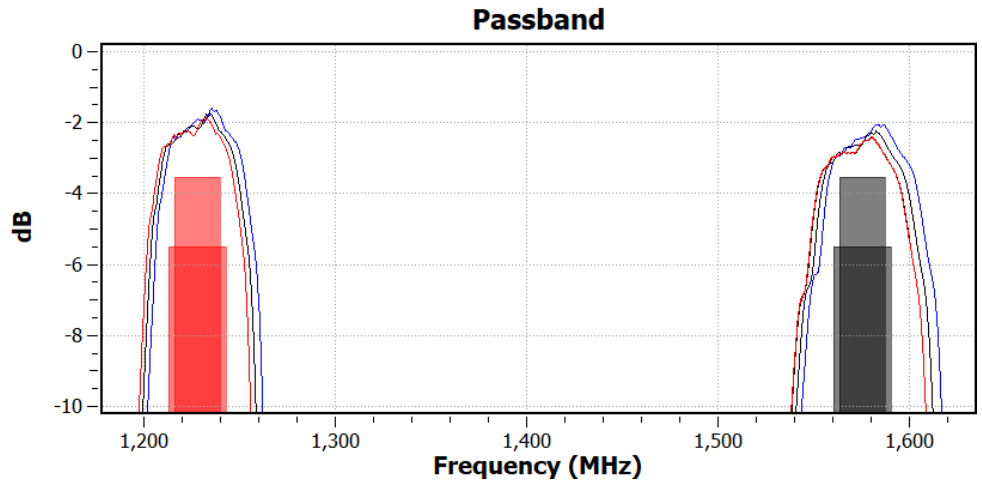

Package Marking and Dimensions

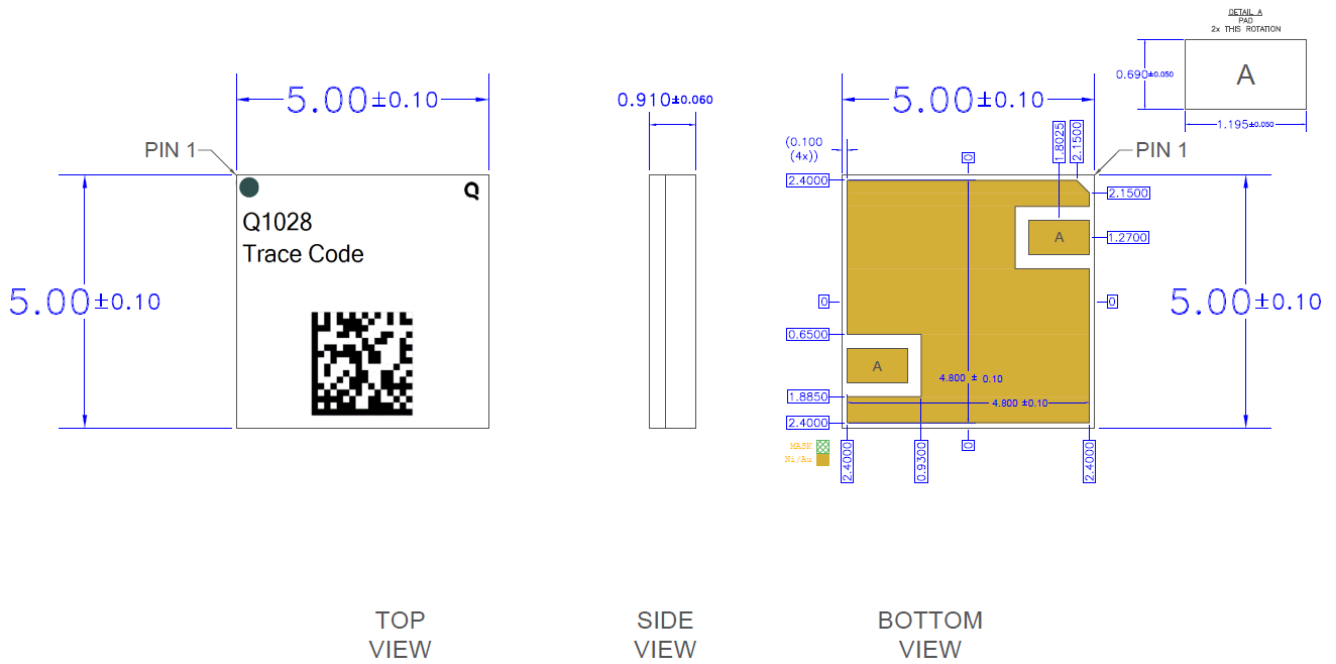

NOTES: UNLESS OTHERWISE SPECIFIED:

1. PACKAGE LEADS ARE GOLD PLATING
2. PART IS PLASTIC OVERMOLD
3. PART MARKING:
 QORVO Logo
 PART NUMBER: 1028
 TRACE CODE: Assigned by subcontractor
4. ALL DIMENSIONS ARE IN MILLIMETERS. ANGLEA ARE IN DEGREES
5. DIMENSIONS AND TOLERANCE FORMATS CONFORM TO SPE-000677.

PCB Mounting Pattern

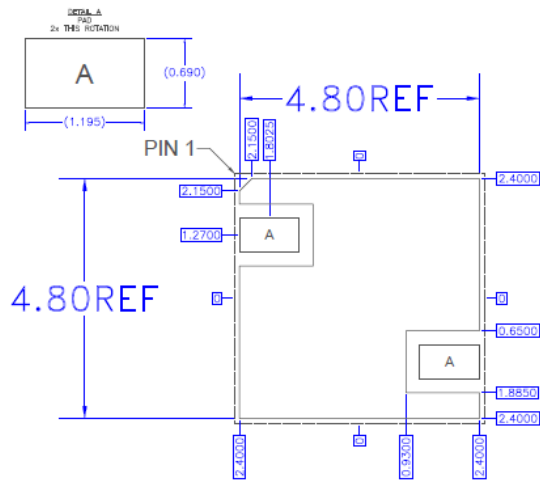

RECOMMENDED
LAND PATTERN

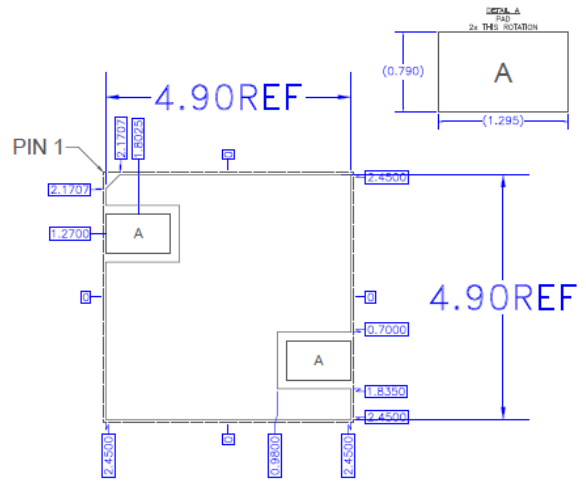

RECOMMENDED
LAND PATTERN MASK

Notes:

1. All dimensions are in millimeters.
2. This drawing specifies the mounting pattern used on the Qorvo evaluation board for this product. Some modification may be necessary to suit end user assembly materials and processes.

Assembly Notes

Compatible with both lead-free (260°C peak reflow temp.) and tin/lead (245°C peak reflow temp.) soldering processes.

Contact Plating: ENEPIG.

Recommended Soldering Temperature Profile

