

WORLD-BEAM® QS186LE Laser Emitter



Datasheet



Class 1 and 2 lasers for use with Banner modulated photoelectric receivers.

- Self-contained Class 1 or Class 2 modulated visible laser diode emitters permit higher gain than LEDs and extended range in opposed-mode sensing systems
- Narrow effective beam provides small-object detection and precise position control
- Bright spot and multiple shapes provide great visual marking of objects
- 10 V dc to 30 V dc operation
- Laser beam enabled by white wire (pin 2)



WARNING: Not To Be Used for Personnel Protection

Never use this device as a sensing device for personnel protection. Doing so could lead to serious injury or death. This device does not include the self-checking redundant circuitry necessary to allow its use in personnel safety applications. A sensor failure or malfunction can cause either an energized or de-energized sensor output condition.

Models ¹	Laser Class	Laser Spot Shape	Excess Gain at 15 m (50 ft) ²	Typical Beam Size
QS186LE	Class 1	Small Spot	With receiver Q23SN6R: 7500	See Table 1 on page 3.
			With receiver SM31RL: 340	
			With receiver QS18VN6R: 4500	
			With receiver VS3AN5R: 2100	
			With receiver VS2AN5R: 1100	
QS186LE10	Class 1	Circle	-	See Table 1 on page 3.
QS186LE11		Vertical Line	-	
QS186LE12		Horizontal Line	-	
QS186LE14		Cross	-	
QS186LE2	Class 2	Small Spot	With receiver Q23SN6R: 12200	See Table 2 on page 4.
			With receiver SM31RL: 1200	
			With receiver QS18VN6R: 7000	
			With receiver VS3AN5R: 5500	
			With receiver VS2AN5R: 3600	
QS186LE210	Class 2	Circle	-	See Table 2 on page 4.
QS186LE211		Vertical Line	-	
QS186LE212		Horizontal Line	-	
QS186LE214		Cross	-	

¹ Integral 2 m (6.5 ft) unterminated cable models are listed.

- To order the 9 m (30 ft) PVC cable model, add the suffix "W/30" to the cabled model number. For example, "QS18LE W/30".
- To order the 150 mm (6 in) PVC cable model with a 4-pin M8/Pico-style quick disconnect, add the suffix "Q" to the model number. For example, "QS18LEQ".
- To order the 4-pin M8/Pico-style integral quick disconnect model, add the suffix "Q7" to the model number. For example, "QS18LEQ7".
- To order the 150 mm (6 in) PVC cable model with a 4-pin M12/Euro-style quick disconnect, add the suffix "Q5" to the model number. For example, "QS18LEQ5".
- To order the 4-pin M12/Euro-style integral quick disconnect model, add the suffix "Q8" to the model number. For example, "QS18LEQ8".
- Models with a quick disconnect require a mating cordset.

² Not recommended for dusty or dirty environments; the scattered light would greatly reduce excess gain.



Description of Laser Classes

Class 1 Lasers. Lasers that are safe under reasonably foreseeable conditions of operation, including the use of optical instruments for intrabeam viewing.

Reference IEC 60825-1:2001, section 8.2.

Class 1 Laser Characteristics: see specifications.

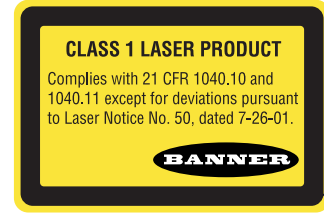

Class 2 Lasers. Low-power lasers are by definition incapable of causing eye injury within the duration of the blink (aversion response) of 0.25 seconds. This reaction may be expected to provide adequate protection under reasonably foreseeable conditions of operation, including the use of optical instruments for intrabeam viewing. They also must emit only visible wavelengths (400–700 nm). Therefore, an ocular hazard can exist only if an individual overcomes their natural aversion to bright light and stares directly into the laser beam.

For safe laser use:

- Do not permit a person to stare at the laser from within the beam.
- Do not point the laser at a person's eye at close range.
- The beam emitted by a Class 2 laser product should be terminated at the end of its useful path. Open laser beam paths should be located above or below eye level where practical.

Reference IEC 60825-1:2001, section 8.2.

Class 2 Laser Characteristics: see specifications.



CAUTION: Do Not Disassemble for Repair

This device contains no user-serviceable components. Do not attempt to disassemble for repair. Use of controls or adjustments or performance of procedures other than those specified herein may result in hazardous radiation exposure. A defective unit must be returned to the manufacturer.

Installation

To mount the QS186LE into bracket models SMB18A or SMB46A, follow these steps.

1. Insert the laser emitter into the hole in the bracket.
2. Tighten the hex jam nut to the bracket until the emitter is held securely in place.
3. Mount the bracket using user-supplied screws or bolts. The SMB18A bracket uses M4 or #8 screws or bolts and the SMB46A bracket uses M5 or #10 screws or bolts.
4. Check the sensor alignment, see [Alignment](#) on page 3. If you are using the adjustable bracket (model SMB46A), tighten or loosen one or two of the precision alignment screws, using the supplied 2 mm Allen wrench, until the laser is accurately aligned.

Wiring Diagram

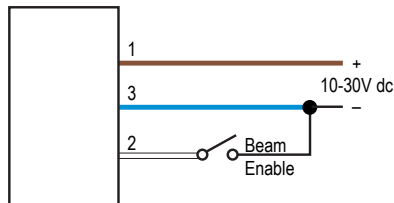

Key

- 1 = Brown
- 2 = White
- 3 = Blue
- 4 = Black (Not used)

Pinout

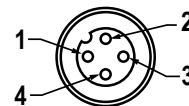

Quick disconnect wiring diagrams are functionally identical.

Alignment

Conventional modulated infrared LED photoelectric emitters are designed with beam divergence angles of several degrees. As a result, most emitters are easily aligned to their receivers by simple line-of-sight methods.

The beam widths listed (see [Figure 1](#) on page 3) are also the effective beam sizes at the receiver for model QS186LE. The effective beam size is equal to the minimum opaque object profile required to block the laser beam. The beam size at the emitter is 2.5 mm (0.1 inches) diameter. Beam sizes at various distances for other models are shown in the tables below.

The effect of angular misalignment is dramatic (see [Figure 3](#) on page 4). The wide beam angles offered by conventional photoelectric emitters allow several degrees of misalignment between the optical axes of the emitter and receiver. This is not true for laser emitters, which require the beam center to directly strike the receiver lens. The figures show how far the laser beam will miss the center of the receiver lens for one degree of angular misalignment (in any plane). Note that even at a 5 foot range, one degree of misalignment will cause the laser beam to miss the lens of most receivers.

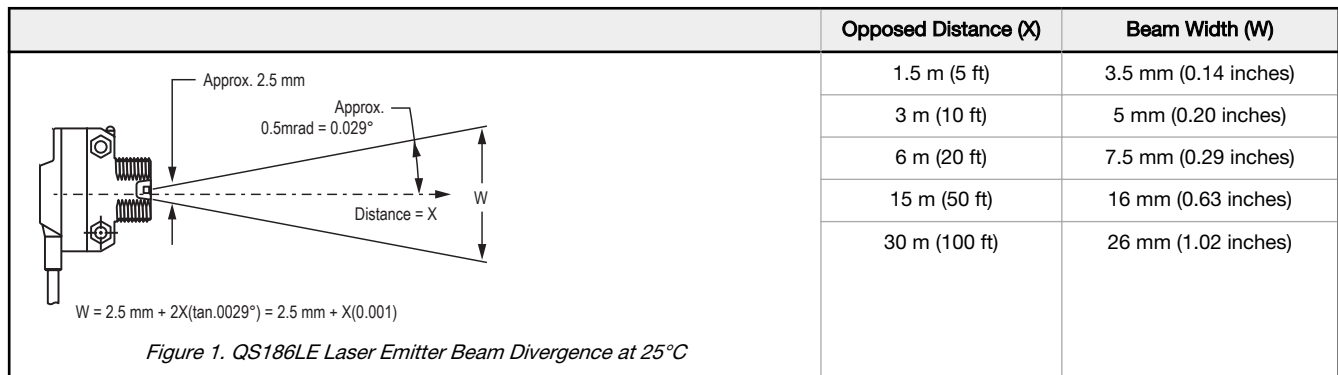

Table 1: Typical Beam Size vs Distance (Class 1 Lasers)

Typical Beam Size vs. Distance, Class 1 Lasers							
Small Spot (Model QS186LE)							
Distance	1.5 m (5 ft)	3 m (10 ft)	6 m (20 ft)	15 m (50 ft)	30 m (100 ft)	-	-
Spot Size	3.5 mm (0.14 in)	5 mm (0.2 in)	7.5 mm (0.29 in)	16 mm (0.63 in)	26 mm (1.02 in)	-	-
Circle (Model QS186LE10) ³							
Distance	0.4 m (1.3 ft)	0.8 m (2.6 ft)	1 m (3.3 ft)	2 m (6.6 ft)	3 m (10 ft)	4 m (13 ft)	5 m (16 ft)
Circle Diameter	16 mm (0.63 in)	32 mm (1.26 in)	40 mm (1.57 in)	82 mm (3.23 in)	120 mm (4.72 in)	158 mm (6.22 in)	196 mm (7.72 in)
Vertical Line (Model QS186LE11) ⁴							
Distance	0.2 m (0.6 ft)	0.4 m (1.3 ft)	0.6 m (1.9 ft)	0.8 m (2.6 ft)	1 m (3.3 ft)	1.5 m (5 ft)	2 m (6.6 ft)
Line Size	80 x 3 mm (3.1 x 0.1 in)	145 x 3 mm (5.7 x 0.1 in)	210 x 3 mm (8.3 x 0.1 in)	270 x 3 mm (10.6 x 0.1 in)	330 x 3 mm (13.0 x 0.1 in)	480 x 3 mm (18.9 x 0.1 in)	600 x 3 mm (23.6 x 0.1 in)
Horizontal Line (Model QS186LE12) ⁴							
Distance	0.2 m (0.6 ft)	0.4 m (1.3 ft)	0.6 m (1.9 ft)	0.8 m (2.6 ft)	1 m (3.3 ft)	1.5 m (5 ft)	2 m (6.6 ft)
Line Size	95 x 2 mm (3.7 x 0.1 in)	175 x 2 mm (6.9 x 0.1 in)	252 x 2 mm (9.9 in x 0.1 in)	333 x 2.5 mm (13.1 x 0.1 in)	418 x 2.5 mm (16.5 x 0.1 in)	613 x 3 mm (24.1 x 0.1 in)	765 x 3 mm (30.1 x 0.1 in)
Cross (Model QS186LE14) ³							
Distance	0.4 m (1.3 ft)	0.8 m (2.6 ft)	1 m (3.3 ft)	2 m (6.6 ft)	3 m (10 ft)	4 m (13 ft)	5 m (16 ft)
Line Size	60 mm (2.4 in)	125 mm (4.9 in)	155 mm (6.1 in)	310 mm (12.2 in)	460 mm (18.1 in)	615 mm (24.2 in)	760 mm (29.9 in)

³ May contain a small collimated spot in the center of the pattern. For best focus, view circle at distances greater than 1 meter and cross at distances greater than 0.3 m (image is not crisp at closer distances).

⁴ Light distribution is non-uniform, having less light at ends. The horizontal line is more uniform than the vertical line.

Alignment Tip: The visible red beam of the laser emitter is easily seen in subdued lighting. At opposed distances of up to 10 feet, attach a sheet of white paper directly in front of the receiver lens and mark the location of the lens center on the paper. Using the mark as an aiming target, sight along the beam from directly behind the laser emitter. Adjust the emitter mounting until the dot of red light is centered exactly on the mark. Remove the paper and check the response of the receiver.

For longer distances (up to 25 feet), replace the white paper with a 4 x 4 inch square of high-grade retroreflective tape (Banner model BRT-THG-4X4-5 or equivalent; see [Figure 2](#) on page 4). For greater distances, use a larger sheet of retroreflective material (see [Retroreflective Tape](#) on page 6).

At long distances, use retroreflective tape to locate the beam at the desired location. Never use a mirror as an alignment target.

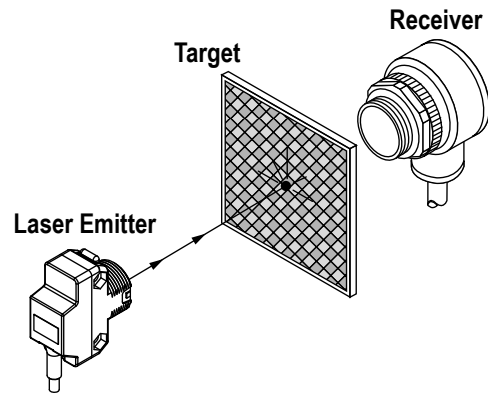

Figure 2. Long Distance Alignment

	Opposed Distance (X)	Beam Displacement (Y) for 1° of Misalignment
<p>Figure 3. Beam Displacement per Degree of Misalignment</p>	1.5 m (5')	25 mm (0.98")
	3 m (10')	50 mm (1.96")
	6 m (20')	100 mm (3.92")
	15 m (50')	250 mm (9.84")
	30 m (100')	500 mm (19.7")

Table 2: Typical Beam Size vs Distance (Class 2 Lasers)

Typical Beam Size vs. Distance, Class 2 Lasers							
Small Spot (Model QS186LE2)							
Distance	1.5 m (5 ft)	3 m (10 ft)	6 m (20 ft)	15 m (50 ft)	30 m (100 ft)	-	-
Spot Size	3.8 mm (0.15 in)	5.1 mm (0.2 in)	10.2 mm (0.4 in)	17.8 mm (0.7 in)	30.5 mm (1.2 in)	-	-
Circle (Model QS186LE210) ⁵							
Distance	0.4 m (1.3 ft)	0.8 m (2.6 ft)	1 m (3.3 ft)	2 m (6.6 ft)	3 m (10 ft)	4 m (13 ft)	5 m (16 ft)
Circle Diameter	17.8 mm (0.7 in)	33 mm (1.3 in)	41.9 mm (1.65 in)	82.3 mm (3.25 in)	122 mm (4.8 in)	160 mm (6.3 in)	198 mm (7.8 in)
Vertical Line (Model QS186LE211) ⁶							
Distance	0.2 m (0.6 ft)	0.4 m (1.3 ft)	0.6 m (1.9 ft)	0.8 m (2.6 ft)	1 m (3.3 ft)	1.5 m (5 ft)	2 m (6.6 ft)
Line Size	72.1 x 2.5 mm (2.8 x 0.1 in)	150 x 2.5 mm (5.9 x 0.1 in)	208 x 2.5 mm (8.2 x 0.1 in)	284 x 2.5 mm (11.2 x 0.1 in)	350 x 2.5 mm (13.8 x 0.1 in)	502 x 2.5 mm (19.8 x 0.1 in)	660 x 2.5 mm (26 x 0.1 in)
Horizontal Line (Model QS186LE212) ⁶							
Distance	0.2 m (0.6 ft)	0.4 m (1.3 ft)	0.6 m (1.9 ft)	0.8 m (2.6 ft)	1 m (3.3 ft)	1.5 m (5 ft)	2 m (6.6 ft)
Line Size	74 x 2.5 mm (2.9 x 0.1 in)	159 x 2.5 mm (6.25 x 0.1 in)	224 x 2.5 mm (8.8 in x 0.1 in)	330 x 2.5 mm (13 x 0.1 in)	406 x 2.5 mm (16 x 0.1 in)	610 x 2.5 mm (24 x 0.1 in)	800 x 2.5 mm (31.5 x 0.1 in)
Cross (Model QS186LE214) ⁵							
Distance	0.4 m (1.3 ft)	0.8 m (2.6 ft)	1 m (3.3 ft)	2 m (6.6 ft)	3 m (10 ft)	4 m (13 ft)	5 m (16 ft)
Line Size	61 mm (2.4 in)	125 mm (4.9 in)	155 mm (6.1 in)	312 mm (12.3 in)	467 mm (18.4 in)	620 mm (24.4 in)	760 mm (29.9 in)

⁵ May contain a small collimated spot in the center of the pattern. For best focus, view circle at distances greater than 1 meter and cross at distances greater than 0.3 m (image is not crisp at closer distances).

⁶ Light distribution is non-uniform, having less light at ends. The horizontal line is more uniform than the vertical line.

Specifications

Supply Voltage and Current

10 V dc to 30 V dc (10% maximum ripple) at less than 35 mA

Supply Protection Circuitry

Protected against reverse polarity

Sensing Beam (Class 1 Laser)

Visible red Class 1 laser, 650 nm visible red (temperature coefficient 0.2 nm/°C)
 Pulse Width: 5 microseconds
 Rep Rate: 27 microseconds
 Pulse Output Power: less than 1.9 milliwatts

Sensing Beam (Class 2 Laser)

Visible red Class 2 laser, 650 nm (temperature coefficient 0.25 nm/°C)
 Pulse Width: 5 microseconds
 Rep Rate: 27 microseconds
 Pulse Output Power: less than 4 milliwatts

Environmental Rating

IEC IP67, NEMA 6, UL Type 1

Operating Conditions

-10 °C to +50 °C (+14 °F to +122 °F)
 95% at +50 °C maximum relative humidity (non-condensing)

Delay at Power Up

Class 1 Models: 250 ms
 Class 2 Models: 10 ms

Laser Control

Apply 0 V dc to white wire to enable beam
 Apply +10 to 30 V dc to white wire to inhibit beam
 Class 1 Enable Time: 240 ms; 100 ms disable time
 Class 2 Enable Time: 8 ms; 1 ms disable time

Indicators

Green LED, indicates power applied

Construction

ABS housing, PMMA window
 3 mm mounting hardware included

Connections

2 m (6.5 ft) unterminated PVC-jacketed cable, or Integral 4-pin M12/Euro-style quick disconnect

Laser Classification

Class 1 / Class 2 laser product; complies with 21 CFR 1040.10, EN 60825-1:2001 except for deviations pursuant to Laser Notice 50, dated 7-26-01

Certifications



Dimensions

Cabled Models

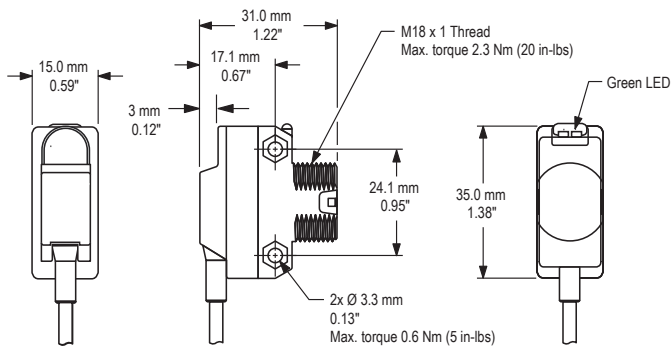

Quick Disconnect Models

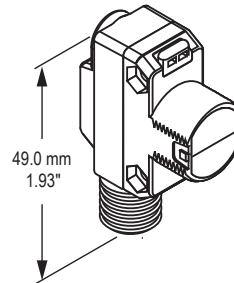

Lock Nut

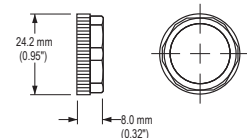

Accessories

Cordsets

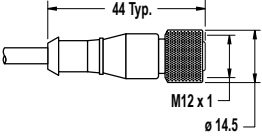
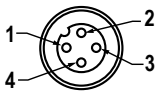
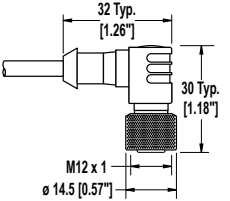
4-Pin Threaded M12/Euro-Style Cordsets				
Model	Length	Style	Dimensions	Pinout (Female)
MQDC-406	1.83 m (6 ft)	Straight		 1 = Brown 2 = White 3 = Blue 4 = Black
MQDC-415	4.57 m (15 ft)			
MQDC-430	9.14 m (30 ft)			
MQDC-450	15.2 m (50 ft)			
MQDC-406RA	1.83 m (6 ft)	Right-Angle		
MQDC-415RA	4.57 m (15 ft)			
MQDC-430RA	9.14 m (30 ft)			
MQDC-450RA	15.2 m (50 ft)			

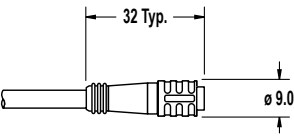
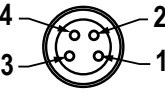
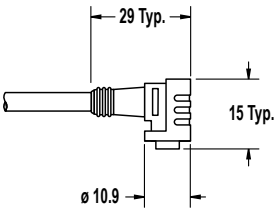
4-Pin Snap-on M8/Pico-Style Cordsets				
Model	Length	Style	Dimensions	Pinout (Female)
PKG4-2	2 m (6.56 ft)	Straight		 1 = Brown 2 = White 3 = Blue 4 = Black
PKW4Z-2	2 m (6.56 ft)	Right-Angle		

All measurements are listed in millimeters, unless noted otherwise.

Retroreflective Tape

Used for laser alignment.

Model	Reflectivity Factor	Maximum Temperature	Size
BRT-THG-4X4-5	0.7	+60 °C (+140 °F)	100 × 100 mm (package of 5)

Model	Reflectivity Factor	Maximum Temperature	Size
BRT-THG-8.5X11-2	0.7	+60 °C (+140 °F)	216 × 280 mm (package of 2)

Model	Reflectivity Factor	Maximum Temperature	Size
BRT-THG-18X36	0.7	+60 °C (+140 °F)	457 × 914 mm (single sheet)