

# WORLD-BEAM® QS18 Mechanically Adjustable Background Suppression Sensors

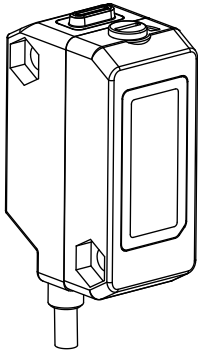

## Datasheet

Miniature sensors with visible red LED or visible red laser



- Exceptional optical performance, comparable to larger sensors
- Simple multi-turn screw adjustment of cutoff distance
- 10 V dc to 30 V dc operation, with complementary (SPDT) NPN or PNP outputs, depending on model
- Less than 1 millisecond output response for excellent sensing repeatability

### Laser Models:

- Narrow effective beam (approx. 1 mm spot size) for small-object detection and precise position control
- Crosstalk rejection algorithm to avoid optical disturbance from adjacent sensors
- Class 2 models have reduced excess gain within 20 mm of sensor for decreased susceptibility to the effects of lens contamination and to allow use of external lens shield



### WARNING: Not To Be Used for Personnel Protection

Never use this device as a sensing device for personnel protection. Doing so could lead to serious injury or death. This device does not include the self-checking redundant circuitry necessary to allow its use in personnel safety applications. A sensor failure or malfunction can cause either an energized or de-energized sensor output condition.

## Models

Models	Sensing Beam	Range	Cordset <sup>1</sup>	Supply Voltage	Output Type
QS18VN6AF100	660 nm Visible Red LED	1 mm (0.04 in) to cutoff point; Adjustable cutoff point, 20-100 mm (0.8 in-4 in)	2 m (6.5 ft) 4-wire	10 to 30 V dc	NPN
QS18VP6AF100					PNP
QS18VN6LAF	650 nm Visible Red Class 1 Laser	1 mm (0.04 in) to cutoff point; Adjustable cutoff point, 30-150 mm (1.2 in-6 in)			NPN
QS18VP6LAF					PNP
QS18VN6LAF250	658 nm Visible Red Class 2 Laser	20 mm (0.08 in) to cutoff point; Adjustable cutoff point, 50-250 mm (2 in-10 in)			NPN
QS18VP6LAF250					PNP

<sup>1</sup> Only standard 2 m (6.5 ft) cable models are listed.

- **For 9 m (30 ft) cables:** add suffix "W/30" to the model number (for example, QS18VN6AF100 W/30).
- **For 4-pin Pico-style pigtail QD:** add suffix "Q" to the model number (for example, QS18VN6AF100Q); accessory mating cordset required.
- **For 4-pin Euro-style pigtail QD:** add suffix "Q5" to the model number (for example, QS18VN6AF100Q5); accessory mating cordset required.



## Overview

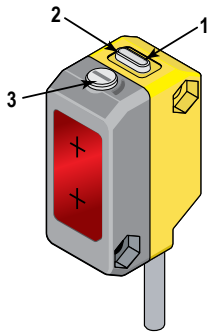

Figure 1. Sensor features

The QS18 Adjustable-Field Sensors are a full-featured sensor in a miniature package. It provides background suppression sensing capability for small or difficult-to-reach areas. Models are available with a visible red LED sensing beam, or one of two visible red lasers (see [Models](#) on page 1).

These adjustable-field sensors are able to detect objects of relatively low reflectivity, while ignoring other objects in the background (beyond the cutoff point). The cutoff distance is mechanically adjustable, using the 5-turn adjustment screw on the sensor top. Backgrounds and background objects must *always* be placed beyond the cutoff distance.

1. Green: Power Indicator (Flashes for Output Overload)
2. Amber: Light Sensed Indicator (Flashes for Low Gain Conditions)
3. Cutoff Point Adjustment Screw

## Adjustable-Field Sensing — Theory of Operation

The sensor compares the reflections of its emitted light beam (E) from an object back to the sensor's two differently-aimed detectors R1 and R2 (see [Figure 2](#) on page 2). If the near detector (R1) light signal is stronger than the far detector (R2) light signal (see object A, closer than the cutoff distance), the sensor responds to the object. If the far detector (R2) light signal is stronger than the near detector (R1) light signal (see object B, object beyond the cutoff distance), the sensor ignores the object.

The cutoff distance for these sensors is adjustable. Objects lying beyond the cutoff distance are ignored, even if they are highly reflective. However, it is possible to falsely detect a background object, under certain conditions (see [Background Reflectivity and Placement](#) on page 4).

In this document, the letters E, R1, and R2 identify how the sensor's three optical elements (Emitter "E", Near Detector "R1", and Far Detector "R2") line up across the face of the sensor. The location of these elements defines the sensing axis (see [Figure 6](#) on page 4). The sensing axis becomes important in certain situations, such as those illustrated in [Figure 10](#) on page 5 and [Figure 11](#) on page 5.

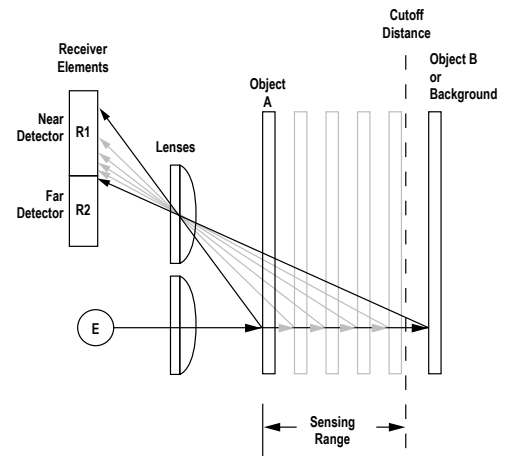

Figure 2. Adjustable field sensing concept

## Color Sensitivity

The effects of object reflectivity on cutoff distance, though small, may be important for some applications. It is expected that at any given cutoff setting, the actual cutoff distance for lower reflectance targets will be slightly shorter than for higher reflectance targets (see the cutoff point deviation graphs). This behavior is known as color sensitivity.

The excess gain curves were generated using a white test card of 90% reflectance. Objects with reflectivity of less than 90% reflect less light back to the sensor, and thus require proportionately more excess gain in order to be sensed with the same reliability as more reflective objects. When sensing an object of very low reflectivity, it may be especially important to sense it at or near the distance of maximum excess gain.

In the cutoff point deviation graphs, the percentage of deviation indicates a change in the cutoff point for either 18% gray or 6% black targets, relative to the cutoff point set for a 90% reflectance white test card.

For example, in [Figure 3](#) on page 3, the cutoff point decreases 10% for a 6% reflectance black target when the cutoff point is adjusted for 100 mm (4 in) using a 90% reflectance white test card. In other words, the cutoff point for the black target is 90 mm (3.6 in) for this setting.

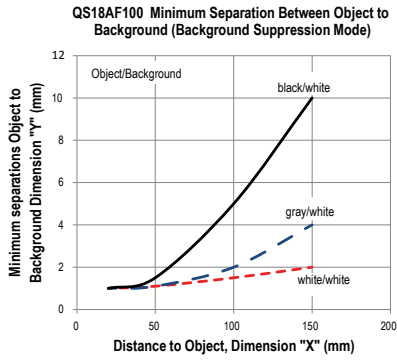

Figure 3. QS18AF100 minimum separation between object and background

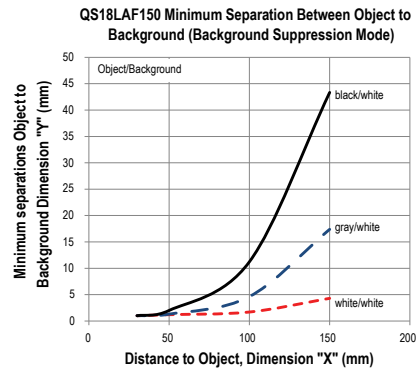

Figure 4. QS18LAF150 minimum separation between object and background

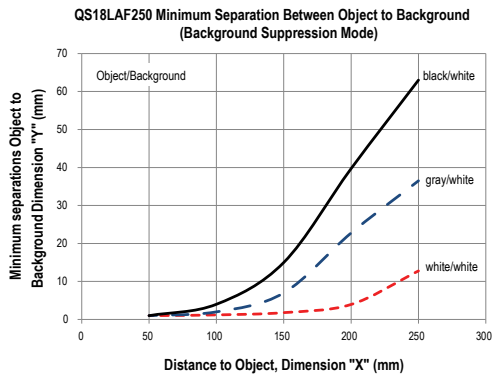
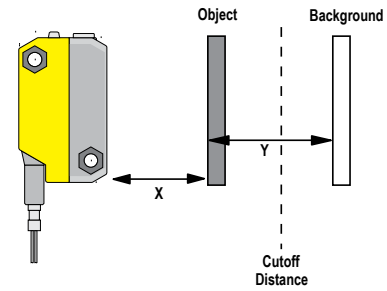

Figure 5. QS18LAF250 minimum separation between object and background



X: Distance to Object (mm)

Y: Minimum Separation Between Object and Background (mm)

## Installation

### Wiring Diagrams

Cabled wiring diagrams are shown. Quick disconnect (QD) wiring diagrams are functionally identical.

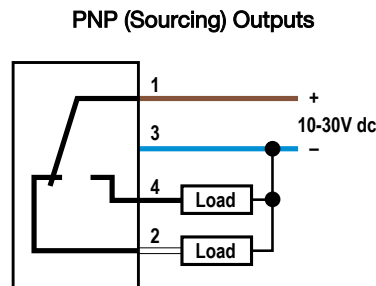
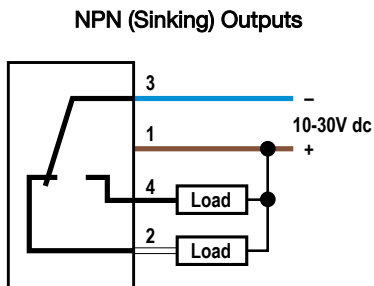

#### Wiring Key

- 1 = Brown
- 2 = White
- 3 = Blue
- 4 = Black

## Setting the Cutoff Distance

The cutoff distance for the QS18AF models may be adjusted between 20 mm and 100 mm (0.8 in to 4 in); for QS18LAF models, between 30 mm and 150 mm (1.2 in to 6 in); and for QS18LAF250 models, between 50 mm and 250 mm (2 in to 10 in).

To properly set the cutoff point, position the lightest possible background to be used, at the closest position it will come to the sensor during use. Using a small screwdriver in the adjustment screw, adjust the cutoff distance until the threshold is reached and the yellow Light Sensed indicator changes state. (If the indicator never comes ON, the background is beyond the maximum sensing distance and will be ignored.) Repeat the procedure, using the darkest target, placed in its most distant position for sensing. Adjust the cutoff approximately midway between the two positions (*Figure 7* on page 4).

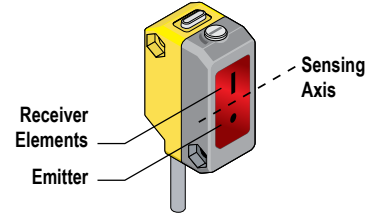

When an object approaches from the side, the most reliable sensing usually occurs when the line of approach is parallel to the sensing axis.

Figure 6. Sensing Axis

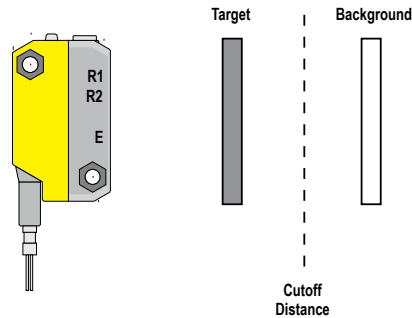

Figure 7. Set cutoff distance approximately midway between the farthest target and the closest background

## Sensing Reliability

For highest sensitivity, position the target for sensing at or near the point of maximum excess gain. See the Performance Curves section for the excess gain curves. Maximum excess gain for model QS18VN6AF100 at a 20 mm cutoff occurs at a lens-to-object distance of about 7 mm, for example. Sensing at or near this distance makes the maximum use of each sensor's available sensing power. The background must be placed beyond the cutoff distance. Note that the reflectivity of the background surface also may affect the cutoff distance. Following these guidelines improves sensing reliability.

## Background Reflectivity and Placement

Avoid mirror-like backgrounds that produce specular reflections. A false sensor response occurs if a background surface reflects the sensor's light more to the near detector (R1) than to the far detector (R2). The result is a false ON condition (*Figure 8* on page 5). Correct this problem by using a diffusely reflective (matte) background, or angling either the sensor or the background (in any plane) so the background does not reflect light back to the sensor (*Figure 9* on page 5). Position the background as far beyond the cutoff distance as possible.

An object beyond the cutoff distance, either stationary (and when positioned as shown in *Figure 10* on page 5), or moving past the face of the sensor in a direction perpendicular to the sensing axis, may cause unwanted triggering of the sensor if more light is reflected to the near detector than to the far detector. Correct the problem by rotating the sensor 90° (*Figure 11* on page 5). The object then reflects the R1 and R2 fields equally, resulting in no false triggering. A better solution, if possible, may be to reposition the object or the sensor.

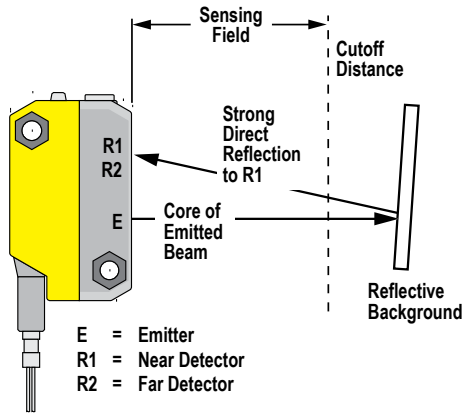

Figure 8. Reflective Background - Problem

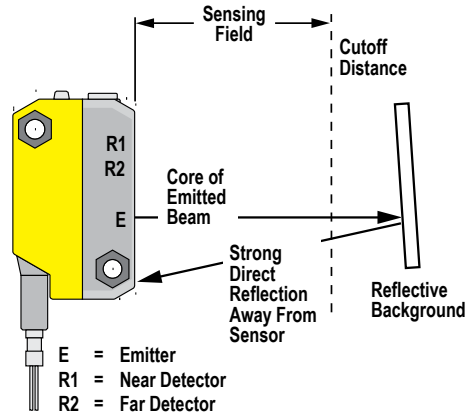
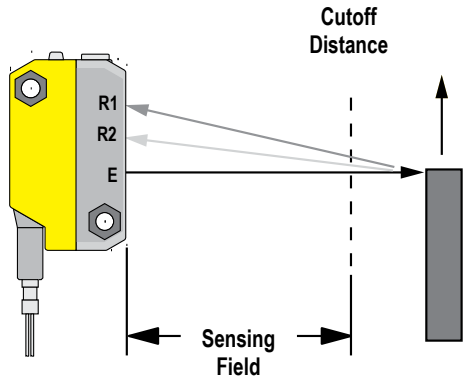
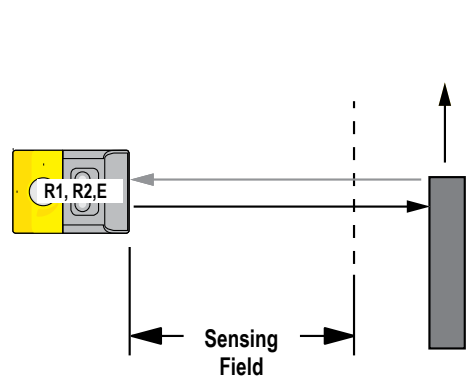

Figure 9. Reflective Background - Solution



A reflective background object in this position or moving across the sensor face in this axis and direction may cause a false sensor response.

Figure 10. Object Beyond Cutoff - Problem



A reflective background object in this position or moving across the sensor face in this axis is ignored.

Figure 11. Object Beyond Cutoff - Solution

## Specifications

### Supply Voltage

**QS18AF Models:** 10 to 30 V dc (10% maximum ripple) at less than 25 mA, exclusive of load;

**QS18LAF / QS18LAF250 Models:** 10 to 30 V dc (10% maximum ripple) at less than 15 mA, exclusive of load

### Sensing Beam

**QS18AF Models:** Visible red LED, 640 nm

**QS18LAF / QS18LAF250 Models:** Visible red laser (see below)

### Laser Characteristics - QS18AF Models

N/A

### Laser Characteristics - QS18LAF Models

Wavelength: 650 nm visible red Class 1 laser

Pulse Width: 7 microseconds

Rep Rate: 130 microseconds

Average Output Power: 0.065 mW

### Laser Characteristics - QS18LAF250 Models

Wavelength: 658 nm visible red Class 2 laser

Pulse Width: 7 microseconds

Rep Rate: 130 microseconds

Average Output Power: 0.2 mW

### Supply Protection Circuitry

Protected against reverse polarity and transient voltages

### Output Configuration - All Models

**Solid-state complementary (SPDT):** NPN or PNP (current sinking or sourcing), depending on model;

**Rating:** 100 mA maximum each output at 25 °C

Protected against false pulse on power-up and continuous overload or short circuit of outputs

### Output Configuration - QS18AF Models

**Off-state leakage current:** less than 50 µA at 30 V dc

**ON-state saturation voltage:** less than 1.5 V at 10 mA; less than 3.0 V at 100 mA

### Output Configuration - QS18LAF / QS18LAF250 Models

**Off-state leakage current:** NPN: less than 200 µA at 30 V dc (See Application Note 1); PNP: less than 10 µA at 30 V dc

**ON-state saturation voltage:** NPN: less than 1.6 V at 100 mA; PNP: less than 3.0 V at 100 mA

### Output Response

**QS18AF Models:** 850 microseconds ON/OFF; 100 ms delay on power-up; outputs do not conduct during this time

**QS18LAF / QS18LAF250 Models:** 700 microseconds ON/OFF; 200 ms delay on power-up; outputs do not conduct during this time

### Connections

2 m (6.5 ft) 4-wire PVC cable, 9 m (30 ft) PVC cable, 4-pin Pico-style or Euro-style 150 mm (6 in) pigtail QD, depending on model

### Environmental Rating

IEC IP67; NEMA 6; UL Type 1

### Operating Conditions

95% relative humidity at 50 °C (non-condensing)

**QS18AF Models:** -20 °C to +70 °C (-4 °F to +158 °F)

**QS18LAF / QS18LAF250 Models:** -10 °C to 50 °C (14 °F to 122 °F)

### Certifications



### Application Notes

NPN off-state leakage current is < 200 µA for load resistances > 3 kΩ or optically isolated loads. For load current of 100 mA, leakage is < 1% of load current.

### Repeatability

**QS18AF Models:** 85 microseconds

**QS18LAF / QS18LAF250 Models:** 130 microseconds

### Spot Size

QS18AF100	
Distance (mm)	Size (Horizontal x Vertical)
20	5 x 5
75	7 x 7
150	10 x 10

QS18LAF150	
Distance (mm)	Size (Horizontal x Vertical)
30	3.0 x 1.0
75	3.0 x 1.0
150	2.5 x .80

QS18LAF250	
Distance (mm)	Size (Horizontal x Vertical)
50	2.2 x 1.1
125	2.0 x 1.0
250	1.5 x .75

### Adjustments

Five-turn adjustment screw sets cutoff distance between min. and max. positions, clutched at both ends of travel

### Construction

ABS housing, acrylic lens cover, 2.5 mm and 3 mm mounting hardware included

### Laser Classification

**QS18AF Models:** N/A

**QS18LAF Models:** Class 1 laser product; Complies with IEC 60825-1:2001 and 21 CFR 1040.10, except for deviations pursuant to Laser Notice 50, dated 7-26-01

**QS18LAF250 Models:** Class 2 laser product; Complies with IEC 60825-1:2001 and 21 CFR 1040.10, except for deviations pursuant to Laser Notice 50, dated 7-26-01

### Required Overcurrent Protection



**WARNING:** Electrical connections must be made by qualified personnel in accordance with local and national electrical codes and regulations.

Overcurrent protection is required to be provided by end product application per the supplied table. Overcurrent protection may be provided with external fusing or via Current Limiting, Class 2 Power Supply. Supply wiring leads < 24 AWG shall not be spliced. For additional product support, go to [www.bannerengineering.com](http://www.bannerengineering.com).

Supply Wiring (AWG)	Required Overcurrent Protection (Amps)
20	5.0
22	3.0
24	2.0
26	1.0
28	0.8
30	0.5

## Dimensions

All measurements are listed in millimeters [inches], unless noted otherwise.

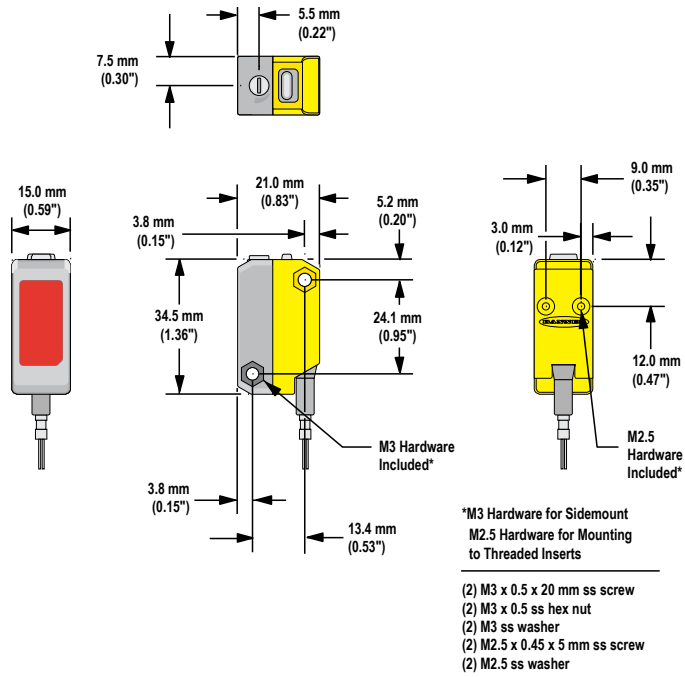

Figure 12. QS18AF Dimensions

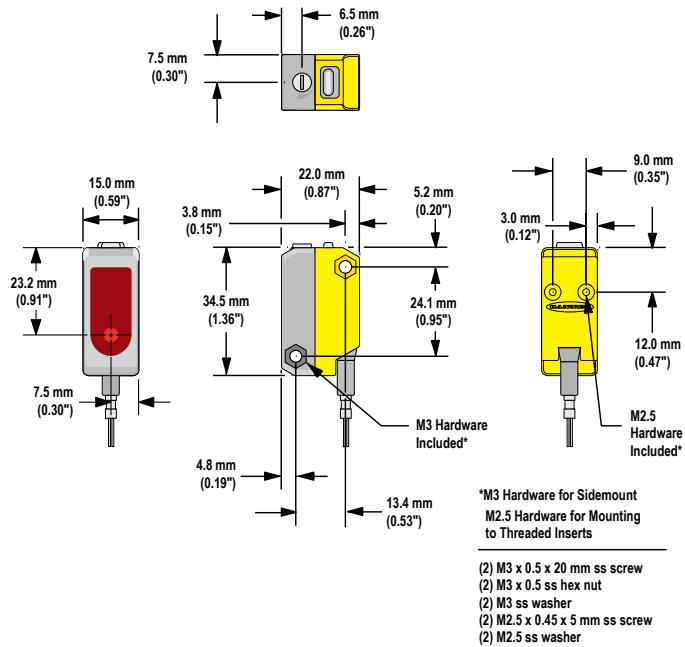
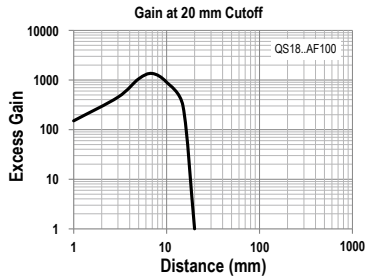

Figure 13. QS18LAF and QS18LAF250

## Performance Curves—Excess Gain

Performance based on 90% reflectance white test card

**Gain at 20 mm Cutoff**



**Gain at 100 mm Cutoff**

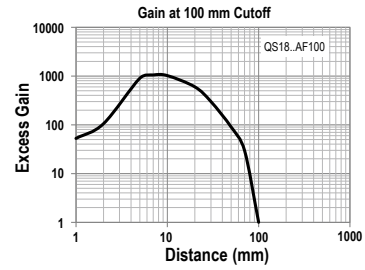

**Gain at 30 mm Cutoff**

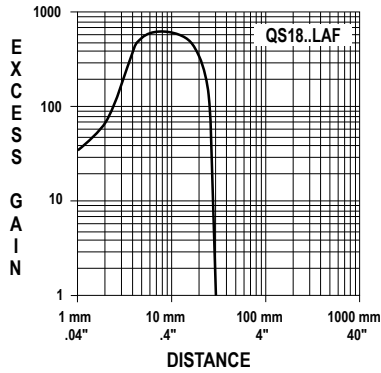

**Gain at 150 mm Cutoff**

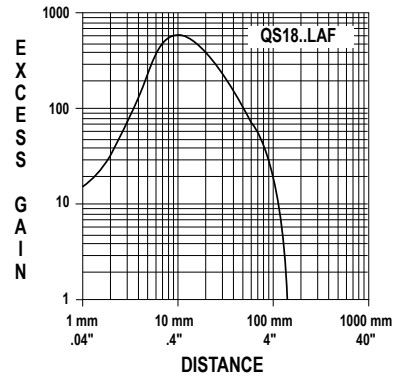

**Gain at 50 mm Cutoff**

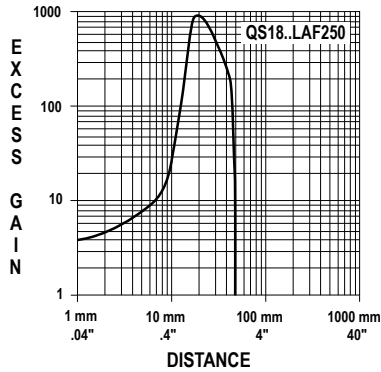

**Gain at 250 mm Cutoff**

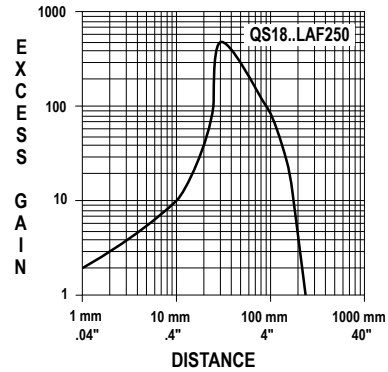

## Description of Laser Classes

### Class 1 Lasers

Class 1 lasers are lasers that are safe under reasonably foreseeable conditions of operation, including the use of optical instruments for intrabeam viewing.

Reference IEC 60825-1:2001, Section 8.2.

**Class 1 Laser Characteristics:** See [Specifications](#) on page 6.





**CAUTION: Do Not Disassemble for Repair**

This device contains no user-serviceable components. Do not attempt to disassemble for repair. Use of controls or adjustments or performance of procedures other than those specified herein may result in hazardous radiation exposure. A defective unit must be returned to the manufacturer.



### Class 2 Lasers

Class 2 lasers are lasers that emit visible radiation in the wavelength range from 400 nm to 700 nm, where eye protection is normally afforded by aversion responses, including the blink reflex. This reaction may be expected to provide adequate protection under reasonably foreseeable conditions of operation, including the use of optical instruments for intrabeam viewing.

Reference IEC 60825-1:2001, Section 8.2.

**Class 2 Laser Characteristics:** See [Specifications](#) on page 6.

### For Safe Laser Use (Class 1 or Class 2):

- Do not stare at the laser.
- Do not point the laser at a person's eye.
- Mount open laser beam paths either above or below eye level, where practical.
- Terminate the beam emitted by the laser product at the end of its useful path.

## Accessories

### Quick-Disconnect (QD) Cordsets

Use the Pico-style cordsets with QS18 with Q suffix; use the Euro-style cordsets with QS18 with Q% suffix.

4-Pin Snap-on M8/Pico-Style Cordsets				
Model	Length	Style	Dimensions	Pinout (Female)
PKG4-2	2 m (6.56 ft)	Straight		<p>1 = Brown 2 = White 3 = Blue 4 = Black</p>

4-Pin Threaded M12/Euro-Style Cordsets				
Model	Length	Style	Dimensions	Pinout (Female)
MQDC-406	1.83 m (6 ft)	Straight		<p>1 = Brown 2 = White 3 = Blue 4 = Black</p>
MQDC-415	4.57 m (15 ft)			
MQDC-430	9.14 m (30 ft)			
MQDC-450	15.2 m (50 ft)			