

Arria 10 SoC Development Kit User Guide



Subscribe



Send Feedback

UG-20004
2016.03.01

101 Innovation Drive
San Jose, CA 95134
www.altera.com

ALTERA
now part of Intel®

Contents

Arria 10 SoC Development Kit Overview.....	1-1
General Description.....	1-1
Board Component Blocks.....	1-3
Recommended Operating Conditions.....	1-5
Handling the Board.....	1-5
Getting Started.....	2-1
Board Inspection	2-1
Installing the Subscription Edition of the Quartus Prime Design Software.....	2-1
Activating Your License.....	2-3
Installing the Altera SoC Embedded Development Suite (EDS).....	2-3
Development Kit Installer.....	2-4
Installing the USB-Blaster Driver.....	2-5
SD Card Image with Example Software.....	2-5
Development Board Setup.....	3-1
Applying Power to the Board.....	3-1
Default Switch and Jumper Settings.....	3-2
Board Test System.....	4-1
Preparing the Board.....	4-2
Running the Board Test System.....	4-3
Using the Board Test System.....	4-4
Using the Configure Menu.....	4-4
The System Info Tab.....	4-5
The GPIO Tab.....	4-7
The XCVR Tab.....	4-9
The PCIe Tab.....	4-13
The FMCA Tab.....	4-16
The FMCB Tab.....	4-20
The DDR3 Tab.....	4-24
The DDR4 Tab.....	4-26
The Power Monitor.....	4-28
The Clock Control.....	4-30
Board Components.....	5-1
Board Overview.....	5-1
Featured Device: Arria 10 SoC	5-5
MAX V CPLD 5M2210 System Controller.....	5-6

FPGA Configuration.....	5-15
System Controller Configuration.....	5-16
FPGA Programming over On-Board USB-Blaster II.....	5-16
FPGA Programming by HPS.....	5-18
FPGA Programming by EPCQ Device.....	5-18
FPGA Programming over External USB-Blaster.....	5-18
Status Elements.....	5-19
Setup Elements.....	5-19
Board Settings DIP Switch.....	5-19
JTAG Chain Control DIP Switch.....	5-20
Reference Clock Source Selection.....	5-22
CPU Reset Push Button.....	5-22
Logic Reset Push Button.....	5-22
General User Input/Output.....	5-22
Character LCD.....	5-22
Clock Circuitry.....	5-23
On-Board Oscillators.....	5-23
Components and Interfaces.....	5-24
PCI Express.....	5-24
10/100/1000 Ethernet (HPS).....	5-26
10/100/1000 Ethernet (FPGA).....	5-28
FMC.....	5-29
HPS Shared I/O.....	5-44
USB 2.0 Port (HPS).....	5-46
RS-232 UART (HPS).....	5-46
Real-Time Clock (HPS).....	5-47
SFP+.....	5-47
I ² C Interface.....	5-48
FPGA-I/O MAX V Interface.....	5-49
HPS SPIO Interface.....	5-51
Memory.....	5-64
FPGA External Memory.....	5-65
HPS External Memory.....	5-72
HPS Boot Flash Interface.....	5-76
I ² C EEPROM.....	5-76
Daughtercards.....	5-77
Board Power Supply.....	5-78
Power Distribution System.....	5-79
Power Measurement.....	5-79
Additional Information.....	A-1
Board & User Guide Revision History.....	A-1
Compliance and Conformity Statements.....	A-2
CE EMI Conformity Caution.....	A-2

Arria 10 SoC Development Kit Overview

1

2016.03.01

UG-20004



Subscribe



Send Feedback

This document describes the hardware features of the Arria[®] 10 SoC development board, including the detailed pin-out and component reference information required to create custom FPGA designs that interface with all components of the board.

General Description

The Arria 10 SoC development board provides a hardware platform for developing and prototyping low-power, high-performance, and logic-intensive designs using Altera's[®] Arria 10 SoC. The board provides a wide range of peripherals and memory interfaces to facilitate the development of Arria 10 SoC designs.

Figure 1-1: Arria 10 SoC Block Diagram

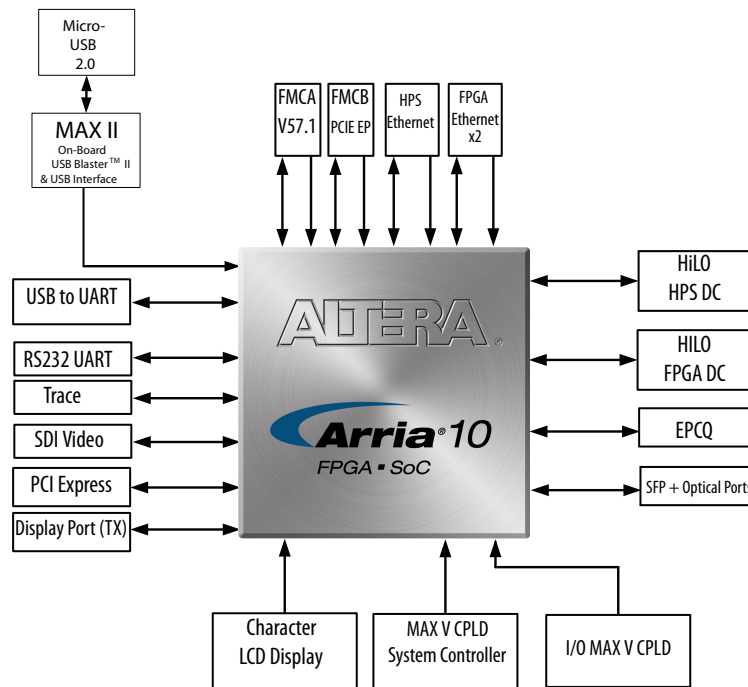

© 2016 Altera Corporation. All rights reserved. ALTERA, ARRIA, CYCLONE, ENPIRION, MAX, MEGACORE, NIOS, QUARTUS and STRATIX words and logos are trademarks of Altera Corporation and registered in the U.S. Patent and Trademark Office and in other countries. All other words and logos identified as trademarks or service marks are the property of their respective holders as described at www.altera.com/common/legal.html. Altera warrants performance of its semiconductor products to current specifications in accordance with Altera's standard warranty, but reserves the right to make changes to any products and services at any time without notice. Altera assumes no responsibility or liability arising out of the application or use of any information, product, or service described herein except as expressly agreed to in writing by Altera. Altera customers are advised to obtain the latest version of device specifications before relying on any published information and before placing orders for products or services.

ISO
9001:2008
Registered

ALTERA
now part of Intel

Figure 1-2: Overview of the Development Board Features

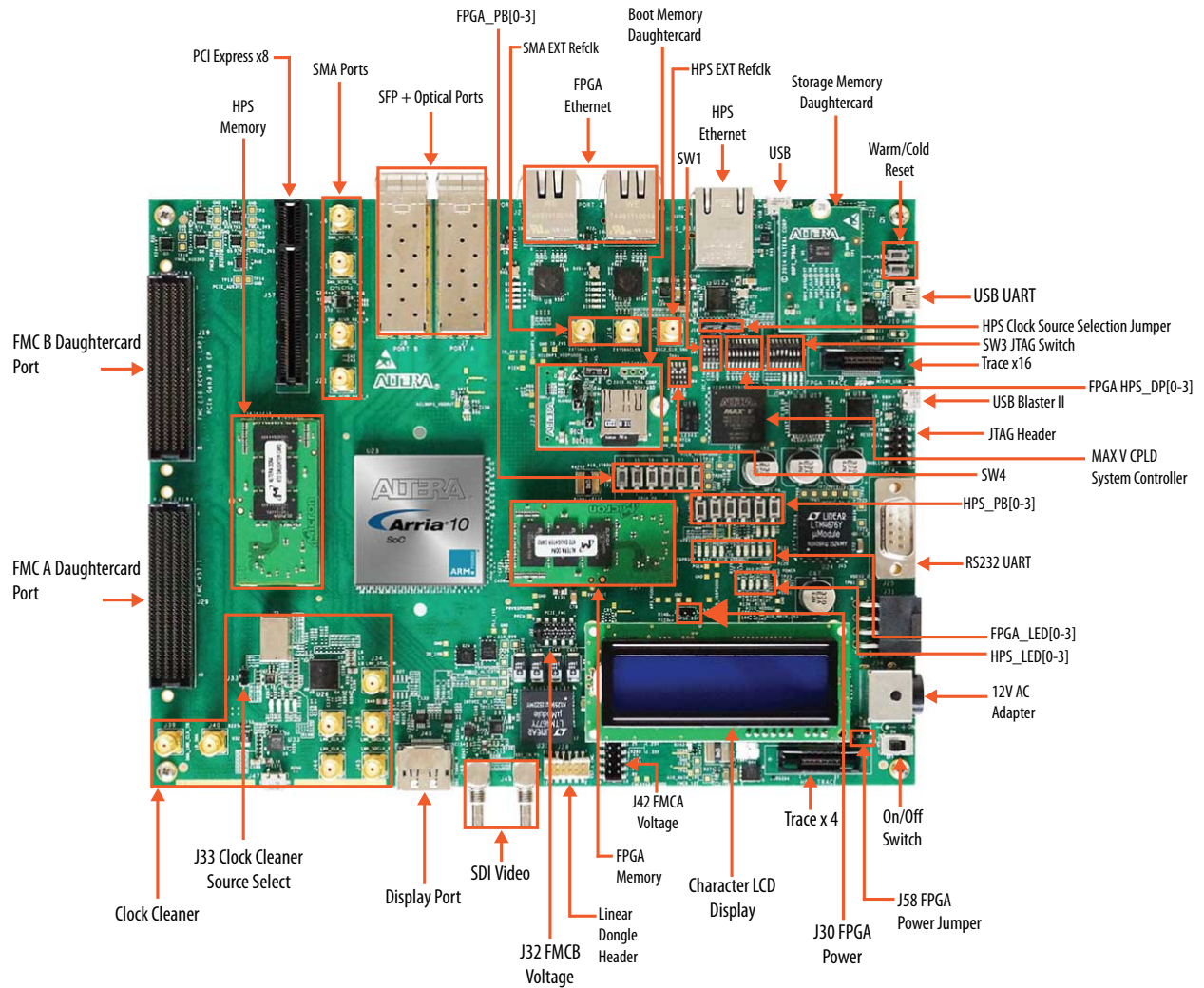

For more information about the Arria 10 SoC device family, refer to the [Arria 10 SoC documentation support page](#).

Related Information

[Arria 10 Documentation](#)

Board Component Blocks

The development board features the following major component blocks:

- Arria 10 Soc (10AS066N3F40E2SGE2) in a 1517-pin FBGA (FineLine Ball-Grid Array) package
- FPGA configuration circuitry
 - Active Serial (AS) x1 or x4 configuration (EPCQ1024L)
 - MAX[®] V CPLD (5M2210ZF256) in a 256-pin FBGA package as the system controller
 - MAX V CPLD (5M2210ZF256) in a 256-pin FBGA package as the I/O multiplier CPLD
- Clocking circuitry
 - SI5338 programmable oscillator
 - LMK04828 clock cleaner
 - HPS clock options: 25 MHz, 33 MHz, and SMA input (2V5 LVCMOS)
 - SI5112 100MHz clock generator for PCIe interface
 - SI516 148.5 MHz voltage control oscillator for SDI interface
- Supported Memory
 - HPS memory size (HiLO card):
 - 2GB DDR3 (256Mb x 40 x dual rank)
 - 1GB DDR3 (256Mb x 40 x single rank)
 - 1GB DDR4 (256Mb x 40 x single rank) - *ships with kit*
 - FPGA memory size (HILO Card):
 - 4GB DDR3 (256Mb x72 x dual rank)
 - 2GB DDR3 (256Mb x72 x single rank)
 - 2GB DDR4 (256Mb x 72 x single rank) - *ships with kit*
 - 16MB QDRV (4Mb x 36)
 - 128MB RLD RAM3(16Mb x 72)
 - HPS Boot Flash (Flash card):
 - NAND flash (x8) : 128MB (MT29F1G08ABBEAH4) - *ships with kit*
 - QSPI flash: 128MB (MT25QU01GBBA8E12-0SIT) - *ships with kit*
 - SD Micro flash card: 4GB (Kingston) - *ships with kit*
 - Optional FPGA File Flash (Flash card):
 - NAND flash (x8): 128MB (MT29F1G08ABBEAH4)
 - QSPI flash: 128MB (MT25QU01GBBA8E12-0SIT)
 - SD Micro flash card: 4GB (Kingston)

- Communication ports
 - HPS Communication ports:
 - USB 2.0 port (PHY PN: USB3320C-EZK)
 - RGMII 10/100/1000 Ethernet port (PHY PN: KSZ9031RNXCA)
 - USB-UART port (FT232R)
 - DB-9 RS-232 Port (MAX3221)
 - I²C port (I2C1 of shared I/O bit 12 and 13)
 - FPGA I/O connections:
 - FPGA V57.1 High Pin Count FMC slot
 - FPGA Altera Low Pin Count FMC slot
 - FMC_PCIe Gen2 x8 EP cable
 - FPGA PCIe GEN1/2/3 x8 RC slot
 - FPGA Communication ports:
 - 2x SGMII Gigabit Ethernet ports (PHY PN: 88E1111-B2-NDC2C000)
 - 2x 10Gb/s SFP+ ports
 - Display port (DP)
 - SDI/SDO video port
 - SPI port
 - UART port
 - FPGA Debug ports:
 - 16-bit Trace port (FPGA Trace)

- General user I/O
 - LEDs and displays
 - 4x FPGA user LEDs
 - 4x HPS user LEDs
 - Configuration load LED
 - Configuration done LED
 - Error LED
 - 3x Configuration select LEDs
 - 4x On-board USB-Blaster II status LEDs
 - 2x FMC interface LEDs
 - 2x UART data transmit and receive LEDs
 - Power on LED
 - Two-line character LCD display
 - Push buttons
 - CPU cold reset push button and one CPU warm reset push button
 - Logic reset push button
 - Program select push button
 - Program configuration push button
 - 4x FPGA user push buttons
 - 4x HPS user push buttons
 - External interrupt push button
 - DIP Switches
 - JTAG chain control DIP switch
 - Board settings DIP switch
 - FPGA configuration mode DIP switch
 - General user DIP switch
 - Power supply
 - 12V DC Input
 - Mechanical
 - 7.175" x 9.3" rectangular form factor

Recommended Operating Conditions

- Recommended ambient operating temperature range: 0C to 45C
- Maximum ICC load current: 36A
- Maximum ICC load transient percentage: 30%
- FPGA maximum power supported by the supplied heatsink/fan: 40W

Handling the Board

When handling the board, it is important to observe static discharge precautions.

Caution: Without proper anti-static handling, the board can be damaged. Therefore, use anti-static handling precautions when touching the board.

2016.03.01

UG-20004



Subscribe



Send Feedback

Board Inspection

To inspect each board, perform these steps:

1. Place the board on an anti-static surface and inspect it to ensure that it has not been damaged during shipment.

Caution: Without proper anti-static handling, you can damage the board.

2. Verify that all components on the boards appear in place and intact.

For more information about power consumption and thermal modeling, refer to *AN358: Thermal Management for FPGAs*.

Table 2-1: Arria 10 SoC Development Kit Contents

Item	Quantity
Arria 10 SoC Development Board	1
USB Cable Mini	2
USB Cable Micro	1
Ethernet Cable	1
MicroSD Daughtercard	1
Quad SPI Daughtercard	1
NAND Daughtercard	1
DDR4 HILO Memory Card	2
Quick Start Guide	1

Related Information

[AN358: Thermal Management for FPGAs](#)

Installing the Subscription Edition of the Quartus Prime Design Software

The Quartus[®] Prime Pro Edition software provides the necessary tools used for developing hardware and software for Altera devices.

© 2016 Altera Corporation. All rights reserved. ALTERA, ARRIA, CYCLONE, ENPIRION, MAX, MEGACORE, NIOS, QUARTUS and STRATIX words and logos are trademarks of Altera Corporation and registered in the U.S. Patent and Trademark Office and in other countries. All other words and logos identified as trademarks or service marks are the property of their respective holders as described at www.altera.com/common/legal.html. Altera warrants performance of its semiconductor products to current specifications in accordance with Altera's standard warranty, but reserves the right to make changes to any products and services at any time without notice. Altera assumes no responsibility or liability arising out of the application or use of any information, product, or service described herein except as expressly agreed to in writing by Altera. Altera customers are advised to obtain the latest version of device specifications before relying on any published information and before placing orders for products or services.

ISO
9001:2008
Registered



Included in the Quartus Prime Pro Edition software are the Quartus Prime software, the Nios II EDS, and the MegaCore IP Library. To install the Altera development tools, download the Quartus Prime Pro Edition Software from the Quartus Prime Pro Edition page in the Download Center of the Altera website.

Related Information

[Quartus Prime Software page](#)

Activating Your License

Purchasing this kit entitles you to a one-year license for the Development Kit Edition (DKE) of the Quartus Prime software. After the year, your DKE license will no longer be valid and you will not be permitted to use this version of the Quartus Prime software. To continue using the Quartus Prime software, you should purchase a subscription to Quartus Prime Pro or Standard Edition.

Before using the Quartus Prime software, you must activate your license, identify specific users and computers, and obtain and install a license file. If you already have a licensed version of the subscription edition, you can use that license file with this kit. If not, follow these steps:

1. Log on at the [myAltera Account Sign In](#) web page, and click **Sign In**.
2. On the myAltera Home web page, click the Self-Service Licensing Center link.
3. Locate the serial number printed on the side of the development kit box below the bottom bar code. The number consists of alphanumeric characters and does not contain hyphens.
4. On the Self-Service Licensing Center web page, click the Find it with your License Activation Code link.
5. In the **Find/Activate Products** dialog box, enter your development kit serial number and click **Search**.
6. When your product appears, turn on the check box next to the product name.
7. Click **Activate Selected Products**, and click **Close**.
8. When licensing is complete, Altera emails a **license.dat** file to you. Store the file on your computer and use the License Setup page of the **Options** dialog box in the Quartus Prime software to enable the software.

Related Information

- [Altera Software Installation and Licensing](#)
- [myAltera Account Sign In web page](#)

Installing the Altera SoC Embedded Development Suite (EDS)

The Altera SoC EDS is a comprehensive tool suite for embedded software development on Altera SoC devices. It contains development tools, utility programs, run-time software, and application examples to expedite firmware and application software of SoC embedded systems.

As a part of the Altera SoC EDS, the ARM DS-5 Altera Edition Toolkit provides a comprehensive set of embedded development tools for Altera SoCs.

For more information, refer to the *ARM Development Studio 5 (DS-5) Altera Edition Toolkit*.

For the steps to install the SoC EDS Tool Suite, refer to the *Altera SoC Embedded Design Suite User Guide*.

Related Information

- [ARM Development Studio 5 \(DS-5\) Altera Edition Toolkit](#)
- [Altera SoC Embedded Design Suite User Guide](#)

Development Kit Installer

The development kit installer is an installable archive of supporting documentation. It does not include the software or documentation for the Quartus Prime design software, nor does it include the SoC EDS software development tools.

1. Download the Arria 10 FPGA Development Kit installer from the Arria 10 FPGA Development Kit page of the Altera website. Alternatively, you can request a development kit DVD from the Altera Kit Installations DVD Request Form page of the Altera website.
2. Run the Arria 10 FPGA Development Kit installer.
3. Follow the on-screen instructions to complete the installation process. Be sure that the installation directory you choose is in the same relative location to the Quartus Prime software installation. The installation program creates the development kit directory structure shown in the following figure.

Figure 2-1: Installed Development Kit Directory Structure

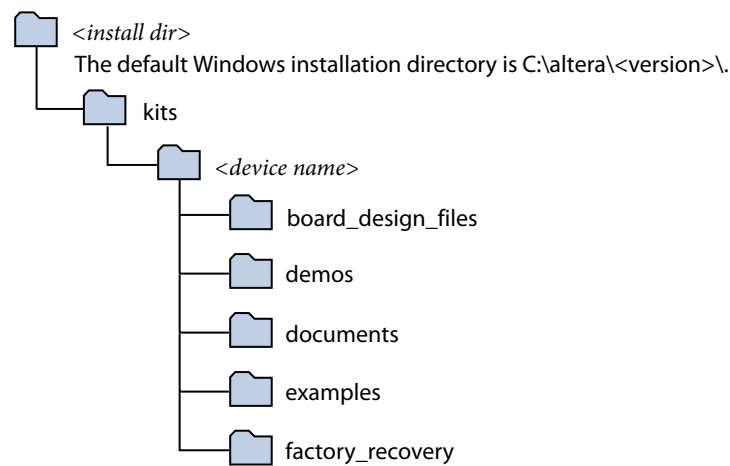

Table 2-2: Installed Directory Contents

Directory Name	Description of Contents
board_design_files	Contains schematic, layout, assembly, and bill of material board design files. Use these files as a starting point for a new prototype board design.
demos	Contains demonstration applications when available.
documents	Contains the documentation.
examples	Contains the sample design files for this kit.
factory_recovery	Contains the original data programmed onto the board before shipment. Use this data to restore the board with its original factory contents.

Installing the USB-Blaster Driver

The development board includes integrated USB-Blaster circuitry for FPGA programming. However, for the host computer and board to communicate, you must install the on-board USB-Blaster II driver on the host computer.

Installation instructions for the on-board USB-Blaster II driver for your operating system are available on the Altera website. On the Altera Programming Cable Driver Information page of the Altera website, locate the table entry for your configuration and click the link to access the instructions.

Related Information

[Altera Programming Cable Driver Information](#)

SD Card Image with Example Software

The Arria 10 GSRD (Golden System Reference Design) page on Rocketboards.org has instructions to create an SD card image.

Related Information

[GSRD User Manual](#)

2016.03.01

UG-20004



Subscribe



Send Feedback

This section describes how to apply power to the board and provides default switch and jumper settings.

Applying Power to the Board

This development kit ships with its board switches preconfigured to support the design examples in the kit.

If you suspect that your board might not be currently configured with the default settings, follow the instructions in the Default Switch and Jumper Settings section of this chapter.

1. Power up the development board by using the included power supply.

Caution: Use only the supplied power supply. Power regulation circuitry on the board can be damaged by power supplies with greater voltage, and a lower-rated power supply may not be able to provide enough power for the board.

2. When configuration is complete, the configuration done green LED (D18) illuminates, signaling that the Arria 10 SoC device is configured successfully.

Default Switch and Jumper Settings

This topic shows you how to restore the default factory settings and explains their functions.

Caution: Do not install or remove jumpers (shunts) while the development board is powered on.

Figure 3-1: Default Switch and Jumper Settings

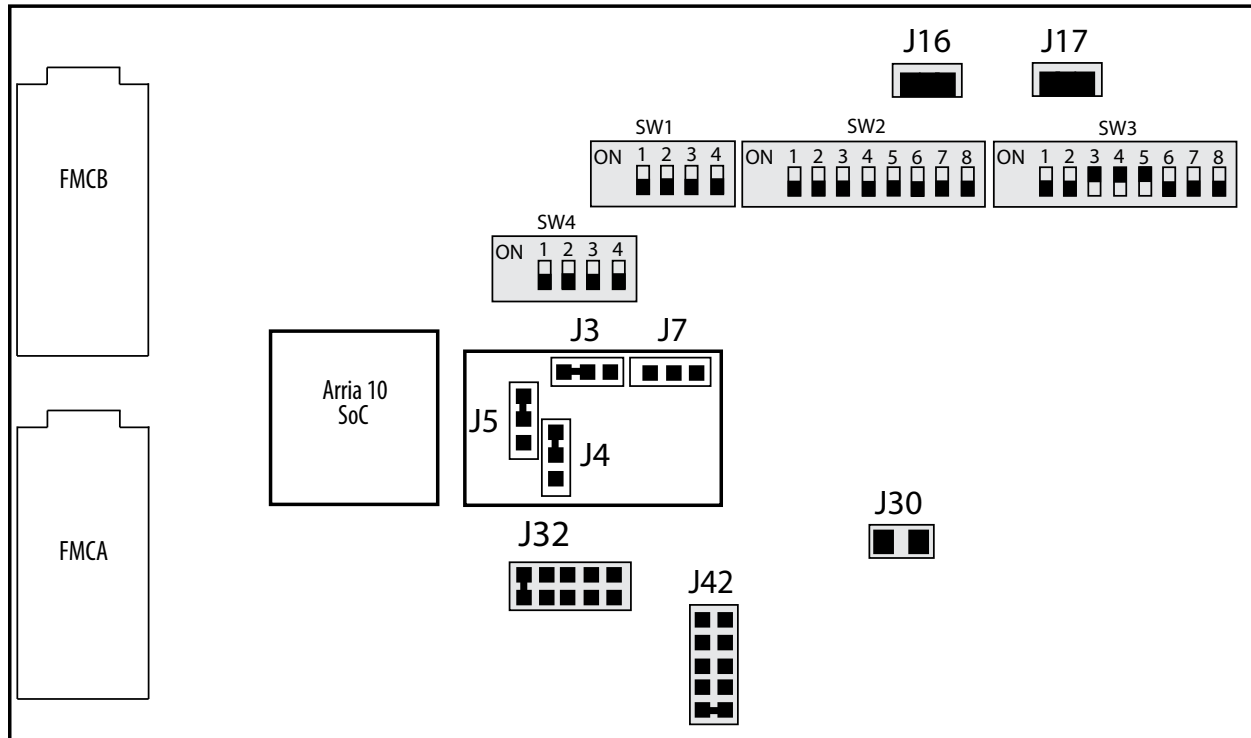

Note: The Switch position is represented by the black box.

To restore the switches to their factory default settings, perform these steps:

1. Set the DIP switch bank (SW1) to match "SW1 DIP Switch Settings" table and the "Default Switch and Jumper Settings" figure.

Note: In the following table, *ON* indicates the switch is to the upper position according to the board orientation as shown in the "Default Switch and Jumper Settings" figure.

Table 3-1: SW1 Factory Default Settings

Switch	Bit Name	Bit Function	Default Position
1	I ² C flag	Switch 1.1 has the following options: <ul style="list-style-type: none"> ON (0) = System MAX V is the I²C master OFF (1) = HPS is the I²C master 	OFF
2	DC_POWER_CTRL	Switch 1.2 has the following options: <ul style="list-style-type: none"> ON (0) = Power off PCIE slot when it is present OFF (1) = Power up PCIE directly 	OFF
3	factory_load	Switch 1.3 has the following options: <ul style="list-style-type: none"> ON (0) = Load user design from flash at power up OFF (1) = Load factory design from flash at power up 	OFF
4	security_mode	Reserved	OFF

Table 3-2: SW4 Switch Settings

Switch	Bit Name	Bit Function	Default Position
1	Reserved	Reserved	OFF
2	MSEL0	Switch 4.2 has the following options: <ul style="list-style-type: none"> ON (Up) = MSEL0 is 1 OFF (Down) = MSEL0 is 0 	OFF
3	MSEL1	Switch 4.3 has the following options: <ul style="list-style-type: none"> ON (Up) = MSEL1 is 1 OFF (Down) = MSEL1 is 0 	OFF
4	MSEL2	Switch 4.4 has the following options: <ul style="list-style-type: none"> ON (Up) = MSEL2 is 1 OFF (Down) = MSEL2 is 0 	OFF

Table 3-3: MSEL Settings for each Configuration Scheme of Arria 10 SoC Devices

Configuration	V _{ccpgm} (V)	Power-On Reset (POR delay)	Valid MSEL [2:0]
JTAG-based configuration	-	-	Use any valid MSEL pin settings below
AS-Active Serial (x1 and x4)	1.8	Fast	010
		Standard	011
PS-Passive Serial	1.2/1.5/1.8	Fast	000
		Standard	001

- Set the DIP switch bank (SW3) to match the following tables:

Table 3-4: SW3 Factory Default Settings

Switch	Board Label	Function	Default Position
1	Arria 10	ON- Arria 10 JTAG Bypass OFF- Arria 10 JTAG Enable	OFF
2	IO MAX V	ON- MAX V JTAG Bypass OFF- MAX V JTAG Enable	OFF
3	FMCA	ON- FMCA JTAG Bypass OFF- FMCA JTAG Enable	ON
4	FMCB	ON- FMCB JTAG Bypass OFF- FMCB JTAG Enable	ON
5	PCIe	ON- PCIe JTAG Bypass OFF- PCIe JTAG Enable	ON
6	MSTR0	On-Board USB Blaster II JTAG Master	OFF
7	MSTR1	On-Board USB Blaster II JTAG Master	OFF
8	MSTR2	On-Board USB Blaster II JTAG Master	OFF

3. Set the following jumper blocks to match the table below:

Table 3-5: Default Jumper Settings

Board Reference	Board Label	Description	Default Position
J16, J17	OSC2_CLK_SEL	<ul style="list-style-type: none"> 00 (SHORT, SHORT): Selects the on-board 25MHz clock 01 (SHORT, OPEN): Selects SMA clock which connected to J15 10 (OPEN, SHORT): Selects the on-board 33MHz clock 11 (OPEN, OPEN): none 	SHORT, SHORT
J30	HPS Core Voltage	<ul style="list-style-type: none"> SHORT: HPS core 0.95 V OPEN: HPS core 0.9 V 	OPEN
J32	Voltage of FMCBVADJ	<ul style="list-style-type: none"> No SHORT: 1.1 V SHORT 1 and 2: 1.2 V SHORT 3 and 4: 1.25 V SHORT 5 and 6: 1.35 V SHORT 7 and 8: 1.5 V SHORT 9 and 10: 1.8 V 	SHORT 9 and 10
J42	Voltage of FMCAVADJ	<ul style="list-style-type: none"> No SHORT: 1.1 V SHORT 1 and 2: 1.1 V SHORT 3 and 4: 1.2 V SHORT 5 and 6: 1.35 V SHORT 7 and 8: 1.5 V SHORT 9 and 10: 1.8 V 	SHORT 9 and 10

Table 3-6: Default Jumper BSEL Settings for Micro-SD Daughtercard

Board Reference	Description	Default Position
J3	BSEL0	SHORT left 2 pins
J4	BSEL1	SHORT upper 2 pins ⁽¹⁾
J5	BSEL2	SHORT upper 2 pins ⁽¹⁾

Related Information

[Board Settings DIP Switch](#) on page 5-19

⁽¹⁾ The directions of these pins are in reference to the board arrangement as in the "Default Switch and Jumper Settings" figure.

2016.03.01

UG-20004



Subscribe



Send Feedback

This kit includes an application called the Board Test System (BTS). The BTS provides an easy-to-use interface to alter functional settings and observe the results.

Figure 4-1: Board Test System GUI

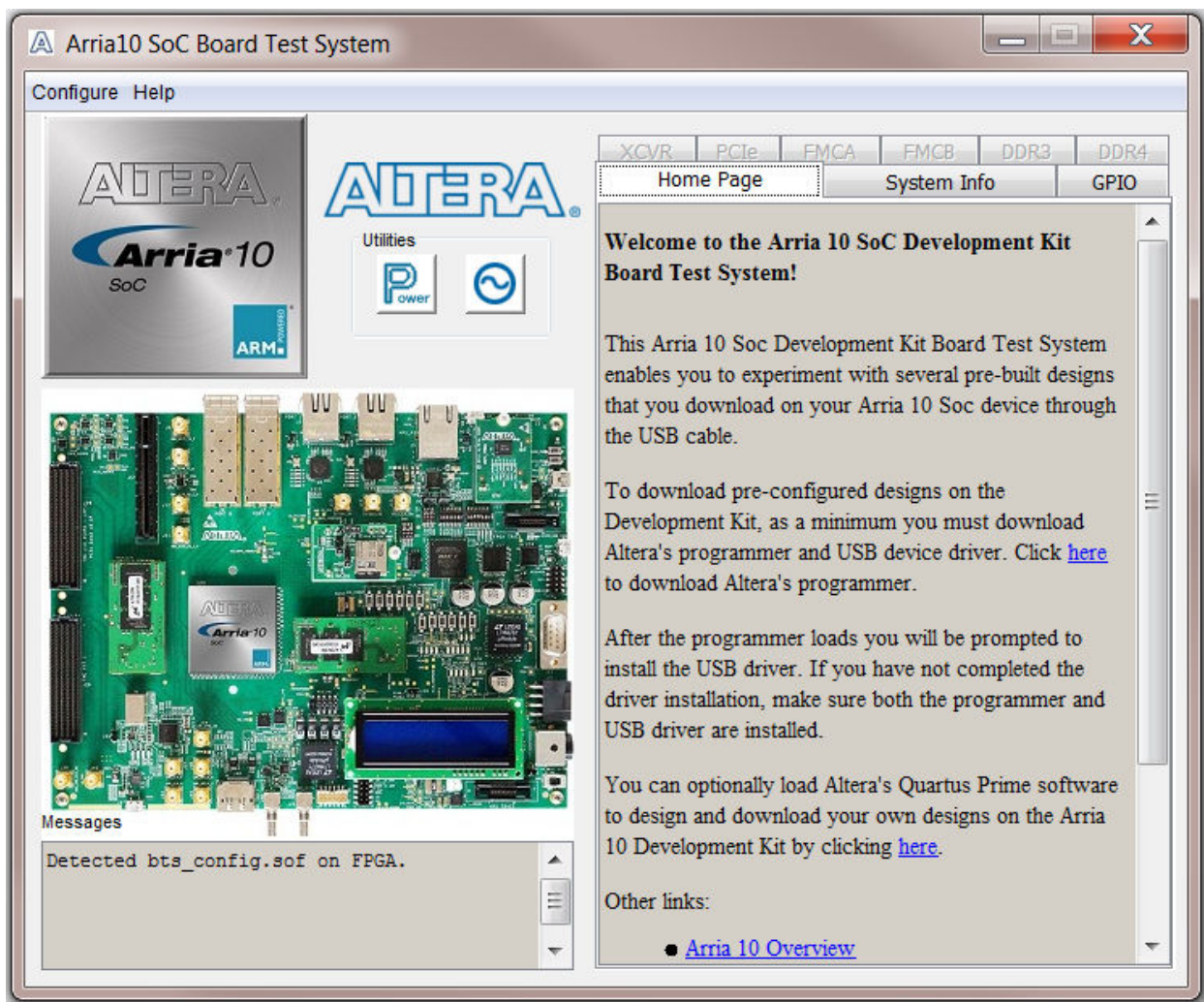

© 2016 Altera Corporation. All rights reserved. ALTERA, ARRIA, CYCLONE, ENPIRION, MAX, MEGACORE, NIOS, QUARTUS and STRATIX words and logos are trademarks of Altera Corporation and registered in the U.S. Patent and Trademark Office and in other countries. All other words and logos identified as trademarks or service marks are the property of their respective holders as described at www.altera.com/common/legal.html. Altera warrants performance of its semiconductor products to current specifications in accordance with Altera's standard warranty, but reserves the right to make changes to any products and services at any time without notice. Altera assumes no responsibility or liability arising out of the application or use of any information, product, or service described herein except as expressly agreed to in writing by Altera. Altera customers are advised to obtain the latest version of device specifications before relying on any published information and before placing orders for products or services.

ISO
9001:2008
Registered

You can use the BTS to test board components, modify functional parameters, observe performance, and measure power usage. While using the BTS, you reconfigure the FPGA several times with test designs specific to the functionality you are testing.

Several designs are provided to test the major board features. Each design provides data for one or more tabs in the application. The Configure menu identifies the appropriate design to download to the FPGA for each tab.

After successful FPGA configuration, the appropriate tab appears that allows you to exercise the related board features. Highlights appear in the board picture around the corresponding components.

The BTS communicates over the JTAG bus to a test design running in the FPGA. The Board Test System and Power Monitor share the JTAG bus with other applications like the Nios II debugger and the SignalTap® II Embedded Logic Analyzer.

Note: Because the BTS is designed based on the Quartus Prime Programmer and system console, be sure to close the other applications before you use the BTS application.

Preparing the Board

After successful FPGA configuration, follow these steps:

1. Connect the USB cable to your PC and the USB Blaster II port.
2. Change SW1 and SW3 to the following configuration:

Table 4-1: SW1 GUI Mode

Bit1	Bit2	Bit3	Bit4
ON	OFF	OFF	OFF

Table 4-2: SW3 GUI Mode

Bit1	Bit2	Bit3	Bit4	Bit5	Bit6	Bit7	Bit8
OFF	OFF	ON	ON	ON	OFF	ON	OFF

3. Run the BTS with Quartus Prime 15.1 Programmer.

The application cannot run correctly unless Quartus Prime 15.1 Programmer is opened.

Note: Do not use the Auto Detect function in the Quartus Prime Programmer. It may cause the board power to reset.

Running the Board Test System

To run the Board Test System (BTS), navigate to the **<Package Root Dir>\examples\board_test_system** directory and run the **BoardTestSystem.exe** application.

On Windows, you can also run the BTS from the **Start > All Programs > Altera** menu.

The BTS relies on the Quartus Prime software's specific library. Before running the BTS, open the Quartus Prime software to automatically set the environment variable `$QUARTUS_ROOTDIR`. The Board Test System uses this environment variable to locate the Quartus Prime library.

Note: The version of Quartus Prime software set in the `$QUARTUS_ROOTDIR` environment variable should be version 14.1 or later.

Using the Board Test System

This section describes each control in the Board Test System application.

Using the Configure Menu

Use the Configure menu to select the design you want to use. Each design example tests different board features. Choose a design from this menu and the corresponding tabs become active for testing.

Figure 4-2: The Configure Menu

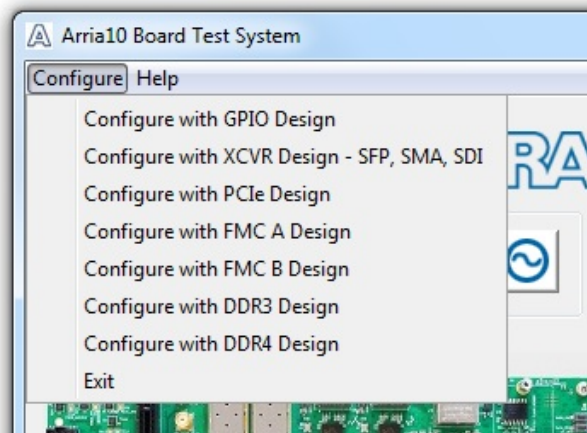

To configure the FPGA with a test system design, perform the following steps:

1. On the **Configure** menu, click the configure command that corresponds to the functionality you wish to test.
2. In the dialog box that appears, click **Configure** to download the corresponding design to the FPGA.

Figure 4-3: Programmer Dialog Window

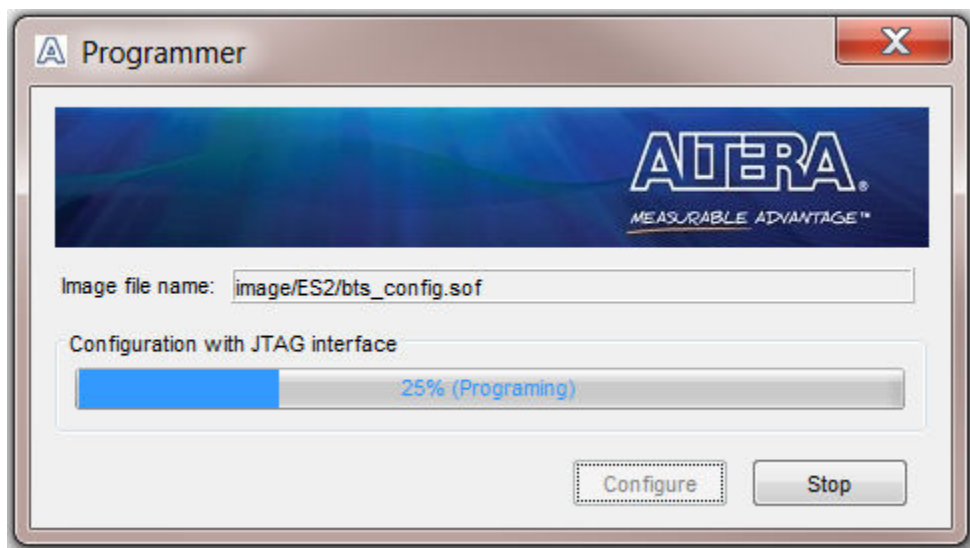

The System Info Tab

The System Info tab shows the board's current configuration. The tab displays the JTAG chain, the Qsys memory map, and other details stored on the board.

Figure 4-4: The System Info Tab

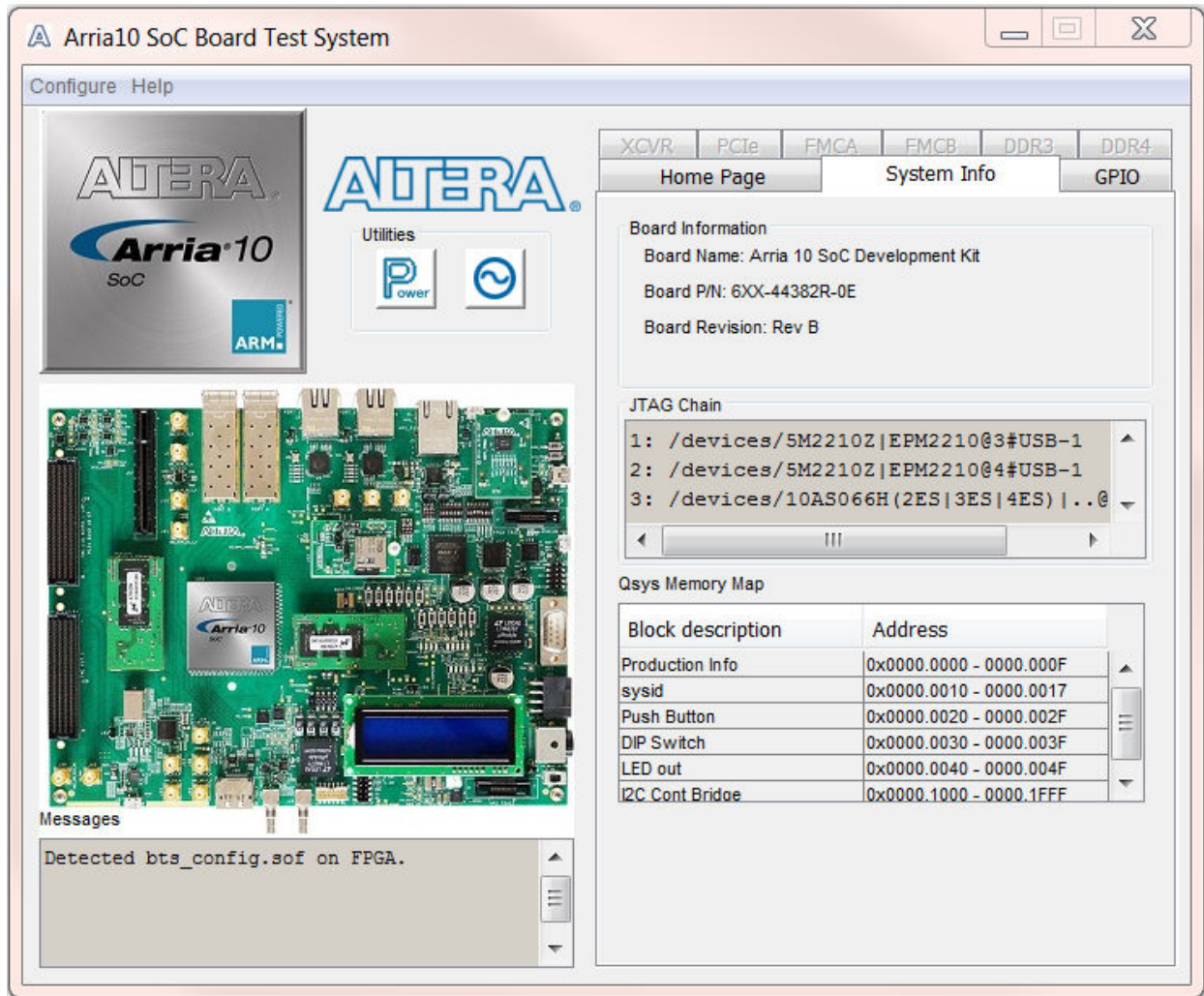

Table 4-3: Controls on the System Info Tab

Controls	Description
Board Information	The board information is updated once the GPIO design is configured. Otherwise, this control displays the default static information about your board.
Board Name	Indicates the official name of the board, given by the Board Test System.
Board P/N	Indicates the part number of the board.
Serial Number	Indicates the serial number of the board.

Controls	Description
Factory Test Version	Indicates the version of the Board Test System currently running on the board.
JTAG Chain	Shows all the devices currently in the JTAG chain.
Qsys Memory Map	Shows the memory map of the Qsys system on your board.

The GPIO Tab

The GPIO tab allows you to interact with all the general purpose user I/O components on your board. You can read DIP switch settings, turn LEDs on or off, and detect push button presses.

Figure 4-5: The GPIO Tab

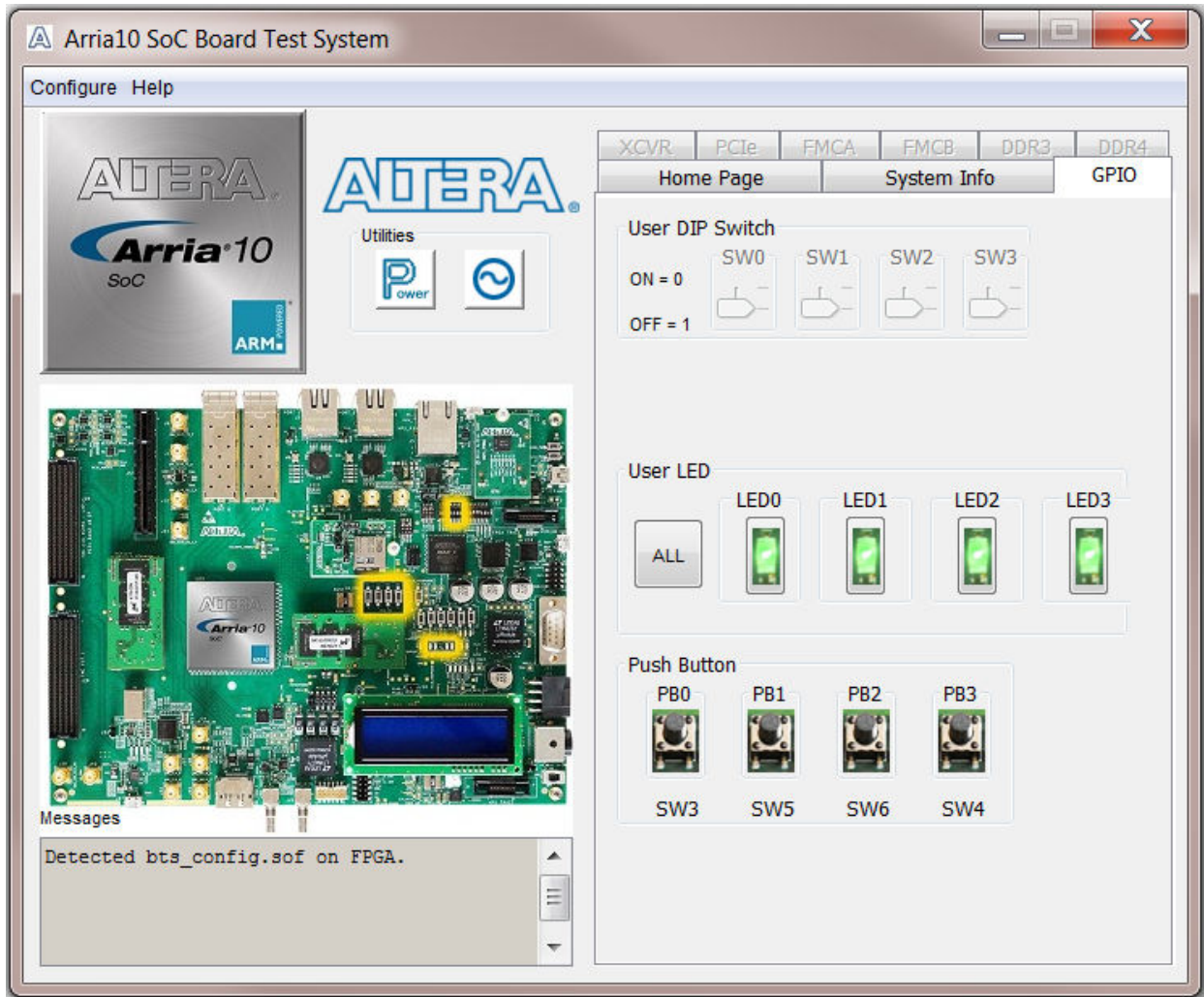

Table 4-4: Controls on the GPIO Tab

User DIP Switch	Displays the current positions of the switches in the user DIP switch bank (SW2). Change the switches on the board to see the graphical display change accordingly.
User LEDs	Displays the current state of the user LEDs for the FPGA. To toggle the board LEDs, click one of the LED [0 to 3] buttons to toggle the 4 green LEDs, or click the All button.

Push Button Switches

Read-only control displays the current state of the board user push buttons. Press a push button on the board to see the graphical display change accordingly.

The XCVR Tab

This tab allows you to perform loopback tests on the QSFP, SFP, SMA, and SDI ports.

Figure 4-6: The XCVR Tab

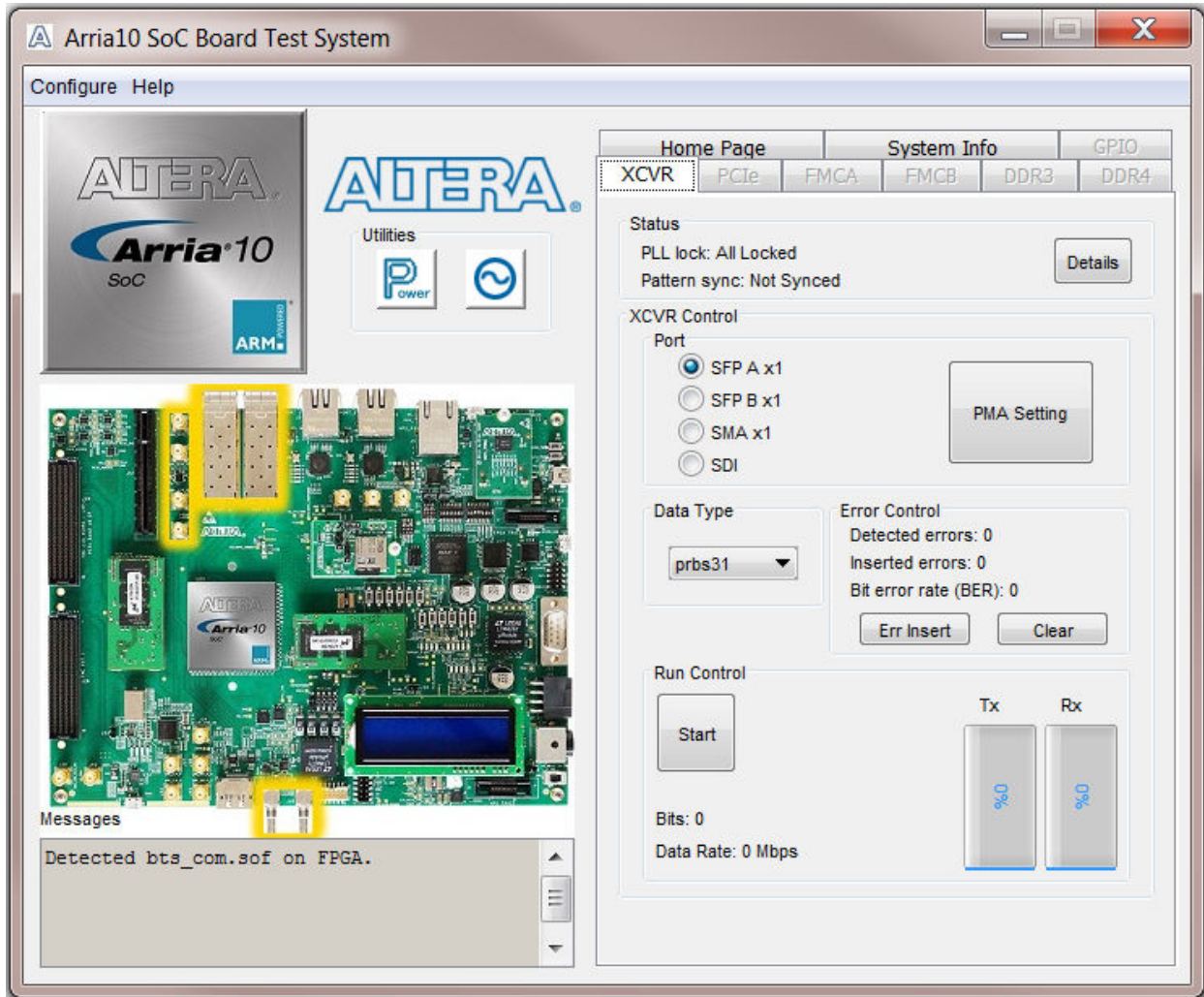

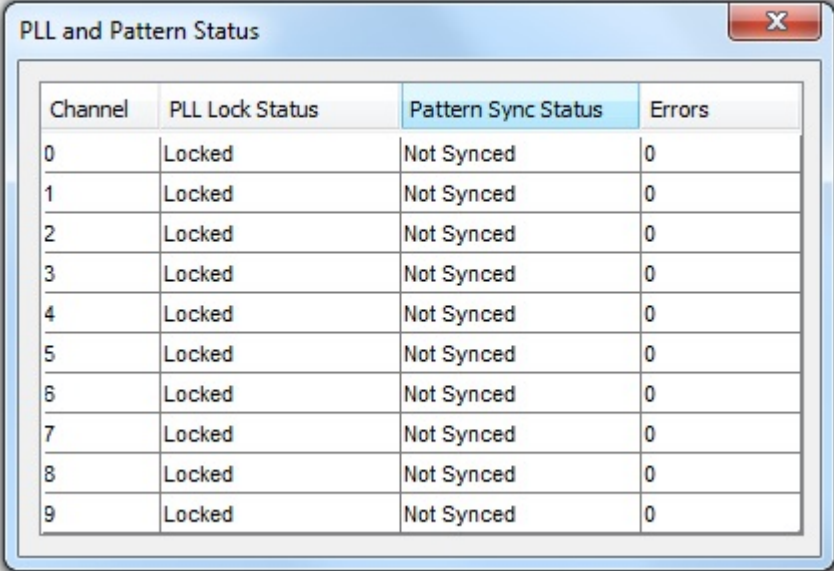
Control	Description																																												
Status	<p>Displays the following status information during a loopback test:</p> <p>PLL lock—Shows the PLL locked or unlocked state.</p> <p>Pattern sync—Shows the pattern synced or not synced state. The pattern is considered synced when the start of the data sequence is detected.</p> <p>Details—Shows the PLL lock and pattern sync status, and detected errors of each channels.:</p>  <table border="1" data-bbox="558 548 1360 1016"> <thead> <tr> <th>Channel</th> <th>PLL Lock Status</th> <th>Pattern Sync Status</th> <th>Errors</th> </tr> </thead> <tbody> <tr><td>0</td><td>Locked</td><td>Not Synced</td><td>0</td></tr> <tr><td>1</td><td>Locked</td><td>Not Synced</td><td>0</td></tr> <tr><td>2</td><td>Locked</td><td>Not Synced</td><td>0</td></tr> <tr><td>3</td><td>Locked</td><td>Not Synced</td><td>0</td></tr> <tr><td>4</td><td>Locked</td><td>Not Synced</td><td>0</td></tr> <tr><td>5</td><td>Locked</td><td>Not Synced</td><td>0</td></tr> <tr><td>6</td><td>Locked</td><td>Not Synced</td><td>0</td></tr> <tr><td>7</td><td>Locked</td><td>Not Synced</td><td>0</td></tr> <tr><td>8</td><td>Locked</td><td>Not Synced</td><td>0</td></tr> <tr><td>9</td><td>Locked</td><td>Not Synced</td><td>0</td></tr> </tbody> </table>	Channel	PLL Lock Status	Pattern Sync Status	Errors	0	Locked	Not Synced	0	1	Locked	Not Synced	0	2	Locked	Not Synced	0	3	Locked	Not Synced	0	4	Locked	Not Synced	0	5	Locked	Not Synced	0	6	Locked	Not Synced	0	7	Locked	Not Synced	0	8	Locked	Not Synced	0	9	Locked	Not Synced	0
Channel	PLL Lock Status	Pattern Sync Status	Errors																																										
0	Locked	Not Synced	0																																										
1	Locked	Not Synced	0																																										
2	Locked	Not Synced	0																																										
3	Locked	Not Synced	0																																										
4	Locked	Not Synced	0																																										
5	Locked	Not Synced	0																																										
6	Locked	Not Synced	0																																										
7	Locked	Not Synced	0																																										
8	Locked	Not Synced	0																																										
9	Locked	Not Synced	0																																										
Port	<p>Allows you to specify which interface to test. The following port tests are available:</p> <ul style="list-style-type: none"> SFP A x1 SFP B x1 SMA x1 SDI 																																												

Control	Description
PMA Setting	<p>Allows you to make changes to the PMA parameters that affect the active transceiver interface. The following settings are available for analysis:</p> <p>Serial Loopback—Routes signals between the transmitter and the receiver.</p> <p>VOD—Specifies the voltage output differential of the transmitter buffer.</p> <p>Pre-emphasis tap</p> <ul style="list-style-type: none"> 1st pre—Specifies the amount of pre-emphasis on the pre-tap of the transmitter buffer. 2nd pre—Specifies the amount of pre-emphasis on the second pre-tap of the transmitter buffer. 1st post—Specifies the amount of pre-emphasis on the first post tap of the transmitter buffer. 2nd post—Specifies the amount of pre-emphasis on the second post tap of the transmitter buffer. <p>Equalizer—Specifies the AC gain setting for the receiver equalizer in four stage mode.</p> <p>DC gain—Specifies the DC gain setting for the receiver equalizer in four stage mode.</p> <p>VGA—Specifies the VGA gain value.</p>

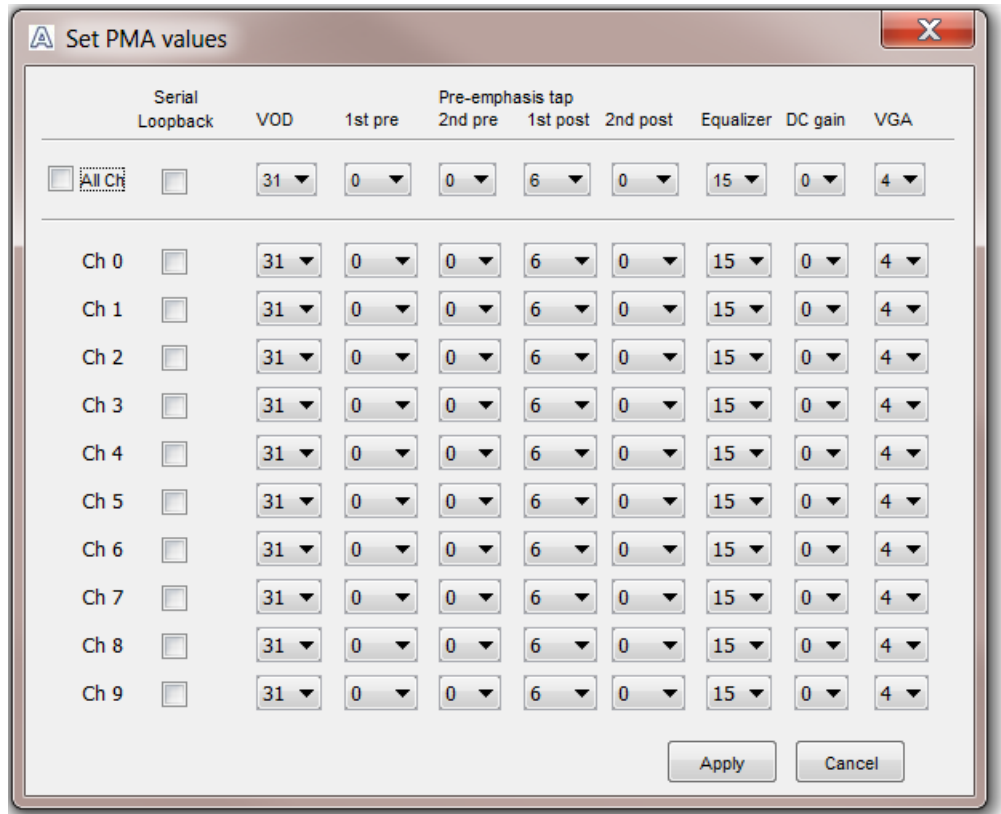

Control	Description
Data Type	<p>Specifies the type of data contained in the transactions. The following data types are available for analysis:</p> <ul style="list-style-type: none"> • PRBS 7—Selects pseudo-random 7-bit sequences. • PRBS 15—Selects pseudo-random 15-bit sequences. • PRBS 23—Selects pseudo-random 23-bit sequences. • PRBS 31—Selects pseudo-random 31-bit sequences. • HF—Selects highest frequency divide-by-2 data pattern 10101010. • LF—Selects lowest frequency divide-by-33 data pattern.
Error Control	<p>Displays data errors detected during analysis and allows you to insert errors:</p> <ul style="list-style-type: none"> • Detected errors—Displays the number of data errors detected in the hardware. • Inserted errors—Displays the number of errors inserted into the transmit data stream. • Insert Error—Inserts a one-word error into the transmit data stream each time you click the button. Insert Error is only enabled during transaction performance analysis. • Clear—Resets the Detected errors and Inserted errors counters to zeroes.
Run Control	<p>Start—Initiates the selected ports transaction performance analysis.</p> <p>Note: Always click Clear before Start.</p> <p>Stop—Terminates transaction performance analysis.</p> <p>TX and RX performance bars—Show the percentage of maximum theoretical data rate that the requested transactions are able to achieve.</p>

The PCIe Tab

This tab allows you to run a PCIe loopback test on your board. You can also load the design and use an oscilloscope to measure an eye diagram of the PCIe transmit signals.

Figure 4-7: The PCIe Tab

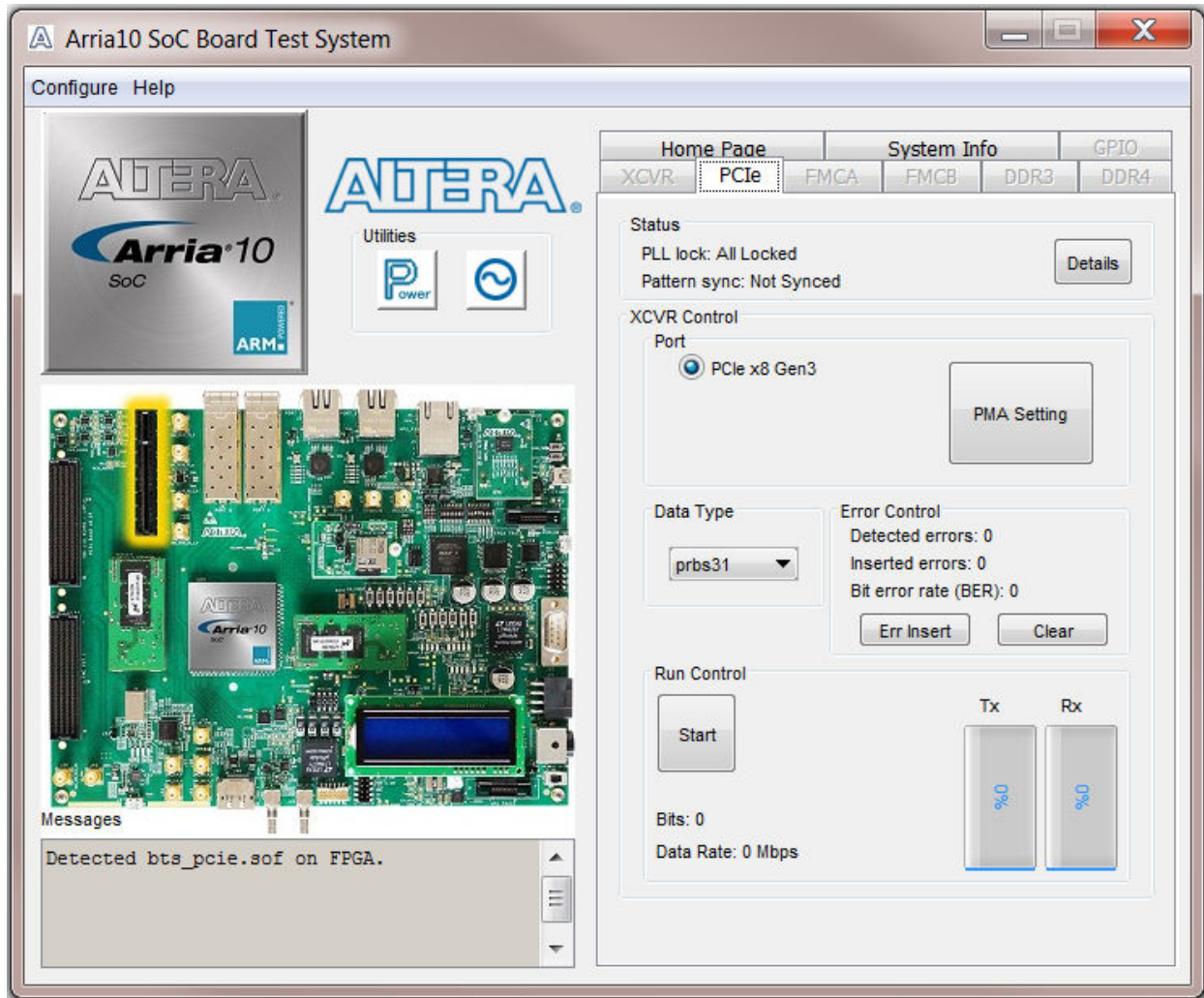

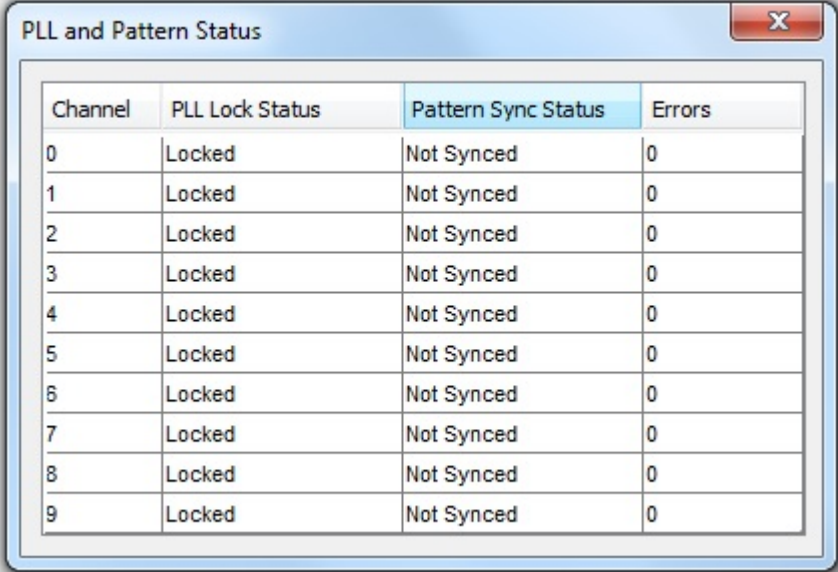
Control	Description																																												
<p>Status</p>	<p>Displays the following status information during a loopback test:</p> <p>PLL lock—Shows the PLL locked or unlocked state.</p> <p>Pattern sync—Shows the pattern synced or not synced state. The pattern is considered synced when the start of the data sequence is detected.</p> <p>Details—Shows the PLL lock and pattern sync status:</p>  <table border="1" data-bbox="618 485 1451 1052"> <caption>PLL and Pattern Status</caption> <thead> <tr> <th>Channel</th> <th>PLL Lock Status</th> <th>Pattern Sync Status</th> <th>Errors</th> </tr> </thead> <tbody> <tr><td>0</td><td>Locked</td><td>Not Synced</td><td>0</td></tr> <tr><td>1</td><td>Locked</td><td>Not Synced</td><td>0</td></tr> <tr><td>2</td><td>Locked</td><td>Not Synced</td><td>0</td></tr> <tr><td>3</td><td>Locked</td><td>Not Synced</td><td>0</td></tr> <tr><td>4</td><td>Locked</td><td>Not Synced</td><td>0</td></tr> <tr><td>5</td><td>Locked</td><td>Not Synced</td><td>0</td></tr> <tr><td>6</td><td>Locked</td><td>Not Synced</td><td>0</td></tr> <tr><td>7</td><td>Locked</td><td>Not Synced</td><td>0</td></tr> <tr><td>8</td><td>Locked</td><td>Not Synced</td><td>0</td></tr> <tr><td>9</td><td>Locked</td><td>Not Synced</td><td>0</td></tr> </tbody> </table>	Channel	PLL Lock Status	Pattern Sync Status	Errors	0	Locked	Not Synced	0	1	Locked	Not Synced	0	2	Locked	Not Synced	0	3	Locked	Not Synced	0	4	Locked	Not Synced	0	5	Locked	Not Synced	0	6	Locked	Not Synced	0	7	Locked	Not Synced	0	8	Locked	Not Synced	0	9	Locked	Not Synced	0
Channel	PLL Lock Status	Pattern Sync Status	Errors																																										
0	Locked	Not Synced	0																																										
1	Locked	Not Synced	0																																										
2	Locked	Not Synced	0																																										
3	Locked	Not Synced	0																																										
4	Locked	Not Synced	0																																										
5	Locked	Not Synced	0																																										
6	Locked	Not Synced	0																																										
7	Locked	Not Synced	0																																										
8	Locked	Not Synced	0																																										
9	Locked	Not Synced	0																																										
<p>Port</p>	<p>PCIe x8 Gen3</p>																																												
<p>PMA Setting</p>	<p>Allows you to make changes to the PMA parameters that affect the active transceiver interface. The following settings are available for analysis:</p> <p>Serial Loopback—Routes signals between the transmitter and the receiver.</p> <p>VOD—Specifies the voltage output differential of the transmitter buffer.</p> <p>Pre-emphasis tap</p> <ul style="list-style-type: none"> • 1st pre—Specifies the amount of pre-emphasis on the pre-tap of the transmitter buffer. • 2nd pre—Specifies the amount of pre-emphasis on the second pre-tap of the transmitter buffer. • 1st post—Specifies the amount of pre-emphasis on the first post tap of the transmitter buffer. • 2nd post—Specifies the amount of pre-emphasis on the second post tap of the transmitter buffer. <p>Equalizer—Specifies the setting for the receiver equalizer.</p> <p>DC gain—Specifies the DC portion of the receiver equalizer.</p>																																												

Control	Description
Data Type	<p>Specifies the type of data contained in the transactions. The following data types are available for analysis:</p> <ul style="list-style-type: none">• PRBS 7—Selects pseudo-random 7-bit sequences.• PRBS 15—Selects pseudo-random 15-bit sequences.• PRBS 23—Selects pseudo-random 23-bit sequences.• PRBS 31—Selects pseudo-random 31-bit sequences.• HF—Selects highest frequency divide-by-2 data pattern 10101010.• LF—Selects lowest frequency divide-by-33 data pattern.
Error Control	<p>Displays data errors detected during analysis and allows you to insert errors:</p> <ul style="list-style-type: none">• Detected errors—Displays the number of data errors detected in the hardware.• Inserted errors—Displays the number of errors inserted into the transmit data stream.• Insert Error—Inserts a one-word error into the transmit data stream each time you click the button. Insert Error is only enabled during transaction performance analysis.• Clear—Resets the Detected errors and Inserted errors counters to zeroes.
Run Control	<p>Start—Initiates the selected ports transaction performance analysis.</p> <p>Note: Always click Clear before Start.</p> <p>Stop—Terminates transaction performance analysis.</p> <p>TX and RX performance bars—Show the percentage of maximum theoretical data rate that the requested transactions are able to achieve.</p>

The FMCA Tab

This tab allows you to perform loopback tests on the FMC A port.

Figure 4-8: The FMC A Tab

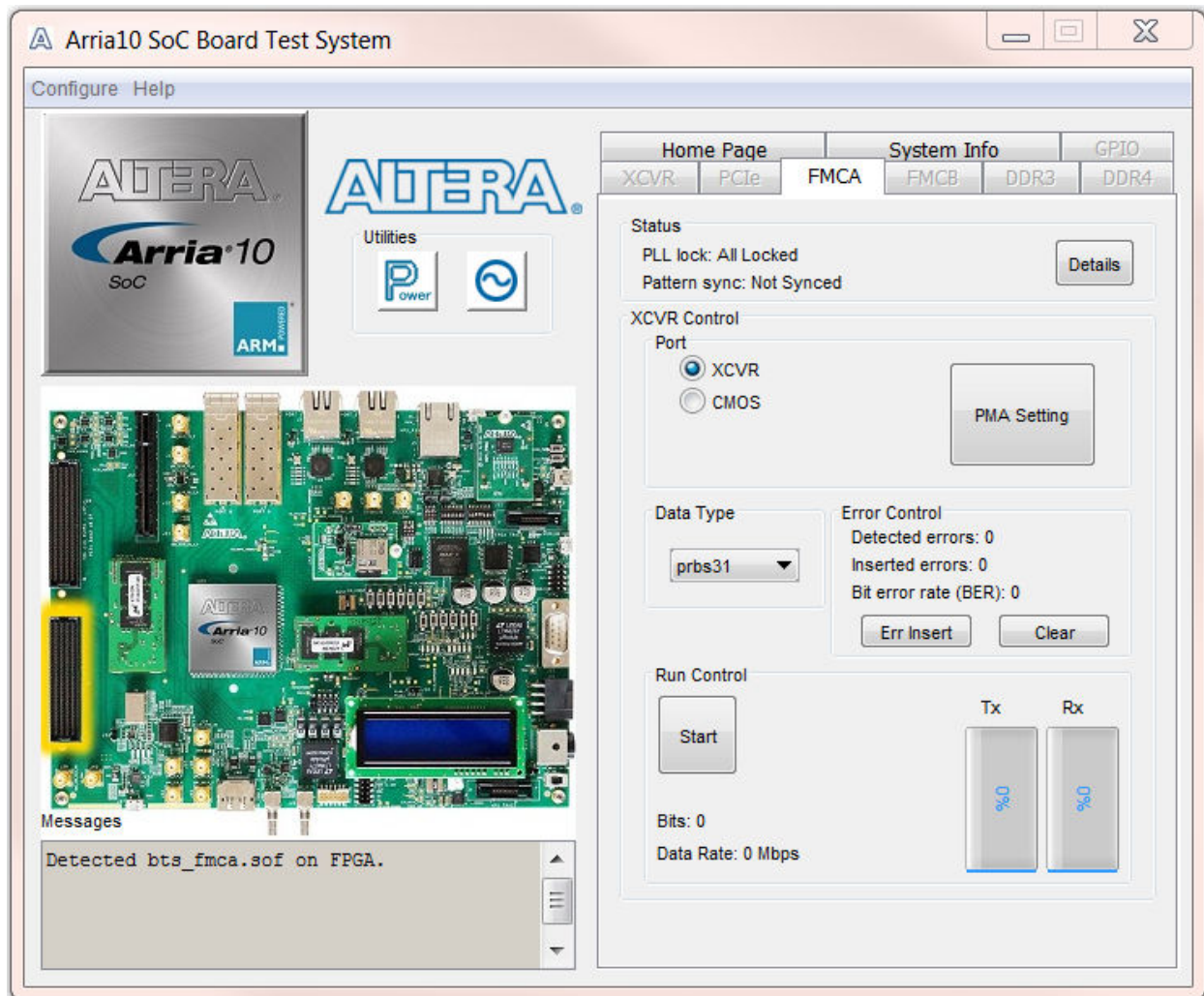

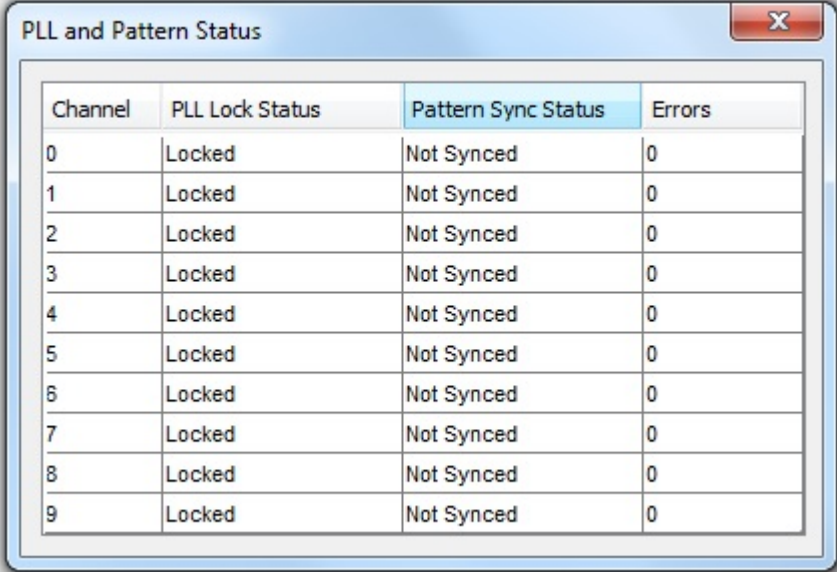
Control	Description																																												
<p>Status</p>	<p>Displays the following status information during a loopback test:</p> <p>PLL lock—Shows the PLL locked or unlocked state.</p> <p>Pattern sync—Shows the pattern synced or not synced state. The pattern is considered synced when the start of the data sequence is detected.</p> <p>Details—Shows the PLL lock and pattern sync status:</p>  <table border="1" data-bbox="618 485 1450 1052"> <caption>PLL and Pattern Status</caption> <thead> <tr> <th>Channel</th> <th>PLL Lock Status</th> <th>Pattern Sync Status</th> <th>Errors</th> </tr> </thead> <tbody> <tr><td>0</td><td>Locked</td><td>Not Synced</td><td>0</td></tr> <tr><td>1</td><td>Locked</td><td>Not Synced</td><td>0</td></tr> <tr><td>2</td><td>Locked</td><td>Not Synced</td><td>0</td></tr> <tr><td>3</td><td>Locked</td><td>Not Synced</td><td>0</td></tr> <tr><td>4</td><td>Locked</td><td>Not Synced</td><td>0</td></tr> <tr><td>5</td><td>Locked</td><td>Not Synced</td><td>0</td></tr> <tr><td>6</td><td>Locked</td><td>Not Synced</td><td>0</td></tr> <tr><td>7</td><td>Locked</td><td>Not Synced</td><td>0</td></tr> <tr><td>8</td><td>Locked</td><td>Not Synced</td><td>0</td></tr> <tr><td>9</td><td>Locked</td><td>Not Synced</td><td>0</td></tr> </tbody> </table>	Channel	PLL Lock Status	Pattern Sync Status	Errors	0	Locked	Not Synced	0	1	Locked	Not Synced	0	2	Locked	Not Synced	0	3	Locked	Not Synced	0	4	Locked	Not Synced	0	5	Locked	Not Synced	0	6	Locked	Not Synced	0	7	Locked	Not Synced	0	8	Locked	Not Synced	0	9	Locked	Not Synced	0
Channel	PLL Lock Status	Pattern Sync Status	Errors																																										
0	Locked	Not Synced	0																																										
1	Locked	Not Synced	0																																										
2	Locked	Not Synced	0																																										
3	Locked	Not Synced	0																																										
4	Locked	Not Synced	0																																										
5	Locked	Not Synced	0																																										
6	Locked	Not Synced	0																																										
7	Locked	Not Synced	0																																										
8	Locked	Not Synced	0																																										
9	Locked	Not Synced	0																																										
<p>Port</p>	<p>Allows you to specify which interface to test. The following port tests are available:</p> <p>XCVR</p> <p>CMOS</p>																																												

Control	Description
PMA Setting	<p>Allows you to make changes to the PMA parameters that affect the active transceiver interface. The following settings are available for analysis:</p> <p>Serial Loopback—Routes signals between the transmitter and the receiver.</p> <p>VOD—Specifies the voltage output differential of the transmitter buffer.</p> <p>Pre-emphasis tap</p> <ul style="list-style-type: none"> • 1st pre—Specifies the amount of pre-emphasis on the pre-tap of the transmitter buffer. • 2nd pre—Specifies the amount of pre-emphasis on the second pre-tap of the transmitter buffer. • 1st post—Specifies the amount of pre-emphasis on the first post tap of the transmitter buffer. • 2nd post—Specifies the amount of pre-emphasis on the second post tap of the transmitter buffer. <p>Equalizer—Specifies the setting for the receiver equalizer.</p> <p>DC gain—Specifies the DC portion of the receiver equalizer.</p>
Data Type	<p>Specifies the type of data contained in the transactions. The following data types are available for analysis:</p> <ul style="list-style-type: none"> • PRBS 7—Selects pseudo-random 7-bit sequences. • PRBS 15—Selects pseudo-random 15-bit sequences. • PRBS 23—Selects pseudo-random 23-bit sequences. • PRBS 31—Selects pseudo-random 31-bit sequences. • HF—Selects highest frequency divide-by-2 data pattern 10101010. • LF—Selects lowest frequency divide-by-33 data pattern.
Error Control	<p>Displays data errors detected during analysis and allows you to insert errors:</p> <ul style="list-style-type: none"> • Detected errors—Displays the number of data errors detected in the hardware. • Inserted errors—Displays the number of errors inserted into the transmit data stream. • Insert Error—Inserts a one-word error into the transmit data stream each time you click the button. Insert Error is only enabled during transaction performance analysis. • Clear—Resets the Detected errors and Inserted errors counters to zeroes.

Control	Description
Run Control	<p>Start—Initiates the selected ports transaction performance analysis.</p> <p>Note: Always click Clear before Start.</p> <p>Stop—Terminates transaction performance analysis.</p> <p>TX and RX performance bars—Show the percentage of maximum theoretical data rate that the requested transactions are able to achieve.</p>

The FMCB Tab

This tab allows you to perform loopback tests on the FMC B port.

Figure 4-9: The FMC B Tab

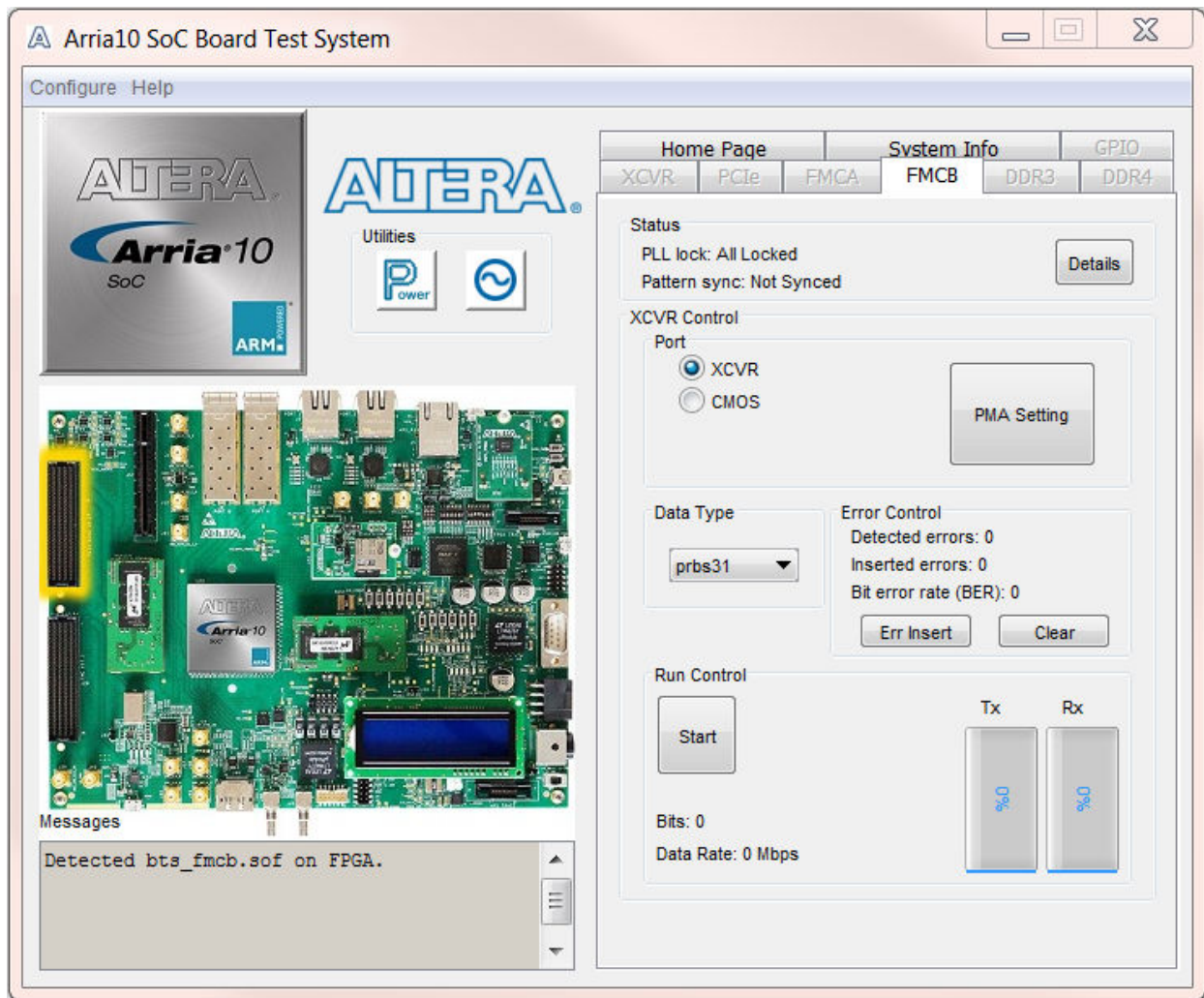

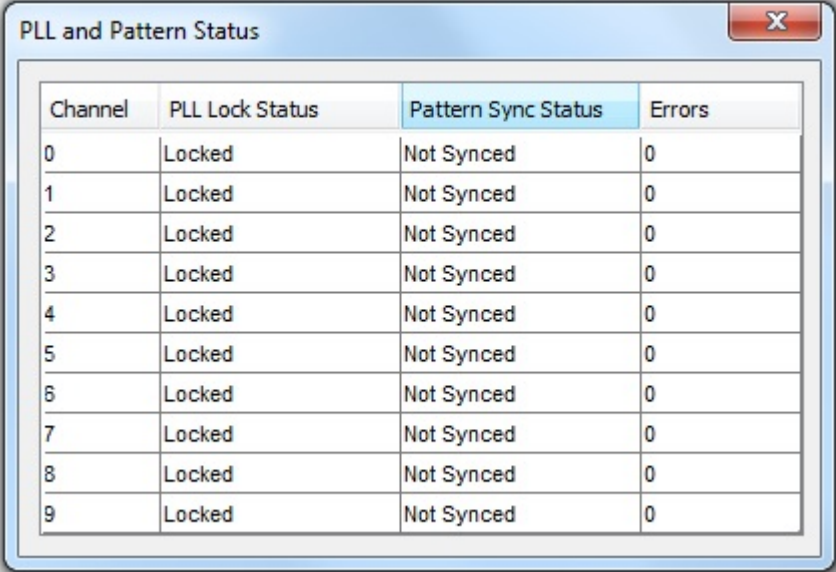
Control	Description																																												
<p>Status</p>	<p>Displays the following status information during a loopback test:</p> <p>PLL lock—Shows the PLL locked or unlocked state.</p> <p>Pattern sync—Shows the pattern synced or not synced state. The pattern is considered synced when the start of the data sequence is detected.</p> <p>Details—Shows the PLL lock and pattern sync status:</p>  <table border="1" data-bbox="620 485 1451 1052"> <caption>PLL and Pattern Status</caption> <thead> <tr> <th>Channel</th> <th>PLL Lock Status</th> <th>Pattern Sync Status</th> <th>Errors</th> </tr> </thead> <tbody> <tr><td>0</td><td>Locked</td><td>Not Synced</td><td>0</td></tr> <tr><td>1</td><td>Locked</td><td>Not Synced</td><td>0</td></tr> <tr><td>2</td><td>Locked</td><td>Not Synced</td><td>0</td></tr> <tr><td>3</td><td>Locked</td><td>Not Synced</td><td>0</td></tr> <tr><td>4</td><td>Locked</td><td>Not Synced</td><td>0</td></tr> <tr><td>5</td><td>Locked</td><td>Not Synced</td><td>0</td></tr> <tr><td>6</td><td>Locked</td><td>Not Synced</td><td>0</td></tr> <tr><td>7</td><td>Locked</td><td>Not Synced</td><td>0</td></tr> <tr><td>8</td><td>Locked</td><td>Not Synced</td><td>0</td></tr> <tr><td>9</td><td>Locked</td><td>Not Synced</td><td>0</td></tr> </tbody> </table>	Channel	PLL Lock Status	Pattern Sync Status	Errors	0	Locked	Not Synced	0	1	Locked	Not Synced	0	2	Locked	Not Synced	0	3	Locked	Not Synced	0	4	Locked	Not Synced	0	5	Locked	Not Synced	0	6	Locked	Not Synced	0	7	Locked	Not Synced	0	8	Locked	Not Synced	0	9	Locked	Not Synced	0
Channel	PLL Lock Status	Pattern Sync Status	Errors																																										
0	Locked	Not Synced	0																																										
1	Locked	Not Synced	0																																										
2	Locked	Not Synced	0																																										
3	Locked	Not Synced	0																																										
4	Locked	Not Synced	0																																										
5	Locked	Not Synced	0																																										
6	Locked	Not Synced	0																																										
7	Locked	Not Synced	0																																										
8	Locked	Not Synced	0																																										
9	Locked	Not Synced	0																																										
<p>Port</p>	<p>Allows you to specify which interface to test. The following port tests are available:</p> <p>XCVR</p> <p>CMOS</p>																																												

Control	Description
PMA Setting	<p>Allows you to make changes to the PMA parameters that affect the active transceiver interface. The following settings are available for analysis:</p> <p>Serial Loopback—Routes signals between the transmitter and the receiver.</p> <p>VOD—Specifies the voltage output differential of the transmitter buffer.</p> <p>Pre-emphasis tap</p> <ul style="list-style-type: none"> • 1st pre—Specifies the amount of pre-emphasis on the pre-tap of the transmitter buffer. • 2nd pre—Specifies the amount of pre-emphasis on the second pre-tap of the transmitter buffer. • 1st post—Specifies the amount of pre-emphasis on the first post tap of the transmitter buffer. • 2nd post—Specifies the amount of pre-emphasis on the second post tap of the transmitter buffer. <p>Equalizer—Specifies the setting for the receiver equalizer.</p> <p>DC gain—Specifies the DC portion of the receiver equalizer.</p>
Data Type	<p>Specifies the type of data contained in the transactions. The following data types are available for analysis:</p> <ul style="list-style-type: none"> • PRBS 7—Selects pseudo-random 7-bit sequences. • PRBS 15—Selects pseudo-random 15-bit sequences. • PRBS 23—Selects pseudo-random 23-bit sequences. • PRBS 31—Selects pseudo-random 31-bit sequences. • HF—Selects highest frequency divide-by-2 data pattern 10101010. • LF—Selects lowest frequency divide-by-33 data pattern.
Error Control	<p>Displays data errors detected during analysis and allows you to insert errors:</p> <ul style="list-style-type: none"> • Detected errors—Displays the number of data errors detected in the hardware. • Inserted errors—Displays the number of errors inserted into the transmit data stream. • Insert Error—Inserts a one-word error into the transmit data stream each time you click the button. Insert Error is only enabled during transaction performance analysis. • Clear—Resets the Detected errors and Inserted errors counters to zeroes.

Control	Description
Run Control	<p>Start—Initiates the selected ports transaction performance analysis.</p> <p>Note: Always click Clear before Start.</p> <p>Stop—Terminates transaction performance analysis.</p> <p>TX and RX performance bars—Show the percentage of maximum theoretical data rate that the requested transactions are able to achieve.</p>

The DDR3 Tab

This tab allows you to read and write DDR3 memory on your board.

Figure 4-10: The DDR3 Tab

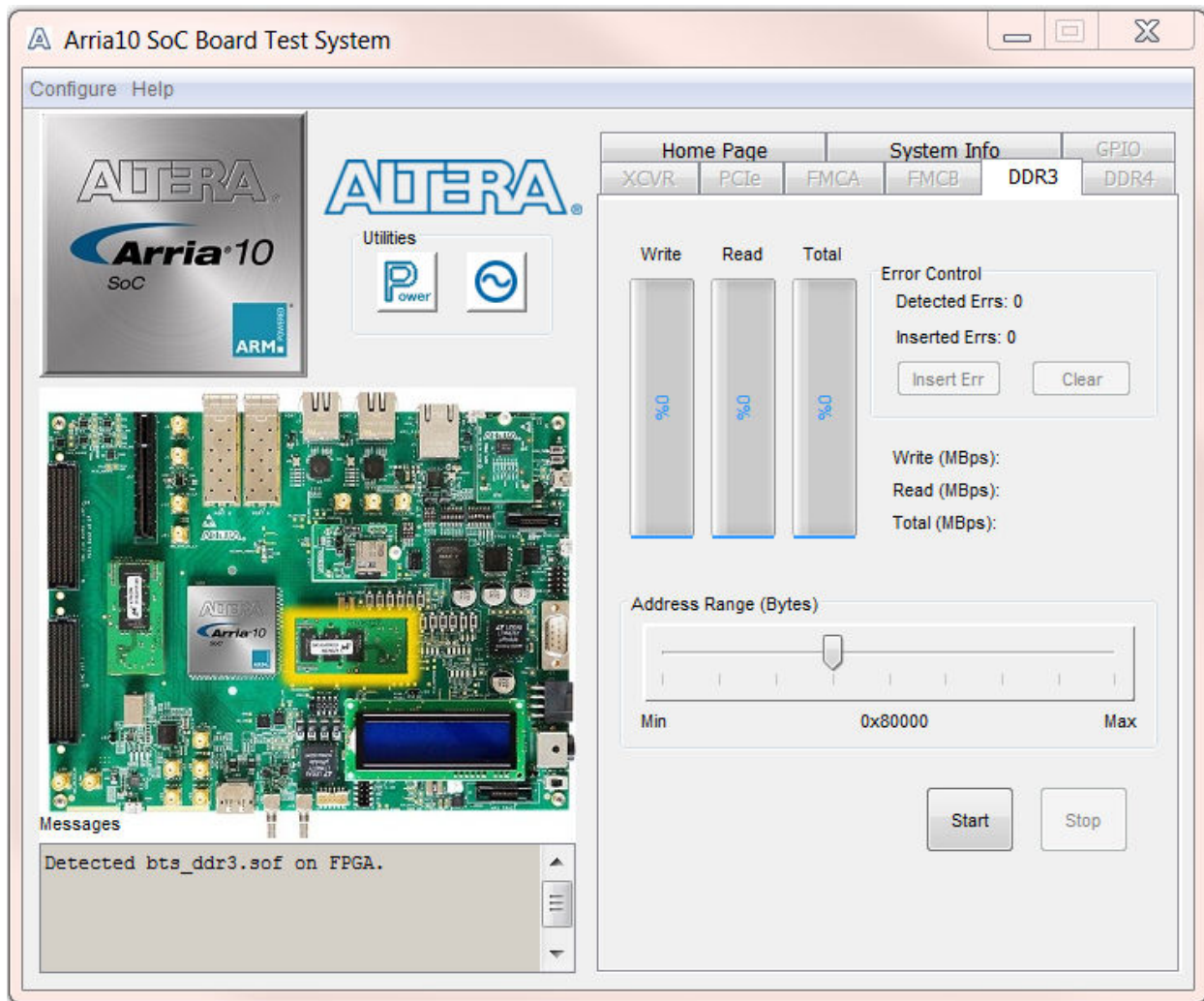

Control	Description
Performance Indicators	<p>These controls display current transaction performance analysis information collected since you last clicked Start:</p> <ul style="list-style-type: none"> • Write, Read, and Total performance bars—Show the percentage of maximum theoretical data rate that the requested transactions are able to achieve. • Write (MBps), Read (MBps), and Total (MBps)—Show the number of bytes of data analyzed per second. • Data bus: 72 bits (8 bits ECC) wide and the frequency is 1066 MHz double data rate. 2133 Megabits per second (Mbps) per pin. Equating to a theoretical maximum bandwidth of 136512 Mbps or 17064 MBps.
Error Control	<p>This control displays data errors detected during analysis and allows you to insert errors:</p> <ul style="list-style-type: none"> • Detected errors—Displays the number of data errors detected in the hardware. • Inserted errors—Displays the number of errors inserted into the transaction stream. • Insert Error—Inserts a one-word error into the transaction stream each time you click the button. Insert Error is only enabled during transaction performance analysis. • Clear—Resets the Detected errors and Inserted errors counters to zeroes.
Number of Addresses to Write and Read	<p>Determines the number of addresses to use in each iteration of reads and writes.</p>

The DDR4 Tab

This tab allows you to read and write DDR4 memory on your board.

Figure 4-11: The DDR4 Tab

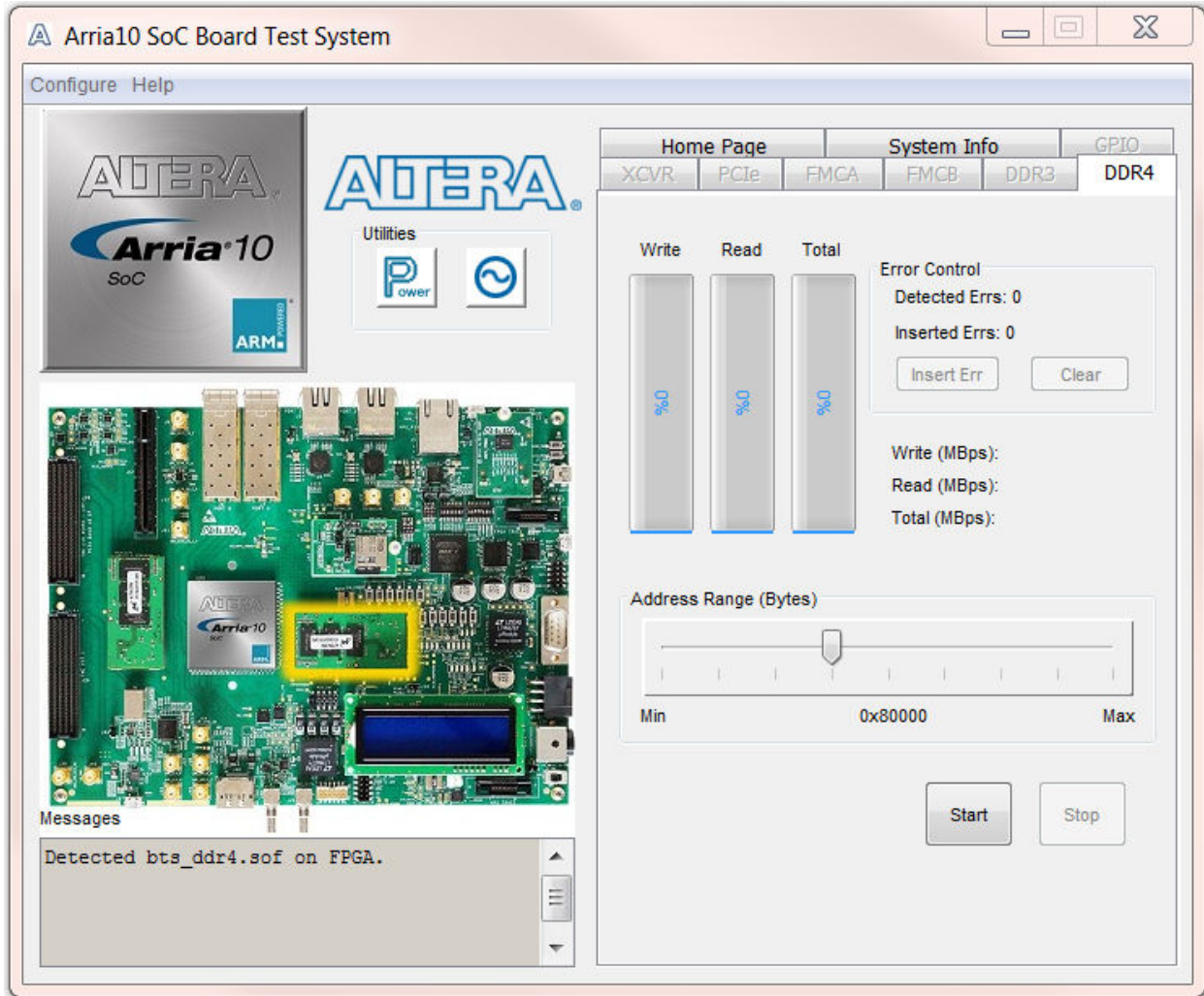

Control	Description
Start	Initiates DDR4 memory transaction performance analysis.
Stop	Terminates transaction performance analysis.

Control	Description
Performance Indicators	<p>These controls display current transaction performance analysis information collected since you last clicked Start:</p> <ul style="list-style-type: none"> • Write, Read, and Total performance bars—Show the percentage of maximum theoretical data rate that the requested transactions are able to achieve. • Write (MBps), Read (MBps), and Total (MBps)—Show the number of bytes of data analyzed per second. • Data bus: 72 bits (8 bits ECC) wide and the frequency is 1066 MHz double data rate. 2133 Megabits per second (Mbps) per pin. Equating to a theoretical maximum bandwidth of 136512 Mbps or 17064 MBps.
Error Control	<p>This control displays data errors detected during analysis and allows you to insert errors:</p> <ul style="list-style-type: none"> • Detected errors—Displays the number of data errors detected in the hardware. • Inserted errors—Displays the number of errors inserted into the transaction stream. • Insert Error—Inserts a one-word error into the transaction stream each time you click the button. Insert Error is only enabled during transaction performance analysis. • Clear—Resets the Detected errors and Inserted errors counters to zeroes.
Number of Addresses to Write and Read	<p>Determines the number of addresses to use in each iteration of reads and writes.</p>

The Power Monitor

The Power Monitor measures and reports current power information and communicates with the MAX V device on the board through the JTAG bus. A power monitor circuit attached to the MAX V device allows you to measure the power that the FPGA is consuming.

To start the application, click the Power Monitor icon in the Board Test System application. You can also run the Power Monitor as a stand-alone application. The **PowerMonitor.exe** resides in the **<Package Root Dir>\examples\board_test_system** directory.

Note: You cannot run the stand-alone power application and the BTS application at the same time. Also, you cannot run power and clock interface at the same time.

Figure 4-12: Power Monitor Interface

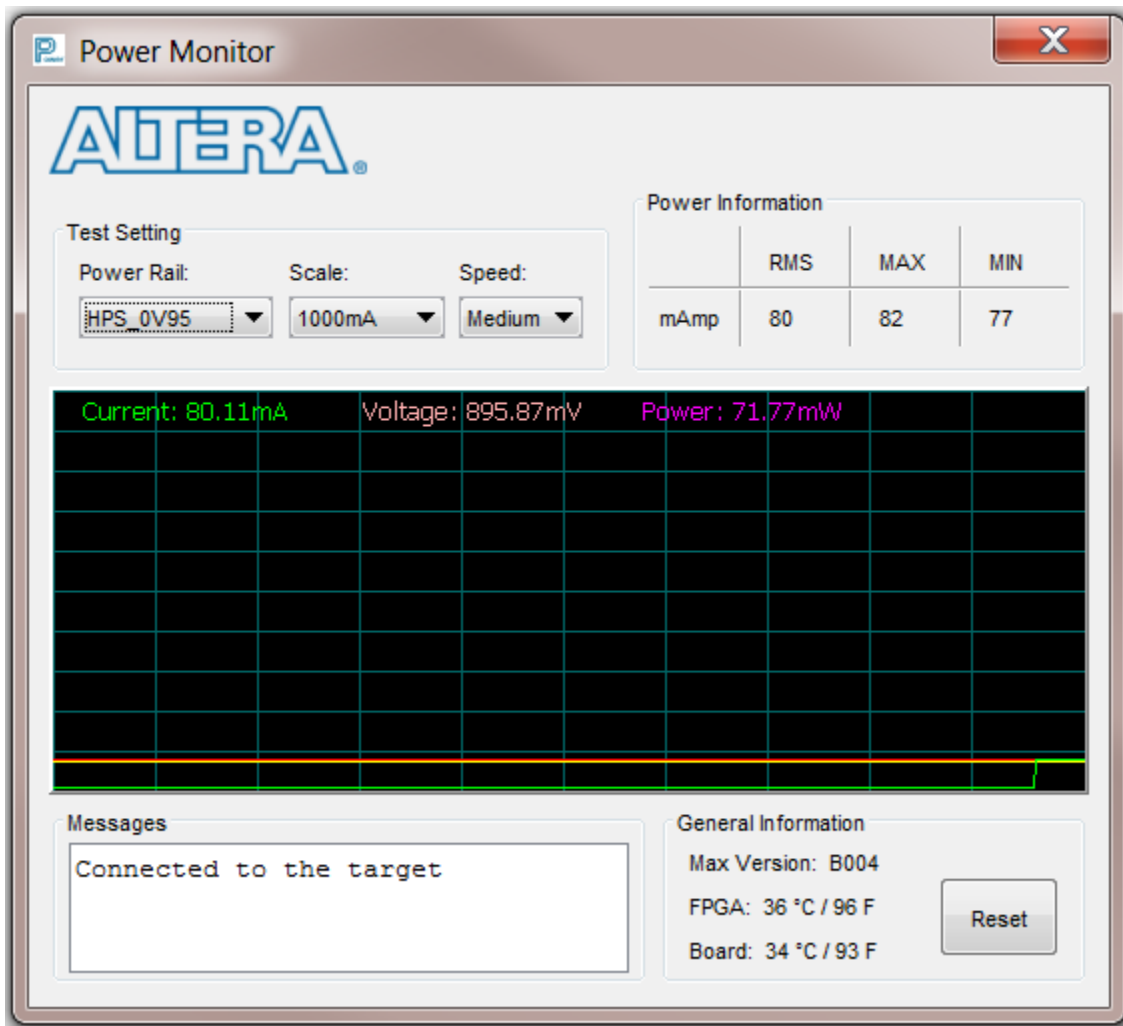

Control	Description
Test Settings	<p>Displays the following controls:</p> <p>Power Rail—Indicates the currently-selected power rail. After selecting the desired rail, click Reset to refresh the screen with updated board readings.</p> <p>Scale—Specifies the amount to scale the power graph. Select a smaller number to zoom in to see finer detail. Select a larger number to zoom out to see the entire range of recorded values.</p> <p>Speed—Specifies how often to refresh the graph.</p>
Power Information	Displays root-mean-square (RMS) current, maximum, and minimum numerical power readings in mA.
Graph	Displays the mA power consumption of your board over time. The green line indicates the current value. The red line indicates the maximum value read since the last reset. The yellow line indicates the minimum value read since the last reset.
General Information	Displays MAX V version and current temperature of the FPGA and board.
Reset	Clears the graph, resets the minimum and maximum values, and restarts the Power Monitor.

The Clock Control

The Clock Control application sets the three programmable oscillators to any frequency between 10 MHz and 810 MHz. The frequencies support eight digits of precision to the right of the decimal point.

The Clock Control communicates with the MAX V device on the board through the JTAG bus. The programmable oscillators are connected to the MAX V device through a 2-wire serial bus.

Figure 4-13: Clock Controller Window

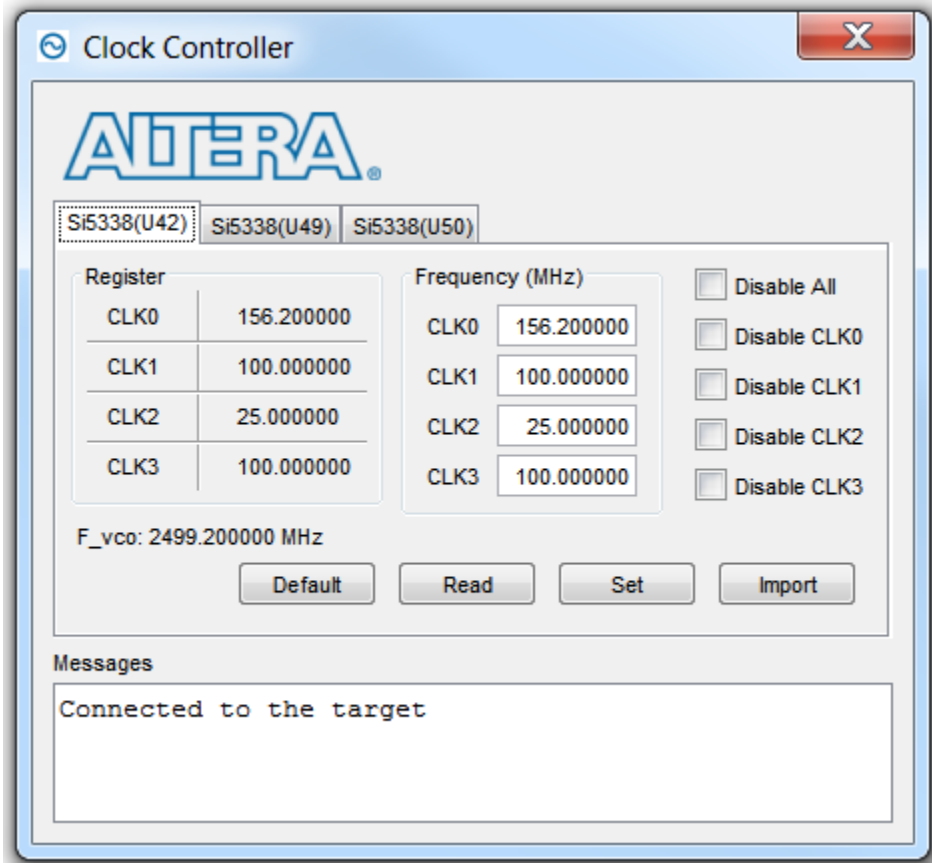

Control	Description
Serial Port Registers	Shows the current values for selected Si5338 registers for frequency configuration.
Target frequency (MHZ)	Allows you to specify the frequency of the clock. Legal values are between 10 and 810 MHz with eight digits of precision to the right of the decimal point. For example, 421.31259873 is possible within 100 parts per million (ppm). The Target frequency control works in conjunction with the Set New Freq control.
fXTAL	Shows the calculated internal fixed-frequency crystal, based on the serial port register values.
Default	Sets the frequency for the oscillator associated with the active tab back to its default value. The default is restored by power cycling the board.

Control	Description
Set New Freq	Sets the programmable oscillator frequency for the selected clock to the value in the Target frequency control for the programmable oscillators. Frequency changes might take several milliseconds to take effect. You might see glitches on the clock during this time. Altera recommends resetting the FPGA logic after changing frequencies.

Each Si5338 tab for U26 and U14 display the same GUI controls for each clock generators. Each tab allows for separate control. The Si5338 is capable of synthesizing four independent user-programmable clock frequencies up to 350 MHz and select frequencies up to 710 MHz.

Control	Description
F_vco	Displays the generating signal value of the voltage-controlled oscillator.
Registers	Display the current frequencies for each oscillator.
Frequency (MHz)	Allows you to specify the frequency of the clock.
Disable all	Disable all oscillators at once.
Read	Reads the current frequency setting for the oscillator associated with the active tab.
Default	Sets the frequency for the oscillator associated with the active tab back to its default value. The default is restored by power cycling the board.
Set New Freq	Sets the programmable oscillator frequency for the selected clock to the value in the CLK0 to CLK3 controls for each Si5338. Frequency changes might take several milliseconds to take effect. You might see glitches on the clock during this time. Altera recommends resetting the FPGA logic after changing frequencies.
Import Reg Map	Import register map file generated from Silicon Laboratories ClockBuilder Desktop.

2016.03.01

UG-20004



Subscribe



Send Feedback

This chapter introduces the major components on the Arria 10 SoC development board. The board overview figure illustrates the component locations and the board components table provides a brief description of all component features of the board.

A complete set of schematics, a physical layout database, and fabrication files for the development board reside in the Arria 10 SoC development kit board design files directory.

Board Overview

This section provides an overview of the Arria 10 SoC development board, including an annotated board image and component descriptions. The figure below shows an overview of the board features.

© 2016 Altera Corporation. All rights reserved. ALTERA, ARRIA, CYCLONE, ENPIRION, MAX, MEGACORE, NIOS, QUARTUS and STRATIX words and logos are trademarks of Altera Corporation and registered in the U.S. Patent and Trademark Office and in other countries. All other words and logos identified as trademarks or service marks are the property of their respective holders as described at www.altera.com/common/legal.html. Altera warrants performance of its semiconductor products to current specifications in accordance with Altera's standard warranty, but reserves the right to make changes to any products and services at any time without notice. Altera assumes no responsibility or liability arising out of the application or use of any information, product, or service described herein except as expressly agreed to in writing by Altera. Altera customers are advised to obtain the latest version of device specifications before relying on any published information and before placing orders for products or services.

ISO
9001:2008
Registered

Figure 5-1: Overview of the Arria 10 SoC Development Board

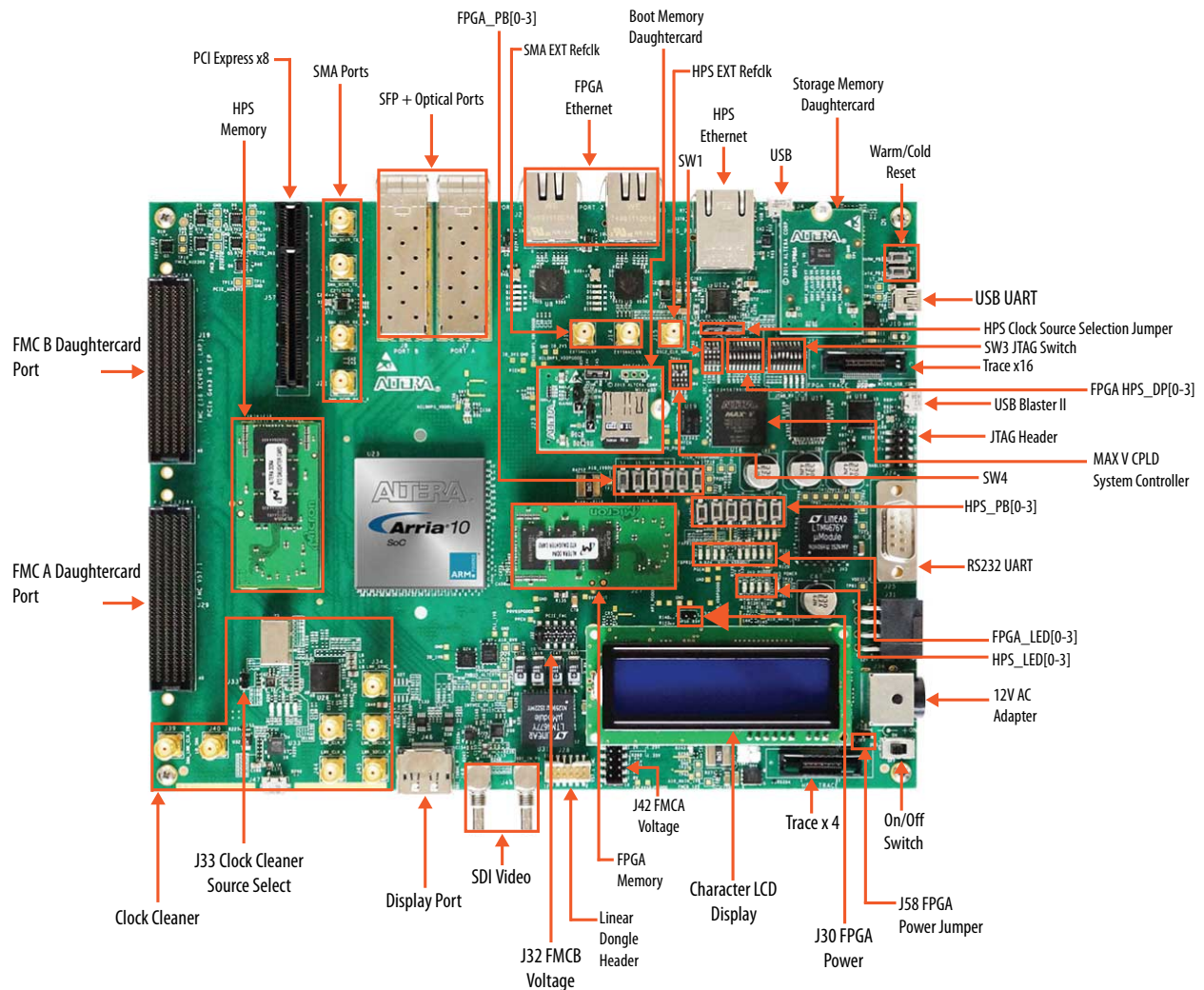

Table 5-1: Board Components

Board Reference	Type	Description
Featured Devices		
U23	FPGA	Arria 10 SoC, 10AS066N3F40E2SGE2, 1517-pin FBGA
U16	CPLD	MAX V CPLD System Controller, 5M2210ZF256, 256-pin FBGA
U21	CPLD	IO_MUX_CPLD, 5M2210F256, 256-pin FBGA
Configuration, Status, and Setup Elements		
J24	JTAG chain header	Provides access to the JTAG chain and disables the on-board USB-Blaster II when using an external USB-Blaster cable.
SW3	JTAG chain control DIP switch	Remove or include devices in the active JTAG chain.

Board Reference	Type	Description
SW4	MSEL DIP Switch	Controls the configuration scheme on the board. MSEL pin 0, 1 and 2 connect to the DIP switch.
J22	Mini-USB header	USB interface for FPGA programming and debugging through the on-board USB-Blaster II JTAG via a type-B USB cable.
SW1	Function Dip switch	Selects I ² C Master, Controls PCIE slot power, and selects FGPA image source.
S8	Program select push button	Toggles the program select LEDs, which selects the program image that loads from flash memory to the FPGA.
S7	Configure push button	Load image from flash memory to the FPGA based on the settings of the program select LEDs.
D18	Configuration done LED	Illuminates when the FPGA is configured.
D19	Load LED	Illuminates when the MAX V CPLD 5M2210 System Controller is actively configuring the FPGA.
D17	Error LED	Illuminates when the FPGA configuration from flash memory fails.
D42	Power LED	Illuminates when 3.3-V power is present.
D13, D14	JTAG TX/RX LEDs	Indicates the transmit or receive activity of the JTAG chain. The TX and RX LEDs flicker if the link is in use and active. The LEDs are either off when not in use or on when in use but idle.
D20-D22	Program select LEDs	Illuminates to show which flash memory image loads to the FPGA when you press the program select push button.
D23, D24	FMC port present LEDs	Illuminates when a daughtercard is plugged into the FMC port.
D11, D12	UART LEDs	Illuminates when UART transmitter and receiver are in use.

Clock Circuitry

U42	Multi-output oscillator	Si5338A quad-output fixed oscillator with 156.25 MHz, 100MHz, 25MHz, and 100MHz outputs.
U54	148.5-MHz Oscillator	Programmable oscillator with a default frequency of 148.5 MHz. The frequency is programmable using the clock control GUI running on the MAX V CPLD 5M2210 System Controller.
U51	50-MHz oscillator	50.000-MHz crystal oscillator for general purpose logic
U11	Multi-output oscillator	Two 100 MHz outputs for PCIe application
J13, J14	Clock input SMA connector	External clock inputs for the transceiver test port
J15	HPS SMA clock	Drives LVCMOS to HPS clock multiplexer.
U50	Multi-output oscillator	Si5338A quad-output fixed oscillator with 125MHz, 270MHz, 100MHz, and 100MHz outputs.

Board Reference	Type	Description
U49	Multi-output oscillator	Si5338A quad-output fixed oscillator with four 133.33MHz outputs.
U26	Multi-output clock cleaner	LMK04828 Clock cleaner
General User Input/Output		
D25-D32	User LEDs	Four user LEDs and four HPS LEDs. Illuminate when driven low.
SW2	User DIP switch	User DIP switch. When the switch is ON, a logic 0 is selected.
S10	FPGA reset push button	Reset the FPGA logic
S9	HPS External Interrupt Push button	HPS external interrupt
S3-S6 S11-S14	General user push buttons	Four user push buttons and four HPS push buttons. Driven low when pressed.
S1, S2	HPS reset push buttons	HPS cold/warm reset push buttons
Memory Connectors		
J26	HPS HILO Memory connector	HPS memory card include DDR3 HILO memory card and DDR4 HILO memory card
J23	Boot Flash Connector	Boot flash card options include QSPI flash card, SD micro flash card and NAND flash card
J27	FPGA HILO Connector	FPGA memory card options include DDR3 HILO memory card , and DDR4 HILO memory card
U19	FPCQ Flash	EPCQ flash for FPGA AS configuration
U45	I ² C EEPROM	32-Kb I ² C serial EEPROM
Communication Ports		
J57	PCI Express socket	GEN3 x8 Socket
J29, J19	FMC port	J29 is a V57.1 compatible FMC connector. J19 is a FMC connector defined by Altera 16 transceivers specification
J7, J8	SFP+ port	Two SFP+ ports
U12, J5	Gigabit Ethernet port	RJ-45 connectors that provide HPS 10/100/1000 Ethernet connections via a Micrel KSZ9031RN PHY.
U8, U9, J2, J3	Dual Gigabit Ethernet port	Provide two SGMII Gigabit Ethernet ports through FPGA transceivers
J10, U13	USB-UART Port	USB connector with USB-to-UART bridge for serial UART interface.
J25	DB9 UART port,	DB9 RS-232 UART Port

Board Reference	Type	Description
J4, U22	USB OTG port	USB 2.0 On-The-Go (OTG) interface.
U5	Real-time clock	DS1339 device with built-in power sense circuit that detects power failures and automatically switches to backup battery supply, maintaining time keeping even when the board is not powered.
J43	HPS Trace connector	4-bit Trace for HPS debug
J20	FPGA Trace	FPGA 16-bit Trace
Video and Display Ports		
J35	Character LCD	Connector that interfaces to the included 16 character × 2 line LCD module along with two standoffs.
J36	Display port connector	Display port interface
J48,J49, U29,U30	SDI Video port	HDBNC 75-Ohm SDI video interface
Power Supply		
J36	DC input jack	Accepts 12-V DC power supply
SW5	Power switch	Switch to power on or off the board when power is supplied from the DC input jack.

Featured Device: Arria 10 SoC

The Arria 10 SoC development board features an Arria 10 SoC 10AS066N3F40E2SGE2 device (U23) that includes a hard processor system (HPS) with integrated ARM[®] Cortex[™] - A9 MPCore processor.

Table 5-2: Arria 10 SoC Features

Resources	10AS066N2F40
LE (K)	660
ALM	250, 540
Register	1,002,160
Memory (Kb)	42,660
18-bit x 18-bit Multiplier	3,356
Transceivers	48

MAX V CPLD 5M2210 System Controller

The board utilizes the 5M2210ZF256 System Controller, an Altera MAX V CPLD, for the following purposes:

- Power sequencer
- System reset controller
- PCIe, FMC slot power sequencer
- FPGA PS configuration controller
- I²C Master controller
- UART Level shifter
- HPS SPI I/O expander
- HPS Shared I/O

Table 5-3: MAX V CPLD System Controller Device Pin Out

I/O Bank	Board Reference	Pin Name	Pin Type	I/O Standard	Description
3	E14	P0V9Pgood	Schmitt trigger input	3.3 V	Power good signal of 0.9 V power rail (Active high)
3	C14	HPS_Pgood	Schmitt trigger input	3.3 V	HPS core voltage power good signal
3	C15	PN0V95pgood	Schmitt trigger input	3.3 V	0.95 V Power supply power good signal (Active high)
3	E13	1V0_Pgood	Schmitt trigger input	3.3 V	1V0 Power supply power good signal (Active high)
3	E12	1V8_Pgood	Schmitt trigger input	3.3 V	1V8 Power supply power good signal (Active high)
3	D15	2V5_Pgood	Schmitt trigger input	3.3 V	2V5 Power supply power good signal (Active high)
3	F14	3V3_Pgood	Schmitt trigger input	3.3 V	3V3 Power supply power good signal (Active high)
3	D16	PGM_LED2	OC	3.3 V	FPGA status LED.
3	F13	5V0_Pgood	Schmitt trigger input	3.3 V	5V0 Power supply power good signal (Active high)
3	E15	HILOHPS_VDDPGood	Schmitt trigger input	3.3 V	HPS_HILO Power supply power good signal
3	E16	HILO_VDDPGood	Schmitt trigger input	3.3 V	HILO VDD power supply power good signal
3	F15	HILO_VDDQPGood	Schmitt trigger input	3.3 V	HILO VDDQ power supply power good signal
3	G14	FMCAVADJPGood	Schmitt trigger input	3.3 V	FMC VADJ Power supply power good signal

I/O Bank	Board Reference	Pin Name	Pin Type	I/O Standard	Description
3	F16	FMCBVADJPGood	Schmitt trigger input	3.3 V	FMC VADJ Power supply power good signal
3	G13	10V_Fail_n	Schmitt trigger input	3.3 V	A10_12V input below 10.11 V (Active low)
3	G15	10V_good	Schmitt trigger input	3.3 V	A10_12V input above 10.62 V (Active low)
3	G12	LTFAUL0	Input/Output	3.3 V	LT2977 Fault signal
3	G16	LTPWRGD	Input/Output	3.3 V	LT2977 Power good input
3	H14	FAC2MPgood	Output	3.3 V	30 ms delay after FMCA_EN and FMCA_AUXEN is enabled.
3	H15	FBC2MPgood	Output	3.3 V	30 ms delay after FMCB_EN and FMCB_AUXEN is enabled.
3	H13	FAM2CPgood	Schmitt trigger input	3.3 V	This flag indicates the power from FMC DC card is good when MAX V I/O CPLD BANK3 power uses FMC POWER.
3	H16	TSENSE_ALERTn	Schmitt trigger input	3.3 V	SMBUS Alert Bit when I ² C hangs
3	J13	OVERTEMPn	Schmitt trigger input	3.3 V	Temperature is above threshold
3	J16	FAN_EN	Output	3.3 V	FAN Enable (Active high)
3	J12	MAXV_USB_CLK	Clock input	3.3 V	Clock input from USB-blaster
3	H12	NC	-	-	-
3	J14	NC	-	-	-
3	J15	A10_EN	Output	3.3 V	Arria 10 12 V input enable (Active high)
3	K16	A10_0V9_EN	Output	3.3 V	0.9 V Power supply enable (Active high)
3	K13	A10_0V95_EN	Output	3.3 V	0.95 V Power supply enable (Active high)
3	K15	A10_1V0_EN	Output	3.3 V	1.0 V Power supply enable (Active high)
3	K14	A10_1V8_EN	Output	3.3 V	1.8 V Power supply enable (Active high)

I/O Bank	Board Reference	Pin Name	Pin Type	I/O Standard	Description
3	L16	IO_EN	Output	3.3 V	Arria 10 I/O power enable (Active high)
3	L11	PCIE_Auxen	Output	3.3 V	PCIE Aux power enable (Active high)
3	L15	PCIE_EN	Output	3.3 V	PCIE 3V3 enable (Active high)
3	L12	FMCA_AUXEN	Output	3.3 V	FMCA Aux power enable (Active high)
3	M16	FMCA_EN	Output	3.3 V	FMCA3V3 enable (Active high)
3	L13	FMCB_AUXEN	Output	3.3 V	FMCB Aux Power enable (Active high)
3	M15	FMCB_EN	Output	3.3 V	FMCB3V3 enable (Active high)
3	L14	Pmbus_Alertn	Schmitt trigger input	3.3 V	Pmbus Alert Bit input when I ² C hangs.
3	N16	IO3V3_Discharge	Output	3.3 V	6A discharge load for IO3V3 (Active high)
3	M13	PLL1V8_discharge	Output	3.3 V	3A discharge load for IO3V3 (Active high)
3	N15	NC			
3	N14	LTCNTRL0	Output	3.3 V	LT2977 Control 0
3	P15	LTCNTRL1	Output	3.3 V	LT2977 Control 1
3	P14	LTWDI_RESETN	Output	3.3 V	LT2977 reset
3	D13	FAPRSNT_n	Schmitt trigger input	3.3 V	Detects signal of FMCA DC card
3	D14	FBPRSNT_N	Schmitt trigger input	3.3 V	Detects signal of FMCB DC card
3	F11	USB_Vflagn	Schmitt trigger input	3.3 V	Overcurrent flag of EXT USB power
3	F12	NC	-		-
3	K12	NC	-		-
3	M14	NC	-		-
3	N13	NC	-		-
4	R1	A10_2L_SDA	Input/OC	3.3 V	I ² C data line.
4	P4	A10_2L_SCL	OC	3.3 V	I ² C clock line.

I/O Bank	Board Reference	Pin Name	Pin Type	I/O Standard	Description
4	T2	A10I2CEN	Output	3.3 V	Enable Arria 10 HPS I ² C. (Active high)
4	P5	A10PMBUSEN	Output	3.3 V	Enable Arria 10 FPGA I ² C. (Active high)
4	R3	A10_PMBUSDIS_N	Output	3.3 V	Disables Arria 10 FPGA PMBus access. (Active low)
4	N5	UARTA_RX	Input	3.3 V	HPS UART RX input from USB-UART.
4	P6	UARTA_TX	Output	3.3 V	HPS UART TX output to USB-UART.
4	N6	PCIE_PRSENT2n	Input	3.3 V	Detects signal from PCIe DC card.
4	R5	SFPA_LOS	Input	3.3 V	SFP+ A socket loss signal. (Active low)
4	M6	SFPA_TXFAULT	Input	3.3 V	SFP+ A socket TX fault signal. (Active low)
4	T5	SFPGA_TXDISABLE	Output	3.3 V	SFP+ A socket TX disable signal. (Active low)
4	P7	SFPA_RATESEL0	Output	3.3 V	SFP+ A RX signaling rate selection, 0<4.25 GBd, 1 > 4.25 GBd
4	R6	SFPA_RATESEL1	Output	3.3 V	SFP+ A TX signaling rate selection, 0<4.25 GBd, 1 > 4.25 GBd
4	N7	SFPB_TXDISABLE	Output	3.3 V	SFP+ B socket TX disable signal. Active low
4	M7	SFPB_RATESEL0	Output	3.3 V	SFP+ B RX signaling rate selection, 0<4.25 GBd, 1 > 4.25 GBd
4	R7	SFPB_RATESEL1	Output	3.3 V	SFP+ B TX signaling rate selection, 0<4.25 GBd, 1 > 4.25 GBd
4	P8	SFPB_LOS	Input	3.3 V	SFP+ A socket loss signal (Active low)
4	T7	SFPB_TXFAULT	Input	3.3 V	SFP+ A socket tx fault signal (Active low)
4	N8	SFPA_MOD0_PRSENTn	Input	3.3 V	Detect signal of SFP+ module in slot A (Active low)

I/O Bank	Board Reference	Pin Name	Pin Type	I/O Standard	Description
4	R8	SFPB_MOD0_PRSENTn	Input	3.3 V	Detect signal of SFP+ module in Slot B. (Active low)
4	T8	NC	-	3.3 V	-
4	T9	NC	-	3.3 V	-
4	R9	Eneta_HPS_Intn	Input	3.3 V	Interrupt input from Ethernet port 3
4	M9	Logic_resetn	Input	3.3 V	FPGA_logic reset input
4	M8	EXT_intn	Input	3.3 V	HPS External interrupt
4	M10	UART1_RX	Input	3.3 V	DB9 RS232 UART RX
4	R10	UART1_TX	Output	3.3 V	DB9 RS232 UART TX
4	N10	NC	Output	3.3 V	-
4	T11	LMK_reset	Output	3.3 V	LMK Clock cleaner reset (Active high)
4	P10	NC	-	3.3 V	-
4	R11	NC	-	3.3 V	-
4	T12	ENET_HPS_RESETn	Output	3.3 V	Ethernet port 3 reset (Active low)
4	N11	USB_RESET	Output	3.3 V	USB PHY reset (Active high)
4	T13	PCIE_PERSTn	Output	3.3 V	This signal needs to be held low if PCIE_auxEn and PCIE_EN are not active. 15 ms delay to set this high after PCIE_EN is active. PCIe RC slot reset, active low.
4	R13	RESET_HPS_UARTA_N	Output	3.3 V	UART_RESET (Active low)
4	R12	MAX2toMAXV0	Input/Output	3.3 V	Interbus between MAX II and MAX V
4	P11	MAX2toMAXV1	Input/Output	3.3 V	Interbus between MAX II and MAX V
4	N12	MAX2toMAXV2	Input/Output	3.3 V	Interbus between MAX II and MAX V
4	R14	MAX2toMAXV3	Input/Output	3.3 V	Interbus between MAX II and MAX V
4	P12	MAX2toMAXV4	Input/Output	3.3 V	Interbus between MAX II and MAX V

I/O Bank	Board Reference	Pin Name	Pin Type	I/O Standard	Description
4	T15	MAX2toMAXV5	Input/Output	3.3 V	Interbus between MAX II and MAX V
4	R16	MAX2toMAXV6	Input/Output	3.3 V	Interbus between MAX II and MAX V
4	P13	MAX2toMAXV7	Input/Output	3.3 V	Interbus between MAX II and MAX V
4	M11	MAX2toMAXV8	Input/Output	3.3 V	Interbus between MAX II and MAX V
4	M12	MAX2toMAXV9	Input/Output	3.3 V	Interbus between MAX II and MAX V
4	N9	MAX2toMAXV10	Input/Output	3.3 V	Interbus between MAX II and MAX V
4	R4	MAX2toMAXV11	Input/Output	3.3 V	Interbus between MAX II and MAX V
4	T10	MAX2toMAXV12	Input/Output	3.3 V	Interbus between MAX II and MAX V
4	T4	MAX2toMAXV13	Input/Output	3.3 V	Interbus between MAX II and MAX V
2	D4	USER_LED_FPGA0	OC	2.5 V	USER FPGA LED 0 output
2	B1	USER_LED_FPGA1	OC	2.5 V	USER FPGA LED 1 output
2	C5	USER_LED_FPGA2	OC	2.5 V	USER FPGA LED 2 output
2	C4	USER_LED_FPGA3	OC	2.5 V	USER FPGA LED 3 output
2	B4	USER_LED_HPS0	OC	2.5 V	HPS LED 0 output
2	D6	USER_LED_HPS1	OC	2.5 V	HPS LED 1 output
2	E6	USER_LED_HPS2	OC	2.5 V	HPS LED 2 output
2	B5	USER_LED_HPS3	OC	2.5 V	HPS LED 3 output
2	A5	MAX_ERROR	OC	2.5 V	Board abnormal indicator
2	D7	MAX_LOAD	OC	2.5 V	FPGA status LED
2	B6	MAX_CONF_DONE	OC	2.5 V	FPGA status LED
2	E7	File_Presentn	Input	2.5 V	File flash present flag
2	C8	FACTORY_LOAD	OC	2.5 V	FPGA status LED
2	B7	PGM_LED0	OC	2.5 V	FPGA status LED
2	D8	PGM_SEL	Input	2.5 V	FPGA external trigger

I/O Bank	Board Reference	Pin Name	Pin Type	I/O Standard	Description
2	A7	BF_Presentn	Input	2.5 V	Boot Flash present flag
2	B8	USER_DIPSW_HPS0	Input	2.5 V	User DIP HPS 0
2	A8	USER_DIPSW_HPS1	Input	2.5 V	User DIP HPS 1
2	A9	USER_DIPSW_HPS2	Input	2.5 V	User DIP HPS 2
2	E9	USER_DIPSW_HPS3	Input	2.5 V	User DIP HPS 3
2	B9	USER_DIPSW_FPGA0	Input	2.5 V	User DIP FPGA 0
2	D9	USER_DIPSW_FPGA1	Input	2.5 V	User DIP FPGA 1
2	A10	USER_DIPSW_FPGA2	Input	2.5 V	User DIP FPGA 2
2	C9	USER_DIPSW_FPGA3	Input	2.5 V	User DIP FPGA 3
2	E10	HPS_WARM_RESET1N	Input	2.5 V	Trace reset from MAX II (Active low)
2	A11	HPS_WAM_RESETn	Input	2.5 V	Warm reset Pushbutton (Active low)
2	B11	HPS_cold_resetn	Input	2.5 V	COLD reset Pushbutton (Active low)
2	A12	DC_Power_CTRL	Input	2.5 V	DC card power on/off switch. 0 turn off DC power 1 turn on DC power
2	E11	I2C_flag	Input	2.5 V	I ² C master selection, '0' MAX V, '1' HPS
2	B12	PGM_CONFIG	Input	2.5 V	FGPA external trigger
2	C11	Security_mode	Input	2.5 V	FPGA mode bit
2	B13	PGM_LED1	OC	2.5 V	FPGA status LED
2	D12	MAXVtoMAXV4	Input/Output	2.5 V	Interbus between MAX Vs
2	B14	MAXVtoMAXV5	Input/Output	2.5 V	Interbus between MAX Vs
2	C13	MAXVtoMAXV6	Input/Output	2.5 V	Interbus between MAX Vs
2	B16	MAXVtoMAXV7	Input/Output	2.5 V	Interbus between MAX Vs
2	A13	MAXVtoMAXV8	Input/Output	2.5 V	Interbus between MAX Vs
2	A15	MAXVtoMAXV9	Input/Output	2.5 V	Interbus between MAX Vs

I/O Bank	Board Reference	Pin Name	Pin Type	I/O Standard	Description
2	A2	USER_PB_HPS0	Input	2.5 V	HPS user push button 0
2	A4	USER_PB_HPS1	Input	2.5 V	HPS user push button 1
2	A6	USER_PB_HPS2	Input	2.5 V	HPS user push button 2
2	B10	USER_PB_HPS3	Input	2.5 V	HPS user push button 3
2	B3	USER_PB_FGPA0	Input	2.5 V	FPGA user push button 0
2	C10	USER_PB_FGPA1	Input	2.5 V	FPGA user push button 1
2	C12	USER_PB_FGPA2	Input	2.5 V	FPGA user push button 2
2	C6	USER_PB_FGPA3	Input	2.5 V	FPGA user push button 3
2	C7	MAXVtoMAXV3	Input/Output	2.5 V	Interbus between MAX Vs
2	D10	MAXVtoMAXV10	Input/Output	2.5 V	Interbus between MAX Vs
2	D11	MAXVtoMAXV11	Input/Output	2.5 V	Interbus between MAX Vs
2	D5	MAXVtoMAXV12	Input/Output	2.5 V	Interbus between MAX Vs
2	E8	MAXVtoMAXV13	Input/Output	2.5 V	Interbus between MAX Vs
1	D3	MSEL0	Input	1.8 V	FPGA program mode selection
1	C2	MSEL1	Input	1.8 V	FPGA program mode selection
1	C3	MSEL2	Input	1.8 V	FPGA program mode selection
1	E3	MFD0	Input/Output	1.8 V	EPCQ data0
1	D2	MFD1	Input/Output	1.8 V	EPCQ data1
1	E4	MFD2	Input/Output	1.8 V	EPCQ data2
1	D1	MFD3	Input/Output	1.8 V	EPCQ data3
1	E5	CLK_50M_MAX	Output	1.8 V	50 MHz clock to FPGA
1	F3	MFCSN	Output	1.8 V	EPCQ chip select.
1	E1	MFCLK	Output	1.8 V	EPCQ chip clock.
1	F4	HPSUARTA_TX	Input	1.8 V	HPS UART TX.
1	F2	HPSUARTA_RX	Output	1.8 V	HPS UART RX.
1	F1	SPIM1_MOSI	Input	1.8 V	SPI data input.
1	F6	SPIM1_SS0_N	Input	1.8 V	SPI chip select 0

I/O Bank	Board Reference	Pin Name	Pin Type	I/O Standard	Description
1	G2	SPIM1_SS1_N	Input	1.8 V	SPI chip select 1
1	G3	SPIM1_MISO	Output	1.8 V	SPI data output.
1	G1	MAXVtoMAXV0	Input/Output	1.8 V	Interbus between MAX Vs
1	G4	MAXVtoMAXV1	Input/Output	1.8 V	Interbus between MAX Vs
1	H2	MAXVtoMAXV2	Input/Output	1.8 V	Interbus between MAX Vs
1	G5	MAX_IO_CLK	Output	1.8 V	50Mhz Clock Output to IO MAXV CPLD
1	H3	A10SH_GPIO0	Input/Output	1.8 V	HPS GPIO 5
1	J1	A10SH_GPIO1	Input/Output	1.8 V	HPS GPIO 13
1	H4	A10SH_GPIO2	Input/Output	1.8 V	HPS GPIO 16
1	J2	A10SH_GPIO3	Input/Output	1.8 V	HPS GPIO 17
1	H5	CLK_50M_MAX	Input	1.8 V	MAX V 50 MHz reference clock
1	J5	SPIM1_CLK	Input	1.8 V	SPIM1_CLK input
1	J4	PS_D0	Output	1.8 V	Passive configure D0
1	K1	Nconfig	Output	1.8 V	Passive configure Nconfig output
1	J3	DCLK	Output	1.8 V	Program Clock
1	K2	CVP_configDone	Input	1.8 V	CVP configure done input during configuration, UART_TX after configuration
1	K5	NSTATUS	Input	1.8 V	Status bit during FPGA configuration
1	L1	conf_done	Input	1.8 V	Configuration done
1	L2	DEV_CLRN	Output	1.8	FPGA reset bit
1	K3	CRCError	Output	1.8 V	CRCError during configuration, UART_RX after configuration
1	M1	Dedicated_tx	Input	1.8 V	Dedicated UART TX input
1	M2	Daticated_RX	Output	1.8 V	Dedicated UART RX Output
1	L4	FPGA_IO5	Input	1.8 V	FPGA_IO5

I/O Bank	Board Reference	Pin Name	Pin Type	I/O Standard	Description
1	L3	FPGA_IO4	Output	1.8 V	FPGA_IO4
1	N1	FPGA_IO3	Output	1.8 V	FPGA_IO3
1	M4	FPGA_IO2	Output	1.8 V	FPGA_IO2
1	N2	FPGA_IO1	Input/Output	1.8 V	FPGA_IO1
1	M3	FPGA_IO0	Input/Output	1.8 V	FPGA_IO0
1	N3	PCIE1V8_PERSTn	Output	1.8 V	15 ms delay PCIE-PHY 0_Reset after PCIE_En is activated if I/O MAX V function is disabled.
1	P2	PCIE1V8_PERST1n	Output	1.8 V	PCIE_PHY1 reset must be connected to the I/O MAX V bit R16 (FBLAP33) via interbus if the I/O MAX V function is disabled.
1	E2	BQSPI_RESETN	Input/Output	1.8 V	Boot flash reset
1	F5	HPS_NPOR	Output	1.8 V	NPOR output of HPS
1	H1	HPS_NRST	Output	1.8 V	NRST output of HPS
1	K4	FILE_RESETN	Output	1.8 V	File flash reset
1	L5	Dedicated_OE	Input	1.8 V	Dedicated UART Enable input
1	P3	M5_JTAG_TCK	Input	1.8 V	JTAG clock
1	L6	M5_JTAG_TDI	Input	1.8 V	JTAG data in
1	M5	M5_JTAG_TDO	Output	1.8 V	JTAG data out
1	N4	M5_JTAG_TMS	Input	1.8 V	JTAG_TMS

FPGA Configuration

This section describes the FPGA, I/O MUX CPLD, and MAX V CPLD 5M2210 System Controller device programming methods supported by the Arria 10 SoC development board.

The Arria 10 SoC development board supports the following configuration methods using JTAG:

- On-board USB-Blaster II is the default method for configuring the FPGA using the Quartus Prime Programmer in JTAG mode with the supplied USB cable.
- External Mictor connector for configuring the HPS using the ARM DS-5 Altera Edition software and DSTREAM or JTAG debug and trace tools such as Lauterbach TRACE32.
- External USB-Blaster for configuring the FPGA when you connect the external USB-Blaster to the JTAG header (J24).

System Controller Configuration

J58 is used to turn off the FPGA power. The following table lists the status of each J58 configuration.

Table 5-4: J58 Jumper Settings

Board Reference	Description
J58	<ul style="list-style-type: none"> • OPEN: Normal application • SHORT: No power to FPGA

Caution: The MAX V system controller controls the power sequence. The wrong configuration file may damage the board.

The following procedure must be followed to program the system controller MAX V:

1. Short J58
2. Set SW3 Bits to:

Table 5-5: SW3 System Configuration Mode for System Controller MAX V Programming

Bit1	Bit2	Bit3	Bit4	Bit5	Bit6	Bit7	Bit8
ON	ON	ON	ON	ON	OFF	OFF	ON

3. Turn on the power; the red LED will be flashing
4. Connect the USB cable to the on-board USB-Blaster II
5. Use “autodetect” in Quartus Prime to detect MAX V
6. Load the MAX V .pof file into Quartus Prime
7. Program the MAX V device
8. Turn off the power and remove J58
9. Set SW3 to normal operation mode

Refer to [#iga1438035477237/table_hx1_jyz_zs](#) for SW3 configuration.

10. Turn on the power; the red LED will always be on

FPGA Programming over On-Board USB-Blaster II

Table 5-6: SW3 Configuration for On-Board USB-Blaster II Mode

Bit1	Bit2	Bit3	Bit4	Bit5	Bit6	Bit7	Bit8
OFF	OFF	ON	ON	ON	OFF	OFF	OFF

This configuration method implements a mini-USB connector (J22), a USB 2.0 PHY device (U18), and an Altera MAX II CPLD EPM1270M256C4N (U17) to allow FPGA configuration using a USB cable. This USB cable connects directly between the USB connector on the board and a USB port on a PC running the Quartus Prime software.

The on-board USB-Blaster II in the MAX II CPLD EPM1270M256C4N normally masters the JTAG chain. The on-board USB-Blaster II shares the pins with the external header and is automatically disabled when you connect an external USB-Blaster to the JTAG chain through the JTAG header (J24). In addition to the JTAG interface, the on-board USB Blaster II has trace capabilities for HPS debug purposes. The trace interface from the HPS routes to the on-board USB-Blaster II connection pins through the FPGA.

Figure 5-2: JTAG Chain

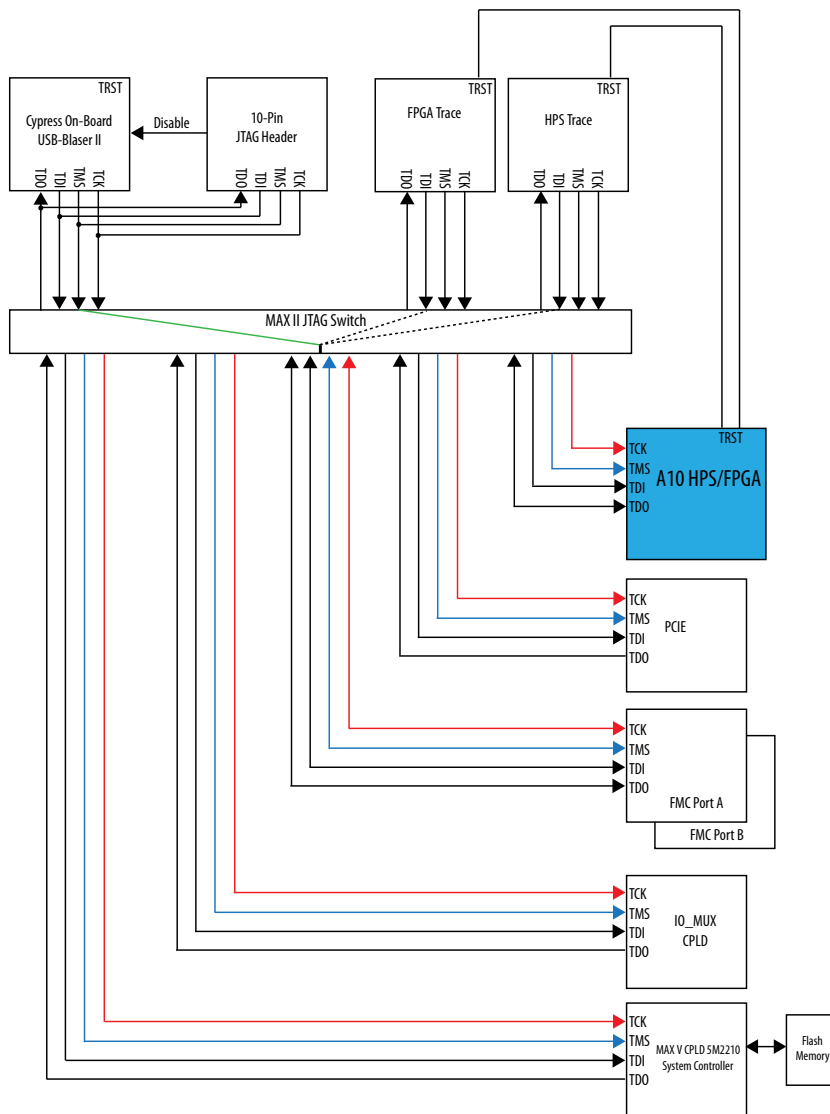

Note: If an external USB-Blaster (I/II) cable is plugged into the EXTERNAL JTAG HEADER, the MAX II automatically uses it as the master despite any DIP switch setting.

The MAX II CPLD (EPM1270M256C4N) is dedicated to the on-board USB-Blaster II functionality only, connecting to the USB 2.0 PHY device on one side and driving JTAG signals out the other side on the GPIO pins. This device's own dedicated JTAG interface is routed to a small surface-mount header only intended for debugging of first article prototypes.

FPGA Programming by HPS

The default method is to use the factory design—Golden Hardware Reference Design (GHRD).

Table 5-7: HPS FPGA Configuration

Configuration	Switch Position
HPS FPGA	SW4.4:OFF(Down)=MSEL2 is 0
	SW4.3:OFF(Down)=MSEL1 is 0
	SW4.2:OFF(Down)=MSEL0 is 0

Table 5-8: AS Configuration

Configuration	Switch Position
Active Serial (AS)	SW4.4:OFF(Down)=MSEL2 is 0
	SW4.3:ON(Up)=MSEL1 is 1
	SW4.2:ON(Up)=MSEL0 is 1

On power-up or by pressing the warm/cold reset push button, the HPS downloads the GHRD design from boot flash to configure the FPGA. The D17 (Error LED) is turned off and D18 (Configuration done LED) is turned on after the FPGA is configured.

By default the FPGA is configured by the HPS.

Refer to the [GSRD User Manual](#) for more information.

FPGA Programming by EPCQ Device

An EPCQ device is used for FPGA configuration in Active Serial (AS) mode on power up. The EPCQ device with non-volatile memory features a simple six-pin interface and a small form factor. The EPCQ supports AS x1 and x4 modes.

FPGA Programming over External USB-Blaster

The JTAG chain header provides another method for configuring the FPGA using an external USB-Blaster device with the Quartus Prime Programmer running on a PC. To prevent contention between the JTAG masters, the on-board USB-Blaster is automatically disabled when you connect an external USB-Blaster to the JTAG chain through the JTAG chain header.

Status Elements

The development board includes status LEDs. This section describes the status elements.

Table 5-9: Board Specific LEDs

Board Reference	Type	Description
D18	Configuration done LED	Illuminates when the FPGA is configured.
D19	Load LED	Illuminates when the MAX V CPLD 5M2210 System Controller is actively configuring the FPGA.
D17	Error LED	Red LED illuminates when the FPGA configuration from flash memory fails.
D42	Power LED	Illuminates when 3.3-V power is present.
D13, D14	JTAG TX/RX LEDs	Indicate the transmit or receive activity of the JTAG chain. The TX and RX LEDs flicker if the link is in use and active. The LEDs are either off when not in use or on when in use but idle.
D20-D22	Program select LEDs	Illuminates to show which flash memory image loads to the FPGA when you press the program select push button.
D23, D24	FMC port present LEDs	Illuminates when a daughtercard is plugged into the FMC port.
D11, D12	UART LEDs	Illuminates when the UART transmitter and receiver are in use.

Setup Elements

The development board includes several different kinds of setup elements. This section describes the following setup elements:

- Board settings DIP switch
- JTAG chain control DIP switch
- FPGA configuration mode DIP switch
- HPS jumpers
- CPU reset push button
- Logic reset push button
- Program configuration push button
- Program select push button

Board Settings DIP Switch

The board settings DIP switches (SW1 and SW4) control various features specific to the board and the MAX V CPLD 5M2210 System Controller logic design. Refer to the "Default Switch and Jumper Settings" section for more information on SW1 and SW4.

Related Information

[Default Switch and Jumper Settings](#) on page 3-2

JTAG Chain Control DIP Switch

The JTAG chain control DIP switch (SW3) either removes or includes devices in the active JTAG chain.

The SW3 switch select controls the JTAG master/slave select. The DIP switch *MSTR* switches control the master select. The other 5 pins are bypass pins for the various available JTAG slaves. The following slaves are available and can be bypassed by moving the corresponding bypass switch to the 'ON' position.

Table 5-10: JTAG Configuration Modes

Switch 3 Bit	Board Label	Function
1	Arria 10	ON- Arria10 JTAG Bypass OFF- Arria10 JTAG Enable
2	I/O MAX V	ON- MAXV JTAG Bypass OFF- MAXV JTAG Enable
3	FMCA	ON- FMCA JTAG Bypass OFF- FMCA JTAG Enable
4	FMCB	ON- FMCB JTAG Bypass OFF- FMCB JTAG Enable
5	PCIe	ON- PCIe JTAG Bypass OFF- PCIe JTAG Enable
6	MSTR[0]	Refer to Table 5-11
7	MSTR[1]	Refer to Table 5-11
8	MSTR[2]	Refer to Table 5-11

The *MSTR* switch settings and their meanings can be seen in the table below.

Table 5-11: Modes for Master Switches

MSTR2	MSTR1	MSTR0	Modes
ON	ON	ON	BOOT
OFF	ON	ON	FMCA JTAG Master
ON	OFF	ON	FMCB JTAG Master
ON	ON	OFF	FTRACE JTAG Master
OFF	OFF	OFF	On-Board USB-Blaster II JTAG Master
ON	OFF	OFF	System Configuration Mode
OFF	ON	OFF	GUI Test Mode
OFF	OFF	ON	Reserved

The bypass switch settings dictate which slaves are in/out of the chain, but see below for the order if all were enabled in the chain.

1. Arria 10
2. IO_MAXV
3. PCIe
4. FMCA
5. FMCB

Reference Clock Source Selection

The HPS jumpers define the bootstrap options for the HPS—boot source, mode, HPS clocks settings, power-on-reset (POR) mode and peripherals selection.

Table 5-12: HPS Jumpers

Board Reference	Schematic Signal Name	Description
J17, J16	OSC2_CLK_SEL [1:0]	Selects the source of OSC2 clock: 00—Select 25 MHz clock source 01—Select external source via SMA connector 10—Select 33 MHz on-board oscillator
J30	HPS voltage selection	Short—HPS core voltage is 0.95V Open—HPS core voltage is 0.9V

CPU Reset Push Button

Table 5-13: CPU Reset Push Buttons

Push Button	Description
S1	HPS_WARM_RESET push button.
S2	HPS_COLD_RESET push button.

The HPS_NRST input is driven by HPS_WARM_RESET. The HPS_NPOR input is driven by HPS_COLD_RESET.

Logic Reset Push Button

The logic reset push button (S10) is an input to the MAX V CPLD 5M2210 System Controller. This push button is the default reset for the CPLD logic and FPGA.

General User Input/Output

All user-defined push buttons, DIP switches and LEDs are connected to the MAX V System Controller. The IO_MUX CPLD maps user-defined signals to FPGA I/Os as defined in the GHRD. The following section describes the mapping table.

Character LCD

The development board includes a single 10-pin 0.1" pitch single-row header that interfaces to a 2 line × 16 character Lumex character LCD using a standard I²C interface connected to the HPS.

For more information such as timing, character maps, interface guidelines, and other related documentation, visit <http://www.newhavendisplay.com>.

Clock Circuitry

This section describes the board's clock inputs and outputs.

On-Board Oscillators

Figure 5-3: FPGA I/O Bank Clock Connection

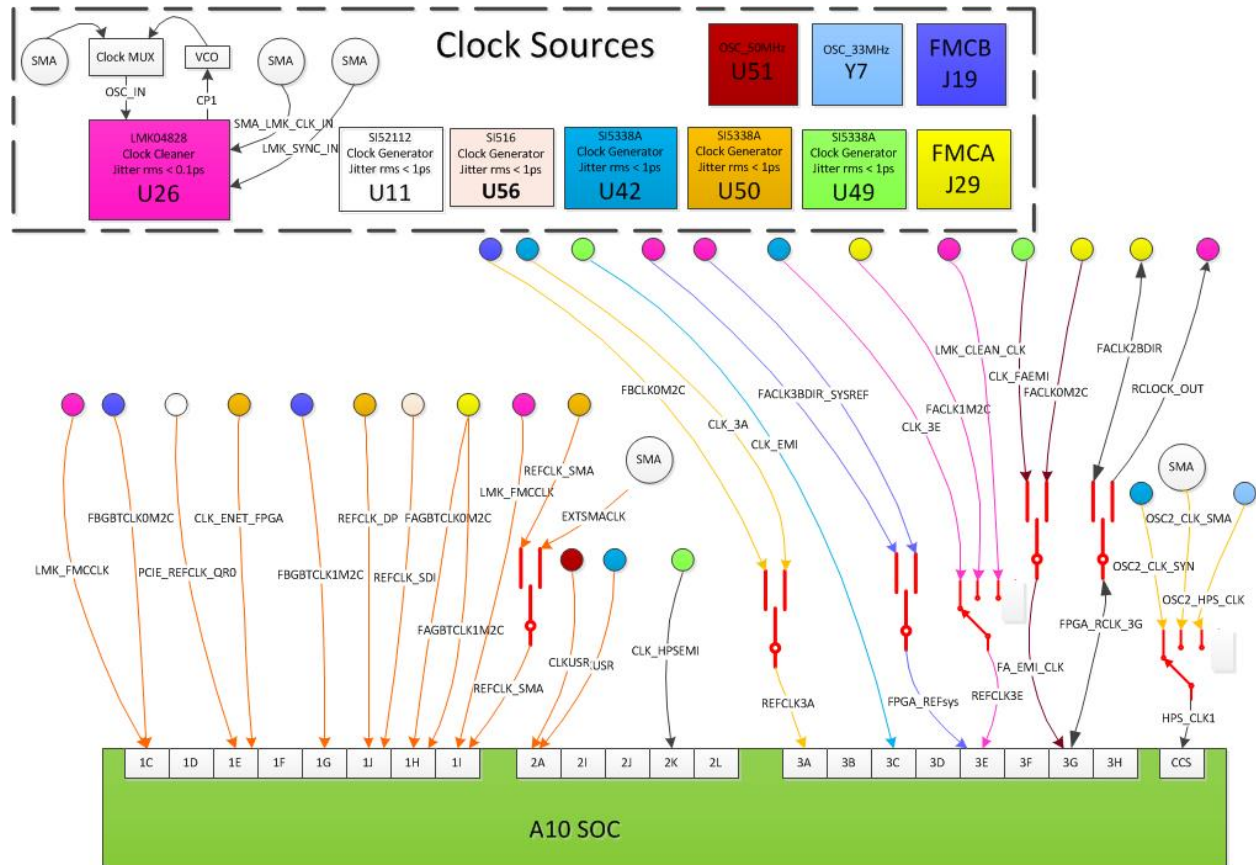

Match the colors in the above figure to match the FPGA I/O banks with its corresponding clock sources.

Components and Interfaces

This section describes the development board's communication ports and interface cards relative to the Arria 10 SoC device. The development board supports the following communication ports:

- PCI Express Gen3 root complex and end point
- 10/100/1000 Ethernet (HPS)
- 10/100/1000 Ethernet (FPGA)
- FMC
- RS-232 UART (HPS)
- Real-Time Clock
- SFP+
- I²C interface

PCI Express

The PCIe RC interface on the development board supports auto-negotiating channel width from x1 to x8 as well as the connection speed of Gen3 at 8 Gbps/lane.

The PCI express end point interface is connected to the FMCB slot. A special PCIE-FMC cable (HDR-181157-01-PCIEC) made by SAMTEC must be plugged into the FMCB slot for the PCIe EP application.

For the PCIe RC application, the `PCIE_REFCLK_P/N` signal is a 100-MHz differential input that is driven to the daughtercard through the PCIe edge connector. This signal connects directly to a Arria 10 SoC `REFCLK` input pin pair using DC coupling. The I/O standard is High-Speed Current Steering Logic (HCSL).

Figure 5-4: PCI Express Reference Clock Levels

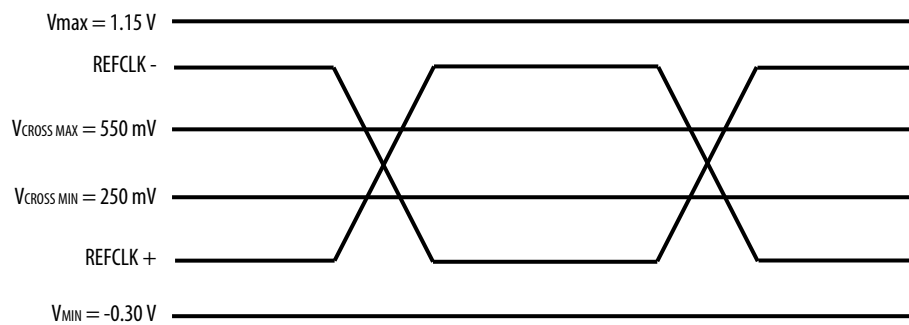

The PCI Express edge connector also has a presence detect feature for the motherboard to determine if a card is installed.

Table 5-14: PCI Express FPGA Pin Assignments

Arria 10 SoC Pin Name	Schematic Signal Name	Direction	Description
Y38	PCIE_TX_N7	Output	PCIe RC Channel 7 Transmitter
Y39	PCIE_TX_P7	Output	PCIe RC Channel 7 Transmitter
Y34	PCIE_RX_N7	Input	PCIe RC Channel 7 Receiver
Y35	PCIE_RX_P7	Input	PCIe RC Channel 7 Receiver
AA36	PCIE_TX_N6	Output	PCIe RC Channel 6 Transmitter
AA37	PCIE_TX_P6	Output	PCIe RC Channel 6 Transmitter
AA32	PCIE_RX_N6	Input	PCIe RC Channel 6 Receiver
AA33	PCIE_RX_P6	Input	PCIe RC Channel 6 Receiver
AB38	PCIE_TX_N5	Output	PCIe RC Channel 5 Transmitter
AB39	PCIE_TX_P5	Output	PCIe RC Channel 5 Transmitter
AB34	PCIE_RX_N5	Input	PCIe RC Channel 5 Receiver
AB35	PCIE_RX_P5	Input	PCIe RC Channel 5 Receiver
AC36	PCIE_TX_N4	Output	PCIe RC Channel 4 Transmitter
AC37	PCIE_TX_P4	Output	PCIe RC Channel 4 Transmitter
AB30	PCIE_RX_N4	Input	PCIe RC Channel 4 Receiver
AB31	PCIE_RX_P4	Input	PCIe RC Channel 4 Receiver
AD38	PCIE_TX_N3	Output	PCIe RC Channel 3 Transmitter
AD39	PCIE_TX_P3	Output	PCIe RC Channel 3 Transmitter
AC32	PCIE_RX_N3	Input	PCIe RC Channel 3 Receiver
AC33	PCIE_RX_P3	Input	PCIe RC Channel 3 Receiver
AE36	PCIE_TX_N2	Output	PCIe RC Channel 2 Transmitter
AE37	PCIE_TX_P2	Output	PCIe RC Channel 2 Transmitter
AD34	PCIE_RX_N2	Input	PCIe RC Channel 2 Receiver
AD35	PCIE_RX_P2	Input	PCIe RC Channel 2 Receiver
AE28	-	Input	Pull down to Ground, no use
AE29	-	Input	Pull down to Ground, no use

10/100/1000 Ethernet (HPS)

The development board supports an RJ-45 10/100/1000 base-T Ethernet using an external Micrel KSZ9031RN PHY and the HPS EMAC function. The PHY-to-MAC interface employs RGMII connection using four data lines at 250 Mbps each for a connection speed of 1 Gbps.

The PHY interfaces to an RJ-45 model with internal magnetics that can be used for driving copper lines with Ethernet traffic.

Figure 5-5: RGMII Interface between HPS (MAC) and PHY



Table 5-15: Ethernet (HPS) Pin Assignments

FPGA Pin Number	Shared I/O Bit	Schematic Signal Name	Description
H18	GPIO0_IO12	ENET_HPS_GTX_CLK	EMAC0 RGMII TX Clock
H19	GPIO0_IO13	ENET_HPS_TX_EN	EMAC0 RGMII enable
F18	GPIO0_IO14	ENET_HPS_RX_CLK	EMAC0 RGMII RX Clock
G17	GPIO0_IO15	ENET_HPS_RX_DV	EMAC0 RGMII RX DV flag
E20	GPIO0_IO16	ENET_HPS_TXD0	EMAC0 RGMII TXD0
F20	GPIO0_IO17	ENET_HPS_TXD1	EMAC0 RGMII TXD1
G20	GPIO0_IO18	ENET_HPS_RXD0	EMAC0 RGMII RXD0
G21	GPIO0_IO19	ENET_HPS_RXD1	EMAC0 RGMII RXD1
F19	GPIO0_IO20	ENET_HPS_TXD2	EMAC0 RGMII TXD2
G19	GPIO0_IO21	ENET_HPS_TXD3	EMAC0 RGMII TXD3
F22	GPIO0_IO22	ENET_HPS_RXD2	EMAC0 RGMII RXD2
G22	GPIO0_IO23	ENET_HPS_RXD3	EMAC0 RGMII RXD3
H23	GPIO1_IO8	ENETB_MDIO	EMAC2 MDIO
J23	GPIO1_IO9	ENETB_MDC	EMAC2 MDIO
K21	GPIO1_IO10	ENET_HPS_MDIO	EMAC2 MDIO
K20	GPIO1_IO11	ENET_HPS_MDC	EMAC2 MDIO

The Micrel KSZ9031RN PHY uses a multi-level POR bootstrap encoding scheme to allow a small set of I/O pins (7) to set up a very large number of default settings within the device. The related I/O pins have integrated pull-up or pull-down resistors to configure the device.

Table 5-16: Ethernet PHY (HPS) Bootstrap Encoding Scheme

Board Reference (U12)	Schematic Signal Name	Description	Strapping Option
17	ENET_HPS_LED1_LINK	PHY address bit 0	Pulled high
15	ENET_HPS_LED2_LINK	PHY address bit 1	Pulled high
32	ENET_HPS_RXD0	Mode 0	Pulled high
31	ENET_HPS_RXD1	Mode 1	Pulled high
28	ENET_HPS_RXD2	Mode 2	Pulled high
27	ENET_HPS_RXD3	Mode 3	Pulled high
35	ENET_HPS_RX_CLK	PHY address bit 2	Pulled high
33	ENET_HPS_RX_DV	Clock enable	Pulled low
41	CLK125_NDO_LED_MODE	Single LED mode	Pulled high

10/100/1000 Ethernet (FPGA)

The development board supports two RJ45 10/100/1000 base-T Ethernet using Marvell 88E1111. SGMII AC coupling interface is used between PHY and FPGA transceiver.

Figure 5-6: MII Interface between FPGA (MAC) and PHY

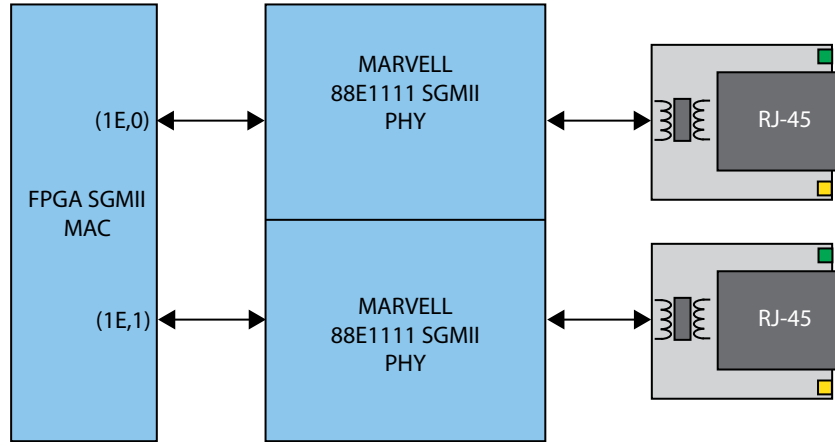

Table 5-17: Ethernet (FPGA) Pin Assignments

FPGA Pin Assignment	Schematic Signal Name	Direction	Description
AK38	ENETA_TX_N	Output	Ethernet Port A Transmitter
AK39	ENETA_TX_P	Output	Ethernet Port A Transmitter
AG32	ENETA_RX_N	Input	Ethernet Port A Receiver
AG33	ENETA_RX_P	Input	Ethernet Port A Receiver
AL36	ENETB_TX_N	Output	Ethernet Port B Transmitter
AL37	ENETB_TX_P	Output	Ethernet Port B Transmitter
AH34	ENETB_RX_N	Input	Ethernet Port B Receiver
AH35	ENETB_RX_P	Input	Ethernet Port B Receiver
AG29	CLK_ENET_FPGA_P	Input	125MHz Reference clock from Clock Synthesizer
AG28	CLK_ENET_FPGA_N	Input	125MHz Reference clock from Clock Synthesizer

FMC

The FMCA slot is compliant with the V57.1 spec. All FMC V57.1 1.8V daughtercards can be plugged into the FMCA slot. The FMCB slot is designed based on the Altera 16-transceiver FMCB specification.

Note: Check the signal connections if your FMC card must be put in the FMCB slot.

Table 5-18: FMC Port A Transceiver Pin Assignments

FPGA Pin Assignment	Schematic Signal Name	Direction	Description
E36	FAD9C2MN	Output	FMCA Slot Channel 9 transmitter
E37	FAD9C2MP	Output	FMCA Slot Channel 9 transmitter
K30	FAD9M2CN	Input	FMCA Slot Channel 9 receiver
K31	FAD9M2CP	Input	FMCA Slot Channel 9 receiver
F34	FAD8C2MN	Output	FMCA Slot Channel 8 transmitter
F35	FAD8C2MP	Output	FMCA Slot Channel 8 transmitter
K34	FAD8M2CN	Input	FMCA Slot Channel 8 receiver
K35	FAD8M2CP	Input	FMCA Slot Channel 8 receiver
F38	FAD7C2MN	Output	FMCA Slot Channel 7 transmitter
F39	FAD7C2MP	Output	FMCA Slot Channel 7 transmitter
L32	FAD7M2CN	Input	FMCA Slot Channel 7 receiver
L33	FAD7M2CP	Input	FMCA Slot Channel 7 receiver
G36	FAD6C2MN	Output	FMCA Slot Channel 6 transmitter
G37	FAD6C2MP	Output	FMCA Slot Channel 6 transmitter
M30	FAD6M2CN	Input	FMCA Slot Channel 6 receiver
M31	FAD6M2CP	Input	FMCA Slot Channel 6 receiver
L29	LMK_FMCLK_P	input	FMCA reference clock from Clock cleaner

FPGA Pin Assignment	Schematic Signal Name	Direction	Description
L28	LMK_FMCLK_N	input	FMCA reference clock from Clock cleaner
N29	FAGBTCLK0M2CP	input	FMCA SLOT reference Clock 0
N28	FAGBTCLK0M2CN	input	FMCA SLOT reference Clock 0
H38	FAD5C2MN	Output	FMCA Slot Channel 5 transmitter
H39	FAD5C2MP	Output	FMCA Slot Channel 5 transmitter
M34	FAD5M2CN	Input	FMCA Slot Channel 5 receiver
M35	FAD5M2CP	Input	FMCA Slot Channel 5 receiver
J36	FAD4C2MN	Output	FMCA Slot Channel 4 transmitter
J37	FAD4C2MP	Output	FMCA Slot Channel 4 transmitter
N32	FAD4M2CN	Input	FMCA Slot Channel 4 receiver
N33	FAD4M2CP	Input	FMCA Slot Channel 4 receiver
K38	FAD3C2MN	Output	FMCA Slot Channel 3 transmitter
K39	FAD3C2MP	Output	FMCA Slot Channel 3 transmitter
P30	FAD3M2CN	Input	FMCA Slot Channel 3 receiver
P31	FAD3M2CP	Input	FMCA Slot Channel 3 receiver
L36	FAD2C2MN	Output	FMCA Slot Channel 2 transmitter
L37	FAD2C2MP	Output	FMCA Slot Channel 2 transmitter
P34	FAD2M2CN	Input	FMCA Slot Channel 2 receiver
P35	FAD2M2CP	Input	FMCA Slot Channel 2 receiver
M38	FAD1C2MN	Output	FMCA Slot Channel 1 transmitter

FPGA Pin Assignment	Schematic Signal Name	Direction	Description
M39	FAD1C2MP	Output	FMCA Slot Channel 1 transmitter
R32	FAD1M2CN	Input	FMCA Slot Channel 1 receiver
R33	FAD1M2CP	Input	FMCA Slot Channel 1 receiver
N36	FAD0C2MN	Output	FMCA Slot Channel 0 transmitter
N37	FAD0C2MP	Output	FMCA Slot Channel 0 transmitter
T30	FAD0M2CN	Input	FMCA Slot Channel 0 receiver
T31	FAD0M2CP	Input	FMCA Slot Channel 0 receiver
R29	FAGBTCLK1M2CP	input	FMCA SLOT reference Clock 1
R28	FAGBTCLK1M2CN	input	FMCA SLOT reference Clock 1

Table 5-19: FMC Port B Transceiver Pin Assignments

FPGA Pin Assignment	Schematic Signal Name	Direction	Description
U29	REFCLK1_FMCB_P	input	FMCB Reference Clock 1 from Clock synthesizer
U28	REFCLK1_FMCB_N	input	FMCB Reference Clock 1 from Clock synthesizer
P38	FBD15C2MN	Output	FMCB Slot Channel 15 transmitter
P39	FBD15C2MP	Output	FMCB Slot Channel 15 transmitter
T34	FBD15M2CN	Input	FMCB Slot Channel 15 receiver
T35	FBD15M2CP	Input	FMCB Slot Channel 15 receiver
R36	FBD14C2MN	Output	FMCB Slot Channel 14 transmitter
R37	FBD14C2MP	Output	FMCB Slot Channel 14 transmitter
U32	FBD14M2CN	Input	FMCB Slot Channel 14 receiver

FPGA Pin Assignment	Schematic Signal Name	Direction	Description
U33	FBD14M2CP	Input	FMCB Slot Channel 14 receiver
T38	FBD13C2MN	Output	FMCB Slot Channel 13 transmitter
T39	FBD13C2MP	Output	FMCB Slot Channel 13 transmitter
V30	FBD13M2CN	Input	FMCB Slot Channel 13 receiver
V31	FBD13M2CP	Input	FMCB Slot Channel 13 receiver
U36	FBD12C2MN	Output	FMCB Slot Channel 12 transmitter
U37	FBD12C2MP	Output	FMCB Slot Channel 12 transmitter
V34	FBD12M2CN	Input	FMCB Slot Channel 12 receiver
V35	FBD12M2CP	Input	FMCB Slot Channel 12 receiver
V38	FBD11C2MN	Output	FMCB Slot Channel 11 transmitter
V39	FBD11C2MP	Output	FMCB Slot Channel 11 transmitter
W32	FBD11M2CN	Input	FMCB Slot Channel 11 receiver
W33	FBD11M2CP	Input	FMCB Slot Channel 11 receiver
W36	FBD10C2MN	Output	FMCB Slot Channel 10 transmitter
W37	FBD10C2MP	Output	FMCB Slot Channel 10 transmitter
Y30	FBD10M2CN	Input	FMCB Slot Channel 10 receiver
Y31	FBD10M2CP	Input	FMCB Slot Channel 10 receiver
W29	FBGBTCLK1M2CP	input	Reference Clock from FMCB slot channel 1
W28	FBGBTCLK1M2CN	input	Reference Clock from FMCB slot channel 1
AM38	FBD7C2MN	Output	FMCB Slot Channel 7 transmitter or PCIE EP Channel 7 transmitter

FPGA Pin Assignment	Schematic Signal Name	Direction	Description
AM39	FBD7C2MP	Output	FMCB Slot Channel 7 transmitter or PCIE EP Channel 7 transmitter
AH30	FBD7M2CN	Input	FMCB Slot Channel 7 receiver or PCIE EP Channel 7 receiver
AH31	FBD7M2CP	Input	FMCB Slot Channel 7 receiver or PCIE EP Channel 7 receiver
AN36	FBD6C2MN	Output	FMCB Slot Channel 6 transmitter or PCIE EP Channel 6 transmitter
AN37	FBD6C2MP	Output	FMCB Slot Channel 6 transmitter or PCIE EP Channel 6 transmitter
AJ32	FBD6M2CN	Input	FMCB Slot Channel 6 receiver or PCIE EP Channel 6 receiver
AJ33	FBD6M2CP	Input	FMCB Slot Channel 6 receiver or PCIE EP Channel 6 receiver
AP38	FBD5C2MN	Output	FMCB Slot Channel 5 transmitter or PCIE EP Channel 5 transmitter
AP39	FBD5C2MP	Output	FMCB Slot Channel 5 transmitter or PCIE EP Channel 5 transmitter
AK34	FBD5M2CN	Input	FMCB Slot Channel 5 receiver or PCIE EP Channel 5 receiver
AK35	FBD5M2CP	Input	FMCB Slot Channel 5 receiver or PCIE EP Channel 5 receiver
AP34	FBD4C2MN	Output	FMCB Slot Channel 4 transmitter or PCIE EP Channel 4 transmitter
AP35	FBD4C2MP	Output	FMCB Slot Channel 4 transmitter or PCIE EP Channel 4 transmitter
AK30	FBD4M2CN	Input	FMCB Slot Channel 4 receiver or PCIE EP Channel 4 receiver

FPGA Pin Assignment	Schematic Signal Name	Direction	Description
AK31	FBD4M2CP	Input	FMCB Slot Channel 4 receiver or PCIE EP Channel 4 receiver
AR36	FBD3C2MN	Output	FMCB Slot Channel 3 transmitter or PCIE EP Channel 3 transmitter
AR37	FBD3C2MP	Output	FMCB Slot Channel 3 transmitter or PCIE EP Channel 3 transmitter
AL32	FBD3M2CN	Input	FMCB Slot Channel 3 receiver or PCIE EP Channel 3 receiver
AL33	FBD3M2CP	Input	FMCB Slot Channel 3 receiver or PCIE EP Channel 3 receiver
AT38	FBD2C2MN	Output	FMCB Slot Channel 2 transmitter or PCIE EP Channel 2 transmitter
AT39	FBD2C2MP	Output	FMCB Slot Channel 2 transmitter or PCIE EP Channel 2 transmitter
AM34	FBD2M2CN	Input	FMCB Slot Channel 2 receiver or PCIE EP Channel 2 receiver
AM35	FBD2M2CP	Input	FMCB Slot Channel 2 receiver or PCIE EP Channel 2 receiver
AL29	REFCLK0_FMCB_P	Input	FMCB Reference Clock 0 from Clock synthesizer
AL28	REFCLK0_FMCB_N	Input	FMCB Reference Clock 0 from Clock synthesizer
AN29	FBGBTCLK0M2CP	Input	FMCB slot reference clock channel 0 or PCIE EP reference clock
AN28	FBGBTCLK0M2CN	Input	FMCB slot reference clock channel 0 or PCIE EP reference clock
AT34	FBD1C2MN	Output	FMCB Slot Channel 1 transmitter or PCIE EP Channel 1 transmitter

FPGA Pin Assignment	Schematic Signal Name	Direction	Description
AT35	FBD1C2MP	Output	FMCB Slot Channel 1 transmitter or PCIE EP Channel 1 transmitter
AM30	FBD1M2CN	Input	FMCB Slot Channel 1 receiver or PCIE EP Channel 1 receiver
AM31	FBD1M2CP	Input	FMCB Slot Channel 1 receiver or PCIE EP Channel 1 receiver
AU36	FBD0C2MN	Output	FMCB Slot Channel 0 transmitter or PCIE EP Channel 0 transmitter
AU37	FBD0C2MP	Output	FMCB Slot Channel 0 transmitter or PCIE EP Channel 0 transmitter
AN32	FBD0M2CN	Input	FMCB Slot Channel 0 receiver or PCIE EP Channel 0 receiver
AN33	FBD0M2CP	Input	FMCB Slot Channel 0 receiver or PCIE EP Channel 0 receiver
AV38	FBD9C2MN	Output	FMCB Slot Channel 9 transmitter
AV39	FBD9C2MP	Output	FMCB Slot Channel 9 transmitter
AP30	FBD9M2CN	Input	FMCB Slot Channel 9 receiver
AP31	FBD9M2CP	Input	FMCB Slot Channel 9 receiver
AV34	FBD8C2MN	Output	FMCB Slot Channel 8 transmitter
AV35	FBD8C2MP	Output	FMCB Slot Channel 8 transmitter
AR32	FBD8M2CN	Input	FMCB Slot Channel 8 receiver
AR33	FBD2M2CP	Input	FMCB Slot Channel 8 receiver

The FMCA slot is designed to be compatible with the requirements of FMC V57.1. This slot can be used to support an external FMC memory card (DDR3 or DDR4).

Table 5-20: FMCA LVDS Signal I/O Assignment

BANK	Pin Number	Schematic Signal Name	DDR3 Interface (optional)	DDR4 Interface (optional)
3H	P15	FAHAN0	DDR3 DQ4	DDR4 DQ4
3H	P14	FAHAP0	DDR3 DM0	DDR4 LDM_n0
3H	N14	FAHAN1	DDR3 DQ5	DDR4 DQ5
3H	M14	FAHAP1	DDR3 DQ6	DDR4 DQ6
3H	J14	FAHAN2	DDR3 DQ1	DDR4 DQ1
3H	J13	FAHAP2	DDR3 DQ0	DDR4 DQ0
3H	L15	FAHAN3	DDR3 DQS 0n	DDR4 DQSL_n0
3H	L14	FAHAP3	DDR3 DQS 0p	DDR4 DQSL_p0
3H	L13	FAHAN4	DDR3 DQ2	DDR4 DQ2
3H	L12	FAHAP4	DDR3 DQ3	DDR4 DQ3
3H	K13	FAHAN5	DDR3 DQ7	DDR4 DQ7
3H	K12	FAHAP5		
3H	H14	FALAN0	DDR3 DQ9	DDR4 DQ9
3H	G14	FALAP0	DDR3 DQ8	DDR4 DQ8
3H	D14	FALAN3	DDR3 DQ11	DDR4 DQ11
3H	C14	FALAP3	DDR3 DQ10	DDR4 DQ10
3H	D13	FALAN2	DDR3 DQ14	DDR4 DQ14
3H	C13	FALAP2	DDR3 DQ12	DDR4 DQ12
3H	E13	FA_LA_DEVCLK_N	DDR3 DQS1n	DDR4 DQSU0n
3H	E12	FA_LA_DEVCLK_P	DDR3 DQS1p	DDR4 DQSU0p
3H	H13	FALAN4	DDR3 DQ13	DDR4 DQ13
3H	H12	FALAP4	240-Ohm reference resistor	240-Ohm reference resistor
3H	F14	FA_LA_SYSREF_N	DDR3 DQ15	DDR4 DQ15
3H	F13	FA_LA_SYSREF_P	DDR3 DM1	DDR4 UDM_n0
3H	C12	FAHAN6	DDR3 DQ20	DDR4 DQ20
3H	C11	FAHAP6	DDR3 DQ22	DDR4 DQ22
3H	E11	FAHAN7	DDR3 DQ17	DDR4 DQ17
3H	D11	FAHAP7	DDR3 DQ18	DDR4 DQ18
3H	G12	FAHAN8	DDR3 DQ19	DDR4 DQ19
3H	F12	FAHAP8	DDR3 DQ16	DDR4 DQ16

BANK	Pin Number	Schematic Signal Name	DDR3 Interface (optional)	DDR4 Interface (optional)
3H	G10	FAHAN9	DDR3 DQSn2	DDR4 DQSL1n
3H	F10	FAHAP9	DDR3 DQSp2	DDR4 DQSL1p
3H	E10	FAHAN10	DDR3 DM2	DDR4 LDM_n1
3H	D10	FAHAP10	DDR3 DQ21	DDR4 DQ21
3H	H11	FAHAN11	DDR3DQ23	DDR4DQ23
3H	G11	FAHAP11		
3H	B10	FALAN6	DDR3 DMA3	DDR4 UDM_n1
3H	A10	FALAP6	DDR3 DQ31	DDR4 DQ31
3H	B9	FALAN7	DDR3 DQ30	DDR4 DQ30
3H	A9	FALAP7		
3H	B12	FALAN8	DDR3 DQ29	DDR4 DQ29
3H	B11	FALAP8	DDR3 DQ28	DDR4 DQ28
3H	A13	FALAN9	DDR3 DQSn3	DDR4 DQSU1n
3H	A12	FALAP9	DDR3 DQSp3	DDR4 DQSU1p
3H	A8	FALAN10	DDR3 DQ25	DDR4 DQ25
3H	A7	FALAP10	DDR3 DQ26	DDR4 DQ26
3H	D9	FALAN11	DDR3 DQ24	DDR4 DQ24
3H	C9	FALAP11	DDR3 DQ27	DDR4 DQ27
3G	F8	FAHAN12	DQ of DDR3 Byte 8	DQ of DDR4 Byte 8
3G	E8	FAHAP12	DQ of DDR3 Byte 8	DQ of DDR4 Byte 8
3G	C7	FAHAN13	DM of DDR3 Byte 8	DM of DDR4 Byte 8
3G	B7	FAHAP13	DQ of DDR3 Byte 8	DQ of DDR4 Byte 8
3G	D8	FAHAN14	DQ of DDR3 Byte 8	DQ of DDR4 Byte 8
3G	C8	FAHAP14	DQ of DDR3 Byte 8	DQ of DDR4 Byte 8
3G	C6	FAHAN15	DQS of DDR3 byte 8	DQS of DDR4 byte 8
3G	B6	FAHAP15	DQS of DDR3 byte 8	DQS of DDR4 byte 8
3G	B5	FAHAN16	DQ of DDR3 Byte 8	DQ of DDR4 Byte 8

BANK	Pin Number	Schematic Signal Name	DDR3 Interface (optional)	DDR4 Interface (optional)
3G	A5	FAHAP16	DQ of DDR3 Byte 8	DQ of DDR4 Byte 8
3G	B4	FAHAN17	DQ of DDR3 Byte 8	DQ of DDR4 Byte 8
3G	A4	FAHAP17	No use	DDR4 Alertn
3G	C4	FALAN12	BA2 of DDR3 Bnak Address line	BG0 of DDR4 Group line
3G	C3	FALAP12	BA1 of DDR3 Bank address line	BA1 of DDR4 BANK address line
3G	D3	FALAN13	BA0 of DDR3 BANK address line	BA0 of DDR4 BANK address line
3G	C2	FALAP13	CASn of DDR3 Control line	A17 of DDR4 address line
3G	F7	FALAN14	RASn of DDR3 Control line	A16 of DDR4 address line
3G	E7	FALAP14	A15 of DDR3 Address line	A15 of DDR4 Address line
3G	D5	FALAN15	A14 of DDR3 Address line	A14 of DDR4 Address line
3G	D4	FALAP15	A13 of DDR3 Address line	A13 of DDR4 Address line
3G	E6	FALAN16	A12 of DDR3 Address line	A12 of DDR4 Address line
3G	D6	FALAP16	240-Ohm reference resistor	240-Ohm reference resistor
3G	F5	FA_EMI_CLKN	133Mhz DDR reference clock	133Mhz DDR reference clock
3G	E5	FA_EMI_CLKP	133Mhz DDR reference clock	133Mhz DDR reference clock
3G	H9	FALAN17	A11 of DDR3 Address line	A11 of DDR4 Address line
3G	H8	FALAP17	A10 of DDR3 Address line	A10 of DDR4 Address line
3G	G9	FAHAN18	A9 of DDR3 Address line	A9 of DDR4 Address line
3G	F9	FAHAP18	A8 of DDR3 Address line	A8 of DDR4 Address line

BANK	Pin Number	Schematic Signal Name	DDR3 Interface (optional)	DDR4 Interface (optional)
3G	K8	FPGA_RCLK_3Gn	A7 of DDR3 Address line	A7 of DDR4 Address line
3G	J8	FPGA_RCLK_3Gp	A6 of DDR3 Address line	A6 of DDR4 Address line
3G	G6	FAHAN19	A5 of DDR3 Address line	A5 of DDR4 Address line
3G	G5	FAHAP19	A4 of DDR3 Address line	A4 of DDR4 Address line
3G	H7	FAHAN20	A3 of DDR3 Address line	A3 of DDR4 Address line
3G	G7	FAHAP20	A2 of DDR3 Address line	A2 of DDR4 Address line
3G	J6	FAHAN21	A1 of DDR3 Address line	A1 of DDR4 Address line
3G	H6	FAHAP21	A0 of DDR3 Address line	A0 of DDR4 Address line
3G	L10	FAHAN22	No use	DDR4 PAR
3G	K10	FAHAP22	No use	CSN1 of DDR4 control line
3G	K11	FAHAN23	DDR3 interface clock	DDR4 interface clock
3G	J11	FAHAP23	DDR3 interface clock	DDR4 interface clock
3G	N13	FALAN18	DDR3 ClKe1	DDR4 CKe1
3G	M12	FALAP18	DDR3 CKe0	DDR4 CKe0
3G	N11	FALAN19	DDR3 ODT1	DDR4 ODT1
3G	M10	FALAP19	DDR3 ODT0	DDR4 ODT0
3G	J10	FALAN20	DDR3 CSn1	DDR4 ACTn
3G	J9	FALAP20	DDR3 CSn0	DDR4 CSn0
3G	N12	FALAN21	DDR3 Resetn	DDR4 Resetn
3G	M11	FALAP21	DDR3 Wen	DDR4 BG1
3F	G4	FALAN22	DDR3 DQ4	DDR4 DQ4
3F	F4	FALAP22	DDR3 DM0	DDR4 LDM_n0
3F	D1	FALAN23	DDR3 DQ5	DDR4 DQ5
3F	C1	FALAP23	DDR3 DQ6	DDR4 DQ6
3F	E2	FALAN24	DDR3 DQ1	DDR4 DQ1
3F	E1	FALAP24	DDR3 DQ0	DDR4 DQ0

BANK	Pin Number	Schematic Signal Name	DDR3 Interface (optional)	DDR4 Interface (optional)
3F	F3	FALAN25	DDR3 DQS 0n	DDR4 DQSL_n0
3F	E3	FALAP25	DDR3 DQS 0p	DDR4 DQSL_p0
3F	G2	FALAN26	DDR3 DQ2	DDR4 DQ2
3F	F2	FALAP26	DDR3 DQ3	DDR4 DQ3
3F	H2	FALAN27	DDR3 DQ7	DDR4 DQ7
3F	G1	FALAP27		
3F	J5	FAHBN0	DDR3 DQ9	DDR4 DQ9
3F	J4	FAHBP0	DDR3 DQ8	DDR4 DQ8
3F	J1	FAHBN1	DDR3 DQ11	DDR4 DQ11
3F	H1	FAHBP1	DDR3 DQ10	DDR4 DQ10
3F	H4	FAHBN2	DDR3 DQ14	DDR4 DQ14
3F	H3	FAHBP2	DDR3 DQ12	DDR4 DQ12
3F	K2	FAHBN3	DDR3 DQS1n	DDR4 DQSU0n
3F	K1	FAHBP3	DDR3 DQS1p	DDR4 DQSU0p
3F	L3	FAHBN4	DDR3 DQ13	DDR4 DQ13
3F	L2	FAHBP4	240-Ohm reference resistor	240-Ohm reference resistor
3F	K3	FAHBN5	DDR3 DQ15	DDR4 DQ15
3F	J3	FAHBP5	DDR3 DM1	DDR4 UDM_n0
3F	N7	FAHBN6	DDR3 DQ20	DDR4 DQ20
3F	N6	FAHBP6	DDR3 DQ22	DDR4 DQ22
3F	K6	FAHBN7	DDR3 DQ17	DDR4 DQ17
3F	K5	FAHBP7	DDR3 DQ18	DDR4 DQ18
3F	L7	FAHBN8	DDR3 DQ19	DDR4 DQ19
3F	K7	FAHBP8	DDR3 DQ16	DDR4 DQ16
3F	M7	FAHBN9	DDR3 DQSn2	DDR4 DQSL1n
3F	M6	FAHBP9	DDR3 DQSp2	DDR4 DQSL1p
3F	M4	FAHBN10	DDR3 DM2	DDR4 LDM_n1
3F	L4	FAHBP10	DDR3 DQ21	DDR4 DQ21
3F	M5	FALAN28	DDR3DQ23	DDR4DQ23
3F	L5	FALAP28		
3F	P10	FALAN29	DDR3 DMA3	DDR4 UDM_n1
3F	N9	FALAP29	DDR3 DQ31	DDR4 DQ31

BANK	Pin Number	Schematic Signal Name	DDR3 Interface (optional)	DDR4 Interface (optional)
3F	M9	FAHBN13	DDR3 DQ30	DDR4 DQ30
3F	N8	FAHBP13		
3F	R10	FALAN30	DDR3 DQ29	DDR4 DQ29
3F	P9	FALAP30	DDR3 DQ28	DDR4 DQ28
3F	R8	FALAN31	DDR3 DQSn3	DDR4 DQSU1n
3F	P8	FALAP31	DDR3 DQSp3	DDR4 DQSU1p
3F	R11	FALAN33	DDR3 DQ25	DDR4 DQ25
3F	P11	FALAP33	DDR3 DQ26	DDR4 DQ26
3F	L9	FALAN32	DDR3 DQ24	DDR4 DQ24
3F	L8	FALAP32	DDR3 DQ27	DDR4 DQ27

Table 5-21: FMCB LVDS signal IO assignment

BANK	Pin Number	Schematic Signal Name
3E	U7	FBHA_N6
3E	T7	FBHA_P6
3E	U6	FPGA_Refsys_3En
3E	U5	FPGA_Refsys_3Ep
3E	V7	FBHA_P17
3E	V6	FBHA_N17
3E	W6	Refclk_3En
3E	W5	Refclk_3Ep
3E	U4	FBLAN20
3E	T4	FBLAP20
3E	T3	FBLAN21
3E	T2	FBLAP21
3E	U2	FBLAN22
3E	U1	FBLAP22
3E	V2	FBLAN23
3E	V1	FBLAP23
3E	W4	FBLAN24
3E	W3	FBLAP24
3E	V4	FBLAN25
3E	V3	FBLAP25

BANK	Pin Number	Schematic Signal Name
3E	U10	FBLAN26
3E	U9	FBLAP26
3E	V9	FBLAN27
3E	V8	FBLAP27
3E	T9	FBHA_N23
3E	T8	FBHA_P23
3E	W10	FBHA_N20
3E	W9	FBHA_P20
3E	V11	FBHA_N21
3E	U11	FBHA_P21
3E	R7	FBHA_N22
3E	R6	FBHA_P22
3A	AU7	FBLAN0
3A	AV7	FBLAP0
3A	AT8	FB_LA_DEVCLK_N
3A	AT7	FB_LA_DEVCLK_P
3A	AT10	FBLAN2
3A	AT9	FBLAP2
3A	AV8	FBLAN3
3A	AW8	FBLAP3
3A	AU9	FBLAN4
3A	AV9	FBLAP4
3A	AW10	FB_LA_SYSREF_N
3A	AW9	FB_LA_SYSREF_P
3A	AP8	FBLAN6
3A	AR8	FBLAP6
3A	AU11	FBLAN7
3A	AU10	FBLAP7
3A	AN9	FBLAN8
3A	AP9	FBLAP8
3A	AP10	FBLAN9
3A	AR10	FBLAP9
3A	AR12	FBLAN10
3A	AT12	FBLAP10

BANK	Pin Number	Schematic Signal Name
3A	AP11	FBCLK0M2CN
3A	AR11	FBCLK0M2CP
3A	AL10	Refclk_3An
3A	AM10	Refclk_3Ap
3A	AK12	FBLAN11
3A	AK11	FBLAP11
3A	AL12	FBLAN12
3A	AM12	FBLAP12
3A	AM11	FBLAN13
3A	AN11	FBLAP13
3A	AL14	FBLAN14
3A	AL13	FBLAP14
3A	AN13	FBLAN15
3A	AN12	FBLAP15
3A	AJ15	FBLAN16
3A	AK15	FBLAP16
3A	AH13	FBLAN17
3A	AH12	FBLAP17
3A	AJ13	FBLAN18
3A	AK13	FBLAP18
3A	AF14	FBLAN19
3A	AG14	FBLAP19
3A	AH14	FMB_SYNC_AB
3A	AJ14	FMB_SYNC_CD
3A	AF15	FMB_SYNCN
3A	AG15	FMB_SYNCP

HPS Shared I/O

Table 5-22: HPS Shared I/O

Pin Number	Shared I/O Bit	Schematic Signal Name	Description
D18	GPIO0_IO0	USB_CLK	USB2.0 Clock
E18	GPIO0_IO1	USB_STP	USB2.0 Stop bit
C19	GPIO0_IO2	USB_DIR	USB2.0 direction bit
D19	GPIO0_IO3	USB_DATA0	USB2.0 data line 0
E17	GPIO0_IO4	USB_DATA1	USB2.0 data line 1
F17	GPIO0_IO5	USB_NXT	USB2.0 NXT flag
C17	GPIO0_IO6	USB_DATA2	USB2.0 data line 2
C18	GPIO0_IO7	USB_DATA3	USB2.0 data line 3
D21	GPIO0_IO8	USB_DATA4	USB2.0 data line 4
D20	GPIO0_IO9	USB_DATA5	USB2.0 data line 5
E21	GPIO0_IO10	USB_DATA6	USB2.0 data line 6
E22	GPIO0_IO11	USB_DATA7	USB2.0 data line 7
H18	GPIO0_IO12	ENET_HPS_GTX_CLK	EMAC0 RGMII TX Clock
H19	GPIO0_IO13	ENET_HPS_TX_EN	EMAC0 RGMII
F18	GPIO0_IO14	ENET_HPS_RX_CLK	EMAC0 RGMII RX Clock
G17	GPIO0_IO15	ENET_HPS_RX_DV	EMAC0 RGMII RX DV flag
E20	GPIO0_IO16	ENET_HPS_TXD0	EMAC0 RGMII TXD0
F20	GPIO0_IO17	ENET_HPS_TXD1	EMAC0 RGMII TXD1
G20	GPIO0_IO18	ENET_HPS_RXD0	EMAC0 RGMII RXD0
G21	GPIO0_IO19	ENET_HPS_RXD1	EMAC0 RGMII RXD1
F19	GPIO0_IO20	ENET_HPS_TXD2	EMAC0 RGMII TXD2
G19	GPIO0_IO21	ENET_HPS_TXD3	EMAC0 RGMII TXD3
F22	GPIO0_IO22	ENET_HPS_RXD2	EMAC0 RGMII RXD2
G22	GPIO0_IO23	ENET_HPS_RXD3	EMAC0 RGMII RXD3
K18	GPIO1_IO0	SPIM1_CLK	MAXV IO SPI Clock
L19	GPIO1_IO1	SPIM1_MOSI	MAXV IO SPI Master Output/Slave input
H22	GPIO1_IO2	SPIM1_MISO	MAXV IO SPI Slave Input/Master output

Pin Number	Shared I/O Bit	Schematic Signal Name	Description
H21	GPIO1_IO3	SPIM1_SS0_N	MAXV IO SPI chip select 0
J21	GPIO1_IO4	SPIM1_SS1_N	MAXV IO SPI Chip Select 1
J20	GPIO1_IO5	A10SH_GPIO0	MAXV_GPIO0
J18	GPIO1_IO6	UARTA_TX	UART port 1 TX
J19	GPIO1_IO7	UARTA_RX	UART PORT 1 RX
H23	GPIO1_IO8	ENETB_MDIO	EMAC2 MDIO
J23	GPIO1_IO9	ENETB_MDC	EMAC2 MDIC
K21	GPIO1_IO10	ENET_HPS_MDIO	EMAC0 MDIO
K20	GPIO1_IO11	ENET_HPS_MDC	EMAC0 MDIC
L20	GPIO1_IO12	SH_SDA	I ² C Port 1 SDA
M20	GPIO1_IO13	SH_SCL	I ² C Port 1 SCL
N20	GPIO1_IO14	A10SH_GPIO1	MAXV_GPIO1
P20	GPIO1_IO15	TRACE_CLK	TRACE Clock
K23	GPIO1_IO16	A10SH_GPIO2	MAXV_GPIO2
L23	GPIO1_IO17	A10SH_GPIO3	MAXV_GPIO3
N23	GPIO1_IO18	ENETA_MDIO	EMAC1 MDIO
N22	GPIO1_IO19	ENETA_MDC	EMAC1 MDIC
K22	GPIO1_IO20	TRACE_D0	TRACE D0
L22	GPIO1_IO21	TRACE_D1	TRACE D1
M22	GPIO1_IO22	TRACE_D2	TRACE D2
M21	GPIO1_IO23	TRACE_D3	TRACE D3

USB 2.0 Port (HPS)

The development supports one USB2.0 interface. The HPS USB interface is connected to a USB3320 PHY that is connected to a micro-USB connector (J4).

Table 5-23: USB 2.0 FPGA Signal Names and Functions

FPGA Pin Assignment	Shared I/O Bit	Schematic Signal Name	Description
D18	GPIO0_IO0	USB_CLK	USB2.0 Clock
E18	GPIO0_IO1	USB_STP	USB2.0 Stop bit
C19	GPIO0_IO2	USB_DIR	USB2.0 direction bit
D19	GPIO0_IO3	USB_DATA0	USB2.0 data line 0
E17	GPIO0_IO4	USB_DATA1	USB2.0 data line 1
F17	GPIO0_IO5	USB_NXT	USB2.0 NXT flag
C17	GPIO0_IO6	USB_DATA2	USB2.0 data line 2
C18	GPIO0_IO7	USB_DATA3	USB2.0 data line 3
D21	GPIO0_IO8	USB_DATA4	USB2.0 data line 4
D20	GPIO0_IO9	USB_DATA5	USB2.0 data line 5
E21	GPIO0_IO10	USB_DATA6	USB2.0 data line 6
E22	GPIO0_IO11	USB_DATA7	USB2.0 data line 7

RS-232 UART (HPS)

The development board supports two UART interfaces, the HPS debug UART and the FPGA debug UART interface. The HPS debug UART is connected to a mini-USB connector (J10) using a FT232RQ-REEL USB-to-UART bridge. The maximum supported rate for this interface is 1 Mbps. The FGPA debug UART is connected to the DB9 connector (J25) using a MAX3221 UART PHY. Board reference D11 and D12 are the HPS debug UART LEDs that illuminate to indicate TX and RX activity.

Table 5-24: UART FPGA Signal Names and Functions

FPGA Pin Assignment	Shared I/O Bit	Schematic Signal Name	Description
J18	GPIO1_IO6	UARTA_TX	HPS debug UART port 1 TX
J19	GPIO1_IO7	UARTA_RX	HPS debug UART PORT 1 RX
AV22	-	CVP_CONFDONE	HPS UART0 TX after FPGA configuration
AU21	-	CRCEERROR	HPS UART0 RX after FPGA configuration

Real-Time Clock (HPS)

The HPS system has a battery-backed real-time clock (RTC) connected through the I²C interface. The RTC is implemented using a DS1339 device from Maxim Semiconductor. The device has a built-in power sense circuit that detects power failures and automatically switches to the backup battery supply, maintaining time. The device uses a CR1225 lithium coin battery with a nominal voltage of 3 V.

Note: A battery for the RTC is not shipped with the development kit.

SFP+

The development board include two SFP+ ports that use two transceiver channels from the FPGA. These ports take in serial data from the FPGA and transforms it into optical signals. Both SFP+ ports are active and include the SFP+ cage assembly.

Table 5-25: SFP+ FPGA Transceiver Pin Assignments

FPGA Pin Assignment	Schematic Signal Name	Direction	Description
AW36	SFPB_TX_N	Output	SFP+ B Transmitter
AW37	SFPB_TX_P	Output	SFP+ B Transmitter
AT30	SFPB_RX_N	Input	SFP+ B Receiver
AT31	SFPB_RX_P	Input	SFP+ B Receiver
AW32	SFPA_TX_N	Output	SFP+ A Transmitter
AW33	SFPA_TX_P	Output	SFP+ A Transmitter
AU32	SFPA_RX_N	Input	SFP+ A Receiver
AU33	SFPA_RX_P	Input	SFP+ A Receiver
AR29	LMK_SFPCLK_P	Input	SFP+ clock reference from clock cleaner
AR28	LMK_SFPCLK_N	Input	SFP+ clock reference from clock cleaner

I²C Interface

There is an I²C buffer connected to I²C port 1. The enable pin of the I²C buffer is controlled by the MAX V A10I2CEN. The HPS must set A10I2CEN to logic 1 before accessing the I²C devices shown in [Table 5-26](#).

Figure 5-7: I²C Bus Connection

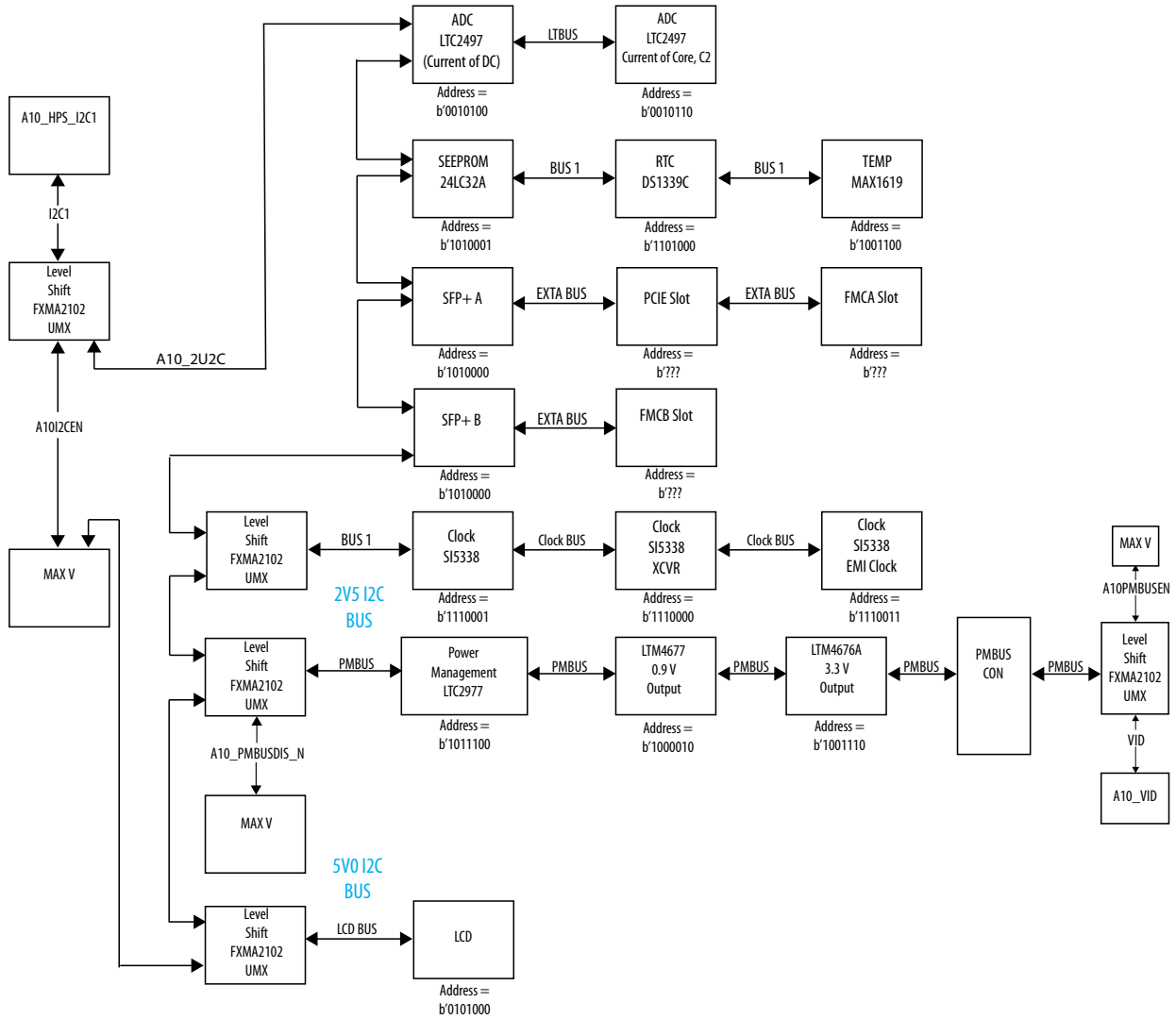

Table 5-26: I²C Device Address

Address	Device
0x14, 0x16	LT2497 ADC
0x51	24LC32A EEPROM
0x68	DS1339C Real time clock circuit
0x4C	MAX1619 Temp monitor
0x71, 0x70, 0x73	Si5338 clock generators
0x5C	LTC2977 power management
0x42	0.9V LTM4677 power controller
0x0E	3.3VLTM4676A power controller
0x28	LCD

FPGA-I/O MAX V Interface

Thirteen FPGA IO pairs (FPGAIO_NP signals) are connected to FPGA-IO MAXV CPLD for supporting FMC, Display port and SDI applications.

Table 5-27: I/O Assignments of FPGA I/O Pairs

Bank	Pin Number	Schematic Signal Name
3E	M2	FPGAIO9_N
3E	M1	FPGAIO9_P
3E	N4	FPGAIO8_N
3E	N3	FPGAIO8_P
3E	R3	FPGAIO7_N
3E	R2	FPGAIO7_P
3E	N2	FPGAIO6_N
3E	N1	FPGAIO6_P
3E	R1	FPGAIO5_N
3E	P1	FPGAIO5_P
3E	P4	FPGAIO4_N
3E	P3	FPGAIO4_P
3E	P6	FPGAIO3_N
3E	P5	FPGAIO3_P
3E	T5	FPGAIO2_N
3E	R5	FPGAIO2_P
2I	AR22	FPGAIO_N

Bank	Pin Number	Schematic Signal Name
2I	AR23	FPGAIO_P
2I	AL22	FPGAIO12_N
2I	AM22	FPGAIO12_P
2I	AP21	FPGAIO11_N
2I	AR21	FPGAIO11_P
2I	AN22	FPGAIO10_N
2I	AN21	FPGAIO10_P
2I	AL20	FPGAIO1_N
2I	AM21	FPGAIO1_P

The figure below illustrates the signal connections between two MAX Vs and FPGA.

Figure 5-8: Control Signal Connection

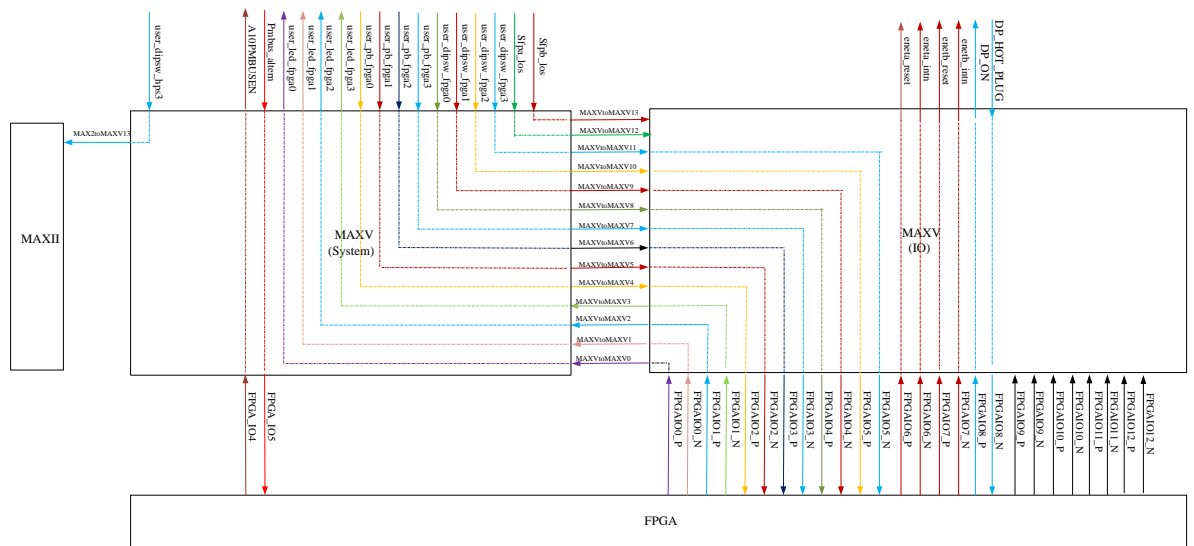

LMK04828 Controller

The TI interface uses the USB interface to access the LMK04828 clock cleaner. The LMK04828 controller passes the FT245RQ signals to the SPI interface of LMK04828 clock cleaner chip.

Figure 5-9: LMK04828 Controller

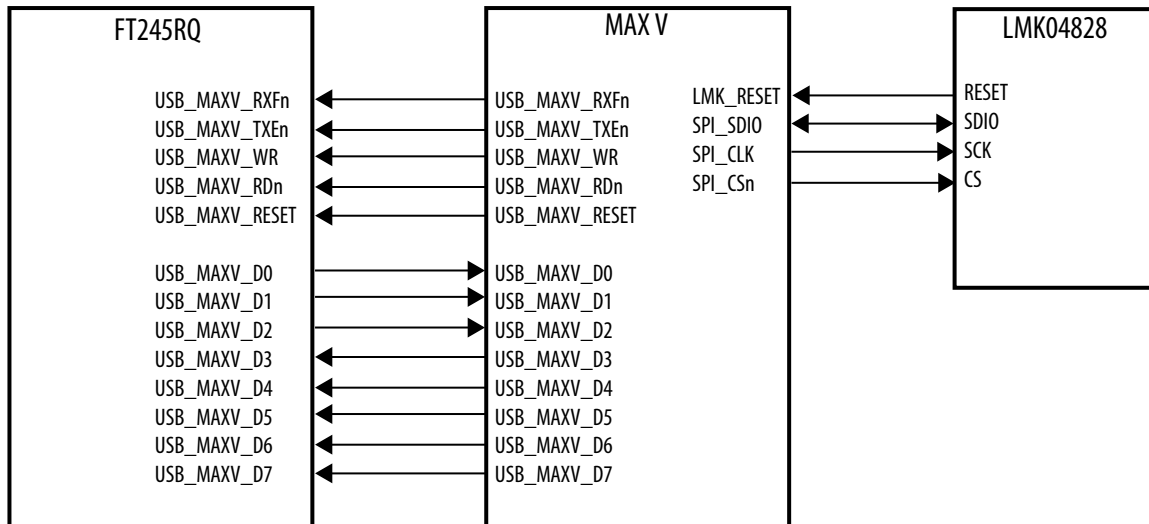

J33 is used to select reference clock sources.

Table 5-28: J33 Reference Clock sources

Description	Clock source of Clock Cleaner
OPEN	VCXO
SHORT	EXT_CLOCK

HPS SPIO Interface

The HPS can monitor and control the following functional signals through the SPI interface:

- HPS LED signals
- HPS Push button and DIP switch signals
- Power good and present signals
- Reset signals
- FMCA/B PCIE power enable signals
- SFP+ control signals
- I²C master indication signal
- HPS warm reset signals
- PMBUS control signals

Table 5-29: SPI Interface Pin Definition

Pin	Description	Function
nCS	Chip Select	Active low signal that enables the slave device to receive or transfer data from the master device
SCK	Serial Clock	The clock signal produced from the master device to synchronize the data transfer
MOSI	Serial Data Input	Receive data serially at the positive SCK clock.
MISO	Serial Data output	Transmit data serially at the negative SCK clock edge.

The HPS SPI controller is the SPI master, and the MAX V works as a slave SPI I/O expander. The SPI interface uses 8-bit frame size. For MOSI, the first byte is used as an instruction byte. Bit [7:1] is the register address. Bit [0] is the operation flag where logic '1' is read flag and logic '0' is the write flag. The second byte is the data byte. For MISO, the first byte are zero byte (pad), second byte is the data byte.

Figure 5-10: HPS SPI Controller Write Timing Diagram

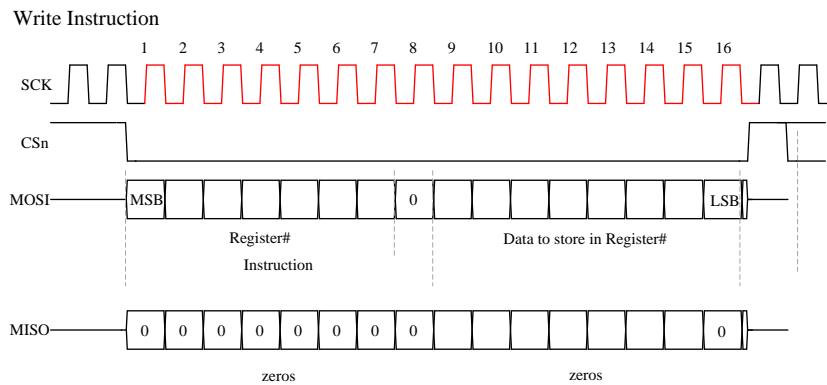

Figure 5-11: HPS SPI Write Timing (Write/Write)

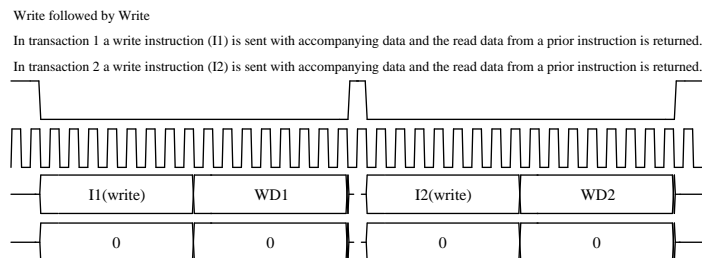

Figure 5-12: HPS SPI Read Timing Diagram

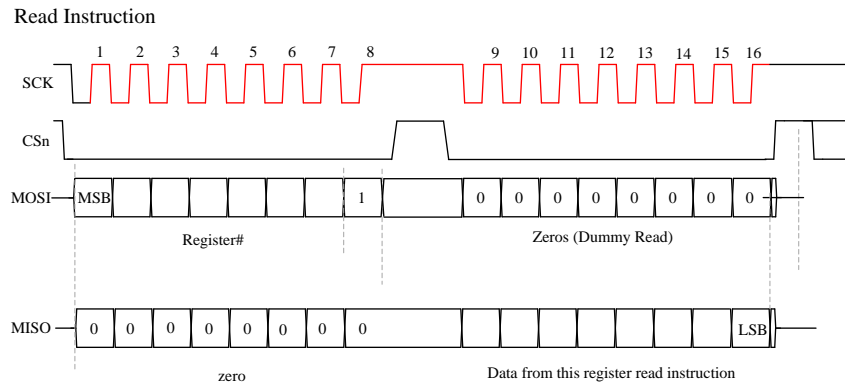

Figure 5-13: HPS SPI Read Timing (Read/Write)

Read followed by Write

In transaction 1 a read instruction (I1) is sent and the read data from a prior instruction is returned.
 In transaction 2, a 0 is written and the read data from I1 is returned. Since the 0 is a write, the read register is not updated.
 In transaction 3, a write instruction (I2) is sent with accompanying data and the read data from I1 is returned.

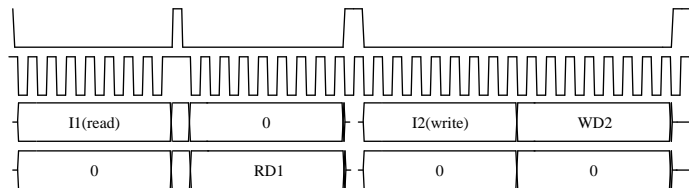
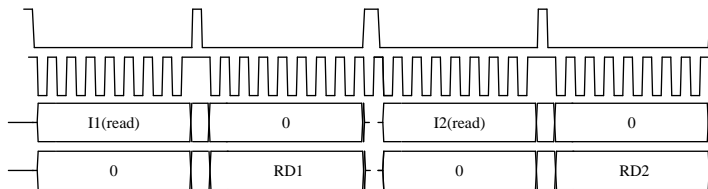

Figure 5-14: HPS SPI Read Timing (Read/Read)

Read followed by Read

In transaction 1 a read instruction (I1) is sent. The data from the last read is returned.
 On transaction 2, the read data from I1 is returned. Since a 0 is a write so the read data register is not updated for the 3rd transaction.
 In transaction 3, a read instruction (I2) is sent.
 On transaction 4, the read data from I2 is returned. 0 is sent in 2nd byte.



16 8-bit registers are implemented. For MOSI, the first byte is used as an instruction byte. Bit [7:1] is the register address. Bit [0] is the operation flag: Logic one is read flag. Logic zero is write flag. Second byte is data byte. For MISO, the first byte are zero byte (pad), second byte is data byte.

Table 5-30: SPI I/O Expander Register Definition

Instruction (8bits)	Instruction Description	Register Data Description
00000001	CPLD Revision Value	Register 0: Read-only Register Read value is the CPLD revision value
00000010	Write HPS LED Registers	Register 1: Bit[7:4] - USER_LED_HPS[3:0], Active low, default value is "0xF" Bit[3:0] - Reserved, default is "0x0"
00000011	Read HPS LED Registers	Register 1: Bit[7:4] - USER_LED_HPS[3:0] Bit[3:0] - Reserved Default value is "0xF0"
00000101	Read HPS Push Button and DIP switch registers	Register 2: Current Status of USER_PB_HPS and USER_DIPSW_HPS Bit[7:4] - USER_PB_HPS [3:0] Bit[3:0] - USER_DIPSW_HPS [3:0]
00000110	Write HPS Push Button IRQ flag clear registers	Register 3: Bit[7] - Write logic one to clear bit 7 flag in register 2, write logic zero to reset this bit after the flag is cleared Bit[6] - Write logic one to clear bit 6 flag in register 2, write logic zero to reset this bit after the flag is cleared Bit[5] - Write logic one to clear bit 5 flag in register 2 , write logic zero to reset this bit after the flag is cleared Bit[4] - Write logic one to clear bit 4 flag in register 2 , write logic zero to reset this bit after the flag is cleared

Instruction (8bits)	Instruction Description	Register Data Description
00000111	Read HPS Push Button IRQ flag Registers	<p>Register 3: Read-only Register</p> <p>Bit[7:4] - USER_PB_HPS hold registers bits</p> <p>Bit 7: USER_PB_HPS3 IRQ Flag, active low, clear flag by register 3 bit 7.</p> <p>Bit 6: USER_PB_HPS2 IRQ Flag, active low, clear flag by register3 bit 6.</p> <p>Bit 5: USER_PB_HPS1 IRQ Flag, active low, clear flag by register3 bit 5.</p> <p>Bit 4: USER_PB_HPS0 IRQ Flag, active low, clear flag by register3 bit 4.</p> <p>Bit[3:0] - reserved</p> <p>If one of the push buttons is pressed, the corresponding PB's IRQ register bit is set and A10_SH_GPIO0 is configured to '0'.</p> <p>The A10_SH_GPIO0 returns to '1' after the HPS clears the associated bit (even if the PB is still held down).</p> <p>If the second push button is pressed while the HPS is handling the first push button interrupt, the second PB's IRQ register bit remains as a '0' until HPS clears the interrupt. A10_SH_GPIO0 stays low until the HPS clears the second PB's IRQ register bit.</p>

Instruction (8bits)	Instruction Description	Register Data Description
00001001	Read Power good1 Registers	<p>Register 4: Read-only register</p> <p>Bit[7] - operation_flag. '1': Power on finished. '0': The system is in Power down cycle</p> <p>Bit[6] - 1V8_Pgood. '1':1.8V power rail output is normal. '0': 1.8V power rail output is abnormal.</p> <p>Bit[5] - 2V5_Pgood. '1':2.5V power rail output is normal. '0': 2.5V power rail output is abnormal.</p> <p>Bit[4] - 3V3_Pgood. '1':3.3V power rail output is normal. '0': 3.3V power rail output is abnormal.</p> <p>Bit[3] - 5V0_Pgood. '1':5V power rail output is normal. '0': 5V power rail output is abnormal.</p> <p>Bit[2] - 0V9_Pgood. '1':0.9V power rail output is normal. '0': 0.9V power rail output is abnormal.</p> <p>Bit[1] - 0V95_Pgood. '1':0.95V power rail output is normal. '0': 0.95V power rail output is abnormal.</p> <p>Bit[0] - 1V0_Pgood. '1':1.0V power rail output is normal. '0': 1.0V power rail output is abnormal.</p>

Instruction (8bits)	Instruction Description	Register Data Description
00001011	Read Power good2 Registers	<p>Register 5: Read-only register</p> <p>Bit[7] - HPS_Pgood. '1': HPS core power rail output is normal. '0': HPS core power rail output is abnormal.</p> <p>Bit[6] - HILOHPS_VDDPgood. '1':HPS memory power rail output is normal. '0': HPS memory power rail output is abnormal.</p> <p>Bit[5] - HILO_VDDPgood. '1':FPGA memory VDD power rail output is normal. '0': FPGA memory VDD power rail output is abnormal.</p> <p>Bit[4] - HILO_VDDQPgood . '1': FPGA memory VDDQ power rail output is normal. '0': FPGA memory VDDQ power rail output is abnormal.</p> <p>Bit[3] - FMCAVADJPGood. '1':FMCAVADJ power rail output is normal. '0': FMCAVADJ power rail output is abnormal.</p> <p>Bit[2] - FMCBVADJPGood. 1':FMCBVADJ power rail output is normal. '0': FMCBVADJ power rail output is abnormal.</p> <p>Bit[1] - FAC2MPgood. 1':FMCA slot powers are normal. '0': FMCA slot powers are abnormal.</p> <p>Bit[0] - FBC2MPgood. 1':FMCB slot powers are normal. '0': FMCB slot powers are abnormal.</p>

Instruction (8bits)	Instruction Description	Register Data Description
00001101	Read Power good3 & present Registers	<p>Register 6: Read-only Register</p> <p>Bit[7] - FAM2CPgood. '1': FMCA slot DC power outputs are normal. '0': FMCA slot DC power outputs are abnormal.</p> <p>Bit[6] - 10V_Fail_n. '1': Input voltage is above 10V. '0': Input voltage is below 10V.</p> <p>Bit[5] - BF_PRESENTn. '1': no boot flash card. '0': boot flash present</p> <p>Bit[4] - FILE_PRESENTn. '1': no file flash card. '0': file flash present</p> <p>Bit[3] - FMCA_PRESENTn. '1': no FMCA card. '0': FMCA card present</p> <p>Bit[2] - FMCB_PRESENTn. '1': no FMCB card. '0': FMCB present</p> <p>Bit[1] - PCIE_PRESENTn. '1': no PCIE card. '0': PCIE card present</p> <p>Bit[0] - Reserved</p>
00001110	Write FMCA/B PCIE Power enable Registers	<p>Register 7</p> <p>Bit[7] - PCIE_EN. '1': Enable PCIE RC slot power. '0': Disable PCIE RC slot power.</p> <p>Bit[6] - PCIE_AUXEN. '1': Enable PCIE RC slot auxiliary power. '0': Disable PCIE RC auxiliary power.</p> <p>Bit[5:0] - Reserved</p>
00001111	Read FMCA/B PCIE Power enable Registers	<p>Register 7</p> <p>Read the status of power enable register.</p>

Instruction (8bits)	Instruction Description	Register Data Description
00010000	Write HPS Resets Registers	<p>Register 8</p> <p>Bit[7] - Reserved</p> <p>Bit[6] - Reserved</p> <p>Bit[5] - Reserved</p> <p>Bit[4] - Reserved</p> <p>Bit[3] - Reserved</p> <p>Bit[2] - Reserved</p> <p>Bit[1] - ENET_HPS_RESETh. Active low to reset the HPS Ethernet port</p> <p>Bit[0] - Reserved</p>
00010001	Read HPS Reset Registers	<p>Register 8</p> <p>Bit[7] - HPS_UARTA_RESETh. Read-only bit. Always '1'</p> <p>Bit[6] - HPS_WARM_RESETh. Read-only bit. '0': WARM_Reset push button is pressed. '1' No action</p> <p>Bit[5] - HPS_WARM_RESETh. Read - only bit. '0': Trace reset is detected. '1' No action</p> <p>Bit[4] - HPS_COLD_RESETh. Read-only bit '0': Cold_Reset push button is pressed. '1' No action</p> <p>Bit[3] - HPS_NPOR. Read-only, NPOR for HPS, active low</p> <p>Bit[2] - HPS_NRST. Read-only, NRST for HPS, active low</p> <p>Bit[1] - ENET_HPS_RESETh. Read the status of ENET_HPS_RESETh</p> <p>Bit[0] - ENET_HPS_INTh. ENET_HPS_INTh current status.</p>

Instruction (8bits)	Instruction Description	Register Data Description
00010010	Write USB & BQSPI& FILE & PCIE Resets Registers	Register 9 Bit[7] - USB_RESET. Active high to reset the HPS USB. Bit[6] - BQSPI_RESETn. Active low to reset the boot flash. Bit[5] - FILE_RESETn. Active low to reset the FILE flash. Bit[4] - PCIE_PERSTn. Active low to reset the PCIE slot. Bit[3:0] - Reserved
00010011	Read USB & BQSPI& FILE & PCIE Resets Registers	Register 9 Read the status of USB & BQSPI& FILE & PCIE Resets Bit[7] - USB_RESET Bit[6] - BQSPI_RESETn Bit[5] - FILE_RESETn Bit[4] - PCIE_RESETn Bit[3:0] - Reserved
00010100	Write SFPA Control Registers	Register 10 Bit[7] - SFPA_TXDISABLE. '1': Disable SFPA TX. '0': Enable SFPA TX. Bit[6:5] - SFPA_RATESEL[1:0].SFPA RX rate selection 0: <4.25GBd1: > 4.25GBd Bit[4:0] - Reserved



Instruction (8bits)	Instruction Description	Register Data Description
00010101	Read SFPA Control Registers	<p>Register 10</p> <p>Bit[7] - SFPA_TXDISABLE. '1': Disable SFPA TX. '0': Enable SFPA TX.</p> <p>Bit[6:5] - SFPA_RATESEL[1:0].SFPA RX rate selection 0: <4.25GBd1: > 4.25GBd</p> <p>Bit[4] - SFPA_LOS. Loss signal of SFPA. '1':LOS, '0':normal.</p> <p>Bit[3] - SFPA_FAULT. Tx fault signal of SFPA. '1':fault, '0':normal.</p> <p>Bit[2] - SFPA_PRESENTn .Detect signal of SFP module in slot A . '1': no SFP module. '0': SFP module present.</p> <p>Bit[1:0] - Reserved</p>
00010110	Write SFPB Control Registers	<p>Register 11</p> <p>Bit[7] - SFPB_TXDISABLE. '1': Disable SFPB TX. '0': Enable SFPB TX.</p> <p>Bit[6:5] - SFPA_RATESEL[1:0].SFPA RX rate selection 0: <4.25GBd1: > 4.25GBd</p> <p>Bit[4:0] - Reserved</p>

Instruction (8bits)	Instruction Description	Register Data Description
00010111	Read SFPB Control Registers	Register 11 Bit[7] - SFPB_TXDISABLE. Read the status of SFPB TXDISABLE. Bit[6:5] - SFPB_RATESEL[1:0]. Read the status of SFPB rate selection. Bit[4] - SFPB_LOS. Read the Los signal of SFPB. '1': Loss '0': Normal. Bit[3] - SFPB_FAULT. Read the Tx Fault signal of SFPB. '1': Fault '0': Normal. Bit[2] - SFPB_PRESENTn. Detect signal of SFP module in slot B. '1': no SFP module. '0': SFP module present Bit[1:0] - Reserved
00011001	Read I ² C master Register	Register 12 Bit[7] - I ² C master indication. '1': HPS is the I ² C master, '0' MAXV is the I ² C master Bit[6:0] - Reserved
00011010	Write HPS Warm reset Register	Register 13 Bit[7:6] - "00" Bit[5] - HPS_SPI_WARM_RESETn. Active low to warm reset HPS; MAX V automatically clears this bit 1us after it becomes active. Bit[4:0] - "00000"
00011011	Read HPS Warm reset Register	Register 13 Bit[7:6] - "00" Bit[5] - HPS_SPI_WARM_RESETn. Read the status of HPS SPI warm reset. Bit[4:0] - "00000"

Instruction (8bits)	Instruction Description	Register Data Description
00011100	Write HPS Warm Reset Key Register	Register 14 Bit[7:0] - key register of HPS warm reset. Value of 0xA8 allows bit5 in register13 to be recognized. Software must write a different value to this register after a valid write to bit5 in Register13.
00011101	Read HPS Warm Reset Key Register	Register 14 Value currently in HPS Warm Reset Key register.
00011110	Write PM Bus Control Register	Register 15 Bit[7] - A10PMBUSEN. '1': Enable the Arria 10 FPGA PMBUS. '0': Disable the Arria 10 FPGA PMBUS. Bit[6] - A10_PMBUSDIS_N. '1': Enable the System MAX5/HPS PMBus. '0': Disable the System MAX5/HPS PMBus. Bit[5:0] - Reserved
00011111	Read PM Bus Control Register	Register 15 Bit[7] - A10PMBUSEN. '1': The Arria 10 FPGA PMBUS is enabled. '0': The Arria 10 FPGA PMBUS is disabled. Bit[6] - A10_PMBUSDIS_N. '1': The System MAXV/HPS PMBus is enabled. '0': The System MAXV/HPS PMBus is disabled. Bit[5] - Pmbus_Altertn. '1': I ² C is normal. '0': I ² C Hangs Bit[4:0] - Reserved

Memory

This section describes the development board's memory interface support and also the signal names, types, and connectivity relative to the Arria 10 SoC. The development board has the following memory interfaces:

- DDR3/DDR4 (FPGA)
- DDR3/DDR4/QDRIV/RLDRAM3 (HPS)
- Boot Flash:
 - QSPI
 - Micro SD flash
 - NAND
- I²C EEPROM

Related Information

- [Timing Analysis](#)
- [DDR, DDR2, and DDR3 SDRAM Design Tutorials](#)

FPGA External Memory

One 72-bit memory interface connected to a HILO memory card is assigned into three I/O banks (3B, 3C and 3D). A hard memory core is assigned to this interface. The table below lists the memory interface pin assignment of DDR3, DDR4, RLDRAM3 and QDRIV interfaces.

Table 5-31: FPGA External Memory Interface Pin Assignment

BANK	Pin Number	DDR3	DDR4	RLDRAM3	QDRIV
3D	W8	DDR3 DQ36	DDR4 DQ36	RLDRAM3 DQ23	QDRIV DQB4
3D	Y8	DDR3 DQ32	DDR4 DQ32	RLDRAM3 DQ19	QDRIV DQB0
3D	Y10	DDR3 DQ37	DDR4 DQ37	RLDRAM3 DQ24	QDRIV DQB5
3D	AA9	DDR3 DQ38	DDR4 DQ38	RLDRAM3 DQ25	QDRIV DQB6
3D	AB11	DDR3 DQ39	DDR4 DQ39	RLDRAM3 DQ26	QDRIV QKB_N0
3D	AA10	DDR3 DM4	DDR4 LDM_n2	RLDRAM3 DQ18	QDRIV DINVB0
3D	AA8	DDR3 DQSn4	DQSL_n2	RLDRAM3 QK2n	QDRIV DQB17
3D	AA7	DDR3 DQSp4	DQSL_p2	RLDRAM3 QK2p	QDRIV DQB16
3D	AB10	DDR3 DQB34	DDR4 DQ34	RLDRAM3 DQ21	QDRIV DQB2
3D	AB9	DDR3 DQ35	DDR4 DQ35	RLDRAM3 DQ22	QDRIV DQB3
3D	AB7	DDR3 DQ39	DDR4 DQ39	RLDRAM3 DQ26	QDRIV QKB_N0
3D	AC7				QDRIV QKB_P0
3D	Y7	DDR3 DQ41	DDR4 DQ41		QDRIV DQB8
3D	Y6	DDR3 DQ40	DDR4 DQ40		QDRIV DQB7
3D	Y5	DDR3 DQ43	DDR4 DQ43		QDRIV DQB10
3D	AA5	DDR3 DQ42	DDR4 DQ42		QDRIV DQB9
3D	AD5	DDR3 DQ46	DDR4 DQ46		QDRIV DQB13

BANK	Pin Number	DDR3	DDR4	RLDRAM3	QDRIV
3D	AD4	DDR3 DQ44	DDR4 DQ44		QDRIV DQB11
3D	AE6	DDR3 DQS_n5	DDR4 DQSU_n2	RLDRAM3 DK0n	QDRIV DKB_n0
3D	AE5	DDR3 DQs_p5	DDR4 DQSU_p2	RLDRAM3 DK0p	QDRIV DKB_p0
3D	AC6	DDR3 DQ45	DDR4 DQB45		QDRIV DQB12
3D	AD6				QDRIV DQB15
3D	AB6	DDR3 DQ47	DDR4 DQ47		QDRIV DQB14
3D	AB5	DDR3 DM5	DDR4 UDM_n2		QDRIV QVLDB0
3D	Y3	DDR3 DQ52	DDR4 DQ52	RLDRAM3 DQ5	QDRIV DQB22
3D	Y2	DDR3 DQ54	DDR4 DQ54	RLDRAM3 DQ7	QDRIV DQB24
3D	W1	DDR3 DQ49	DDR4 DQ49	RLDRAM3 DQ2	QDRIV DQB19
3D	Y1	DDR3 DQ50	DDR4 DQ50	RLDRAM3 DQ3	QDRIV DQB20
3D	AA4	DDR3 DQ51	DDR4 DQ51	RLDRAM3 DQ4	QDRIV DQB21
3D	AB4	DDR3 DQ48	DDR4 DQ48	RLDRAM3 DQ1	QDRIV DQB18
3D	AA3	DDR3 DQS_n6	DDR4 DQSL_n3	RLDRAM3 QK0n	QDRIV DQB35
3D	AA2	DDR3 DQS_p6	DDR4 DQSL_p3	RLDRAM3 QK0	QDRIV DQB34
3D	AB2	DDR3 DM6	DDR4 LDM_n3	RLDRAM3 DQ0	QDRIV DINVB1
3D	AB1	DDR3 DQ53	DDR4 DQ53	RLDRAM3 DQ6	QDRIV DQB23
3D	AC4	DDR3 DQ55	DDR4 DQ55	RLDRAM3 DQ8	QDRIV QKB_N1
3D	AC3			RLDRAM3 DM0	QDRIV QKB_P1
3D	AC1	DDR3 DM7	DDR4 UDM_n3		QDRIV QVLDB1

BANK	Pin Number	DDR3	DDR4	RLDRAM3	QDRIV
3D	AD1	DDR3 DQ63	DDR4 DQ63		QDRIV DQB32
3D	AD3	DDR3 DQ62	DDR4 DQ62		QDRIV DQB31
3D	AC2				QDRIV DQB33
3D	AF2	DDR3 DQ61	DDR4 DQ61		QDRIV DQB29
3D	AG2	DDR3 DQ60	DDR4 DQ60		QDRIV DQB28
3D	AG1	DDR3 DQSn7	DDR4 DQSU_n3		DKB_n1
3D	AH1	DDR3 DQSp7	DDR4 DQSU_p3		DKB_P1
3D	AE2	DDR3 DQ57	DDR4 DQ57		QDRIV DQB26
3D	AE1	DDR3 DQ58	DDR4 DQ58		QDRIV DQB27
3D	AE3	DDR3 DQ56	DDR4 DQ56		QDRIV DQB24
3D	AF3	DDR3 DQ59	DDR4 DQ59		QDRIV DQB28
3C	AC9	DDR3 DQ67	DDR4 DQ67		
3C	AC8	DDR3 DQ66	DDR4 DQ66		
3C	AE11	DDR3 DM8	DDR4 LDM_n4		
3C	AE10	DDR3 DQ65	DDR4 DQ65		
3C	AD9	DDR3 DQ64	DDR4 DQ64		
3C	AD8	DDR3 DQ68	DDR4 DQ68		
3C	AE8	DDR3_DQS8_n	DDR4 DQSL_n4		
3C	AF8	DDR3_DQS8_p	DDR4_DQSL_P4		
3C	AC11	DDR3 DQ69	DQ69		
3C	AD10	DDR3 DQ70	DQ70		
3C	AF10	DDR3 DQ71	DQ71		
3C	AF9		DDR4 ALERTn	RLDRAM3 Csn3	QDRIV A22
3C	AG4	DDR3 BA2	DDR4 BG0	RLDRAM3 BA2	QDRIV A21
3C	AH4	DDR3 BA1	DDR4 BA1	RLDRAM3 BA1	QDRIV A20
3C	AF5	DDR3 BA0	DDR4 BA0	RLDRAM3 BA0	QDRIV A19
3C	AF4	CASn	DDR4 A17	RLDRAM3 A17	QDRIV A18

BANK	Pin Number	DDR3	DDR4	RLDRAM3	QDRIV
3C	AE7	RASn	DDR4 A16	RLDRAM3 A18	QDRIV A17
3C	AF7	DDR3 A15	DDR4 A15	RLDRAM3 A15	QDRIV A16
3C	AH3	DDR3 A14	DDR4 A14	RLDRAM3 A14	QDRIV A15
3C	AJ3	DDR3 A13	DDR4 A13	RLDRAM3 A13	QDRIV A14
3C	AG7	DDR3 A12	DDR4 A12	RLDRAM3 A12	QDRIV A13
3C	AH7	240-Ohm Reference resistor			
3C	AG6	133MHz Reference clock			
3C	AG5	133MHz Reference clock			
3C	AH6	DDR3 A11	DDR4 A11	RLDRAM3 A11	QDRIV A12
3C	AJ5	DDR3 A10	DDR4 A10	RLDRAM3 A10	QDRIV A11
3C	AJ4	DDR3 A9	DDR4 A9	RLDRAM3 A9	QDRIV A10
3C	AK3	DDR3 A8	DDR4 A8	RLDRAM3 A8	QDRIV A9
3C	AJ6	DDR3 A7	DDR4 A7	RLDRAM3 A7	QDRIV A8
3C	AK6	DDR3 A6	DDR4 A6	RLDRAM3 A6	QDRIV A7
3C	AK5	DDR3 A5	DDR4 A5	RLDRAM3 A5	QDRIV A6
3C	AL5	DDR3 A4	DDR4 A4	RLDRAM3 A4	QDRIV A5
3C	AL4	DDR3 A3	DDR4 A3	RLDRAM3 A3	QDRIV A4
3C	AL3	DDR3 A2	DDR4 A2	RLDRAM3 A2	QDRIV A3
3C	AM4	DDR3 A1	DDR4 A1	RLDRAM3 A1	QDRIV A2
3C	AN3	DDR3 A0	DDR4 A0	RLDRAM3 A0	QDRIV A1
3C	AH2		DDR4 PAR	RLDRAM3 REFn	QDRIV A0
3C	AJ1		DDR4 Csn1	RLDRAM3 Csn2	QDRIV AINV
3C	AK2	DDR3 CLKn	DDR4 CLKn	RLDRAM3 CLKn	QDRIV CLKn
3C	AK1	DDR3 CLKp	DDR4 CLKp	RLDRAM3 CLKp	QDRIV CLKp
3C	AN1	DDR3 CEK1	DDR4 CEK1	RLDRAM3 Wen	QDRIV RWBn
3C	AM1	DDR3 CEK0	DDR4 CEK0	RLDRAM3 A20	QDRIV RWA _n

BANK	Pin Number	DDR3	DDR4	RLDRAM3	QDRIV
3C	AR2	DDR3 ODT1	DDR4 ODT1	RLDRAM3 A19	QDRIV LDBn
3C	AR1	DDR3 ODT0	DDR4 ODT0	RLDRAM3 A18	QDRIV LDBn
3C	AL2	DDR3 Csn1	DDR4 Actn	RLDRAM3 CSn1	QDRIV LDBn
3C	AM2	DDR3 Csn0	DDR4 Csn0	RLDRAM3 CSn0	QDRIV LDBn
3C	AN2	DDR3 resetn	DDR4 resetn	RLDRAM3 resetn	QDRIV resetn
3C	AP1	DDR3 Wen	DDR4 BG1	RLDRAM3 BA3	QDRIV CFGn
3B	AH8	DDR3 DM0	DDR4 LDM-N0		QDRIV DINVA0
3B	AJ8	DDR3 DQ6	DDR4 DQ6		QDRIV DQA6
3B	AH9	DDR3 DQ2	DDR4 DQ2		QDRIV DQA2
3B	AJ9	DDR3 DQ1	DDR4 DQ1		QDRIV DQA1
3B	AF12	DDR3 DQ3	DDR4 DQ3		QDRIV DQA3
3B	AG12	DDR3 DQ0	DDR4 DQ0		QDRIV DQA0
3B	AG10	DDR3 DQSn0	DDR4 DQSn0		QDRIV DQA17
3B	AG9	DDR3 DQSp0	DDR4 DQSp0		QDRIV DQA16
3B	AG11	DDR3 DQ5	DDR4 DQ5		QDRIV DQA5
3B	AH11	DDR3 DQ4	DDR4 DQ4		QDRIV DQA4
3B	AJ11	DDR3 DQ7	DDR4 DQ7		QDRIV QKA_N0
3B	AJ10				QDRIV QKA_P0
3B	AK7	DDR3 DQ13	DDR4 DQ13	RLDRAM3 DQ14	QDRIV DQA12
3B	AL7	DDR3 DQ15	DDR4 DQ15	RLDRAM3 DQ16	QDRIV DQA14

BANK	Pin Number	DDR3	DDR4	RLDRAM3	QDRIV
3B	AM6	DDR3 DM1	DDR4 UDM_n0		QDRIV QVLDA0
3B	AN6	DDR3 DQ12	DDR4 DQ12	RLDRAM3 DQ13	QDRIV DQA11
3B	AK8	DDR3 DQ8	DDR4 DQ8	RLDRAM3 DQ9	QDRIV DQA8
3B	AL8	DDR3 DQ9	DDR4 DQ9	RLDRAM3 DQ10	QDRIV DQA9
3B	AM7	DDR3 DQS_n1	DDR4 DQSU_n0	RLDRAM3 QK1n	DKAn0
3B	AN7	DDR3 DQS_p1	DDR4 DQSU_p0	RLDRAM3 QK1p	DKAP0
3B	AM9	DDR3 DQ14	DDR4 DQ14	RLDRAM3 DQ15	QDRIV DQA13
3B	AN8			RLDRAM3 DQ17	QDRIV DQA15
3B	AK10	DDR3 DQ10	DDR4 DQ10	RLDRAM3 DQ11	QDRIV DQA9
3B	AL9	DDR3 DQ11	DDR4 DQ11	RLDRAM3 DQ12	QDRIV DQA110
3B	AM5	DDR3 DM2	DDR4 LDM_n1	RLDRAM3 DQ13	QDRIV DINVA1
3B	AN4	DDR3 DQ20	DDR4 DQ20		QDRIV DQA22
3B	W8	DDR3 DQ19	DDR4 DQ19	RLDRAM3 QVLD1	QDRIV DQA21
3B	Y8	DDR3 DQ16	DDR4 DQ16		QDRIV DQA18
3B	Y10	DDR3 DQ22	DDR4 DQ22		QDRIV DQA24
3B	AA9	DDR3 DQ18	DDR4 DQ18		QDRIV DQA20
3B	AB11	DDR3 DQSn2	DDR4 DQSLn1	RLDRAM3 DK1n	QDRIV DQA35
3B	AA10	DDR3 DQSp2	DDR4 DQSLp1	RLDRAM3 DK1p	QDRIV DQA34
3B	AA8	DDR3 DQ17	DDR4 DQ17		QDRIV DQA19
3B	AA7	DDR3 DQ21	DDR4 DQ21		QDRIV DQA23

BANK	Pin Number	DDR3	DDR4	RLDRAM3	QDRIV
3B	AB10	DDR3 DQ23	DDR4 DQ23		QDRIV QKA_n1
3B	AB9				QDRIV QKA_p1
3B	AB7	DDR3 DQ31	DDR4 DQ31	RLDRAM3 DQ34	QDRIV DQA32
3B	AC7	DDR3 DM3	DDR4 UDM_n1		QDRIV QVLDA1
3B	Y7	DDR3 DQ30	DDR4 DQ30	RLDRAM3 DQ33	QDRIV DQA31
3B	Y6	DDR3 DQ29	DDR4 DQ29	RLDRAM3 DQ32	QDRIV DQA30
3B	Y5	DDR3 DQ24	DDR4 DQ24	RLDRAM3 DQ27	QDRIV DQA25
3B	AA5	DDR3 DQ27	DDR4 DQ27	RLDRAM3 DQ30	QDRIV DQA28
3B	AD5	DDR3 DQS3n	DDR4 DQSU_n1	RLDRAM3 QK3n	QDRIV DKA_n1
3B	AD4	DDR3 DQS3p	DDR4 DQSU_p1	RLDRAM3 QK3n	QDRIV DKA_p1
3B	AE6			RLDRAM3 DQ35	QDRIV DQA33
3B	AE5	DDR3 DQ26	DDR4 DQ26	RLDRAM3 DQ29	QDRIV DQA27
3B	AC6	DDR3 DQ25	DDR4 DQ25	RLDRAM3 DQ28	QDRIV DQA26
3B	AD6	DDR3 DQ28	DDR4 DQ28	RLDRAM3 DQ31	QDRIV DQA29

HPS External Memory

A 40-bit HPS DDR3/4 memory interface (32-bit data and 8-bit ECC data) assigned to FPGA 2K and 2J I/O banks is connected to a HILO memory daughtercard.

Table 5-32: Bank 2K and 2J I/O Pin Assignments for DDR3 and DDR4 Interface

BANK	Pin Number	DDR3 Interface	DDR4 Interface
2K	P25	DM4	DM4
2K	N25	DQ4 bit	DQ4 bit
2K	L26	DQ4 bit	DQ4 bit
2K	K26	DQ4 bit	DQ bit
2K	M25	DQ4 bit	DQ bit
2K	L25	DQ4 bit	DQ bit
2K	L24	DQS4_n	DQS4_n
2K	K25	DQS4_p	DQS4_P
2K	N24	DQ4 bit	DQ bit
2K	M24	DQ4 bit	DQ bit
2K	J25	DQ4 bit	DQ bit
2K	J26		
2K	J24	BA2	BG0
2K	H24	BA1	BA1
2K	E25	BA0	BA0
2K	D25	CASn	A17
2K	F23	RASn	A16
2K	F24	A15	A15
2K	G25	A14	A14
2K	G26	A13	A13
2K	F26	A12	A12
2K	E26	240-Ohm reference resistor	240-Ohm reference resistor
2K	G24	133MHz DDR reference clock	133MHz DDR reference clock
2K	F25	133MHz DDR reference clock	133MHz DDR reference clock
2K	D24	A11	A11
2K	C24	A10	A10
2K	E23	A9	A9

BANK	Pin Number	DDR3 Interface	DDR4 Interface
2K	D23	A8	A8
2K	C23	A7	A7
2K	B22	A6	A6
2K	B24	A5	A5
2K	C25	A4	A4
2K	C21	A3	A3
2K	C22	A2	A2
2K	C26	A1	A1
2K	B26	A0	A0
2K	A18	No use	PAR
2K	A17	No use	CSN1
2K	B19	DDR3 interface clock	DDR4 interface clock
2K	B20	DDR3 interface clock	DDR4 interface clock
2K	A23	CKe1	CKe1
2K	A24	CKe0	CKe0
2K	A25	ODT1	ODT1
2K	A26	ODT0	ODT0
2K	B21	CSn1	ACTn
2K	A22	CSn0	CSn0
2K	A19	Resetn	Resetn
2K	A20	Wen	BG1
2J	AV26	DM3	DM3
2J	AV27	DQ3 bit	DQ3 bit
2J	AU27	DQ3 bit	DQ3 bit
2J	AU28	DQ3 bit	DQ3 bit
2J	AV28	DQ3 bit	DQ3 bit
2J	AW28	DQ3 bit	DQ3 bit
2J	AW25	DQS 3n	DQS_n3
2J	AW26	DQS 3p	DQS_p3
2J	AV24	DQ3 bit	DQ3 bit
2J	AW24	DQ3 bit	DQ3 bit
2J	AV23	DQ3 bit	DQ3 bit
2J	AW23		
2J	AU25	DM2	DM2

BANK	Pin Number	DDR3 Interface	DDR4 Interface
2J	AU26	DQ2 bit	DQ2 bit
2J	AR26	DQ2 bit	DQ2 bit
2J	AT26	DQ2 bit	DQ2 bit
2J	AT23	DQ2 bit	DQ2 bit
2J	AU24	DQ2 bit	DQ2 bit
2J	AT24	DQS2n	DQS_n2
2J	AT25	DQS2p	DQS_p2
2J	AP25	DQ2 bit	DQ2 bit
2J	AR25	DQ2 bit	DQ2 bit
2J	AP23	DQ2 bit	DQ2 bit
2J	AP24		
2J	AN26	DM1	DM1
2J	AP26	DQ1 bit	DQ1 bit
2J	AN23	DQ1 bit	DQ1 bit
2J	AN24	DQ1 bit	DQ1 bit
2J	AK26	DQ1 bit	DQ1 bit
2J	AL26	DQ1 bit	DQ1 bit
2J	AL25	DQSn1	DQS1n
2J	AM25	DQSp1	DQS1p
2J	AK23	DQ1 bit	DQ1 bit
2J	AL23	DQ1 bit	DQ1 bit
2J	AM24	DQ1 bit	DQ1 bit
2J	AL24		
2J	AH25	DM0	DM0
2J	AJ26	DQ0 bit	DQ0 bit
2J	AH23	DQ0 bit	DQ0 bit
2J	AH24	DQ0 bit	DQ0 bit
2J	AJ23	DQ0 bit	DQ0 bit
2J	AJ24	DQ0 bit	DQ0 bit
2J	AJ25	DQSn0	DQS0n
2J	AK25	DQSp0	DQS0p
2J	AF25	DQ0 bit	DQ0 bit
2J	AG25	DQ0 bit	DQ0 bit
2J	AF24	DQ0 bit	DQ0 bit

BANK	Pin Number	DDR3 Interface	DDR4 Interface
2J	AG24	No use	Alertn

HPS Boot Flash Interface

The HPS includes dedicated I/O. The dedicated I/O [17:4] are used to connect the following boot flash daughtercards:

- NAND Flash (x8) card: 128MB
- QSPI Flash card: 128MB
- SD Micro flash card: 4GB

Table 5-33: Dedicated I/O Pin Assignments

BANK	Pin Number	NF1.0 Interface	QSPI Interface	SDMMC Interface
Dedicated	E16	NAND_ADQ0	QSPI_CLK	SDMMC_DATA0
Dedicated	H16	NAND_ADQ1	QSPI_ID0	SDMMC_CMD
Dedicated	K16	NAND_Wen	QSPI_SS0	SDMMC_CCLK
Dedicated	G16	NAND_REn	QSPI_IO1	SDMMC_DATA1
Dedicated	H17	NAND ADQ2	QSPI_IO2_WPn	SDMMC_DATA2
Dedicated	F15	NAND ADQ3	QSPI_IO3_HOLD	SDMMC_DATA3
Dedicated	L17	NAND_CLE	No use	SDMMC_PWR
Dedicated	N19	NAND_ALE	No use	No use
Dedicated	M19	NAND_RB	No use	SDMMC_DATA4
Dedicated	E15	NAND_Cen	No use	SDMMC_DATA5
Dedicated	J16	NAND AD4	No use	SDMMC_DATA6
Dedicated	L18	NAND AD5	No use	SDMMC_DATA7
Dedicated	M17	NAND AD6	No use	No use
Dedicated	K17	NAND AD7	No use	No use

The flash mode is selected by the `BOOTSEL` bits defined in the flash daughtercard. `BOOTSEL` values are 0x02, 0x04 and 0x06.





I²C EEPROM

This board includes a 32 Kb EEPROM device. This device has a 2-wire I²C serial interface bus and is organized as four blocks of 4K x 8-bit memory. The main function of the device is for EtherCAT IP usage, but it can be used for other storage purposes as well.

Daughtercards

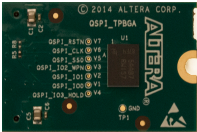
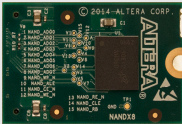
Altera Corporation and its partners offer a variety of application-specific daughtercards. You can use these daughtercards to expand the functionality of the Arria 10 SoC development board. Reference designs and application-specific software accompany many of the daughtercards, further facilitating the design process. All daughtercards are available for purchase on Altera.com.

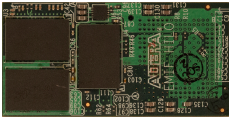
Table 5-34: Arria 10 SoC Development Board Daughtercards

Daughtercard	Daughtercard Image	Memory Component	Part Number
Boot Flash Daughtercards			
Micro SD Boot Flash Card		Kingston MBLY10G2/4GB	QSHDC-MSD-A
QSPI Boot Flash Card		Micron MT25QU01GBBA8E12-0SIT	QSHDC-QSPI-A
NAND Boot Flash Card		Micron MT29F1G08ABBEAH4	QSHDC-NAND-A
HILO memory Daughtercards			
RLDRAM3		Micron MT44K16M36RB-093E	HLDC-RLDRAM3-A
DDR3		Micron MT41K512M16TNA-107:E	HLDC-DDR3-A
DDR4		Micron EDY4016AABG-DR-F	HLDC-DDR4-A

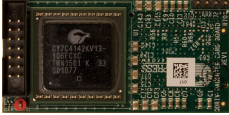
Daughtercard	Daughtercard Image	Memory Component	Part Number
QDRIV		Cypress CY7C4142KV13-106FCXC	HLDC-QDRIV-A

Related Information[All Daughtercards](#)

Board Power Supply

This section describes the Arria 10 SoC development board's power supply. A laptop style DC power supply is provided with the development kit. Use only the supplied power supply. The power supply has an auto-sensing input voltage range of 100 ~ 240 VAC and outputs 12 VDC power at 16 A to the development board. The 12 VDC input power is then stepped down to various power rails used by the board components.

An on-board multi-channel analog-to-digital converter (ADC) measures both the voltage and current for several specific board rails. The power utilization is displayed on a graphical user interface (GUI) that can graph power consumption versus time.

Power Distribution System

The following figure below shows the power distribution system on the A10 SoC development board.

Figure 5-15: Arria 10 SoC Development Kit Power Distribution Network Diagram

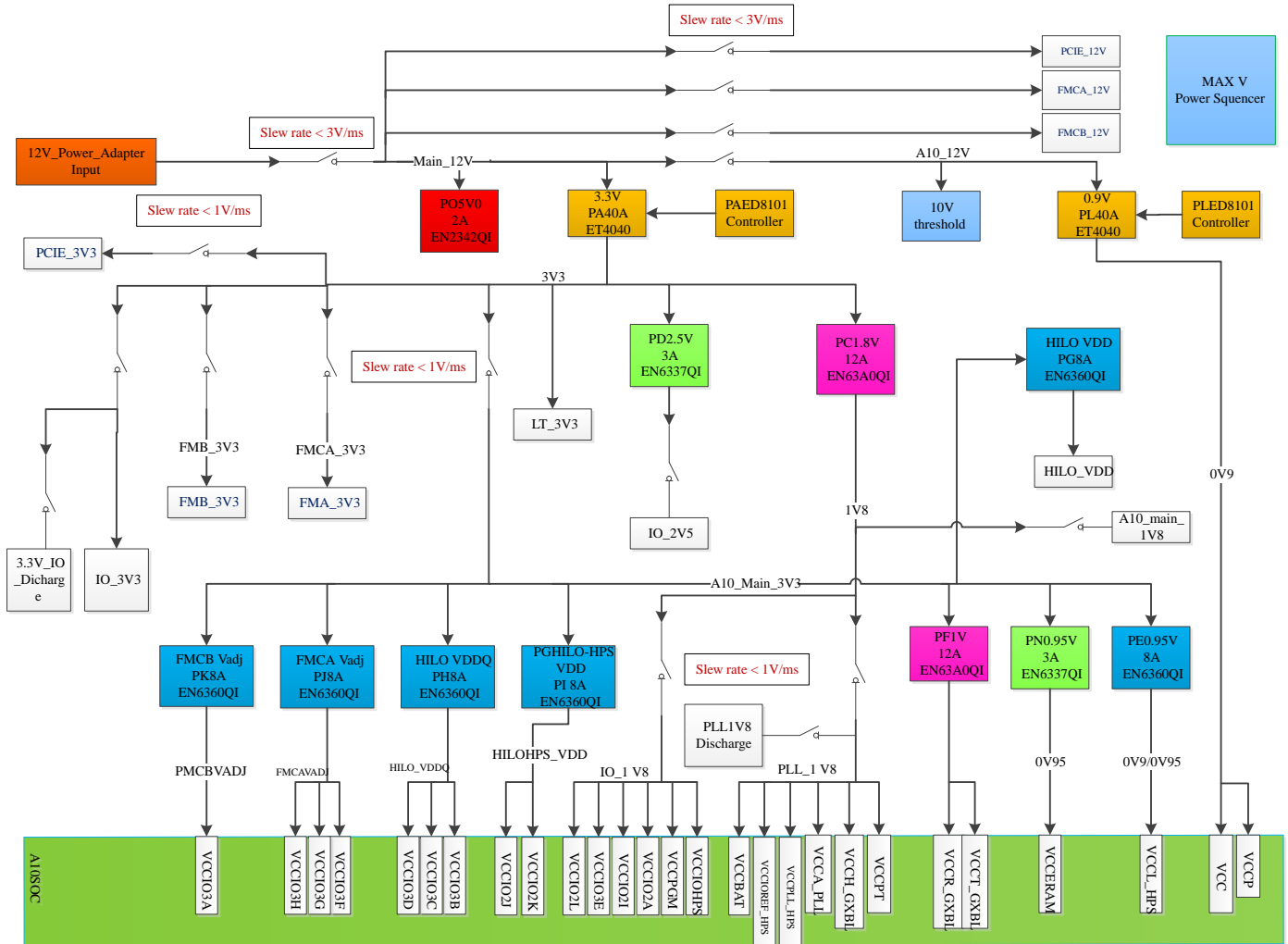

Power Measurement

You can insert a DC1613A Linear Dongle into the J28 connector to collect voltage, current, and wattage. 24-bit differential ADC devices are used to measure the on-board power voltage, current, and wattage. Precision sense resistors split the ADC devices and rails from the primary supply plane for the ADC to measure voltage and current. An I²C bus connects these ADC devices to the MAX V CPLD EPM2210 System Controller as well as the Arria 10 Soc FPGA.

2016.03.01

UG-20004



Subscribe



Send Feedback

Board & User Guide Revision History

Table A-1: Arria 10 SoC Development Kit User Guide Revision History

Date	Version	Changes
March 2016	2016.03.01	Updated "Daughterboards" section.
February 2016	2016.02.05	RevB release. Updates: <ul style="list-style-type: none"> • Figure: Overview of the Development Board Features • Figure: Default Switch and Jumper Settings • Table: SW1 Factory Default Settings • (New) Table: SW4 DIP Switch Settings • Table: SW1 GUI Mode • FMC section: Added schematic signal names to all tables • BTS images updated • FPGA-I/O MAX V Interface section and sub sections
October 2015	2015.10.	Sections updated: <ul style="list-style-type: none"> • Preparing the Board
September 2015	2015.09.04	Early access RevA.
August 2015	2015.08.14	Preliminary draft.

© 2016 Altera Corporation. All rights reserved. ALTERA, ARRIA, CYCLONE, ENPIRION, MAX, MEGACORE, NIOS, QUARTUS and STRATIX words and logos are trademarks of Altera Corporation and registered in the U.S. Patent and Trademark Office and in other countries. All other words and logos identified as trademarks or service marks are the property of their respective holders as described at www.altera.com/common/legal.html. Altera warrants performance of its semiconductor products to current specifications in accordance with Altera's standard warranty, but reserves the right to make changes to any products and services at any time without notice. Altera assumes no responsibility or liability arising out of the application or use of any information, product, or service described herein except as expressly agreed to in writing by Altera. Altera customers are advised to obtain the latest version of device specifications before relying on any published information and before placing orders for products or services.

ISO
9001:2008
Registered

ALTERA
now part of Intel