

R0E424270MCU00

User's Manual

E100 Emulator MCU Unit for H8S/2400 Series

All information contained in these materials, including products and product specifications, represents information on the product at the time of publication and is subject to change by Renesas Electronics Corporation without notice. Please review the latest information published by Renesas Electronics Corporation through various means, including the Renesas Electronics Corporation website (<http://www.renesas.com>).

Notice

1. Descriptions of circuits, software and other related information in this document are provided only to illustrate the operation of semiconductor products and application examples. You are fully responsible for the incorporation or any other use of the circuits, software, and information in the design of your product or system. Renesas Electronics disclaims any and all liability for any losses and damages incurred by you or third parties arising from the use of these circuits, software, or information.
2. Renesas Electronics hereby expressly disclaims any warranties against and liability for infringement or any other claims involving patents, copyrights, or other intellectual property rights of third parties, by or arising from the use of Renesas Electronics products or technical information described in this document, including but not limited to, the product data, drawings, charts, programs, algorithms, and application examples.
3. No license, express, implied or otherwise, is granted hereby under any patents, copyrights or other intellectual property rights of Renesas Electronics or others.
4. You shall be responsible for determining what licenses are required from any third parties, and obtaining such licenses for the lawful import, export, manufacture, sales, utilization, distribution or other disposal of any products incorporating Renesas Electronics products, if required.
5. You shall not alter, modify, copy, or reverse engineer any Renesas Electronics product, whether in whole or in part. Renesas Electronics disclaims any and all liability for any losses or damages incurred by you or third parties arising from such alteration, modification, copying or reverse engineering.
6. Renesas Electronics products are classified according to the following two quality grades: "Standard" and "High Quality". The intended applications for each Renesas Electronics product depends on the product's quality grade, as indicated below.

"Standard": Computers; office equipment; communications equipment; test and measurement equipment; audio and visual equipment; home electronic appliances; machine tools; personal electronic equipment; industrial robots; etc.

"High Quality": Transportation equipment (automobiles, trains, ships, etc.); traffic control (traffic lights); large-scale communication equipment; key financial terminal systems; safety control equipment; etc.

Unless expressly designated as a high reliability product or a product for harsh environments in a Renesas Electronics data sheet or other Renesas Electronics document, Renesas Electronics products are not intended or authorized for use in products or systems that may pose a direct threat to human life or bodily injury (artificial life support devices or systems; surgical implantations; etc.), or may cause serious property damage (space system; undersea repeaters; nuclear power control systems; aircraft control systems; key plant systems; military equipment; etc.). Renesas Electronics disclaims any and all liability for any damages or losses incurred by you or any third parties arising from the use of any Renesas Electronics product that is inconsistent with any Renesas Electronics data sheet, user's manual or other Renesas Electronics document.

7. No semiconductor product is absolutely secure. Notwithstanding any security measures or features that may be implemented in Renesas Electronics hardware or software products, Renesas Electronics shall have absolutely no liability arising out of any vulnerability or security breach, including but not limited to any unauthorized access to or use of a Renesas Electronics product or a system that uses a Renesas Electronics product. RENESAS ELECTRONICS DOES NOT WARRANT OR GUARANTEE THAT RENESAS ELECTRONICS PRODUCTS, OR ANY SYSTEMS CREATED USING RENESAS ELECTRONICS PRODUCTS WILL BE INVULNERABLE OR FREE FROM CORRUPTION, ATTACK, VIRUSES, INTERFERENCE, HACKING, DATA LOSS OR THEFT, OR OTHER SECURITY INTRUSION ("Vulnerability Issues"). RENESAS ELECTRONICS DISCLAIMS ANY AND ALL RESPONSIBILITY OR LIABILITY ARISING FROM OR RELATED TO ANY VULNERABILITY ISSUES. FURTHERMORE, TO THE EXTENT PERMITTED BY APPLICABLE LAW, RENESAS ELECTRONICS DISCLAIMS ANY AND ALL WARRANTIES, EXPRESS OR IMPLIED, WITH RESPECT TO THIS DOCUMENT AND ANY RELATED OR ACCOMPANYING SOFTWARE OR HARDWARE, INCLUDING BUT NOT LIMITED TO THE IMPLIED WARRANTIES OF MERCHANTABILITY, OR FITNESS FOR A PARTICULAR PURPOSE.
8. When using Renesas Electronics products, refer to the latest product information (data sheets, user's manuals, application notes, "General Notes for Handling and Using Semiconductor Devices" in the reliability handbook, etc.), and ensure that usage conditions are within the ranges specified by Renesas Electronics with respect to maximum ratings, operating power supply voltage range, heat dissipation characteristics, installation, etc. Renesas Electronics disclaims any and all liability for any malfunctions, failure or accident arising out of the use of Renesas Electronics products outside of such specified ranges.
9. Although Renesas Electronics endeavors to improve the quality and reliability of Renesas Electronics products, semiconductor products have specific characteristics, such as the occurrence of failure at a certain rate and malfunctions under certain use conditions. Unless designated as a high reliability product or a product for harsh environments in a Renesas Electronics data sheet or other Renesas Electronics document, Renesas Electronics products are not subject to radiation resistance design. You are responsible for implementing safety measures to guard against the possibility of bodily injury, injury or damage caused by fire, and/or danger to the public in the event of a failure or malfunction of Renesas Electronics products, such as safety design for hardware and software, including but not limited to redundancy, fire control and malfunction prevention, appropriate treatment for aging degradation or any other appropriate measures. Because the evaluation of microcomputer software alone is very difficult and impractical, you are responsible for evaluating the safety of the final products or systems manufactured by you.
10. Please contact a Renesas Electronics sales office for details as to environmental matters such as the environmental compatibility of each Renesas Electronics product. You are responsible for carefully and sufficiently investigating applicable laws and regulations that regulate the inclusion or use of controlled substances, including without limitation, the EU RoHS Directive, and using Renesas Electronics products in compliance with all these applicable laws and regulations. Renesas Electronics disclaims any and all liability for damages or losses occurring as a result of your noncompliance with applicable laws and regulations.
11. Renesas Electronics products and technologies shall not be used for or incorporated into any products or systems whose manufacture, use, or sale is prohibited under any applicable domestic or foreign laws or regulations. You shall comply with any applicable export control laws and regulations promulgated and administered by the governments of any countries asserting jurisdiction over the parties or transactions.
12. It is the responsibility of the buyer or distributor of Renesas Electronics products, or any other party who distributes, disposes of, or otherwise sells or transfers the product to a third party, to notify such third party in advance of the contents and conditions set forth in this document.
13. This document shall not be reprinted, reproduced or duplicated in any form, in whole or in part, without prior written consent of Renesas Electronics.
14. Please contact a Renesas Electronics sales office if you have any questions regarding the information contained in this document or Renesas Electronics products.

(Note1) "Renesas Electronics" as used in this document means Renesas Electronics Corporation and also includes its directly or indirectly controlled subsidiaries.

(Note2) "Renesas Electronics product(s)" means any product developed or manufactured by or for Renesas Electronics.

(Rev.5.0-1 October 2020)

Corporate Headquarters

TOYOSU FORESIA, 3-2-24 Toyosu,
Koto-ku, Tokyo 135-0061, Japan

www.renesas.com

Trademarks

Renesas and the Renesas logo are trademarks of Renesas Electronics Corporation. All trademarks and registered trademarks are the property of their respective owners.

Contact information

For further information on a product, technology, the most up-to-date version of a document, or your nearest sales office, please visit:
www.renesas.com/contact/.

General Precautions in the Handling of Microprocessing Unit and Microcontroller Unit Products

The following usage notes are applicable to all Microprocessing unit and Microcontroller unit products from Renesas. For detailed usage notes on the products covered by this document, refer to the relevant sections of the document as well as any technical updates that have been issued for the products.

1. Precaution against Electrostatic Discharge (ESD)

A strong electrical field, when exposed to a CMOS device, can cause destruction of the gate oxide and ultimately degrade the device operation. Steps must be taken to stop the generation of static electricity as much as possible, and quickly dissipate it when it occurs. Environmental control must be adequate. When it is dry, a humidifier should be used. This is recommended to avoid using insulators that can easily build up static electricity.

Semiconductor devices must be stored and transported in an anti-static container, static shielding bag or conductive material. All test and measurement tools including work benches and floors must be grounded. The operator must also be grounded using a wrist strap. Semiconductor devices must not be touched with bare hands. Similar precautions must be taken for printed circuit boards with mounted semiconductor devices.

2. Processing at power-on

The state of the product is undefined at the time when power is supplied. The states of internal circuits in the LSI are indeterminate and the states of register settings and pins are undefined at the time when power is supplied. In a finished product where the reset signal is applied to the external reset pin, the states of pins are not guaranteed from the time when power is supplied until the reset process is completed. In a similar way, the states of pins in a product that is reset by an on-chip power-on reset function are not guaranteed from the time when power is supplied until the power reaches the level at which resetting is specified.

3. Input of signal during power-off state

Do not input signals or an I/O pull-up power supply while the device is powered off. The current injection that results from input of such a signal or I/O pull-up power supply may cause malfunction and the abnormal current that passes in the device at this time may cause degradation of internal elements. Follow the guideline for input signal during power-off state as described in your product documentation.

4. Handling of unused pins

Handle unused pins in accordance with the directions given under handling of unused pins in the manual. The input pins of CMOS products are generally in the high-impedance state. In operation with an unused pin in the open-circuit state, extra electromagnetic noise is induced in the vicinity of the LSI, an associated shoot-through current flows internally, and malfunctions occur due to the false recognition of the pin state as an input signal become possible.

5. Clock signals

After applying a reset, only release the reset line after the operating clock signal becomes stable. When switching the clock signal during program execution, wait until the target clock signal is stabilized. When the clock signal is generated with an external resonator or from an external oscillator during a reset, ensure that the reset line is only released after full stabilization of the clock signal. Additionally, when switching to a clock signal produced with an external resonator or by an external oscillator while program execution is in progress, wait until the target clock signal is stable.

6. Voltage application waveform at input pin

Waveform distortion due to input noise or a reflected wave may cause malfunction. If the input of the CMOS device stays in the area between V_{IL} (Max.) and V_{IH} (Min.) due to noise, for example, the device may malfunction. Take care to prevent chattering noise from entering the device when the input level is fixed, and also in the transition period when the input level passes through the area between V_{IL} (Max.) and V_{IH} (Min.).

7. Prohibition of access to reserved addresses

Access to reserved addresses is prohibited. The reserved addresses are provided for possible future expansion of functions. Do not access these addresses as the correct operation of the LSI is not guaranteed.

8. Differences between products

Before changing from one product to another, for example to a product with a different part number, confirm that the change will not lead to problems. The characteristics of a microprocessing unit or microcontroller unit products in the same group but having a different part number might differ in terms of internal memory capacity, layout pattern, and other factors, which can affect the ranges of electrical characteristics, such as characteristic values, operating margins, immunity to noise, and amount of radiated noise. When changing to a product with a different part number, implement a system-evaluation test for the given product.

Regulatory Compliance Notices

European Union regulatory notices

This product complies with the following EU Directives. (These directives are only valid in the European Union.)

CE Certifications:

- Electromagnetic Compatibility (EMC) Directive 2014/30/EU
EN 55032 Class A

WARNING: This is a Class A product. This equipment can cause radio frequency noise when used in the residential area. In such cases, the ser/operator of the equipment may be required to take appropriate countermeasures under his responsibility.

EN 55024

- Information for traceability
 - Authorised representative
 - Name: Renesas Electronics Corporation
 - Address: Toyosu Foresia, 3-2-24, Toyosu, Koto-ku, Tokyo 135-0061, Japan
 - Person responsible for placing on the market
 - Name: Renesas Electronics Europe GmbH
 - Address: Arcadiastrasse 10, 40472 Dusseldorf, Germany
 - Trademark and Type name
 - Trademark: Renesas
 - Product name: E100 Emulator MCU Unit
 - Type name: R0E424270MCU00

Environmental Compliance and Certifications:

- Waste Electrical and Electronic Equipment (WEEE) Directive 2012/19/EU

United States Regulatory notices on Electromagnetic compatibility

FCC Certifications (United States Only):

This equipment has been tested and found to comply with the limits for a Class A digital device, pursuant to Part 15 of the FCC Rules. These limits are designed to provide reasonable protection against harmful interference when the equipment is operated in a commercial environment. This equipment generates, uses, and can radiate radio frequency energy and, if not installed and used in accordance with the instruction manual, may cause harmful interference to radio communications. Operation of this equipment in a residential area is likely to cause harmful interference in which case the user will be required to correct the interference at his own expense.

This device complies with Part 15 of the FCC Rules. Operation is subject to the following two conditions: (1) this device may not cause harmful interference, and (2) this device must accept any interference received, including interference that may cause undesired operation.

CAUTION: Changes or modifications not expressly approved by the party responsible for compliance could void the user's authority to operate the equipment.

Preface

The R0E424270MCU00 is a full-spec emulator for MCUs of the H8S/2400 series. This user's manual mainly describes specifications of the R0E424270MCU00 and how to set it up.

All the components of the R0E424270MCU00 are listed under "1.1 Package Components" (page 18). If you have any questions about the R0E424270MCU00, contact your local distributor.

The manuals relevant to usage of the R0E424270MCU00 are listed below. You can download the latest manuals from the Renesas Tools homepage (<https://www.renesas.com/tools>).

Related manuals

Item	Manual
Accessory	R0E424270CFLE0 User's Manual
	R0E424270CFKE0 User's Manual
	R0E0144TNPFK00 User's Manual
Integrated development environment	High-performance Embedded Workshop User's Manual
Emulator debugger	R0E424270MCU00 User's Manual
C/C++ compiler and assembler	H8S, H8/300 Series C/C++ Compiler, Assembler, Optimizing Linkage Editor Compiler Package User's Manual

Important

Before using this product, be sure to read this user's manual carefully.

Keep this user's manual, and refer to it when you have questions about this product.

Emulator:

"Emulator" in this document collectively refers to the following products manufactured by Renesas Electronics Corporation.

- (1) E100 emulator main unit
- (2) MCU unit
- (3) Pitch converter board for connecting the user system

"Emulator" herein encompasses neither the customer's user system nor the host machine.

Purpose of use of the emulator:

This emulator is a device to support the development of systems that use the H8S family H8S/2400 series of Renesas 16-bit single-chip MCUs. It provides support for system development in both software and hardware.

Be sure to use this emulator correctly according to said purpose of use. Please avoid using this emulator other than for its intended purpose of use.

For those who use this emulator:

This emulator can only be used by those who have carefully read the user's manual and know how to use it.

Use of this emulator requires basic knowledge of electric circuits, logical circuits, and MCUs.

When using the emulator:

- (1) This product is a development-support unit for use in your program development and evaluation stages. When a program you have finished developing is to be incorporated in a mass-produced product, the judgment as to whether it can be put to practical use is entirely your own responsibility, and should be based on evaluation of the device on which it is installed and other experiments.
- (2) In no event shall Renesas Electronics Corporation be liable for any consequence arising from the use of this product.
- (3) Renesas Electronics Corporation strives to provide workarounds for and correct trouble with products malfunctions, with some free and some incurring charges. However, this does not necessarily mean that Renesas Electronics Corporation guarantees the provision of a workaround or correction under any circumstances.
- (4) The product covered by this document has been developed on the assumption that it will be used for program development and evaluation in laboratories. Therefore, it does not fall within the scope of applicability of the Electrical Appliance and Material Safety Law and protection against electromagnetic interference when used in Japan.
- (5) Renesas Electronics Corporation cannot predict all possible situations and possible cases of misuse that carry a potential for danger. Therefore, the warnings in this user's manual and the warning labels attached to the emulator do not necessarily cover all such possible situations and cases. The customer is responsible for correctly and safely using this emulator.
- (6) The product covered by this document has not been through the process of checking conformance with UL or other safety standards and IEC or other industry standards. This fact must be taken into account when the product is taken from Japan to some other country.

Usage restrictions:

The emulator has been developed as a means of supporting system development by users. Therefore, do not use it as an embedded device in other equipment. Also, do not use it to develop systems or equipment for use in the following fields.

- (1) Transportation and vehicular
- (2) Medical (equipment that has an involvement in human life)
- (3) Aerospace
- (4) Nuclear power control
- (5) Undersea repeaters

If you are considering the use of the emulator for one of the above purposes, please be sure to consult your local distributor.

About product changes:

We are constantly making efforts to improve the design and performance of this emulator. Therefore, the specification or design of this emulator, or this user's manual, may be changed without prior notice.

About rights:

- (1) We assume no responsibility for any damage or infringement on patent rights or any other rights arising from the use of any information, products or circuits presented in this user's manual.
- (2) The information or data in this user's manual does not implicitly or otherwise grant a license to patent rights or any other rights belonging to Renesas or to a third party.
- (3) This user's manual and this emulator are copyrighted, with all rights reserved by Renesas. This user's manual may not be copied, duplicated or reproduced, in whole or part, without prior written consent from Renesas.

About diagrams:

Some diagrams in this user's manual may differ from the objects they represent.

Precautions for Safety

Definitions of Signal Words

In both the user's manual and on the product itself, several icons are used to insure proper handling of this product and also to prevent injuries to you or other persons, or damage to your properties.

This chapter describes the precautions which should be taken in order to use this product safely and properly. Be sure to read this chapter before using this product.



This symbol represents a warning about safety. It is used to arouse caution about a potential danger that will possibly inflict an injury on persons. To avoid a possible injury or death, please be sure to observe the safety message that follows this symbol.



DANGER

DANGER indicates an imminently dangerous situation that will cause death or heavy wound unless it is avoided. However, there are no instances of such danger for the product presented in this user's manual.



WARNING

WARNING indicates a potentially dangerous situation that will cause death or heavy wound unless it is avoided.



CAUTION

CAUTION indicates a potentially dangerous situation that will cause a slight injury or a medium-degree injury unless it is avoided.

CAUTION

CAUTION with no safety warning symbols attached indicates a potentially dangerous situation that will cause property damage unless it is avoided.

IMPORTANT

This is used in operation procedures or explanatory descriptions to convey exceptional conditions or cautions to the user.

In addition to the five above, the following are also used as appropriate.

△ means WARNING or CAUTION.

Example:



CAUTION AGAINST AN ELECTRIC SHOCK

⊘ means PROHIBITION.

Example:



DISASSEMBLY PROHIBITED

● means A FORCIBLE ACTION.

Example:



UNPLUG THE POWER CABLE FROM THE RECEPTACLE.

⚠ WARNING

Warnings for AC Power Supply:



- If the attached AC power cable does not fit the receptacle, do not alter the AC power cable and do not plug it forcibly. Failure to comply may cause electric shock and/or fire.

- Do not touch the plug of the AC power cable when your hands are wet. This may cause electric shock.

- This product is connected signal ground with frame ground. If your developing product is transformless (not having isolation transformer of AC power), this may cause electric shock. Also, this may give an unreparable damage to this product and your developing one.

While developing, connect AC power of the product to commercial power through isolation transformer in order to avoid these dangers.

- If other equipment is connected to the same branch circuit, care should be taken not to overload the circuit.



- When installing this equipment, insure that a reliable ground connection is maintained.



- If you smell a strange odor, hear an unusual sound, or see smoke coming from this product, then disconnect power immediately by unplugging the AC power cable from the outlet.

Do not use this as it is because of the danger of electric shock and/or fire. In this case, contact your local distributor.

- Before setting up this emulator and connecting it to other devices, turn off power or remove a power cable to prevent injury or product damage.

Warnings to Be Taken for This Product:



- Do not disassemble or modify this product. Personal injury due to electric shock may occur if this product is disassembled and modified. Disassembling and modifying the product will void your warranty.

- Make sure nothing falls into the cooling fan on the top panel, especially liquids, metal objects, or anything combustible.

Warning for Installation:



- Do not set this product in water or areas of high humidity. Make sure that the product does not get wet. Spilling water or some other liquid into the product may cause unreparable damage.

Warning for Use Environment:



- This equipment is to be used in an environment with a maximum ambient temperature of 35°C. Care should be taken that this temperature is not exceeded.

 **CAUTION****Caution for AC Adapter:**

- The DC plug of the AC adapter has the polarity shown below.



- Use an AC adapter which complies with the safety standards of the country where it is to be used.

Cautions to Be Taken for Turning On the Power:

- Turn ON/OFF the power of the emulator and user system as simultaneously as possible.
- When turning on the power again after shutting off the power, wait about 10 seconds.

Cautions to Be Taken for Handling This Product:

- Use caution when handling the main unit. Be careful not to apply a mechanical shock.
- Do not touch the connector pins of the emulator main unit and the target MCU connector pins directly. Static electricity may damage the internal circuits.
- Do not pull this emulator by the communications interface cable or the flexible cable. And, excessive flexing or force may break conductors.
- Do not flex the flexible cable excessively. The cable may cause a break.
- Do not use inch-size screws for this equipment. The screws used in this equipment are all ISO (meter-size) type screws. When replacing screws, use same type screws as equipped before.
- Do not use tape to hold the flexible cable in place, as doing so may lead to the shielding on the surface of the cable being peeled away.

Caution to Be Taken for System Malfunctions:

- If the emulator malfunctions because of interference like external noise, shut OFF the emulator once and then reactivate it.

Contents

	Page
Preface.....	5
Important.....	6
Precautions for Safety	8
Contents.....	11
User Registration	16
Terminology	17
1. Outline.....	18
1.1 Package Components	18
1.2 Other Tool Products Required for Development	18
1.3 System Configuration	19
1.3.1 System Configuration	19
1.3.2 Names and Functions of the Emulator Parts	20
1.4 Specifications	22
1.5 Operating Environment.....	23
1.6 Specifications of the AC Adapter.....	24
2. Setup.....	25
2.1 Flowchart of Starting Up the Emulator	25
2.2 Installing the Included Software	27
2.3 Connecting the MCU Unit to and Disconnecting it from the E100 Emulator Main Unit	28
2.4 Connecting the Host Machine	29
2.5 Connecting the Emulator Power Supply.....	30
2.6 Turning ON the Power.....	31
2.6.1 Checking the Connections of the Emulator System.....	31
2.6.2 Turning the Power ON and OFF	31
2.7 Self-checking	32
2.8 Selecting the Clock Supply	33
2.8.1 Clock Source	33
2.8.2 Using an Internal Oscillator Circuit Board	34
2.8.3 Using the Oscillator Circuit on the User System	35
2.8.4 Using the Internal Generator Circuit.....	35
2.9 Connecting the User System.....	36
2.9.1 Connection to a 120-pin 0.4-mm Pitch Pad Pattern.....	37
2.9.2 Connection to a 120-pin 0.5-mm Pitch Pad Pattern.....	38
2.9.3 Connection to a 144-pin 0.5-mm Pitch Pad Pattern.....	39
3. Tutorial	40
3.1 Introduction	40
3.2 Starting the High-performance Embedded Workshop	41
3.3 Connecting the Emulator	41
3.4 Downloading the Tutorial Program.....	42
3.4.1 Downloading the Tutorial Program.....	42
3.4.2 Displaying the Source Program	43
3.5 Setting Software Breakpoints	44
3.6 Executing the Program	45
3.6.1 Resetting the CPU.....	45
3.6.2 Executing the Program.....	45
3.7 Checking Breakpoints.....	46
3.7.1 Checking Breakpoints	46
3.8 Altering Register Contents.....	47
3.9 Referring to Symbols	48
3.10 Checking Memory Contents	49
3.11 Referring to Variables.....	50
3.12 Showing Local Variables	52
3.13 Single-Stepping through a Program	52
3.13.1 Executing Step In Command	53
3.13.2 Executing the Step Out Command.....	54
3.13.3 Executing the Step Over Command.....	55
3.14 Forcibly Breaking Program Execution	56

3.15 Hardware Break Facility	57
3.15.1 Stopping a Program when It Executes the Instruction at a Specified Address	57
3.16 Stopping a Program when It Accesses Memory	58
3.17 Tracing Facility	59
3.17.1 Showing the Information Acquired in "Fill Until Stop" Tracing	60
3.17.2 Showing the Information Acquired in "Fill around TP" Tracing	63
3.17.3 Showing a History of Function Execution	65
3.17.4 Filter Facility	67
3.18 Stack Trace Facility	69
3.19 What Next?	70
4. Preparation for Debugging	71
4.1 Starting the High-performance Embedded Workshop	71
4.2 Creating a New Workspace (Toolchain Unused)	72
4.3 Creating a New Workspace (with a Toolchain in Use)	74
4.4 Opening an Existing Workspace	77
4.5 Connecting the Emulator	78
4.5.1 Connecting the Emulator	78
4.5.2 Reconnecting the Emulator	78
4.6 Disconnecting the Emulator	78
4.6.1 Disconnecting the Emulator	78
4.7 Quitting the High-performance Embedded Workshop	78
4.8 Making Debugging-Related Settings	79
4.8.1 Specifying a Module for Downloading	79
4.8.2 Setting Up Automatic Execution of Command Line Batch Files	80
5. Debugging Functions	81
5.1 Setting Up the Emulation Environment	82
5.1.1 Emulator Settings During Booting up	82
5.1.2 Setting Up the Target MCU	83
5.1.3 Setting Up the System	85
5.1.4 Setting up the Memory Map	88
5.1.5 Setting for Overwriting Blocks of the Flash ROM	89
5.1.6 Settings to Request Notification of Exceptional Events	90
5.1.7 Viewing the Progress of Boot-Up Processing	91
5.2 Downloading a Program	93
5.2.1 Downloading a Program	93
5.2.2 Viewing the Source Code	93
5.2.3 Turning Columns in All Source Files off	95
5.2.4 Turning Columns off for One Source File	95
5.2.5 Viewing Assembly Language Code	96
5.2.6 Correcting Assembly Language Code	97
5.3 Viewing Memory Data in Real Time	98
5.3.1 Viewing Memory Data in Real Time	98
5.3.2 Setting the Update Interval for RAM Monitoring	99
5.3.3 Clearing RAM Monitoring Access History	99
5.3.4 Clearing RAM Monitoring Error Detection Data	99
5.4 Viewing the Current Status	100
5.4.1 Viewing the Emulator Status	100
5.4.2 Viewing the Emulator Status in the Status Bar	101
5.5 Periodically Reading Out and Showing the Emulator Status	102
5.5.1 Periodically Reading Out and Showing the Emulator Information	102
5.5.2 Selecting the Items to Be Displayed	103
5.6 Using Software Breakpoints	104
5.6.1 Using Software Breakpoints	104
5.6.2 Adding and Removing Software Breakpoints	104
5.6.3 Enabling and Disabling Software Breakpoints	106
5.7 Using Events	108
5.7.1 Using Events	108
5.7.2 Adding Events	108
5.7.3 Removing Events	114
5.7.4 Registering Events	116
5.7.5 Creating Events for Each Instance of Usage or Reusing Events	118
5.7.6 Activating Events	119

5.8	Setting Hardware Break Conditions	120
5.8.1	Setting Hardware Break Conditions.....	120
5.8.2	Setting Hardware Breakpoints.....	120
5.8.3	Saving/Loading Hardware Break Settings.....	123
5.9	Viewing Trace Information	124
5.9.1	Viewing Trace Information	124
5.9.2	Acquiring Trace Information.....	124
5.9.3	Setting Conditions for Trace Information Acquisition.....	127
5.9.4	Selecting the Trace Mode	129
5.9.5	Setting Trace Points	131
5.9.6	Setting Extraction or Elimination Conditions.....	135
5.9.7	Selecting the Type of Trace Information to be Acquired	137
5.9.8	Viewing Trace Results	138
5.9.9	Filtering Trace Information	140
5.9.10	Searching for Trace Records.....	142
5.9.11	Saving Trace Information in Files	143
5.9.12	Loading Trace Information from Files.....	144
5.9.13	Temporarily Stopping Trace Acquisition	144
5.9.14	Restarting Trace Acquisition.....	144
5.9.15	Switching the Timestamp Display	144
5.9.16	Viewing the History of Function Execution	145
5.9.17	Viewing the History of Task Execution	146
5.10	Measuring Performance	147
5.10.1	Measuring Performance	147
5.10.2	Viewing the Results of Performance Measurement	147
5.10.3	Setting Performance Measurement Conditions.....	148
5.10.4	Starting Performance Measurement.....	150
5.10.5	Clearing Performance Measurement Conditions.....	151
5.10.6	Clearing Results of Performance Measurement.....	151
5.10.7	Maximum Time of Performance Measurement	151
5.11	Measuring Code Coverage	152
5.11.1	Measuring Code Coverage.....	152
5.11.2	Opening the Code Coverage Window	152
5.11.3	Allocating Code Coverage Memory (Hardware Resource)	153
5.11.4	Code Coverage in an Address Range	156
5.11.5	Code Coverage in a Source File.....	157
5.11.6	Showing Percentages and Graphs	158
5.11.7	Sorting Coverage Data	159
5.11.8	Searching for Nonexecuted Lines.....	160
5.11.9	Clearing Code Coverage Information	161
5.11.10	Updating Coverage Information.....	161
5.11.11	Preventing Updates to Coverage Information	161
5.11.12	Saving the Code Coverage Information in a File.....	162
5.11.13	Loading Code Coverage Information from a File.....	162
5.11.14	Modes of Loading for Coverage Information Files.....	163
5.11.15	Displaying Code Coverage Information in the Editor Window.....	165
5.12	Measuring Data Coverage	166
5.12.1	Measuring Data Coverage	166
5.12.2	Opening the Data Coverage Window	166
5.12.3	Allocating Data Coverage Memory (Hardware Resource)	167
5.12.4	Data Coverage in an Address Range.....	169
5.12.5	Data Coverage in Sections	170
5.12.6	Data Coverage in the Task Stack	171
5.12.7	Clearing Data Coverage Information	172
5.12.8	Updating Coverage Information.....	172
5.12.9	Preventing Updates to Coverage Information	172
5.12.10	Saving the Data Coverage Information in a File.....	173
5.12.11	Loading Data Coverage Information from a File.....	173
5.13	Viewing Realtime Profile Information	175
5.13.1	Viewing Realtime Profile Information.....	175
5.13.2	Selecting a Realtime Profile Measurement Mode	177
5.13.3	Measuring Function Profiles	178

5.13.4	Setting Ranges for Function Profile Measurement.....	179
5.13.5	Saving Function Profile Measurement Settings.....	180
5.13.6	Loading Function Profile Measurement Settings.....	180
5.13.7	Measuring Task Profiles	181
5.13.8	Setting Ranges for Task Profile Measurement.....	182
5.13.9	Saving Task Profile Measurement Settings.....	183
5.13.10	Loading Task Profile Measurement Settings.....	183
5.13.11	Clearing Results of Realtime Profile Measurement.....	184
5.13.12	Saving Results of Realtime Profile Measurement	184
5.13.13	Setting the Unit of Measurement	184
5.13.14	Maximum Measurement Time for Realtime Profiles.....	185
5.14	Detecting Exceptional Events	186
5.14.1	Detecting Exceptional Events	186
5.14.2	Detecting Violations of Access Protection	186
5.14.3	Setting Protection for an Area.....	188
5.14.4	Detecting Reading from a Non-initialized Area.....	192
5.14.5	Detecting Stack Access Violations	194
5.14.6	Detecting a Performance-Measurement Overflow	195
5.14.7	Detecting a Realtime Profile Overflow	195
5.14.8	Detecting a Trace Memory Overflow	196
5.14.9	Detecting Task Stack Access Violations	196
5.14.10	Setting a Task Stack Area	197
5.14.11	Detecting an OS Dispatch	200
5.15	Using the Start/Stop Function	201
5.15.1	Opening the Start/Stop Function Setting Dialog Box	201
5.15.2	Specifying the Work address	201
5.15.3	Specifying the Routine to be Executed.....	201
5.15.4	Limitations of the Start/Stop Function.....	202
5.15.5	Limitations on Statements within Specified Routines	202
5.16	Using the Trigger Output Function	203
5.16.1	Using the External Trigger Cable for Output	203
5.16.2	Opening the Trigger Output Conditions Dialog Box	204
5.16.3	Manual Setting for Output through Trigger Pins 31 to 24.....	205
5.16.4	Setting for Output through Trigger Pins 20 to 16.....	207
5.16.5	Events	208
5.17	Measuring the Execution Times in a Specific Section	208
5.17.1	Setting Trace Conditions	208
5.17.2	Acquiring Trace Data	209
5.17.3	Specifying a Section	209
5.17.4	Saving the Execution Times to a File	210
6.	Troubleshooting (Action in Case of an Error)	211
6.1	Flowchart for Remediation of Trouble	211
6.2	Error in Self-checking	212
6.3	Errors Reported in Booting-up of the Emulator	213
6.4	How to Request Support	215
7.	Hardware Specifications	216
7.1	Target MCU Specifications.....	216
7.2	Differences between the Actual MCU and the Emulator	217
7.3	Connection Diagram.....	219
7.3.1	Connection Diagram for the R0E424270MCU00.....	219
7.4	External Dimensions.....	220
7.4.1	External Dimensions of the E100 Emulator	220
7.4.2	External Dimensions of the Converter Board (R0E424270CFLE0).....	221
7.4.3	External Dimensions of the Converter Board (R0E424270CFKE0)	222
7.4.4	External Dimensions of the Converter Board (R0E0144TNPFK00)	223
7.5	Notes on Using the MCU Unit	224
8.	Maintenance and Warranty.....	229
8.1	User Registration	229
8.2	Maintenance	229
8.3	Warranty	229
8.4	Repair Provisions	229
8.5	How to Request Repairs.....	230

Revision History1

User Registration

When you install debugger software, a text file for user registration is created on your PC. Fill it in and email it to your local distributor. If you have replaced an emulator main unit or emulation probe, rewrite an emulator name and serial number in the text file you filled in earlier to register your new hardware products.

Your registered information is used for only after-sale services, and not for any other purposes. Without user registration, you will not be able to receive maintenance services such as a notification of field changes or trouble information. So be sure to carry out the user registration.

For more information about user registration, please contact your local distributor.

Terminology

Some specific words used in this user's manual are defined below.

MCU unit (R0E424270MCU00)

This means the E100 emulator for the H8S/2400 series.

Emulator system

This means an emulator system built around the MCU unit (R0E424270MCU00). The emulator system is configured with an emulator main unit (R0E001000EMU00), MCU unit (R0E424270MCU00), emulator power supply, USB cable, emulator debugger and host machine.

Integrated development environment: High-performance Embedded Workshop

This tool provides powerful support for the development of embedded applications for Renesas microcomputers. It has an emulator debugger function allowing the emulator to be controlled from the host machine via an interface. Furthermore, it permits a range of operations from editing a project to building and debugging it to be performed within the same application. In addition, it supports version management.

Emulator debugger

This means a software tool that is started up from the High-performance Embedded Workshop, and controls the MCU unit and enables debugging.

Firmware

This means a control program stored in the emulator. This analyzes the contents of communications with the emulator debugger and controls the emulator hardware. To upgrade the firmware, download the program from the emulator debugger.

Host machine

This means a personal computer used to control the emulator.

Target MCU

This means the MCU to be debugged.

User system

This means a user's application system in which the MCU to be debugged is used.

User program

This means the program to be debugged.

Evaluation MCU

This means the MCU mounted on the emulator which is operated in a dedicated mode for use with tools.

#

This symbol indicates that a signal is active-low (e.g. RESET#).

1. Outline

This chapter describes the package components, the system configuration, and the specifications of the emulator functions and operating environment.

1.1 Package Components

The R0E424270MCU00 package consists of the following items. After you have unpacked the box, check if your R0E424270MCU00 contains all of these items.

Table 1.1 Package components

Item		Quantity
R0E424270MCU00 MCU board		1
Oscillator module (16.5 MHz) mounted in the IC16 socket		1
R0E001000FLX10 flexible cable		2
R0E424270MCU00 Release Notes (English)		1
R0E424270MCU00 Release Notes (Japanese)		1
Repair Request Sheet (English)		1
Repair Request Sheet (Japanese)		1
CD-ROM	- H8S/Tiny H8S/2400 E100 Emulator Software (H8S/Tiny H8S/2400 E100 Emulator Debugger included) - User's Manual	1

* Please keep the R0E424270MCU00's packing box and cushioning materials at hand for later reuse in sending the product for repairs or for other purposes. Always use the original packing box and cushioning material when transporting the MCU unit.

* If you have any questions or are in doubt about any point regarding the packaged product, contact your local distributor.

1.2 Other Tool Products Required for Development

To proceed with the development of a program for an H8S-family H8S/2400-series MCU, the products listed below are necessary in addition to those contained in the package and listed above. Procure these products separately.

Table 1.2 Other tool products required for development

Product	Part No.
Emulator main unit E100	R0E001000EMU00
120-pin 0.4-mm pitch LQFP (PLQP0120LA-A Former code: 120P6R-A, FP-120B, FP-120BV)	R0E424270CFLE0
120-pin 0.5-mm pitch LQFP (PLQP0120KA-A)	R0E424270CFKE0
144-pin 0.5-mm pitch LQFP (PLQP0144KA-A Former code: 144P6Q-A, FP-144L, FP-144LV)	R0E0144TNPFK00

* To purchase these products, contact your local distributor.

1.3 System Configuration

1.3.1 System Configuration

Figure 1.1 shows the configuration of the emulator system.

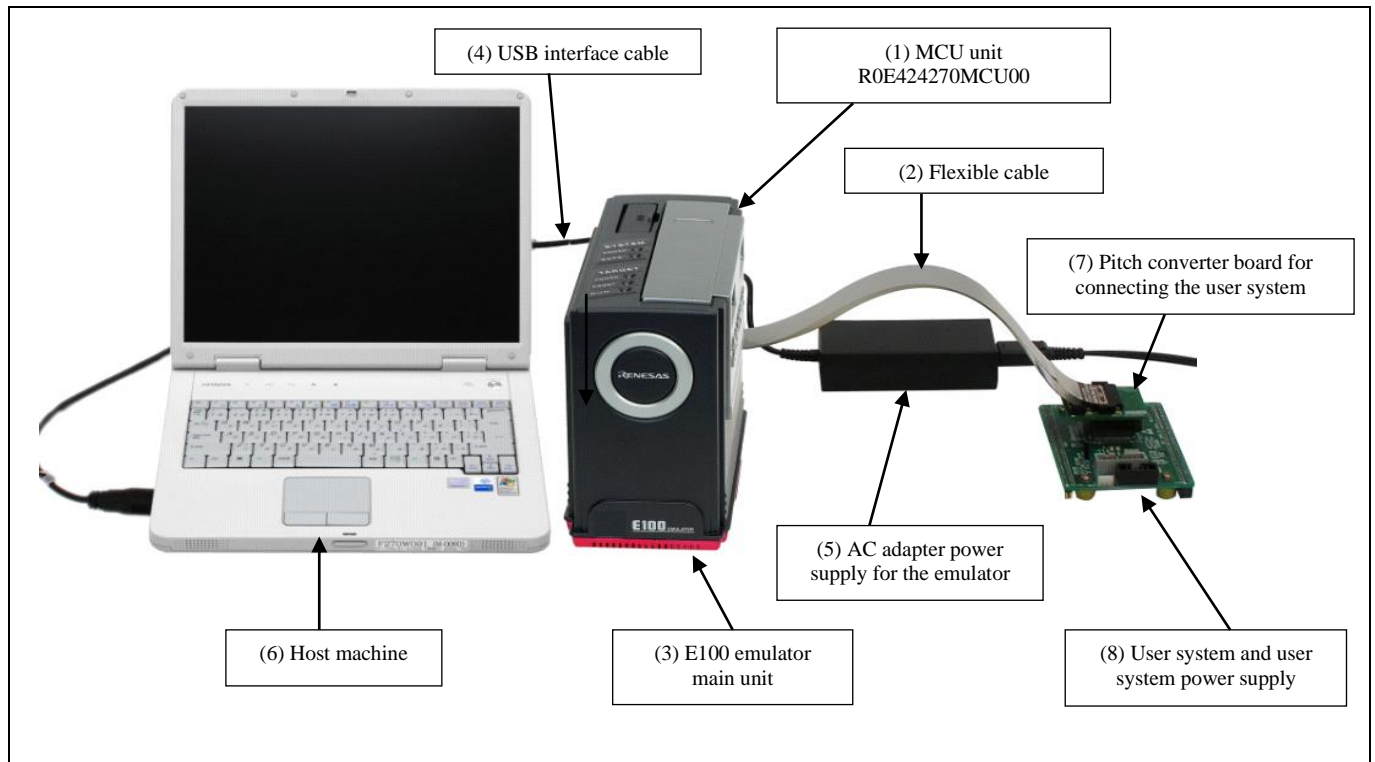

Figure 1.1 System configuration

(1) MCU unit R0E424270MCU00 (this product)

This is an MCU board for the H8S/2400-series MCUs and contains an evaluation MCU.

(2) Flexible cable R0E001000FLX10 (included)

(3) E100 emulator main unit R0E001000EMU00

This is the E100 emulator main unit.

(4) USB interface cable

This is an interface cable for the host machine and emulator.

(5) AC adapter supply for the emulator

(6) Host machine

A personal computer to control the emulator.

(7) Pitch converter board for connecting the user system (e.g. R0E424270CFLE0).

(8) User system and user system power supply

User system is your application system. This emulator can be used without the user system.

The user system power supply is power supply for the user system. This emulator cannot supply power to the user system.

Get a power supply separately.

1.3.2 Names and Functions of the Emulator Parts

Figure 1.2 shows the names of the emulator parts.



Figure 1.2 Names of the emulator parts

(1) Power switch

This is a switch to turn the emulator ON and OFF.

(2) USB cable connector

This is a connector for connecting the USB cable of the emulator.

(3) Power connector

This is a connector for connecting the DC cable of the AC power adapter of the emulator.

(4) External trigger connector

This is a connector to connect the external trigger cable of the emulator.

(5) System Status LEDs

The system status LEDs indicate the E100 emulator's power supply, operating state of firmware, etc. Table 1.3 lists the definitions of the system status LEDs.

Table 1.3 Definitions of the system status LEDs

Name	Status	Meaning
POWER	ON	Emulator system power is turned ON.
	OFF	Emulator system power is turned OFF.
SAFE	ON	Emulator system is operating normally.
	Flashing	Emulator system cannot communicate with the host machine.
	Flashing (every 2 seconds)	Self-checking is in progress.
	OFF	Emulator system is not operating normally (system status error).

(6) Target Status LEDs

The target status LEDs indicate the operating state of the target MCU and power supply of the user system. Table 1.4 lists the definitions of the target status LEDs.

Table 1.4 Definitions of the target status LEDs

Name	Status	Meaning
POWER	ON	Power is being supplied to the user system.
	OFF	Power is not being supplied to the user system.
RESET	ON	Target MCU is being reset, or reset signal of the user system is held low.
	OFF	Target MCU is not being reset.
RUN	ON	User program is being executed.
	OFF	User program has been halted.

IMPORTANT

Note on the Target Status POWER LED:

- If your MCU has two or more Vcc pins, the LED does not light up unless power is supplied to all the pins.

1.4 Specifications

Table 1.5 lists the specifications of the R0E424270MCU00.

Table 1.5 Specifications of the R0E424270MCU00

Applicable MCU	H8S-family H8S/2400-series MCUs	
Applicable MCU mode	Single-chip mode, on-chip ROM disabled extension mode, and on-chip ROM enabled extension mode	
Maximum ROM/RAM capacity	1. Internal flash ROM: 512 Kbytes 2. Internal RAM: 128 Kbytes 3. Internal data flash: 8 Kbytes	
Maximum operating frequency	33 MHz	
Power supply voltage	3.0 to 3.6 V, 4.5 to 5.5 V	
Software break	4096 points	
Hardware break	16 points (Execution address, bus detection, interrupt, external trigger signal)	
Combination, pass count	- Cumulative AND/OR/simultaneous AND/ subroutine / sequential /state transition - 255 pass counts	
Detection of exceptional events	Violation of access protection/task stack access violation/OS dispatch/reading from a non-initialized area	
Real-time tracing	192 bits × 4 M cycles (Address, data, status, CPU status, bus status, target status, task ID, timestamp, 32 external trigger inputs)	
Trace modes	Fill until stop/fill until full/fill around TP/repeat fill until stop/repeat fill until full	
Extraction/deletion of trace data	- Extracting or deleting data by specifying events or extracting the instruction that accesses the specified data - Extracting data before and after trace points	
Real-time RAM monitor	- 16,384 bytes (512 bytes × 32 blocks) - Data/last access	
Time measurement	- Execution time between program start and stop - Maximum/minimum/average execution time and number of passes through eight specified sections - Clock used to count times: 10 ns to 1.6 μs	
Coverage measurement	C0: 2 Mbytes (256 Kbytes × 8 blocks) C1: 1 Mbyte (128 Kbytes × 8 blocks)	
Profiling	1 Mbyte (128 Kbytes × 8 blocks)	
Emulation memory	4 Mbytes (1 Mbyte × 4 blocks)	
Connection to user system	120-pin 0.4 mm pitch LQFP	R0E424270CFLE0
	120-pin 0.5 mm pitch LQFP	R0E424270CFKE0
	144-pin 0.5 mm pitch LQFP	R0E0144TNPFK00
Emulator power supply	Supplied from an AC adapter (power supply voltage: 100 to 240 V, 50/60 Hz)	

1.5 Operating Environment

Make sure to use this emulator in the operating environments listed in Tables 1.6 to 1.8.

Table 1.6 Operating environmental conditions

Item	Description
Operating temperature	5 to 35°C (no condensation)
Storage temperature	-10 to 60°C (no condensation)

Table 1.7 Operating environment of the host machine (Windows® XP or Windows® 2000)

Item	Description
Host machine	IBM PC/AT compatible
OS	Windows® XP 32-bit editions [*1] [*3] Windows® 2000 [*1]
CPU	Pentium 4 running at 1.6 GHz or more recommended
Interface	USB 2.0 [*2]
Memory	768 Mbytes or larger (more than 10 times the file size of the load module) recommended
Pointing device such as mouse	Mouse or any other pointing device usable with the above OS that can be connected to the host machine
CD drive	Needed to install the emulator debugger or refer to the user's manual

Table 1.8 Operating environment of the host machine (Windows Vista®)

Item	Description
Host machine	IBM PC/AT compatible
OS	Windows Vista® 32-bit editions [*1] [*4]
CPU	Pentium 4 running at 3GHz or Core 2 Duo running at 1GHz or more recommended
Interface	USB 2.0 [*2]
Memory	1.5 Gbytes or larger (more than 10 times the file size of the load module) recommended
Pointing device such as mouse	Mouse or any other pointing device usable with the above OS that can be connected to the host machine
CD drive	Needed to install the emulator debugger or refer to the user's manual

Notes:

- *1: Windows and Windows Vista are either registered trademarks or trademarks of Microsoft Corporation in the United States and/or other countries. All other company or product names are the property of their respective owners.
- *2: Operation with all combinations of host machine, USB device and USB hub is not guaranteed for the USB interface.
- *3: The 64-bit editions of Windows® XP are not supported.
- *4: The 64-bit editions of Windows Vista® are not supported.

1.6 Specifications of the AC Adapter

The user must prepare an AC adapter and a power cable. Use an AC adapter which complies with the safety standards of the country where it is to be used. Table 1.9 lists the recommended specifications of the AC adapter.

Table 1.9 Recommended Specifications of the AC Adapter

Item	Description
AC input voltage range	AC 100 to 240 V, 50/60Hz single phase
Output power	36 W
DC output voltage, current	12.0 V, 3.0 A
DC output polarity	EIAJ TYPE IV, inner-side positive/outer-side negative

2. Setup

This chapter describes the preparation for using the MCU unit, the procedure for starting up the emulator and how to change settings.

2.1 Flowchart of Starting Up the Emulator

The procedure for starting up the emulator is shown in Figures 2.1 and 2.2. For details, refer to each section hereafter. If the emulator does not start up normally, refer to “6. Troubleshooting (Action in Case of an Error)” (page 211).

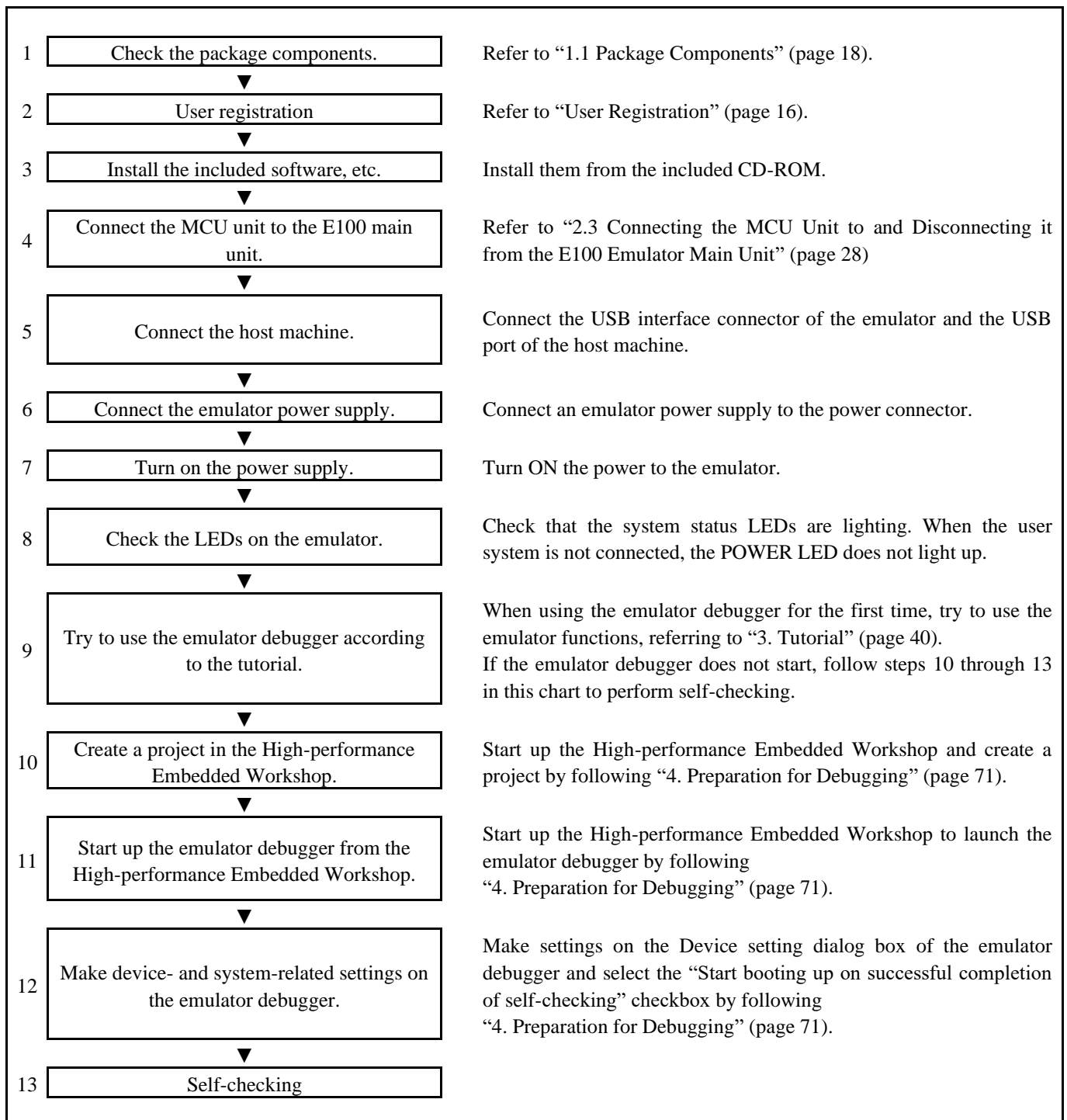

Figure 2.1 Flowchart for starting up the emulator (for the first time)

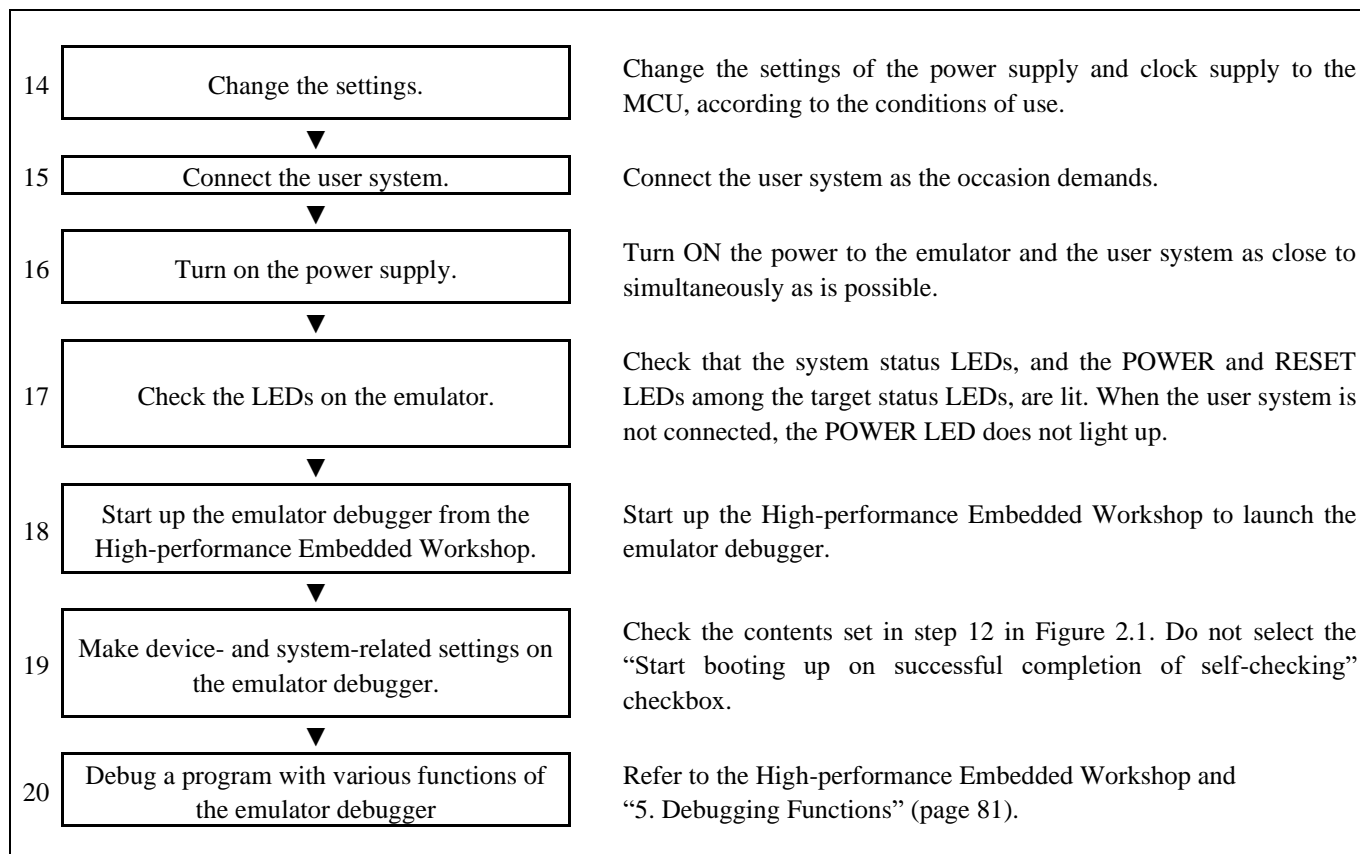

Figure 2.2 Flowchart for starting up the emulator (after self-checking)

2.2 Installing the Included Software

If you have Windows Vista®, Windows® XP or Windows® 2000 on the host machine, this installation must be executed by a user with administrator rights. Note that users without administrator rights cannot complete the installation.

Place the CD-ROM in the CD-ROM drive and follow the instructions to install the software.

2.3 Connecting the MCU Unit to and Disconnecting it from the E100 Emulator Main Unit

Figure 2.3 shows the procedure for connecting the MCU Unit to the E100 Emulator Main Unit.

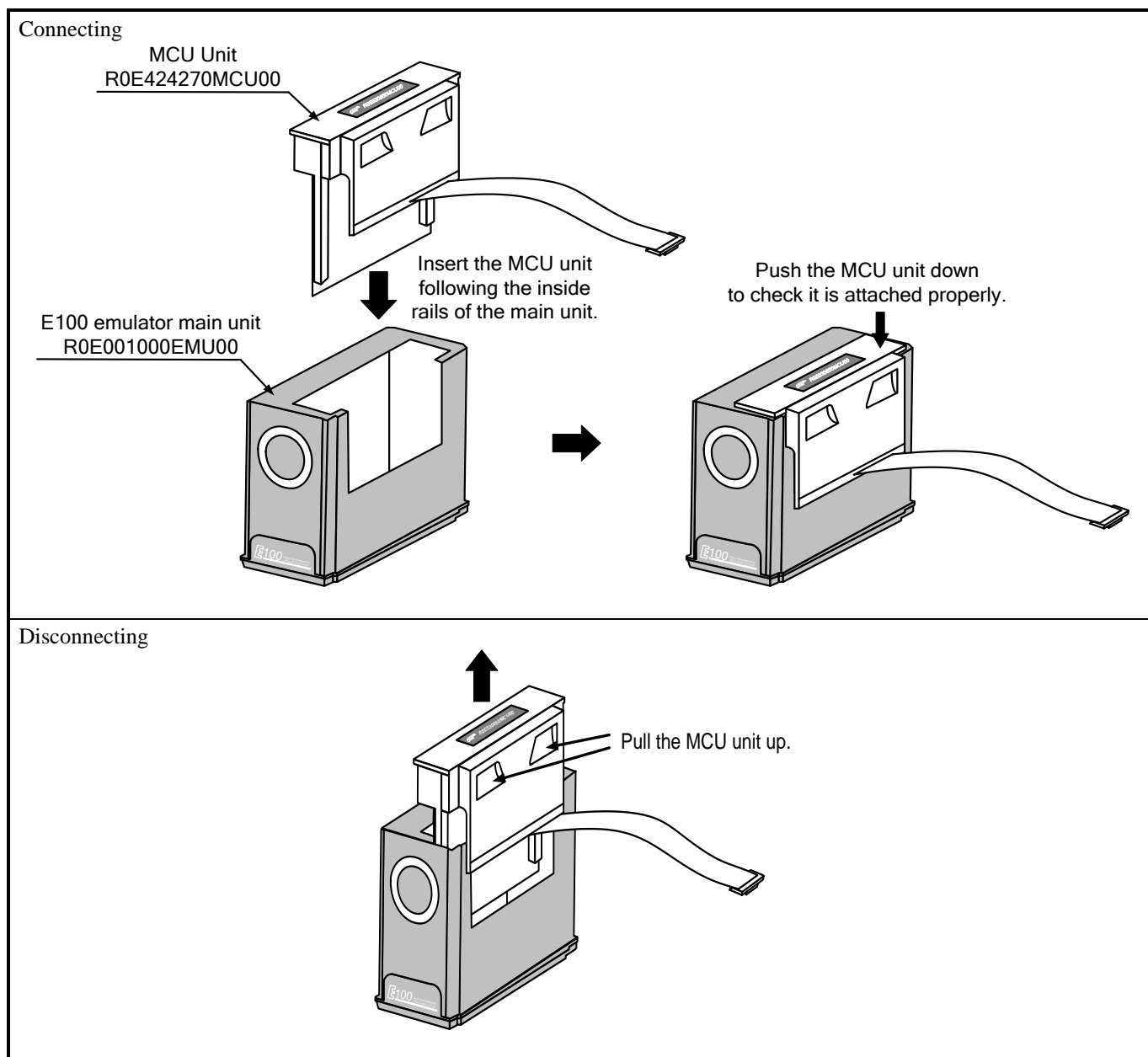

Figure 2.3 Connecting the MCU Unit to and Disconnecting it from the E100 Emulator Main Unit

⚠ CAUTION

Note on Connecting the MCU Unit to the E100 Emulator Main Unit:



- Always shut OFF the power when connecting the MCU unit to the E100 emulator main unit. Otherwise, internal circuits may be damaged.

2.4 Connecting the Host Machine

USB interface is used to connect the emulator to the host machine. The USB cable is connected to the USB cable connector of the emulator and the USB port of the host machine.

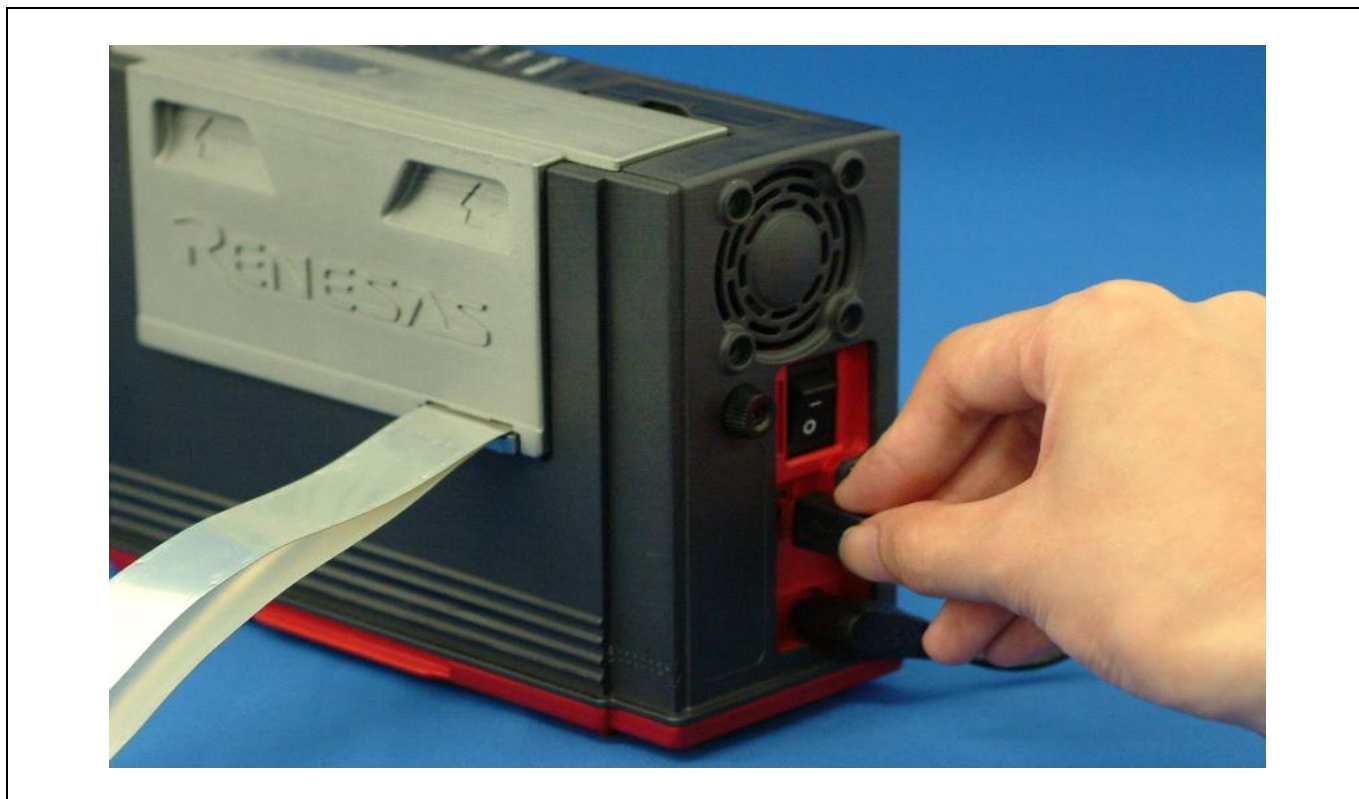

Figure 2.4 Connecting the host machine

2.5 Connecting the Emulator Power Supply

Power is supplied from an AC adapter to the emulator. The following shows how to connect the AC adapter.

- (1) Turn OFF the power to the emulator.
- (2) Connect the DC cable of the AC adapter to the emulator.
- (3) Connect the AC power cable to the AC adapter.
- (4) Connect the AC power cable to the outlet.



Figure 2.5 Connecting the emulator power supply

CAUTION

Cautions for AC Power Cable:



If the AC power cable does not fit the receptacle, do not alter the AC power cable and do not plug it forcibly. Failure to comply may cause electric shock and/or fire.
Do not touch the plug of the AC power cable when your hands are wet. This may cause electric shock.

Cautions for AC Adapter:



The DC plug of the AC adapter has the polarity shown below.



Use an AC adapter which complies with the safety standards of the country where it is to be used.

2.6 Turning ON the Power

2.6.1 Checking the Connections of the Emulator System

Before turning the power ON, check the connection of the interface cable with the host machine, emulator, and user system.

2.6.2 Turning the Power ON and OFF

- Turn power to the emulator and user system ON and OFF as close to simultaneously as is possible.
- When the SAFE LED of the system LEDs is flashing, check that the USB cable is connected to the host machine. When each of the target status LEDs is flashing, check that the MCU unit is connected.
- When turning ON the power again after shutting OFF the power, wait for about 10 seconds.

IMPORTANT

Notes on Power Supply:

- The emulator pin Vcc is connected to the user system in order to monitor user system voltage. For this reason, the emulator cannot supply power to the user system. Supply power to the user system separately.

The voltage of the user system should be as follows.

$$3.0 \text{ V} \leq V_{cc} \leq 3.6 \text{ V}, \text{ or } 4.5 \text{ V} \leq V_{cc} \leq 5.5 \text{ V}$$

- When you start the emulator without the user system, do not attach a converter board. When starting with a converter board, the MCU will be in a reset status.
- When you start the emulator without the user system, take care that metallic pieces are not touched to the connector at the head of the flexible cable.
- Do not leave either the emulator or user system powered on. The internal circuits may be damaged due to leakage current.

2.7 Self-checking

Self-checking is a test run by the emulator itself to check if its functions are operating correctly. To run the self-checking function of the emulator, follow the procedure below. While self-checking is in progress, the states of the LEDs will change as shown in Figure 2.6. In case of an ERROR, because the states of the target status LEDs will change according to the type of error, check the system status LEDs.

- (1) If the user system is connected, disconnect the converter board and the user system.
- (2) Turn on the emulator.
- (3) Launch the emulator debugger, and select the “Start booting up on successful completion of self-checking” checkbox in the Device setting dialog box.
- (4) When you click on OK, self-checking will start. If the normal result is displayed within about 90 seconds, self-checking has ended.

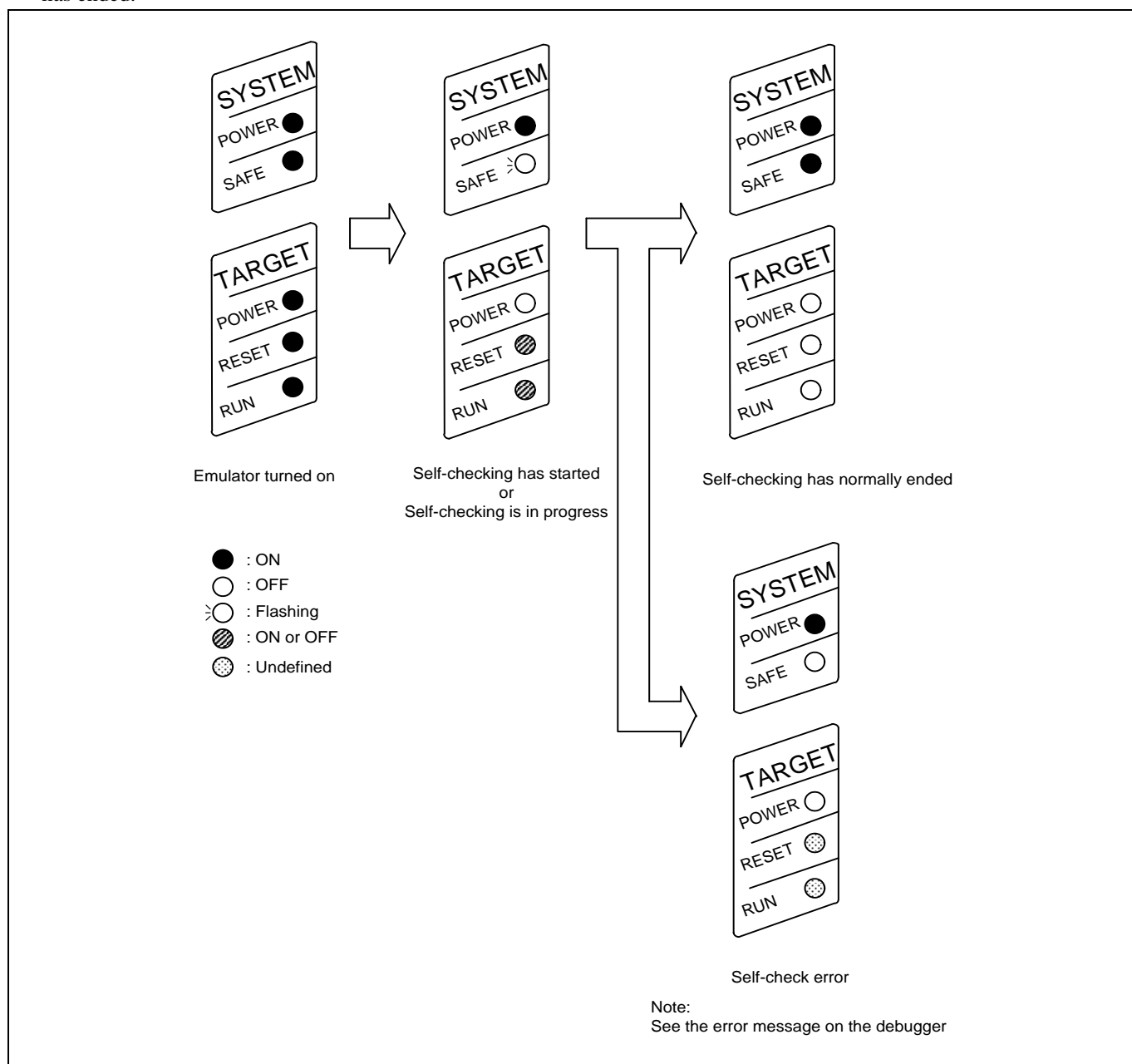

Figure 2.6 LEDs during self-checking

2.8 Selecting the Clock Supply

2.8.1 Clock Source

You can choose the source of the clock signal for supply to the evaluation MCU on the System page in the Configuration properties dialog box of the emulator debugger. Table 2.1 shows the clock sources and their default settings.

Table 2.1 Clock supply to the MCU

Clock	Clock selection in the emulator debugger	Description	Default setting
Main (EXTAL)	Emulator	Oscillator module mounted in IC16	Yes
	User	Oscillator circuit on the user system	-
	Generate	Internal generator circuit (8.0 to 20.0 MHz)	-

IMPORTANT

Note on Changing the Clock Supply:

- The clock supply can be set on the System page of the Configuration properties dialog box when starting up the emulator debugger or by input of the emulator_clock command in the Command Line window.

2.8.2 Using an Internal Oscillator Circuit Board

Kinds of Oscillator Circuit Boards

An oscillator module (16.5 MHz) is mounted in IC16 at shipment of the R0E424270MCU00. If you wish to change the frequency, replace the oscillator module.

(1) Replacing the Oscillator Module

Remove the MCU unit from the E100 emulator main unit, and replace the oscillator module in IC16 (see Figure 2.7).

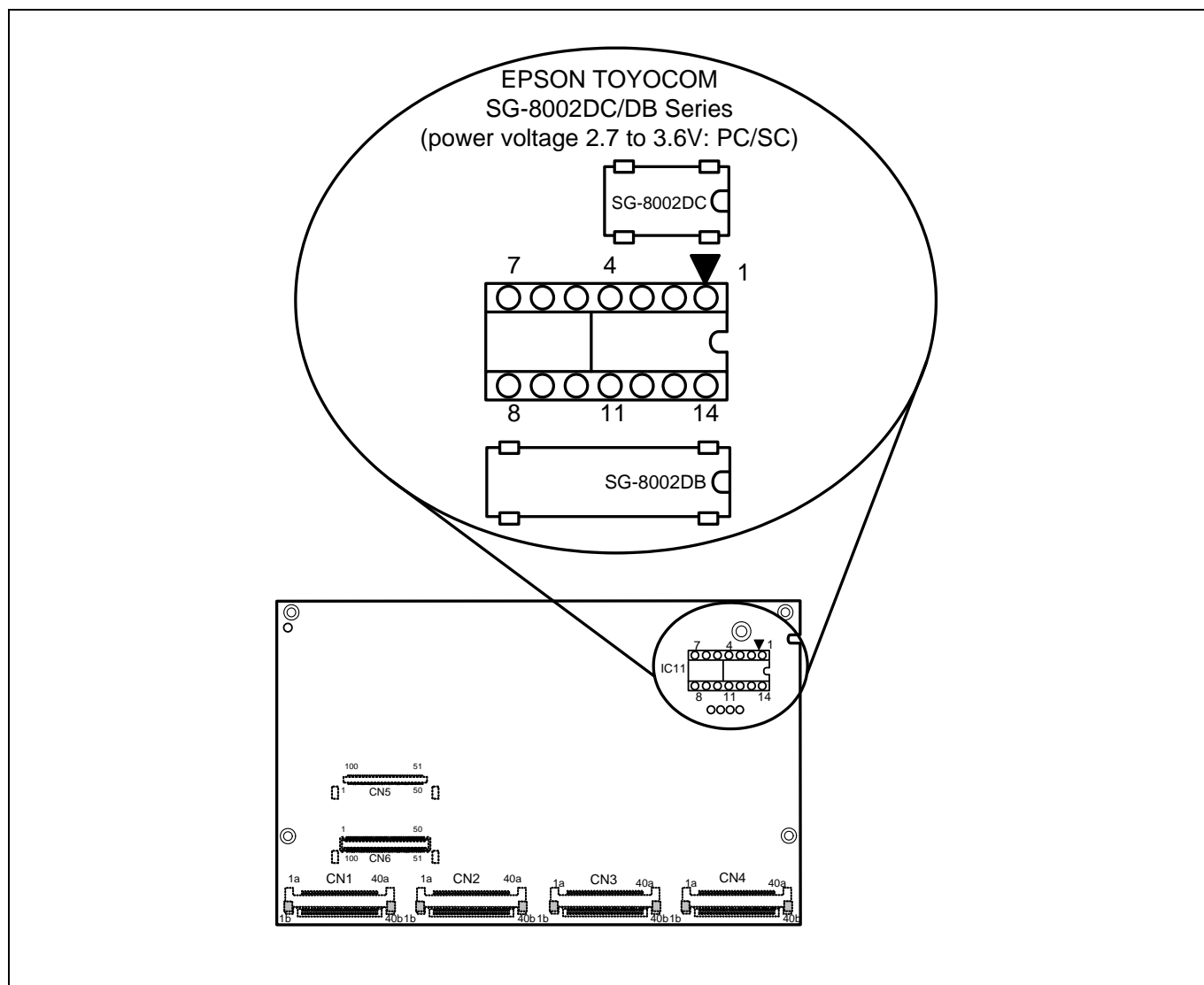

Figure 2.7 Replacing the oscillator module

CAUTION

Notes on Replacing the Oscillator Module and Oscillator Circuit Board:



- Always shut OFF power when replacing the oscillator module. Otherwise, internal circuits may be damaged.
- When replacing the oscillator module, remove it with a tool such as an IC extractor so as not to damage the board. If the board is damaged, the pattern on the board may be cut and the emulator may not be able to operate.

2.8.3 Using the Oscillator Circuit on the User System

To operate the MCU unit with an external clock source, connect an oscillator circuit to pin EXTAL of the user system as shown in Figure 2.8. The oscillator must have an output within the operating range of the evaluation MCU and a duty cycle of 50%. Pin XTAL, on the other hand, should be open-circuit. Choose "User" in the emulator debugger to use this clock source.

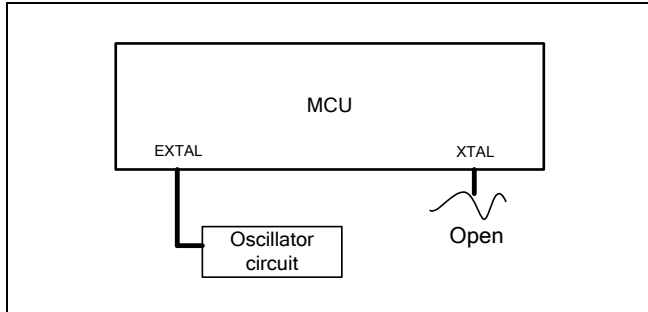

Figure 2.8 Oscillator circuit on the user system

Note that in the oscillator circuit of Figure 2.9, which is configured by connecting an oscillator between pins EXTAL and XTAL, oscillation is not possible because of the pitch-converter board between the evaluation MCU and the user system.

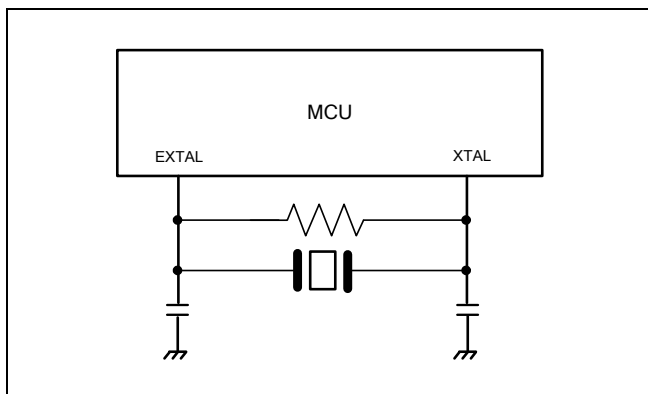

Figure 2.9 Oscillator circuit that is not usable with the emulator

2.8.4 Using the Internal Generator Circuit

The dedicated circuit in the E100 can generate a clock signal at any frequency specified in the emulator debugger, and this signal can be supplied as the main clock signal. This does not depend on the oscillator circuit board of the MCU unit or the oscillator circuit on the user system. If you want to debug programs without the user system or change the frequency temporarily, you can use the internal clock to check operation before purchasing an oscillator. If you want to use the internal generator circuit in the E100 to generate the main clock signal, choose "Generate" in the emulator debugger and specify the frequency you want.

Select frequencies between 1.0 and 99.9 MHz in 0.1-MHz steps on the E100, do not specify a value that exceeds the 20-MHz maximum input frequency for EXTAL of the MCU.

IMPORTANT

Notes on Using the Internal Generator Circuit:

- The internal generator circuit is envisaged as a provisional measure for debugging purposes. Its temperature characteristics with frequency and so on are not guaranteed.
- In final evaluation, mount an oscillator with the same frequency as that of the oscillator module or oscillator circuit (internal clock).

2.9 Connecting the User System

Figure 2.10 shows how to connect the MCU unit to your system.

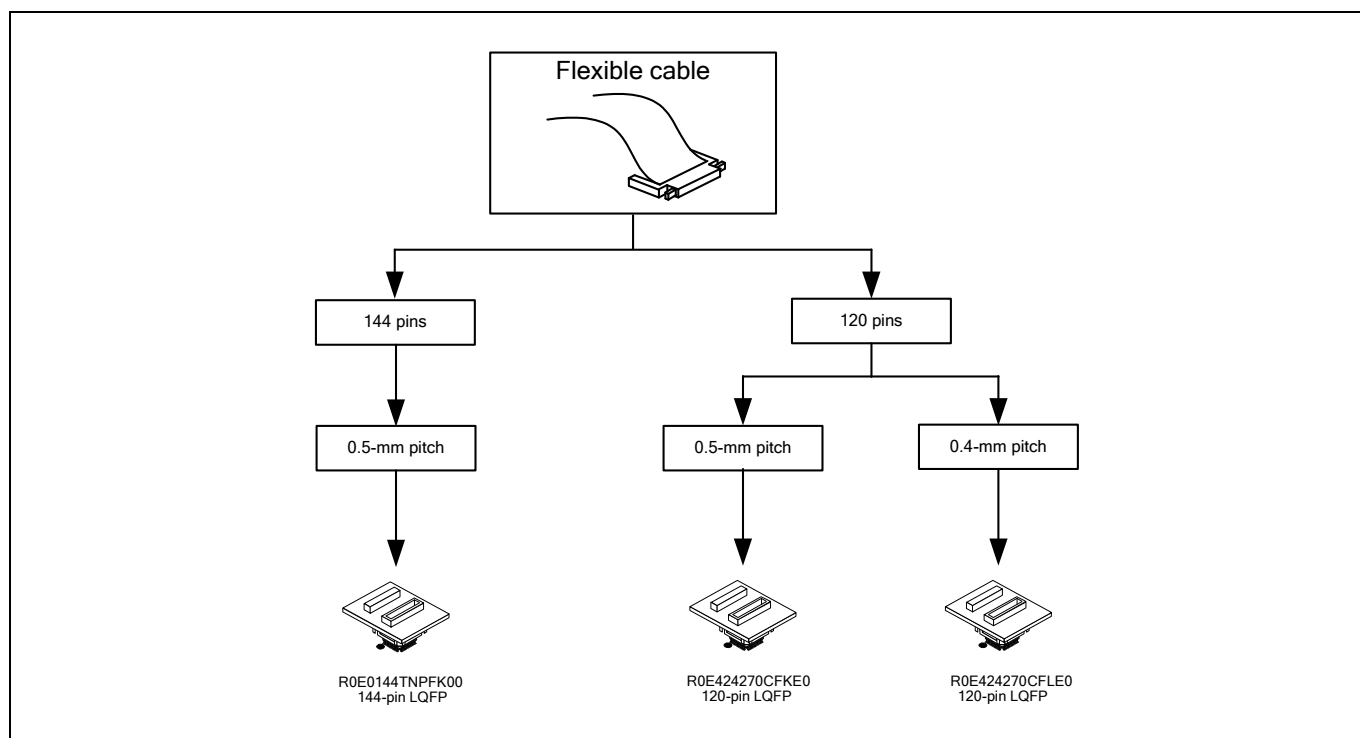

Figure 2.10 Connecting the MCU unit to the user system

CAUTION

Note on Connecting the User System:



- Take care not to attach the converter board in the wrong orientation. Attachment in the wrong orientation may cause fatal damage to the emulator and user system.

2.9.1 Connection to a 120-pin 0.4-mm Pitch Pad Pattern

The following is the procedure for connection to a 120-pin 0.4-mm pitch pad pattern on the user system by using the R0E424270CFLE0 (not included). For details on the R0E424270CFLE0, refer to its user's manual.

- (1) Install the NQPACK120SE-ND, which comes with the R0E424270CFLE0, on the user system.
- (2) Connect the YQPACK120SE, which also comes with the R0E424270CFLE0, to the NQPACK120SE-ND and secure it with the YQ-GUIDEs.
- (3) Connect the R0E424270CFLE0 to the YQPACK120SE.
- (4) Connect CN2 of the R0E424270CFLE0 to CN2 of the flexible cable.
- (5) Connect CN1 of the R0E424270CFLE0 to CN1 of the flexible cable.

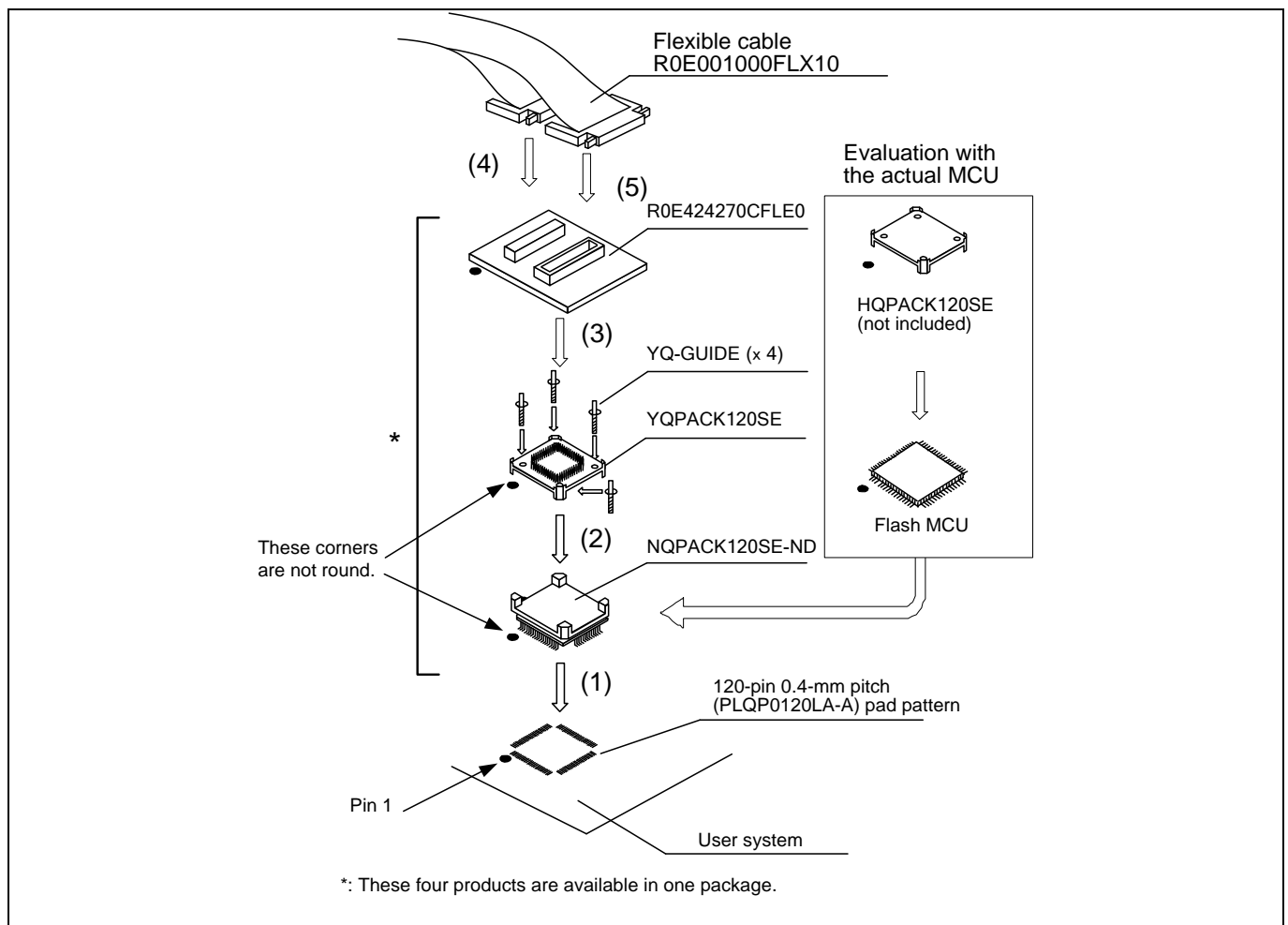

Figure 2.11 Connection to a 120-pin 0.4-mm pitch pad pattern

CAUTION

Notes on Connecting the User System:



- Take care not to attach a converter board in the wrong orientation. Attachment in the wrong orientation may cause fatal damage to the emulator and user system.
- The connectors of the R0E424270CFLE0 are only guaranteed for 50 rounds of insertion and removal.
- For purchasing the HQPACK120SE, contact the following:
Tokyo Eletech Corporation http://www.tetc.co.jp/e_index.htm

2.9.2 Connection to a 120-pin 0.5-mm Pitch Pad Pattern

The following is the procedure for connection to a 120-pin 0.5-mm pitch pad pattern on the user system by using the R0E424270CFKE0 (not included). For details on the R0E424270CFKE0, refer to its user's manual.

- (1) Install the NQPACK120SD, which comes with the R0E424270CFKE0, on the user system.
- (2) Connect the YQPACK120SD, which also comes with the R0E424270CFKE0, to the NQPACK120SD and secure it with the YQ-GUIDEs.
- (3) Connect the R0E424270CFKE0 to the YQPACK120SD.
- (4) Connect CN2 of the R0E424270CFKE0 to CN2 of the flexible cable.
- (5) Connect CN1 of the R0E424270CFKE0 to CN1 of the flexible cable.

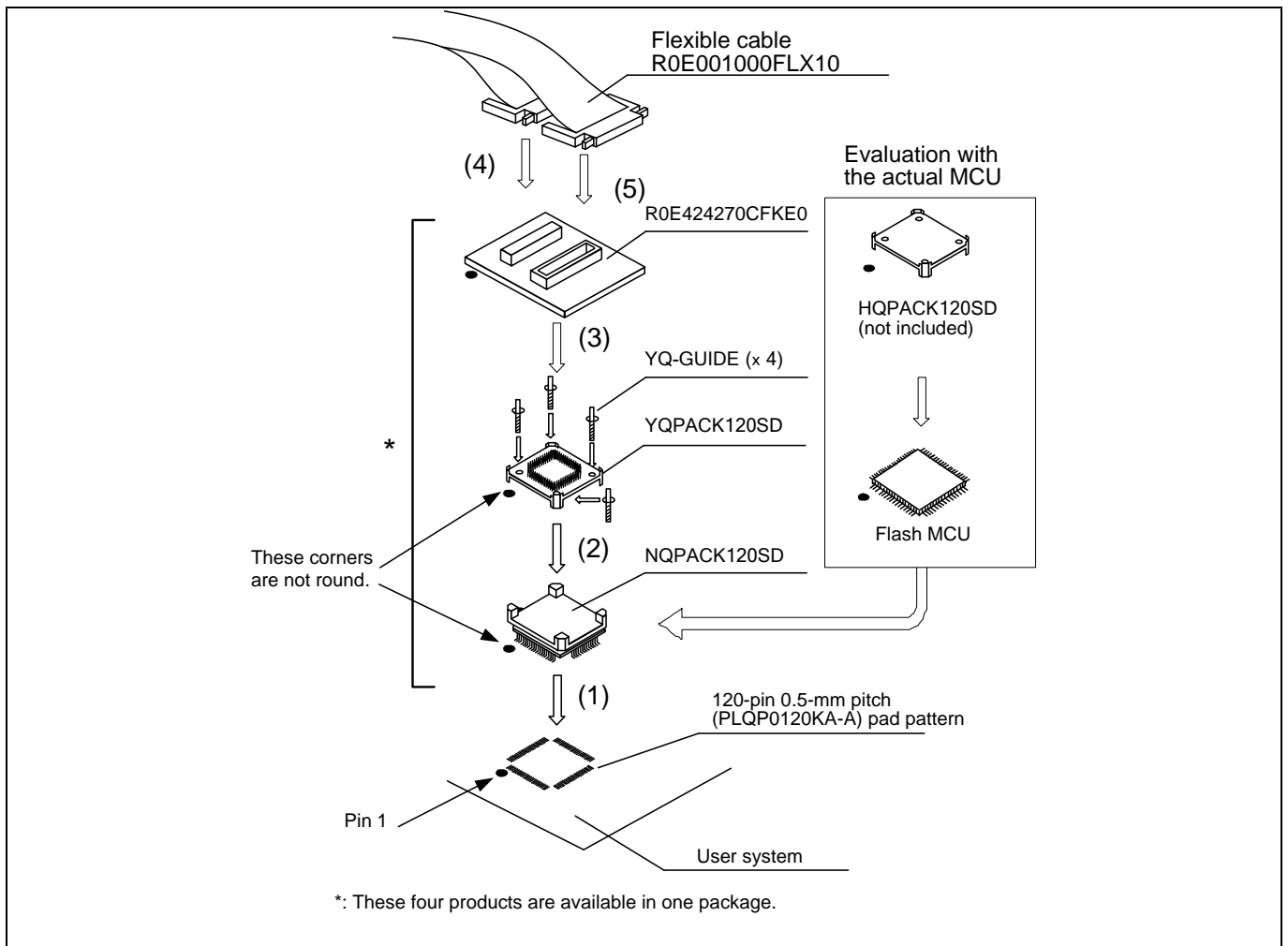

Figure 2.12 Connection to a 120-pin 0.5-mm pitch pad pattern

CAUTION

Notes on Connecting the User System:



- Take care not to attach a converter board in the wrong orientation. Attachment in the wrong orientation may cause fatal damage to the emulator and user system.
- The connectors of the R0E424270CFKE0 are only guaranteed for 50 rounds of insertion and removal.
- For purchasing the HQPACK120SD, contact the following:
Tokyo Eletech Corporation http://www.tetc.co.jp/e_index.htm

2.9.3 Connection to a 144-pin 0.5-mm Pitch Pad Pattern

The following is the procedure for connection to a 144-pin 0.5-mm pitch pad pattern on the user system by using the R0E0144TNPFK00 (not included). For details on the R0E0144TNPFK00, refer to its user's manual.

- (1) Install the NQPACK144SD-ND, which comes with the R0E0144TNPFK00, on the user system.
- (2) Connect the YQPACK144SD, which also comes with the R0E0144TNPFK00, to the NQPACK144SD-ND and secure it with the YQ-GUIDEs.
- (3) Connect the R0E0144TNPFK00 to the YQPACK144SD.
- (4) Connect CN2 of the R0E0144TNPFK00 to CN2 of the flexible cable.
- (5) Connect CN1 of the R0E0144TNPFK00 to CN1 of the flexible cable.

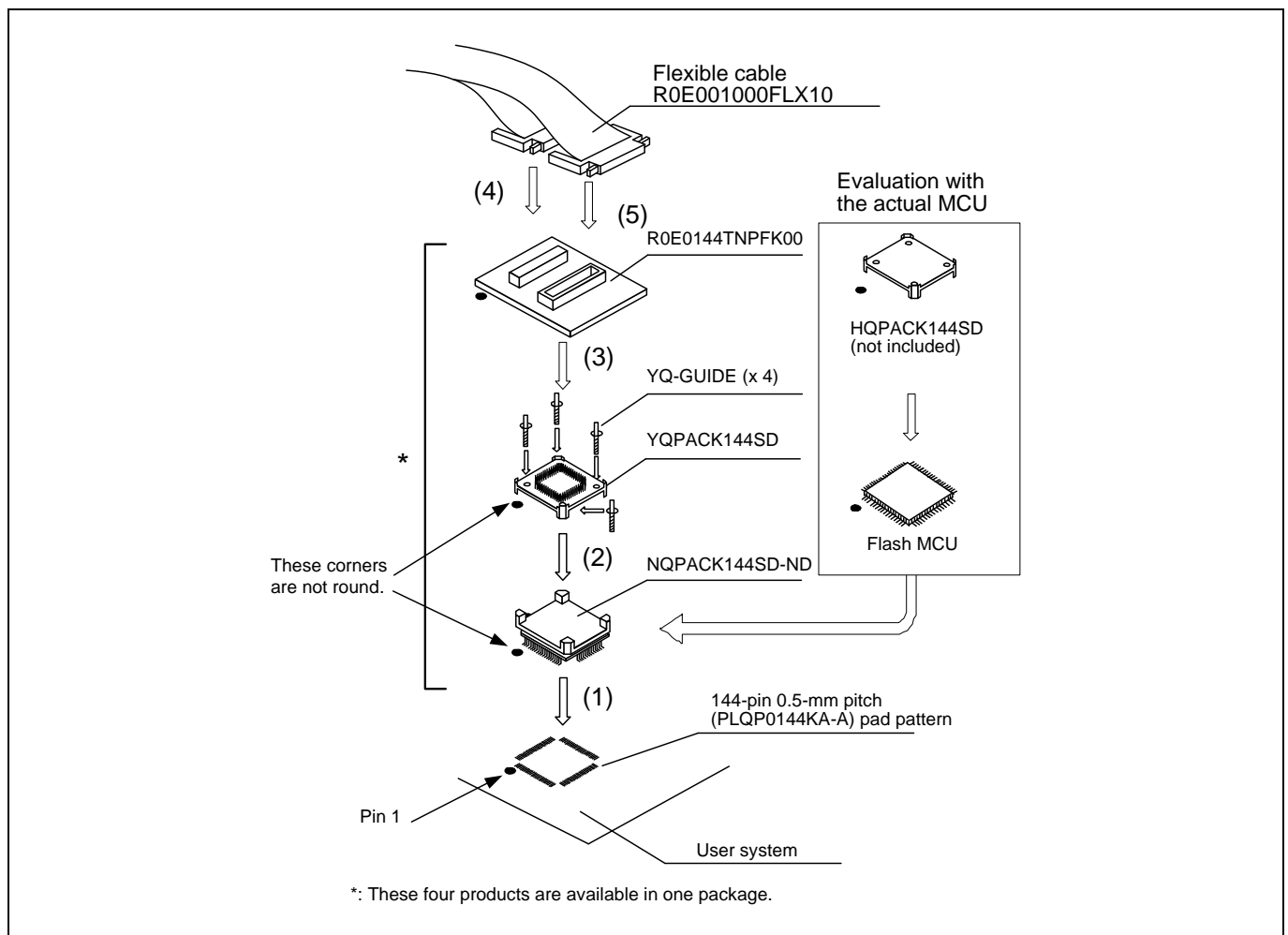

Figure 2.14 Connection to a 144-pin 0.5-mm pitch pad pattern

CAUTION

Notes on Connecting the User System:



- Take care not to attach a converter board in the wrong orientation. Attachment in the wrong orientation may cause fatal damage to the emulator and user system.
- The connectors of the R0E0144TNPFK00 are only guaranteed for 50 rounds of insertion and removal.
- For purchasing the HQPACK144SD, contact the following:
Tokyo Eletech Corporation http://www.tetc.co.jp/e_index.htm

3. Tutorial

3.1 Introduction

A tutorial program for the E100 emulator is provided as a means of presenting the emulator's main features to you. The tutorial is described in this section.

The tutorial program was written in the C and C++ languages, and sorts random data (10 items) into ascending and descending order.

Processing by the tutorial program is as follows.

The main function repeatedly calls the tutorial function in order to repeatedly execute the process of sorting.

The tutorial function generates the random data to be sorted and calls the sort and change functions, in that order.

The sort function accepts input of an array that contains the random data generated by the tutorial function and sorts this data into ascending order.

The change function accepts input of the array that was sorted into ascending order by the sort function and sorts the data into descending order.

The tutorial program is designed to help users to understand how to use the functions of the emulator and emulator debugger. When developing a user system or user program, refer to the user's manual for the target MCU.

CAUTION

If the tutorial program is recompiled, the addresses in the recompiled program may not be the same as those described in this chapter.

3.2 Starting the High-performance Embedded Workshop

Open a workspace by following the procedure described in “4.4 Opening an Existing Workspace” (page 77).

Specify the directory given below.

(Drive where the OS is installed)\Workspace\Tutorial\E100\H8S2400\Tutorial

Specify the file shown below.

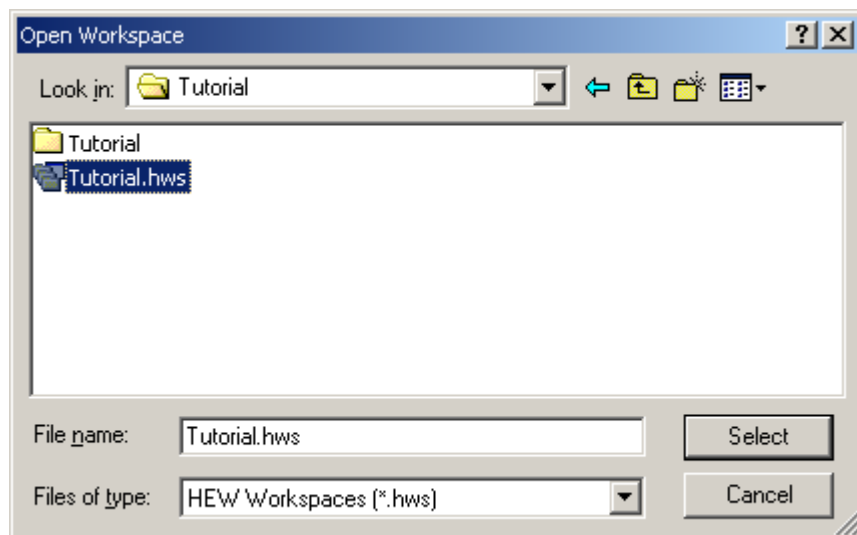

Figure 3.1 Open Workspace dialog box

3.3 Connecting the Emulator

When the debugger is connected to the emulator, a dialog box for setting up the debugger is displayed. Make initial settings of the debugger in this dialog box.

When you have finished setting up the debugger, you are ready to start debugging.

3.4 Downloading the Tutorial Program

3.4.1 Downloading the Tutorial Program

Download the object program you want to debug. Note, however, that the name of a program to be downloaded and the address where the program will be downloaded depend on the MCU in use. Accordingly, strings shown in the screen shots should be altered to those for the MCU in use.

Choose Download for Tutorial.abs under Download modules.

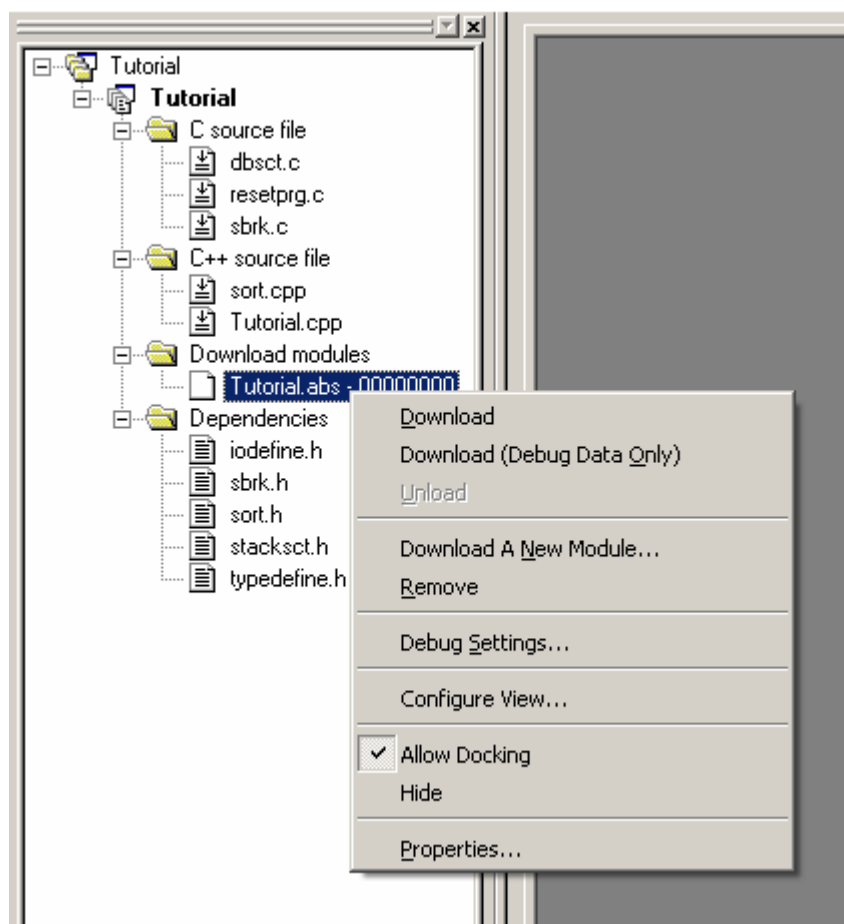

Figure 3.2 Downloading the tutorial program

3.4.2 Displaying the Source Program

In the High-performance Embedded Workshop you can debug programs at the source level.

Double-click on the C++ source file Tutorial.cpp.

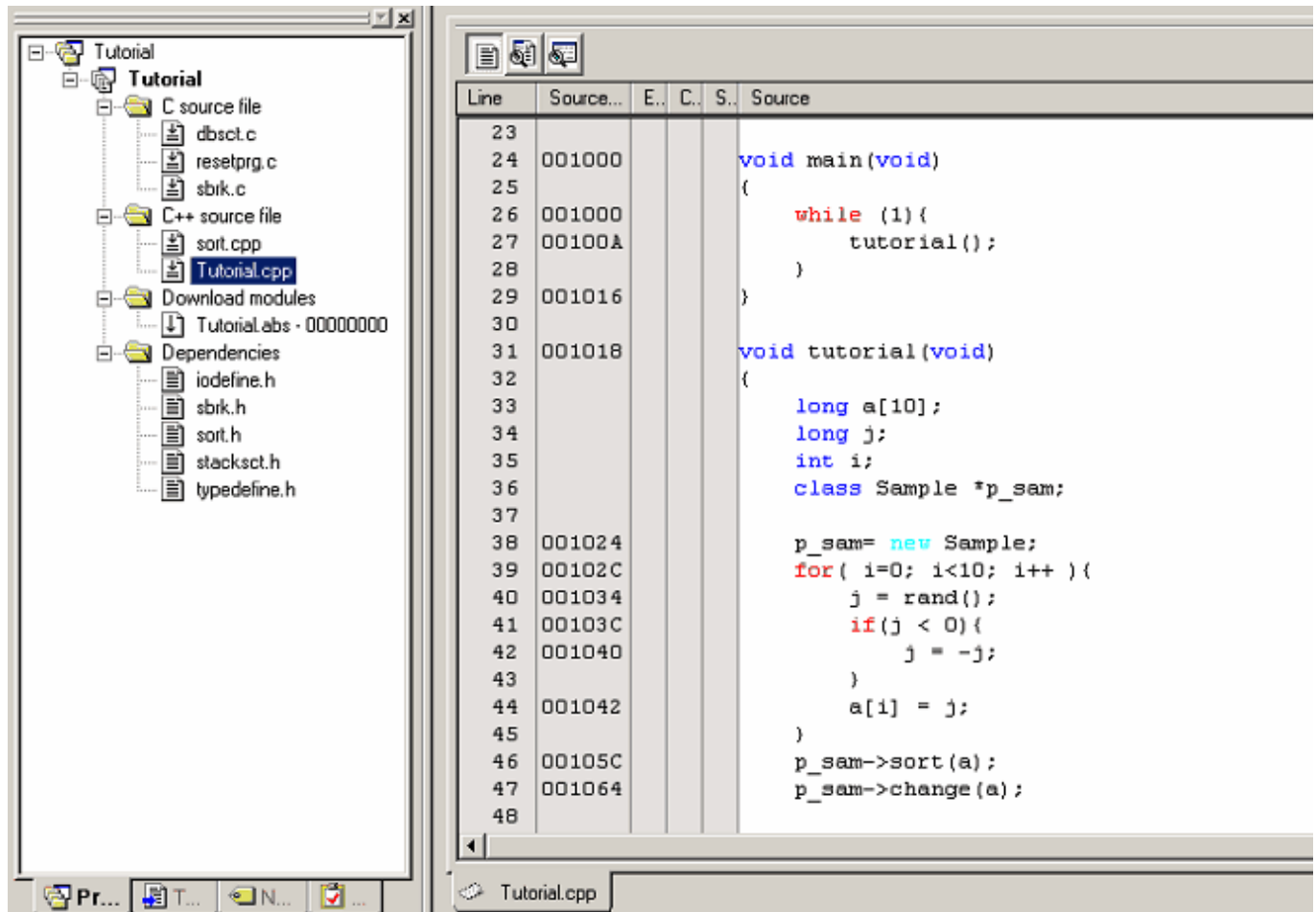

Figure 3.3 Editor window (displaying the source program)

If necessary, you can change the font and size to make the text more easily readable. For details, refer to the High-performance Embedded Workshop User's Manual.

The Editor window initially shows the beginning of the program. Use the scroll bar to view other parts of the program.

3.5 Setting Software Breakpoints

Setting of software breakpoints is one simple debugging facility.

Software breakpoints are easy to set in the Editor window. For example, you can set a software breakpoint at the line where the sort function is called.

Double-click in the row of the S/W Breakpoints column which corresponds to the source line containing the call of the sort function.

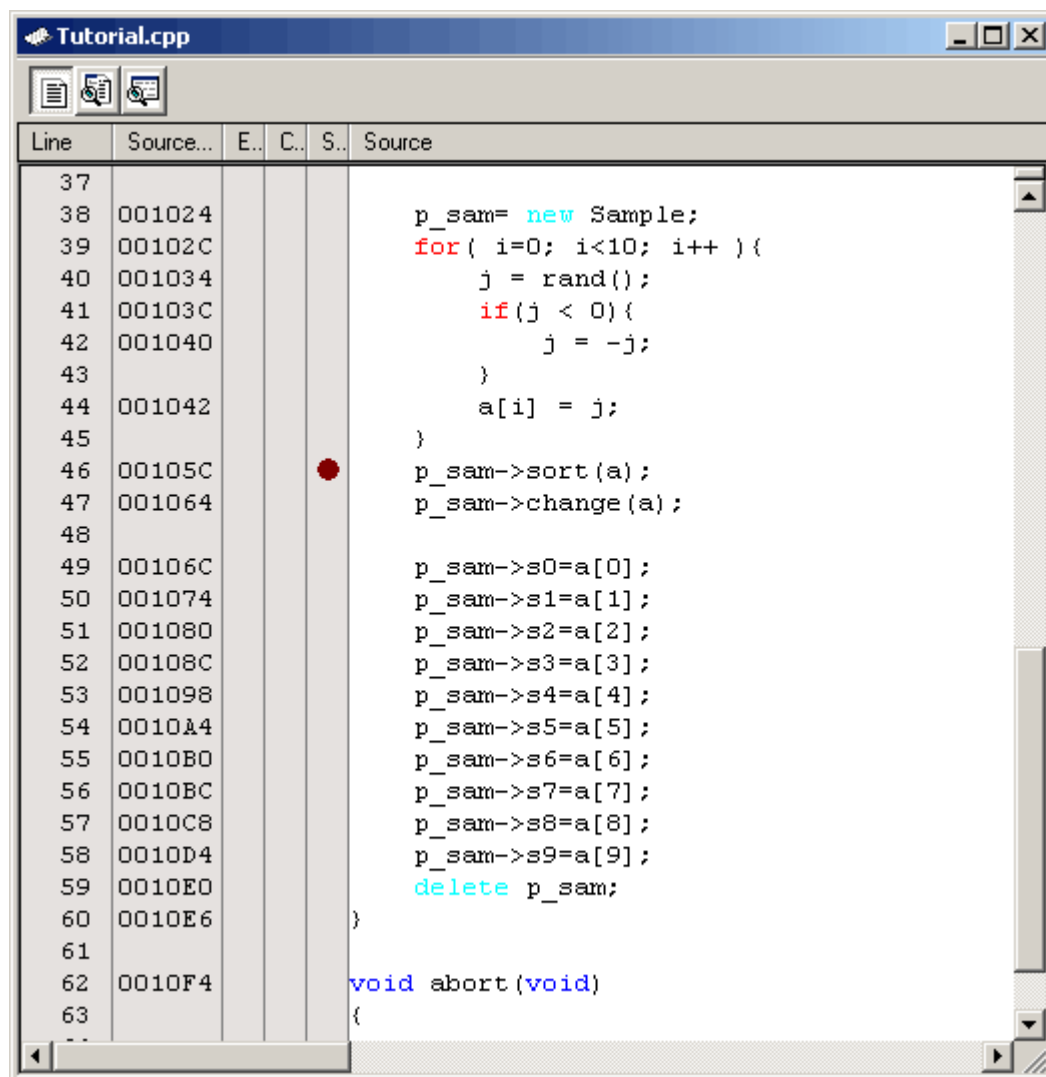



Figure 3.4 Editor window (setting a software breakpoint)

The source line that includes the sort function will be marked with a red circle, indicating that a software breakpoint has been set there.

3.6 Executing the Program

The following describes how to run the program.

3.6.1 Resetting the CPU

To reset the CPU, choose Reset CPU from the Debug menu or click on the Reset CPU toolbar button .

3.6.2 Executing the Program

To execute the program, choose Go from the Debug menu or click on the Go toolbar button .

The program will be executed continuously until a breakpoint is reached. An arrow will be displayed in the S/W Breakpoints column to indicate the position where the program stopped.

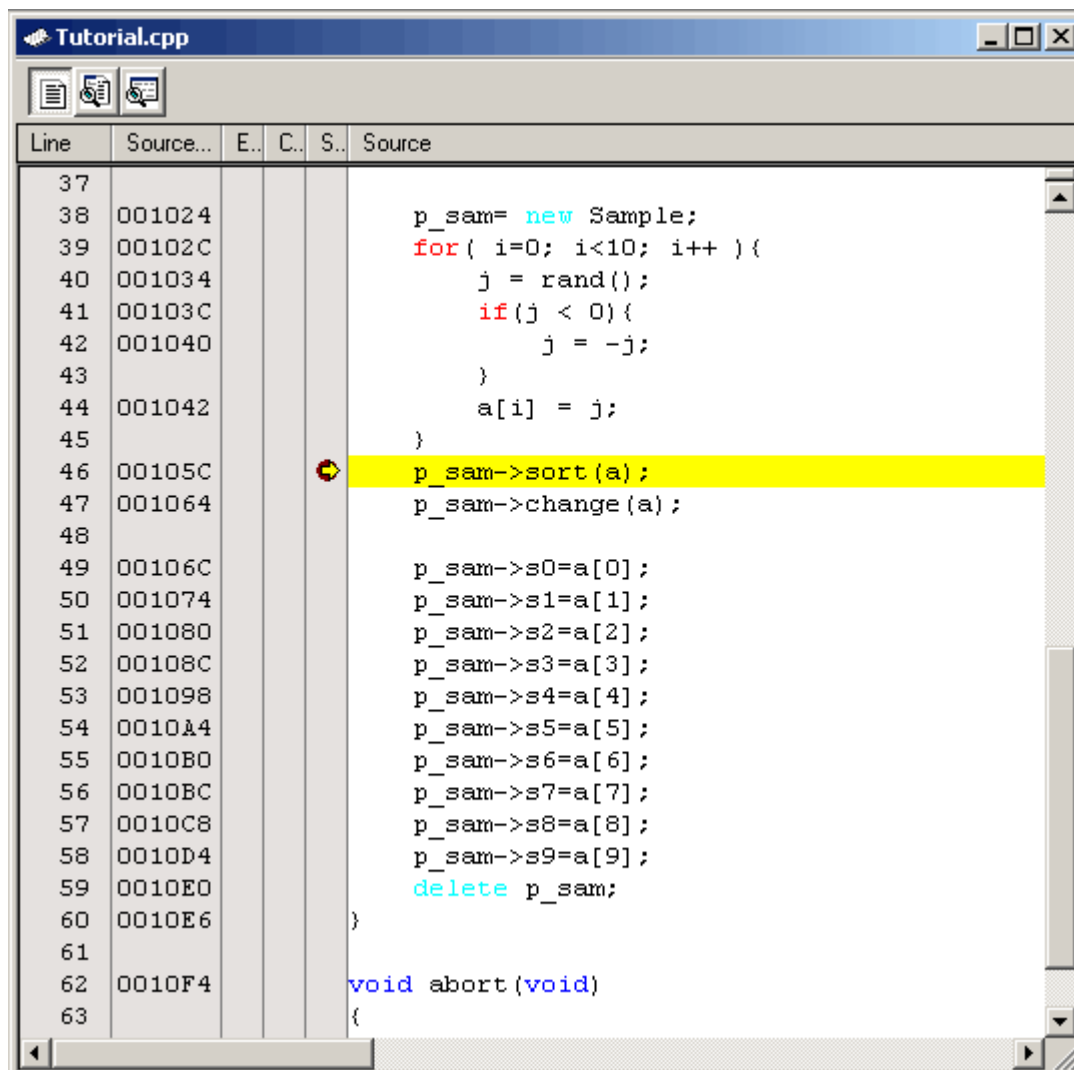



Figure 3.5 Editor window break)

The Status window permits you to check the cause of the last break to have occurred.

Choose CPU → Status from the View menu or click on the View Status toolbar button []. When the Status window is displayed, open the Target sheet and check the cause of the break.

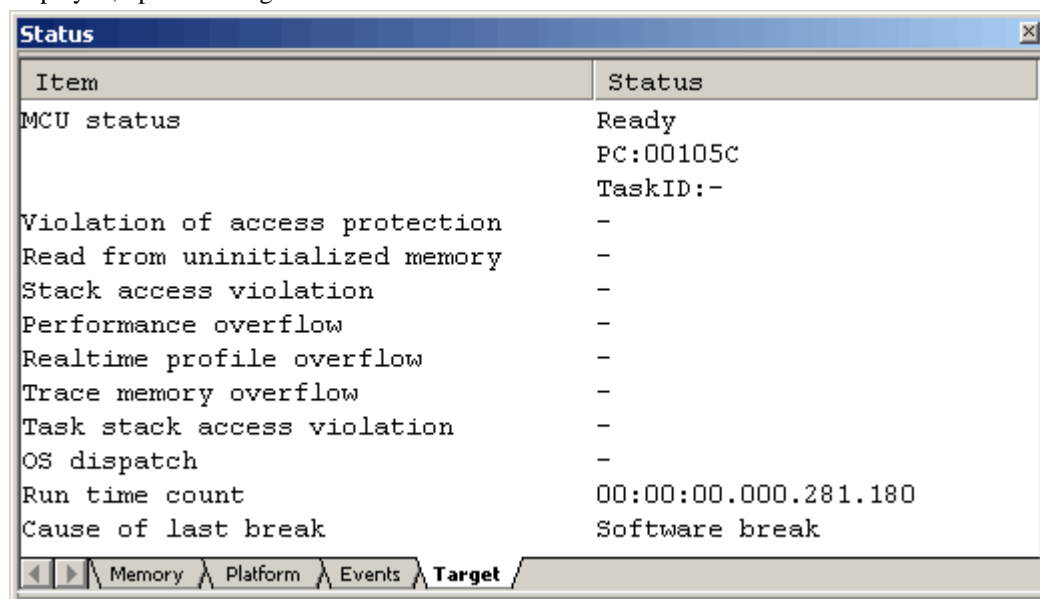

Figure 3.6 Status window

CAUTION

The contents displayed in this window differ with the product. For details of the contents displayed for particular products, refer to Chapter "5. Debugging Functions," (page 81) or the online help.

3.7 Checking Breakpoints

Use the Breakpoints dialog box to check all software breakpoints that have been set.

3.7.1 Checking Breakpoints

Press the keys Ctrl + B on the keyboard of your PC. The Breakpoints dialog box shown below will be displayed.

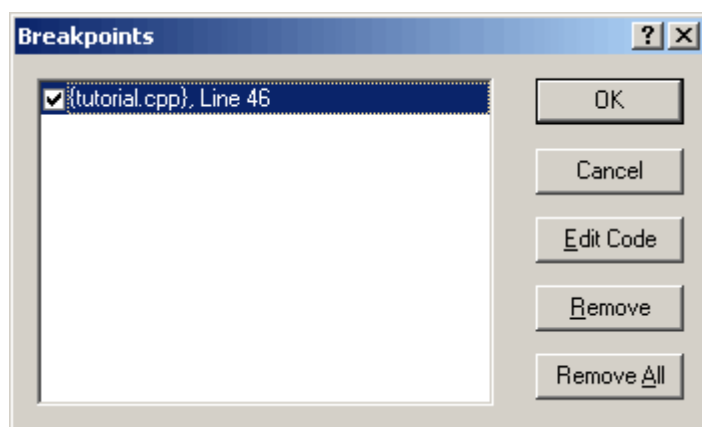

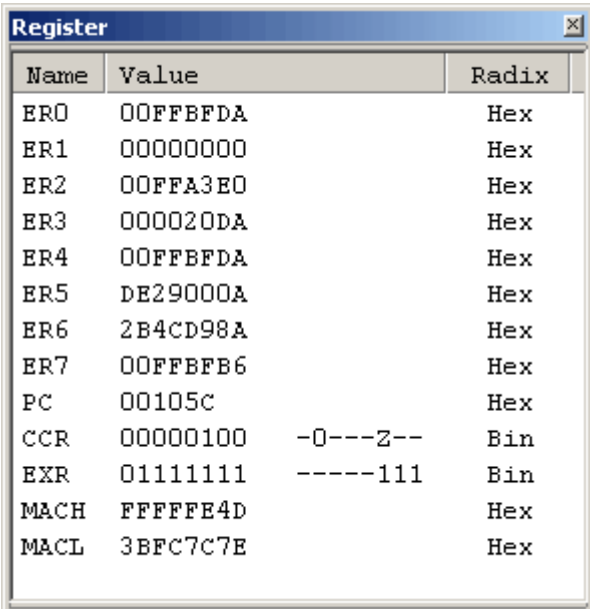

Figure 3.7 Breakpoints dialog box

Use this dialog box to remove a breakpoint or enable or disable a breakpoint.

3.8 Altering Register Contents

Choose CPU -> Registers from the View menu or click on the Registers toolbar button . The Register window shown below will be displayed.



Name	Value	Radix
ER0	00FFBFDA	Hex
ER1	00000000	Hex
ER2	00FFA3E0	Hex
ER3	000020DA	Hex
ER4	00FFBFDA	Hex
ER5	DE29000A	Hex
ER6	2B4CD98A	Hex
ER7	00FFBFB6	Hex
PC	00105C	Hex
CCR	00000100	-0---Z-- Bin
EXR	01111111	-----111 Bin
MACH	FFFFFFE4D	Hex
MACL	3BFC7C7E	Hex

Figure 3.8 Register window

The contents of any register can be altered.

Double-click on the line for the register you want to alter. The dialog box shown below is displayed, allowing you to enter the new value for the register.

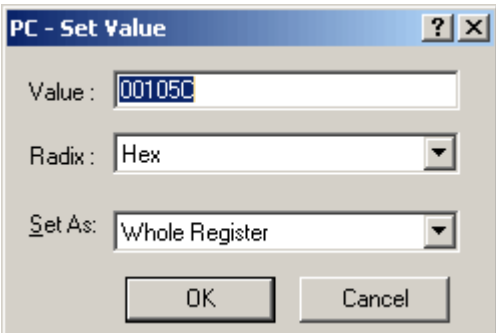

PC - Set Value

Value :

Radix :

Set As:

OK Cancel

Figure 3.9 Set value dialog box (PC)

3.9 Referring to Symbols

The Labels window permits you to view the symbolic information in a module.

Choose Symbols → Labels from the View menu or click on the Labels toolbar button []. The Labels window shown below will be displayed. Use this window to look at the symbolic information a module includes.

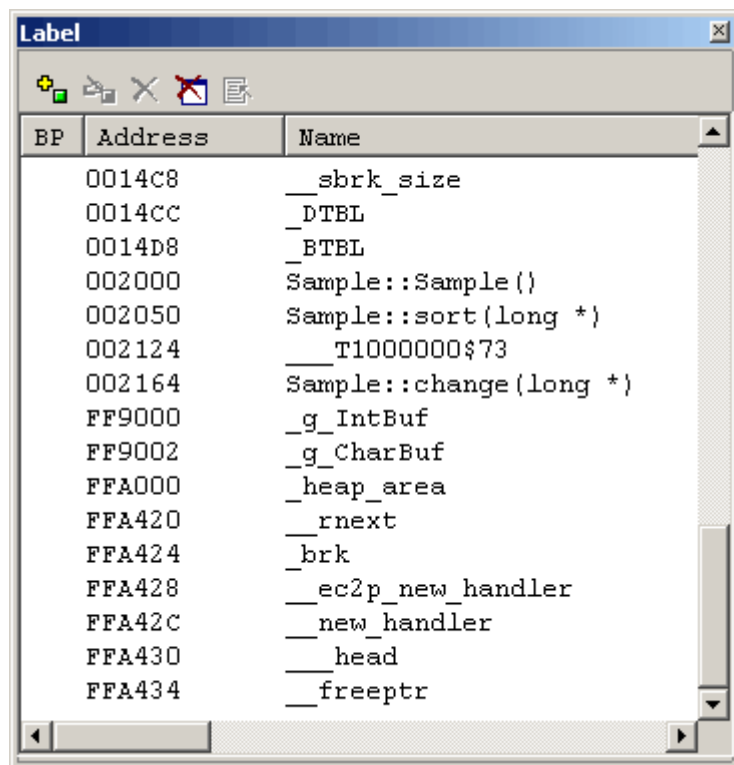



Figure 3.10 Label window

3.10 Checking Memory Contents

After you have specified a label name, you can use the Memory window to check the contents of memory where that label is registered. For example, you can check the contents of memory corresponding to `_main` in byte units, as shown below.

Choose CPU → Memory from the View menu or click on the Memory toolbar button  to open the Display Address dialog box.

Enter “`_main`” in the edit box of the Display Address dialog box.

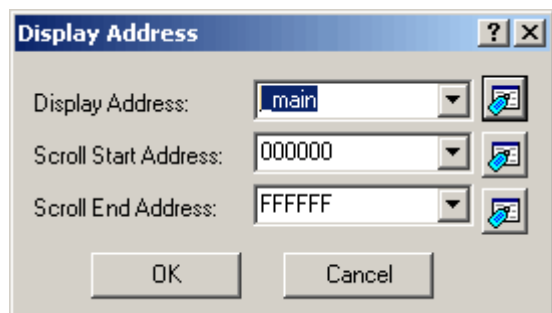

Figure 3.11 Display Address dialog box

Click on the OK button. The Memory window will be displayed, showing a specified memory area.

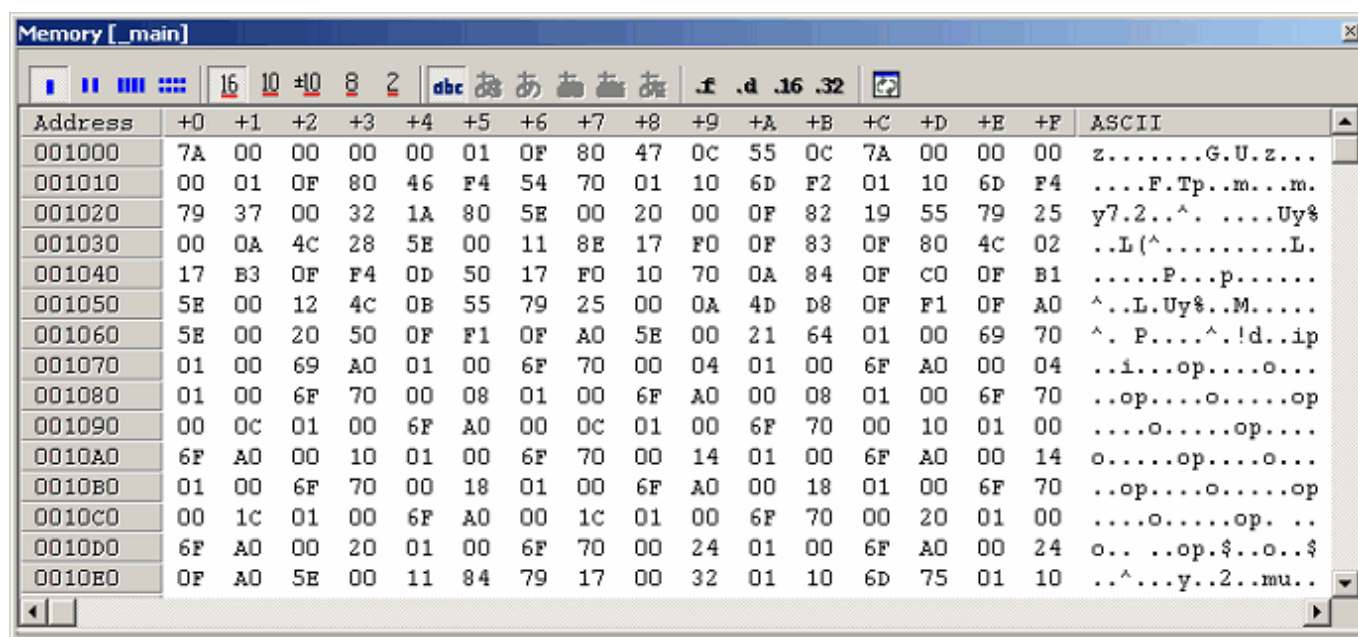

Figure 3.12 Memory window

3.11 Referring to Variables

When single-stepping through a program, you can see how the values of the variables used in the program change as you step through source lines or instructions. For example, by following the procedure described below, you can look at the long-type array 'a' that is declared at the beginning of the program.

Click on the left-hand side of the line containing the array 'a' in the Editor window to place the cursor there. Right-click and select Instant Watch. The dialog box shown below will be displayed.

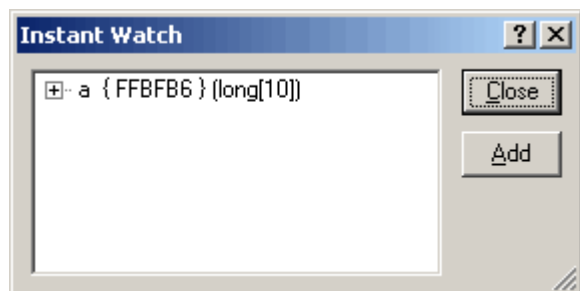

Figure 3.13 Instant Watch dialog box

Click on the Add button to add the variable to the Watch window.

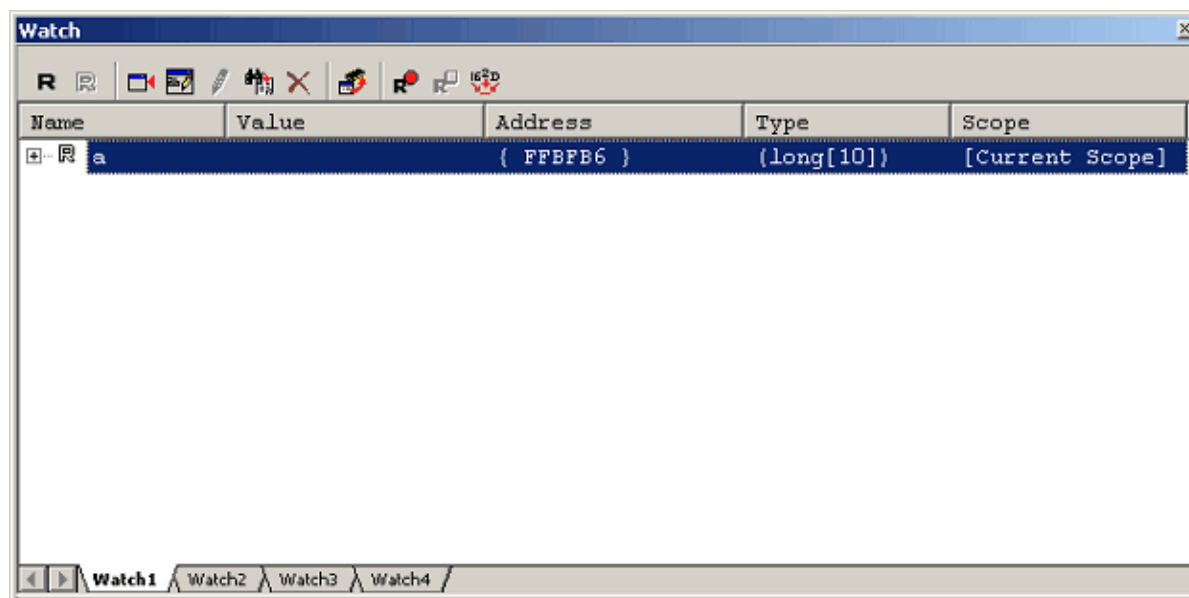

Figure 3.14 Watch window (array display)

Alternatively, you can specify a variable name to be added to the Watch window. Click the right mouse button in the Watch window and choose Add Watch from the popup menu. The dialog box shown below will be displayed.

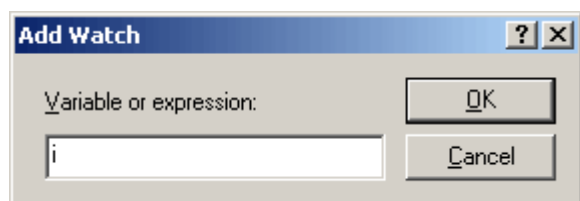

Figure 3.15 Add Watch dialog box

Enter variable 'i' in the Variable or expression edit box and click on the OK button.
 The int-type variable 'i' will be displayed in the Watch window.

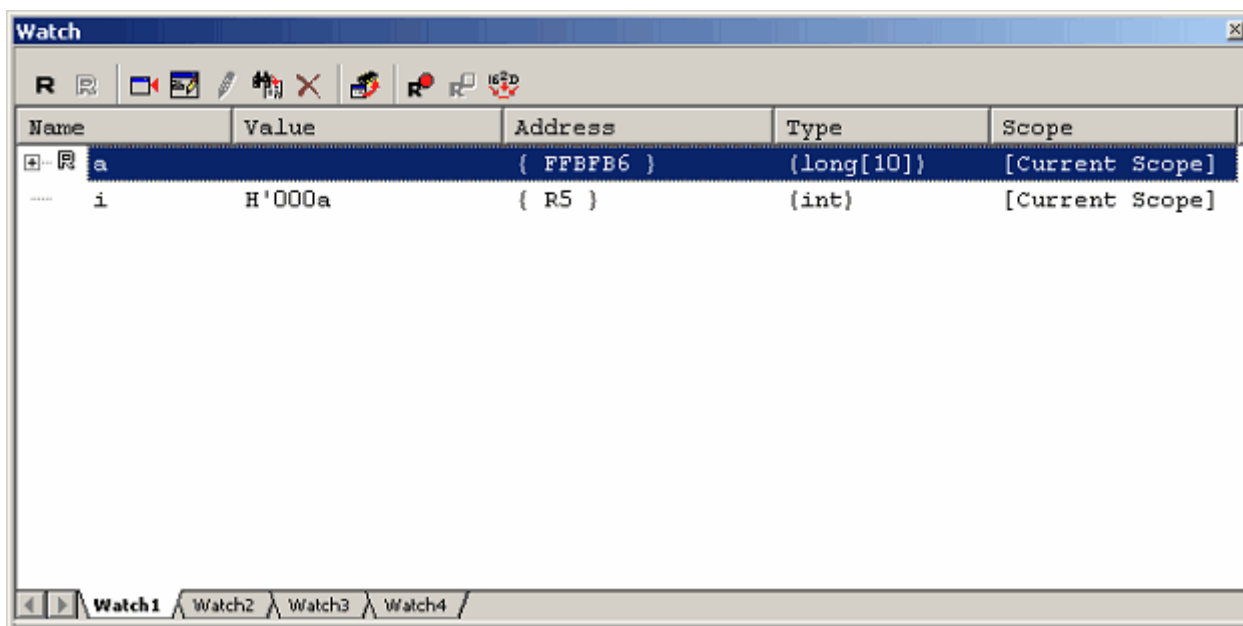

Figure 3.16 Watch window (showing a variable)

Click on the "+" mark shown to the left of the array 'a' in the Watch window. You can now look at the individual elements of the array 'a.'

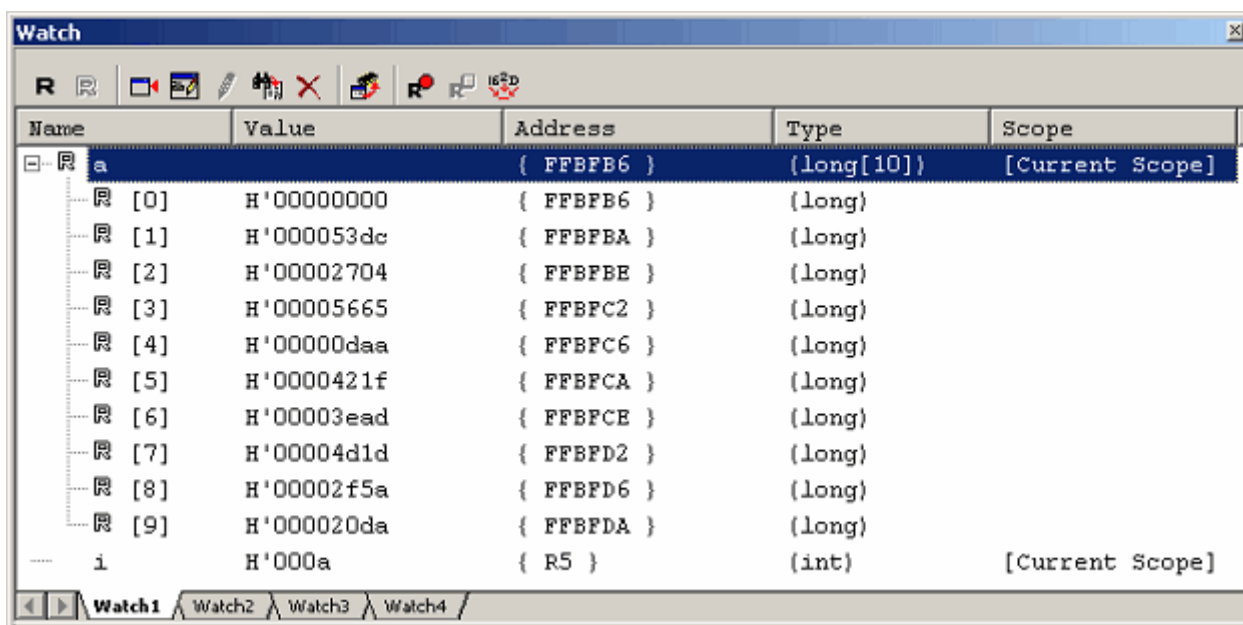



Figure 3.17 Watch window (showing array elements)

3.12 Showing Local Variables

By using the Local window, you can view the local variables included in a function. As an example, let's check the local variables of the tutorial function. Four local variables are declared in this function: 'a,' 'j,' 'i' and 'p_sam.'

Choose Symbols → Local from the View menu or click on the Locals toolbar button  to display the Locals window.

The Locals window shows the values of local variables in the function indicated by the current value of the program counter (PC).

If no variables exist in the function, no information is displayed in the Locals window.

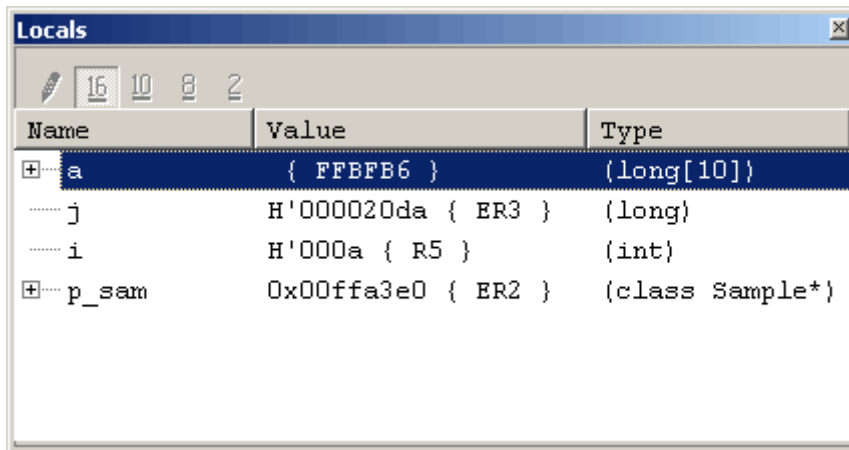

Figure 3.18 Locals window

Click on the “+” mark shown to the left of array a in the Locals window to display the elements comprising array a.

Confirm that the random data are being sorted into ascending order by inspecting the elements of array a before and after execution of the sort function.

3.13 Single-Stepping through a Program

The High-performance Embedded Workshop provides various step commands that will prove useful in debugging programs.

Table 3.1 Step Options

Command	Description
Step In	Executes a program one statement at a time (including statements within functions).
Step Over	Executes a program one statement at a time by 'stepping over' function calls, if there are any.
Step Out	After exiting a function, stops at the next statement of a program that called the function.
Step...	Single-step a program a specified number of times at a specified speed.

3.13.1 Executing Step In Command

The Step In command 'steps in' to a called function and stops at the first statement of the function.

To enter the sort function, choose Step In from the Debug menu or click on the Step In toolbar button.



Figure 3.19 Step In button

Line	Source...	E.	C.	S.	Source
11	002000				Sample::Sample ()
12	002000				{
13	002012				s0=0;
14	002018				s1=0;
15	00201E				s2=0;
16	002024				s3=0;
17	00202A				s4=0;
18	002030				s5=0;
19	002036				s6=0;
20	00203C				s7=0;
21	002042				s8=0;
22	002048				s9=0;
23	00204E				}
24					
25					//-----
26					int g_IntBuf;
27					char g_CharBuf;
28					//-----
29					
30	002050				void Sample::sort(long *a)
31					{
32					long t;
33					int i, j, k, gap;
34					
35	00205C				gap = 5;
36	002062				while(gap > 0){
37	002068				for(k=0; k<gap; k++){
38	002070				for(i=k+gap; i<10; i=i+gap){
39	00207C				for(j=i-gap; j>=k; j=j-gap){
40	002086				g_IntBuf = j;
41	002094				if(a[j]>a[j+gap]){
42	0020C6				t = a[j];
43	0020DC				a[j] = a[j+gap];
44	0020FA				a[j+gap] = t;
45					}
46					else
47					break;
48					}
49					}
50					}
51	002136				gap = gap/2;
52					}
53	002148				g_CharBuf = (char)g_IntBuf & 0x00FF;
54	002156				}

Figure 3.20 Editor window (Step In)

The highlight in the Editor window moves to the first statement of the sort function.

3.13.2 Executing the Step Out Command

The Step Out command takes execution out of a called function by completing its execution at once and only stopping at the next statement of the program from which the function was called.

To exit from the sort function, choose Step Out from the Debug menu or click on the Step Out toolbar button.



Figure 3.21 Step Out button

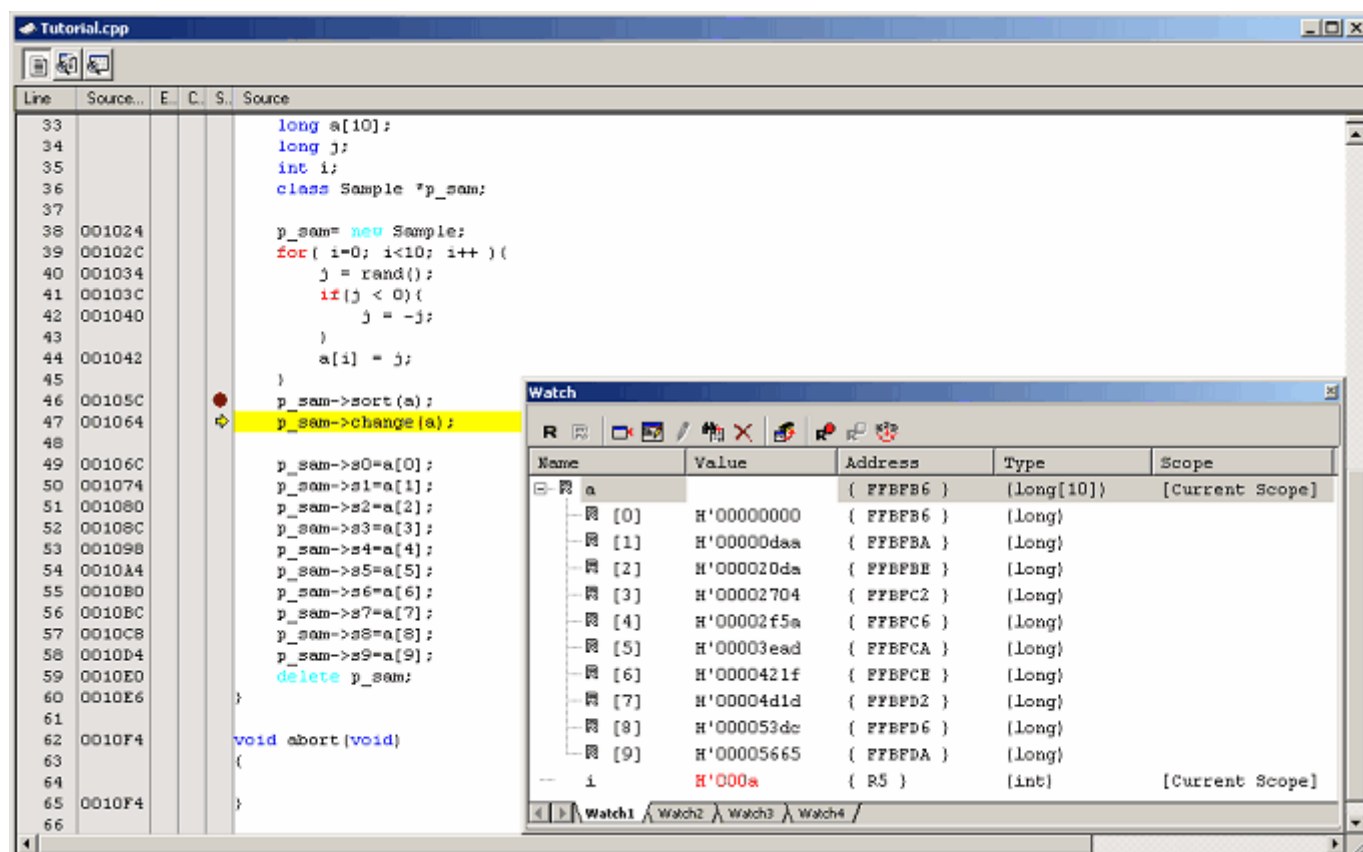

Figure 3.22 Editor window (Step Out)

The data of the variable 'a' displayed in the Watch window will have been sorted into ascending order.

3.13.3 Executing the Step Over Command

The Step Over command executes the whole of a function call as one step and then stops at the next statement of the main program.

To execute all statements in the change function at once, choose Step Over from the Debug menu or click on the Step Over toolbar button.



Figure 3.23 Step Over button

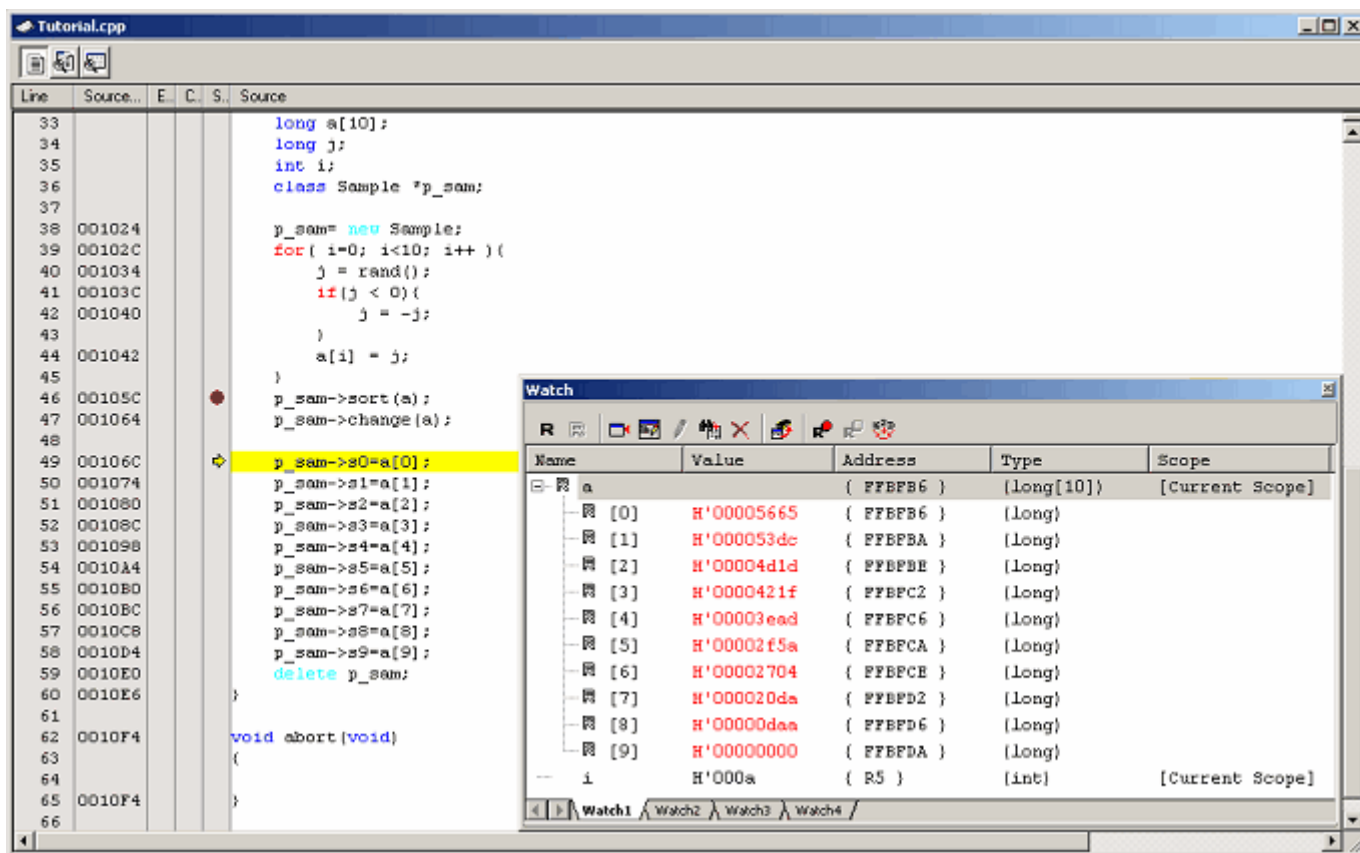

Figure 3.24 Editor window (Step Over)

The data of the variable 'a' displayed in the Watch window will have been sorted into descending order.

3.14 Forcibly Breaking Program Execution

The High-performance Embedded Workshop permits you to forcibly break program execution.

Clear all breakpoints.

To execute the rest of the tutorial function, choose Go from the Debug menu or click on the Go toolbar button.



Figure 3.25 Go button

Since the program execution is now in an endless loop, choose Stop Program from the Debug menu or click on the Halt toolbar button.



Figure 3.26 Halt button

3.15 Hardware Break Facility

A hardware break causes the program to stop when it executes the instruction at a specified address (instruction fetch) or reads from or writes to a specified memory location (data access).

3.15.1 Stopping a Program when It Executes the Instruction at a Specified Address

It's easy to set an instruction fetch event in the Editor window. For example, you can set an instruction fetch event where the sort function is called.

Double-click in the row of the Event column which corresponds to the source line containing the call of the sort function.

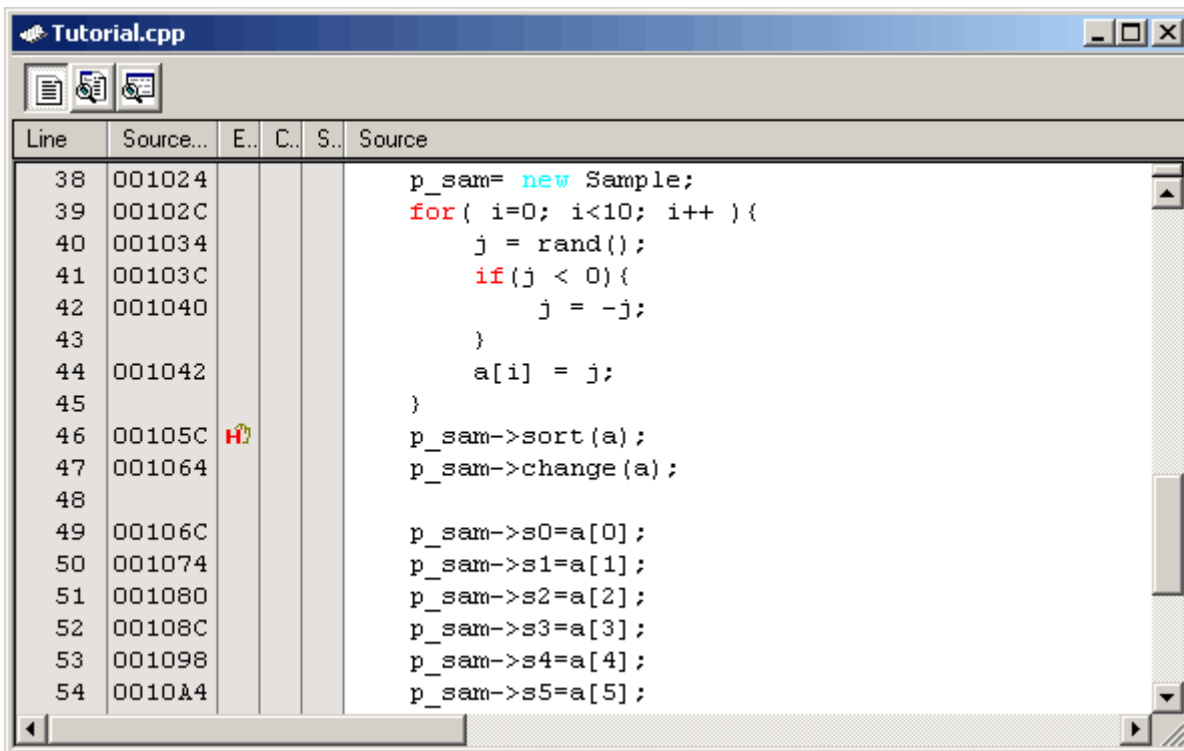



Figure 3.27 Editor window (setting a hardware breakpoint)

The source line that includes the sort function will be marked with , indicating that a hardware breakpoint has been set there. This will cause the program to stop when it fetches the corresponding instruction.

3.16 Stopping a Program when It Accesses Memory

To make a program stop when it reads or writes the value of a global variable, follow the procedure below.

Choose Event -> Hardware Break from the View menu to open the Hardware Break dialog box.

Open the OR page of the Hardware Break dialog box. Select a global variable in the Editor window, and drag-and-drop the selected variable into the OR page so that the program will stop when it reads or writes the value of that variable.

Then click on the Apply button.

The program will stop running when it reads or writes the value of the global variable you have set.

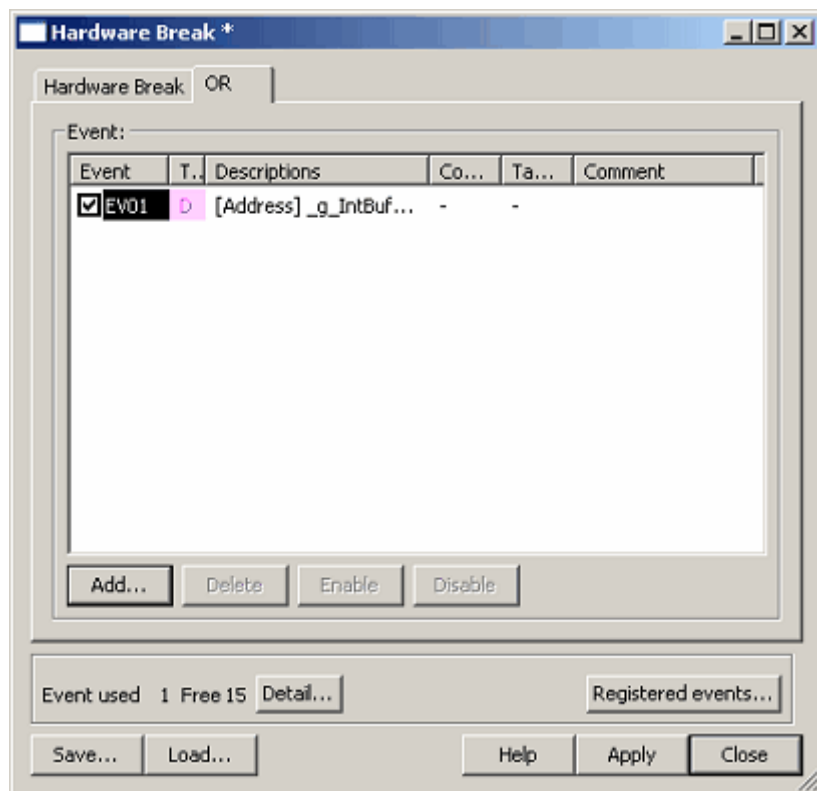



Figure 3.28 Hardware Break dialog box

- Notes:
- (1) To be selectable, a global variable must be represented by 1, 2, or 4 bytes in memory.
 - (2) Local variables cannot be set as hardware-break conditions.

3.17 Tracing Facility

The tracing facility of the E100 emulator includes a special memory unit known as “trace memory” that can hold a record of the execution of up to 4-M bus cycles. This memory is constantly updated during program execution. The contents of trace memory are displayed in the Trace window.

Choose Code → Trace from the View menu or click on the Trace toolbar button .

The Trace window shown below will be displayed.

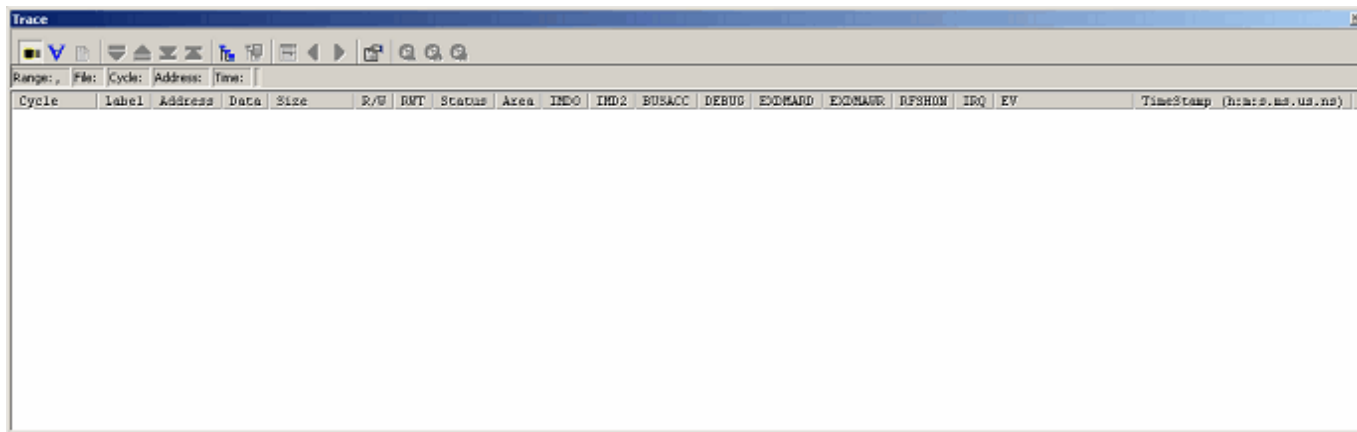

Figure 3.29 Trace window

The following section gives an outline of the tracing facility and how to set up the facility.

3.17.1 Showing the Information Acquired in “Fill Until Stop” Tracing

In “fill until stop” tracing, trace information is successively acquired from the start of user program execution until a break is encountered.

- (1) Clear all break conditions. Click the right mouse button with the cursor anywhere in the Trace window and choose Acquisition from the popup menu. The Trace conditions dialog box shown below will be displayed. Check that the selected trace mode is Fill until stop. Click on the Close button.

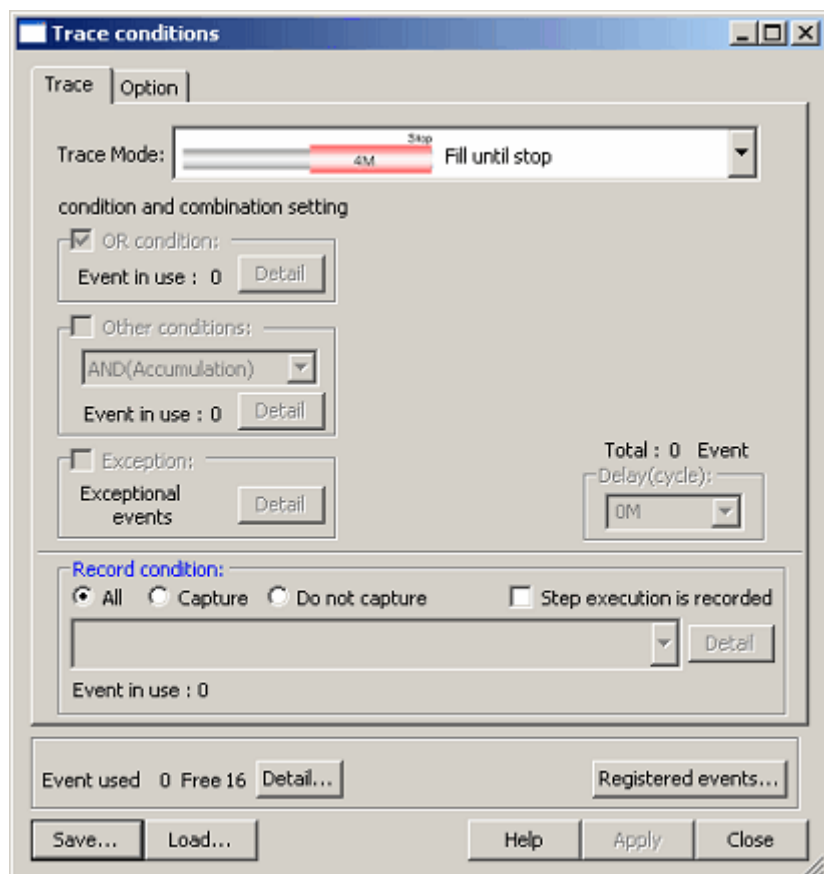

Figure 3.30 Trace conditions dialog box (fill until stop)

(2) Set a software break on the following line of the tutorial function: “p_sam ->s0=a[0];”.

(3) Choose Reset Go from the Debug menu. Processing will be halted by the break, and the trace information acquired prior to the break will be displayed in the Trace window.

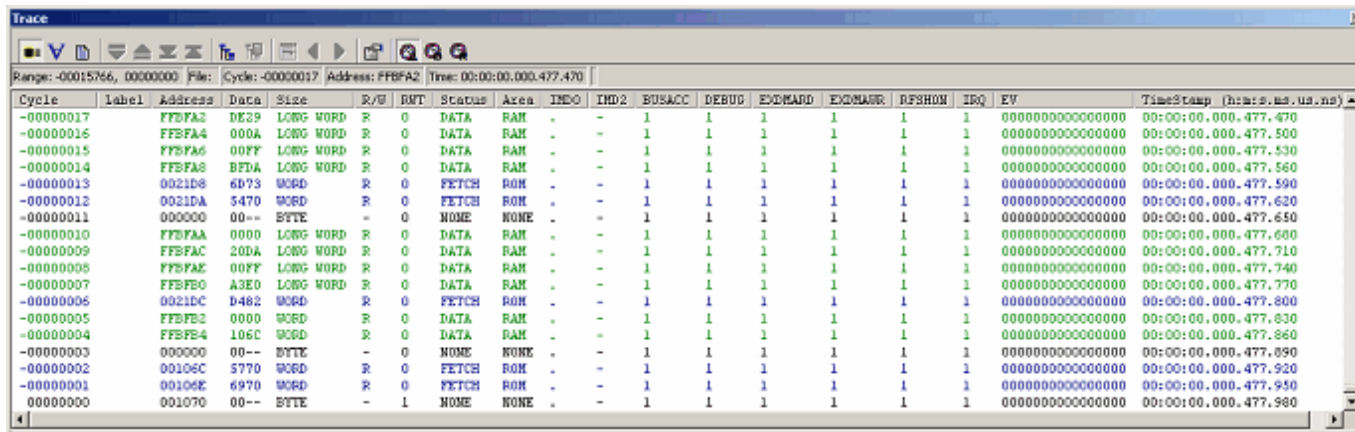

Figure 3.31 Trace window (fill-until-stop tracing)

(4) A mixed display of bus information and disassembly listing is possible. Choose Display Mode -> DIS from the popup menu to view trace information in mixed bus and disassembly mode.

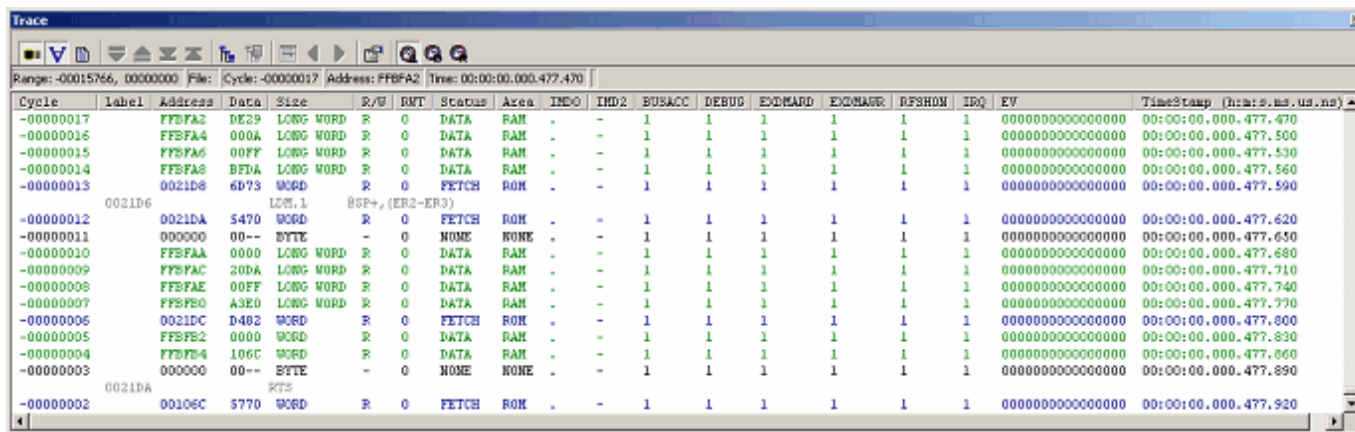

Figure 3.32 Trace window (mixed bus and disassembly mode)

(5) Choosing Display Mode → SRC from the popup menu, on the other hand, shows a mixture of bus information, disassembly listing, and source code as the trace information.

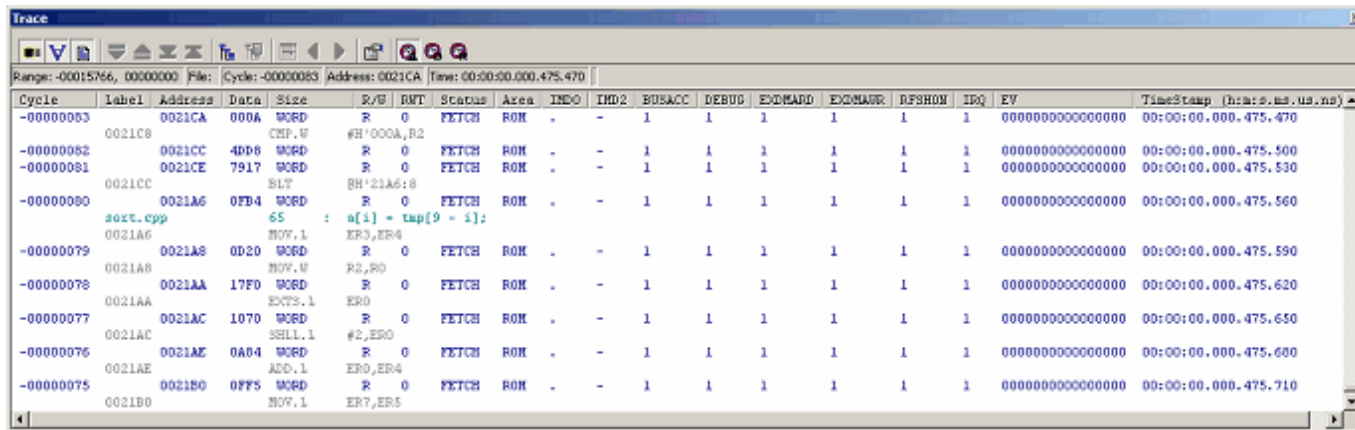

Figure 3.33 Trace window (mixed bus, disassembly, and source mode)

3.17.2 Showing the Information Acquired in "Fill around TP" Tracing

In "fill around TP" tracing, the acquisition of trace information is stopped a specified number of cycles after a trace point is encountered. This facility allows you to use trace information to keep track of program flow without having to break the user program.

- (1) If any break conditions are set, clear all of them.
- (2) Choose "Fill around TP" as the trace mode in the Trace conditions dialog box. In the Delay (cycle) section, specify 4M. (Up to 4-M cycles of trace information from where a trace point is encountered will be acquired.)

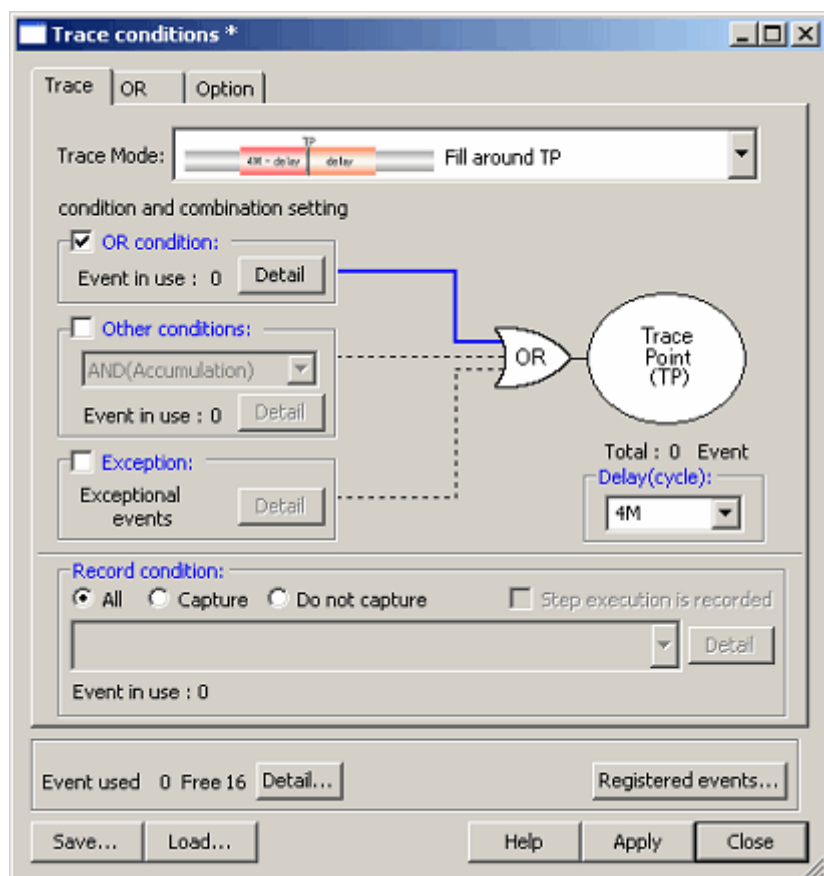

Figure 3.34 Trace conditions dialog box (Fill around TP)

(3) Next, set the trace point, i.e. the point where the debugger will start acquiring trace information. Open the OR page of the Trace conditions dialog box. Select the main function in the Editor window and drag-and-drop it onto the OR page. Click on the Apply button and then the Close button.

Thus, the debugger will start acquiring trace information when the main function is executed.

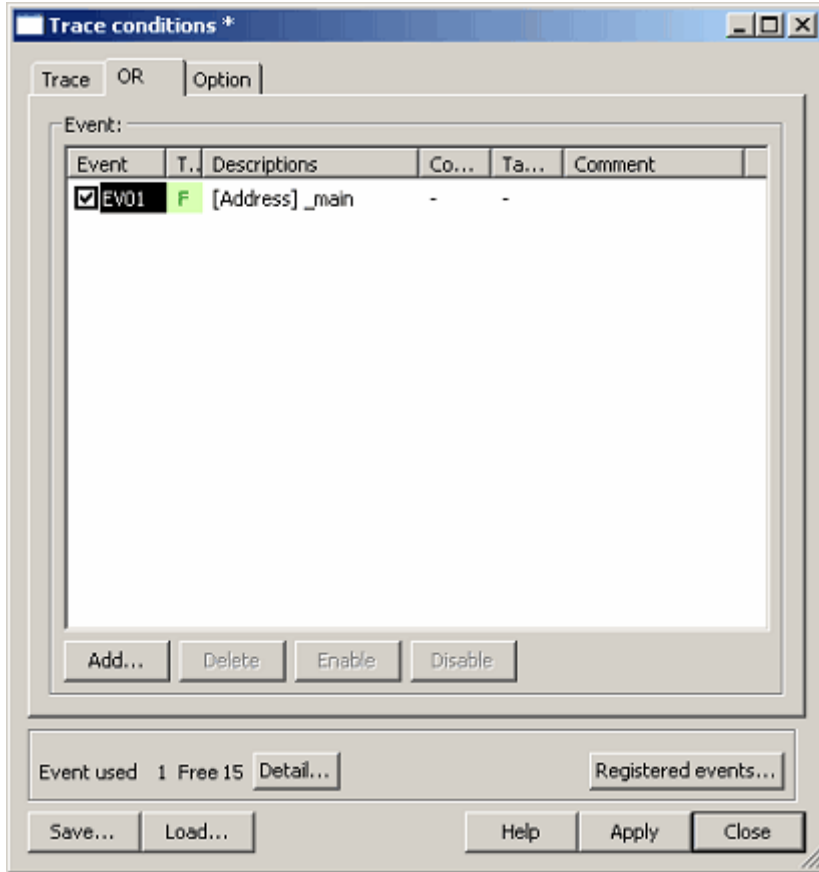

Figure 3.35 Trace conditions dialog box (OR page)

(4) Choose Reset Go from the Debug menu. As soon as the trace point is reached, trace information as shown below will start to be displayed in the Trace window.

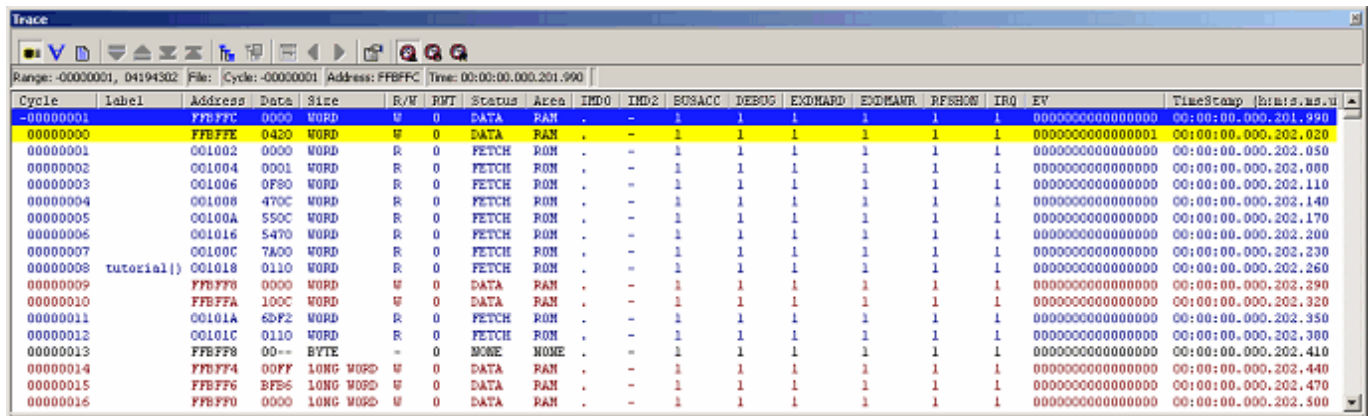

Figure 3.36 Trace window (Fill around TP)

3.17.3 Showing a History of Function Execution

A function execution history can be displayed from the acquired trace information.

You can extract the history of executed functions from the acquired trace information.

- (1) Clear all break conditions. Click the right mouse button with the cursor anywhere in the Trace window and choose Acquisition from the popup menu. The Trace conditions dialog box will open. Switch to fill-until-stop tracing and click on the Apply button and then the Close button.
- (2) Set a software break on the following line of the tutorial function: "p_sam->s0=a[0];".
- (3) Choose Reset Go from the Debug menu. Processing will be halted by the break, and the trace information acquired prior to the break will be displayed in the Trace window.
- (4) Click the right mouse button with the cursor anywhere in the Trace window and choose Function Execution History -> Function Execution History from the popup menu.

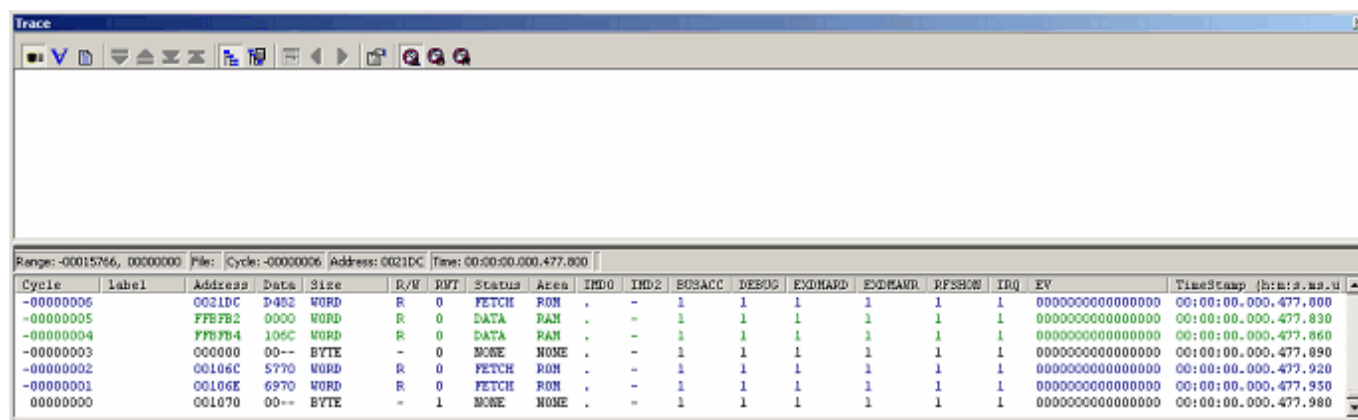

Figure 3.37 Trace window (function execution history—before analysis)

- (5) Click the right mouse button with the cursor anywhere in the upper pane of the Trace window and choose Analyze Execution History from the popup menu. The history of function execution will be displayed in the upper pane.

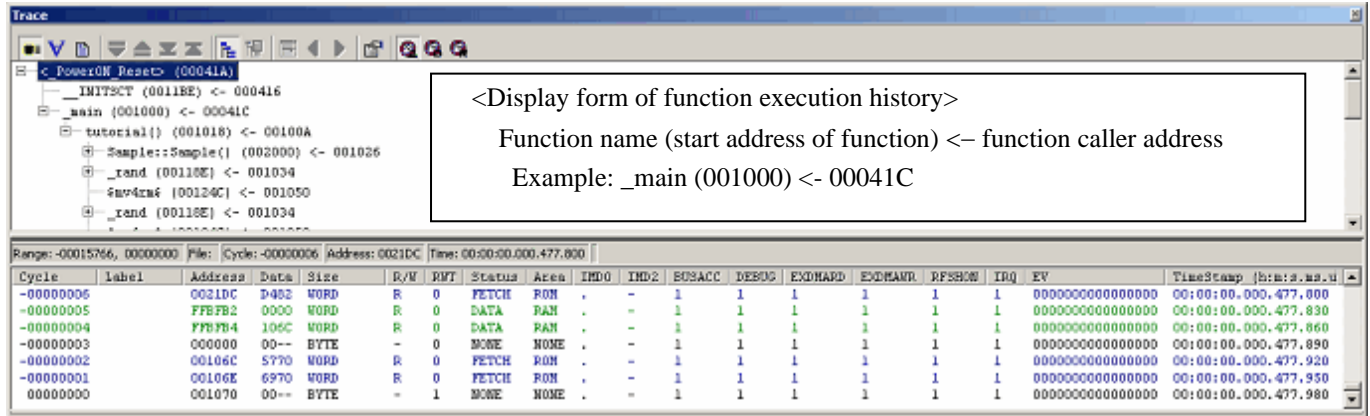

Figure 3.38 Trace window (function execution history–after analysis)

- (6) Double-click on a function in the upper pane to view the trace information corresponding to that function in the lower pane.

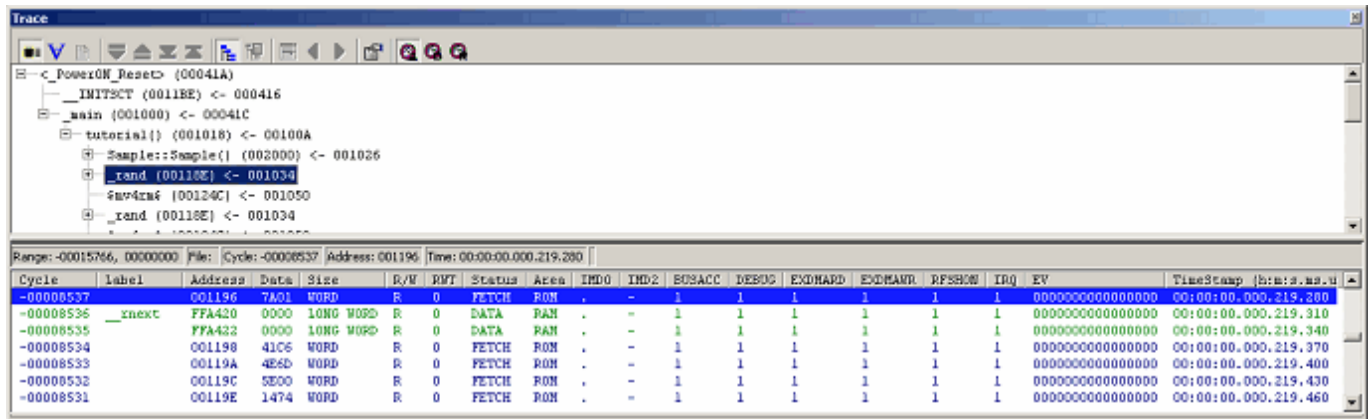

Figure 3.39 Trace window (function execution history)

3.17.4 Filter Facility

Use the filtering facility to extract specific cycles from the acquired trace information.

This is achieved by software filtering of the trace information that was acquired by hardware.

Unlike the “Capture/Do not Capture conditions” where you set conditions for acquisition before getting the trace information, this facility allows you to change filter settings for the acquired trace information any number of times without having to reexecute the program. This makes it easy to extract the information you need.

- (1) Clear all break conditions. Click the right mouse button with the cursor anywhere in the Trace window and choose Acquisition from the popup menu that is displayed. The Trace conditions dialog box will be displayed. Check that the selected trace mode is Fill until stop. Click the Close button.
- (2) Set a software break on the following line of the tutorial function: “p_sam->s0=a[0];”.
- (3) Choose Reset Go from the Debug menu. Processing will be halted by the break, and the trace information acquired prior to the break will be displayed in the Trace window.
- (4) Choose Auto Filter from the popup menu of the Trace window. The columns for which filtering can be applied will be marked by a button.

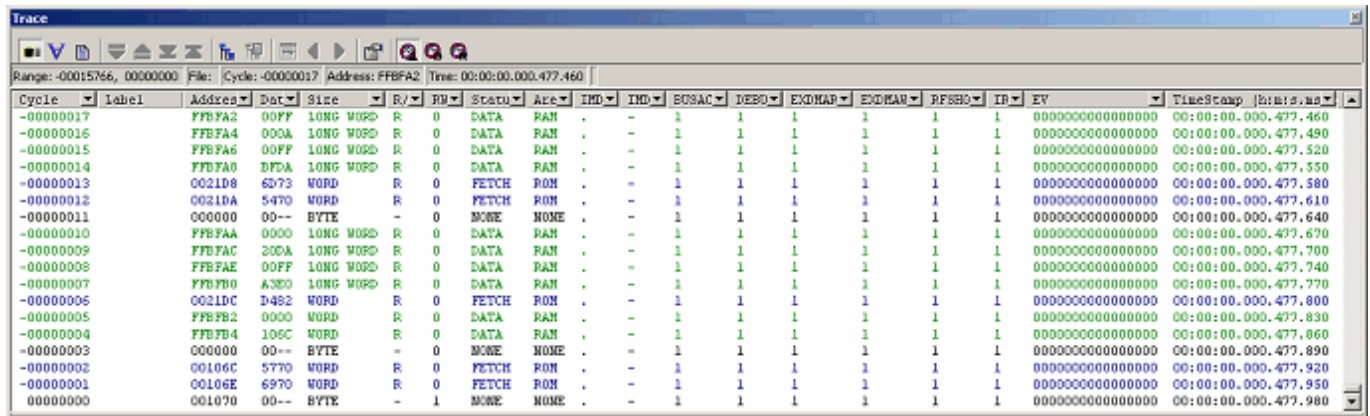

Figure 3.40 Trace window (Auto Filter)

(5) Click on the [▼] button in the R/W column and choose R.

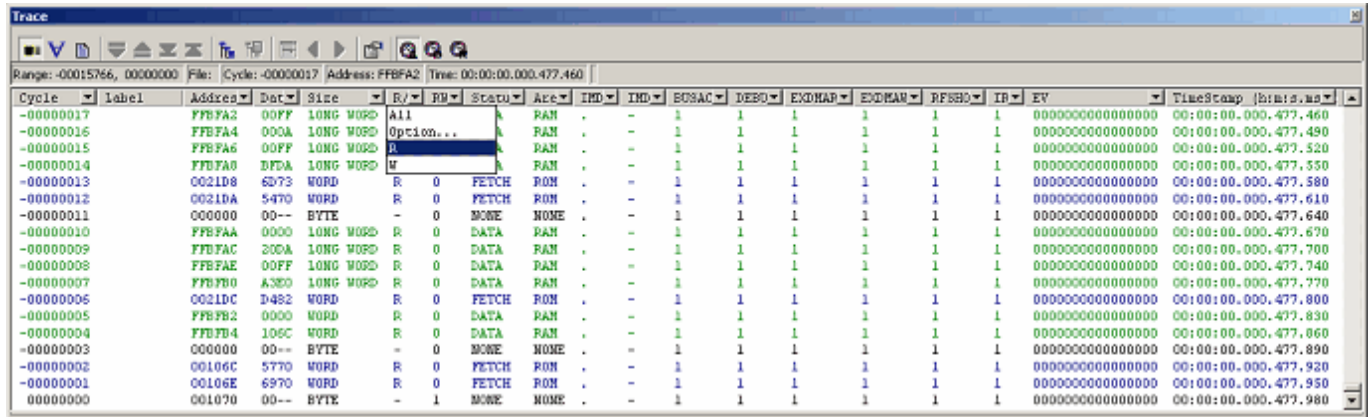

Figure 3.41 Trace window (Auto Filter)

(6) The Trace window now only shows trace information for cycles that have R in the R/W column.

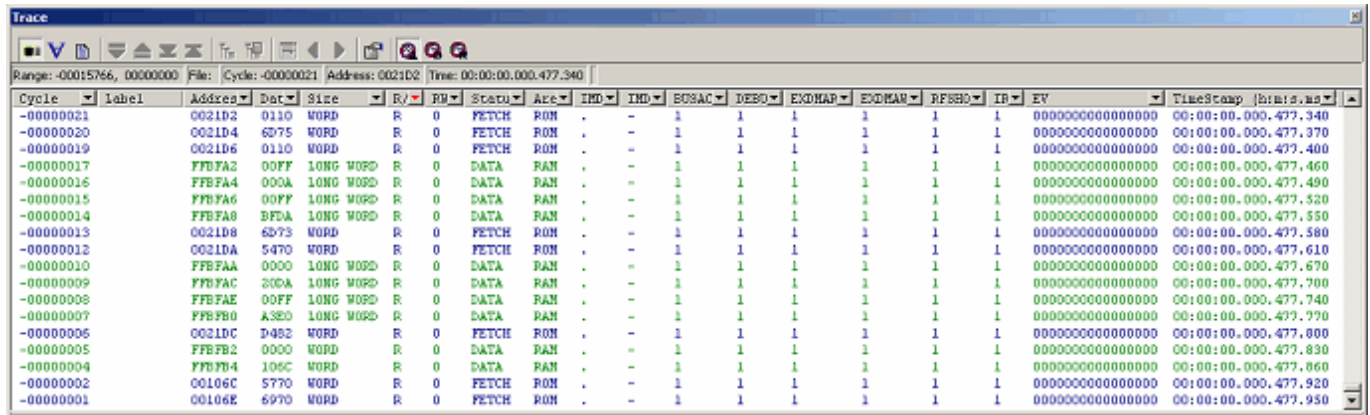

Figure 3.42 Trace window (Auto Filter)

Notes:

- (1) Filtering does not affect the trace memory, so that its contents remain intact.
- (2) Filtering is available for trace information regardless of whether the setting is fill until stop, fill until full or fill around TP.

3.18 Stack Trace Facility

Stack information can be used to find out which function called the function corresponding to the current PC value.

Set a software breakpoint in any line of the tutorial function by double-clicking on the corresponding row in the S/W Breakpoints column.

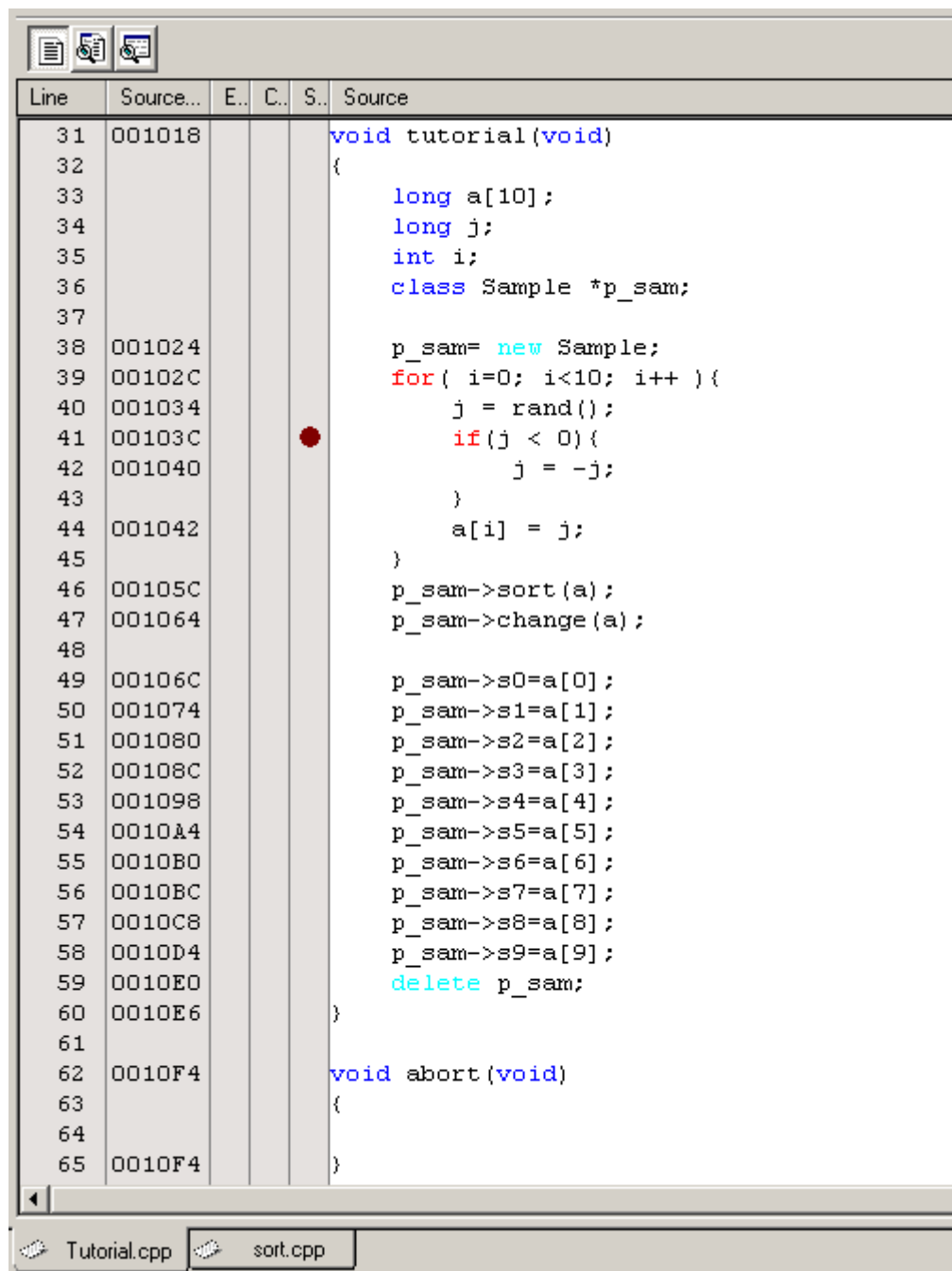

Figure 3.43 Editor window (setting a software breakpoint)

Choose Reset Go from the Debug menu.

After the break, choose Code → Stack Trace from the View menu to open the Stack Trace window.

Kind	Name	Value
F	tutorial()	{ 00103C }
F	main()	{ 00100C }
F	PowerON_Reset()	{ 000420 }

Figure 3.44 Stack Trace window

You will see that the current PC value is within the tutorial() function, and that the tutorial() function was called from the main() function.

Clear the software breakpoint that you set on a line of the tutorial function by again double-clicking on the corresponding row in the S/W Breakpoints column.

3.19 What Next?

In this tutorial, we have introduced to you several features of the E100 emulator and usage of the High-performance Embedded Workshop.

The emulation facilities of the E100 emulator provide for advanced debugging. You can apply them to precisely distinguish the causes of problems in hardware and software and, once these have been identified, to effectively examine the problems.

4. Preparation for Debugging

4.1 Starting the High-performance Embedded Workshop

Follow the procedure below to start the High-performance Embedded Workshop.

- (1) Connect the host machine, E100 emulator, and user system. Then turn on power to the E100 emulator and user system.
- (2) From Programs on the Start menu, choose Renesas -> High-performance Embedded Workshop -> High-performance Embedded Workshop.

The Welcome! dialog box shown below will appear.

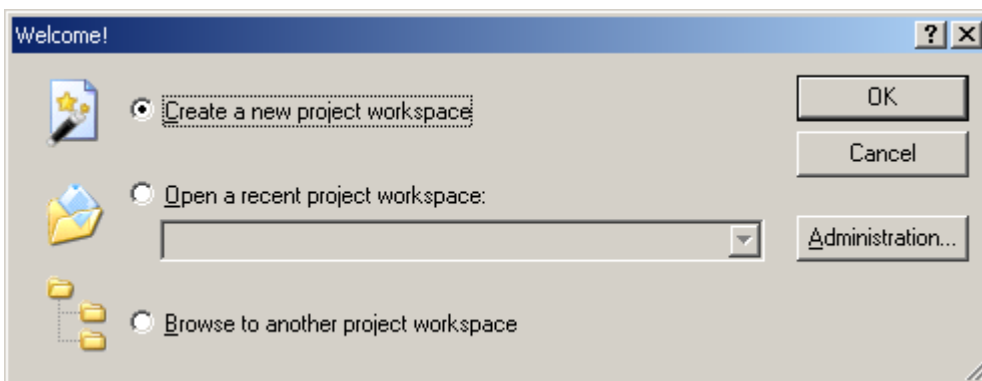

Figure 4.1 Welcome! dialog box

Select the startup method from among the following.

- Create a new project workspace
- Open a recently used project workspace
Select this option when you use an existing workspace.
The names of recently opened workspaces will be displayed.
- Browse for another project workspace
Select this option when you intend to use an existing workspace.
This option is available when there is no record of a recently opened workspace.

4.2 Creating a New Workspace (Toolchain Unused)

The procedure for creating a new project workspace differs according to whether you are using a toolchain or not.

Toolchains are not included with the E100 emulator. Toolchains can be used in environment in which the C/C++ compiler package is installed.

Follow the procedure below to create a new workspace.

(1) In the Welcome! dialog box, select the radio button with the caption "Create a new project workspace" and click on the OK button.

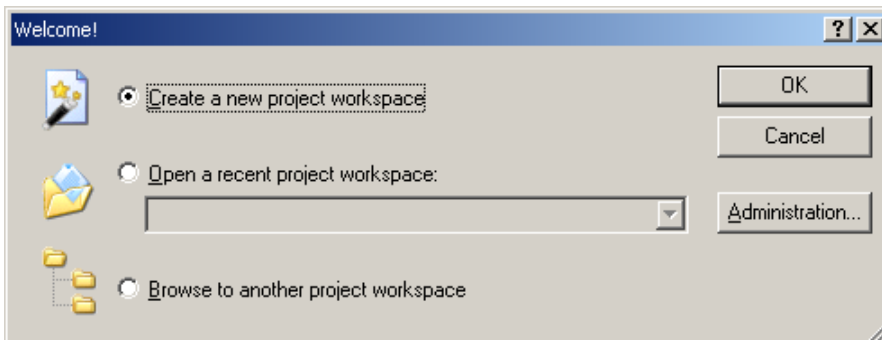

Figure 4.2 Welcome! dialog box

(2) The Project Generator will start.

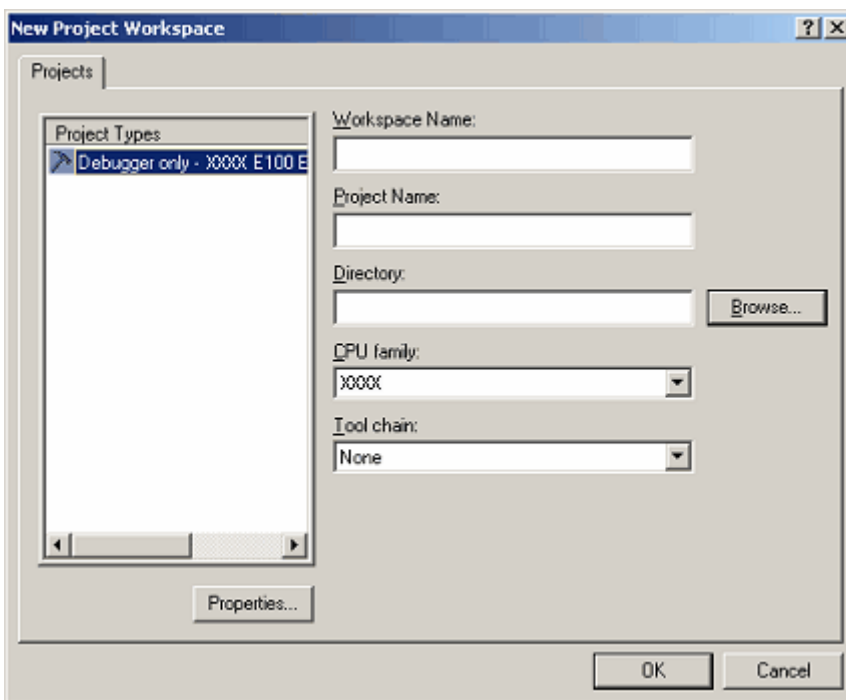

Figure 4.3 New Project Workspace dialog box

Workspace Name:	Enter a workspace name here.
Project Name:	Enter a project name here. You do not need to enter any name if you wish this to be the same as the workspace name.
Directory:	Enter the directory in which you want the workspace to be created. Alternatively, click on the Browse button and select a workspace directory from the dialog box.
CPU family:	Select the CPU family of the MCU you are using.

The other list boxes are used for setting up a toolchain. If no toolchains are installed, fixed information is displayed here. Click on the OK button.

(3) Select the target for debugging.

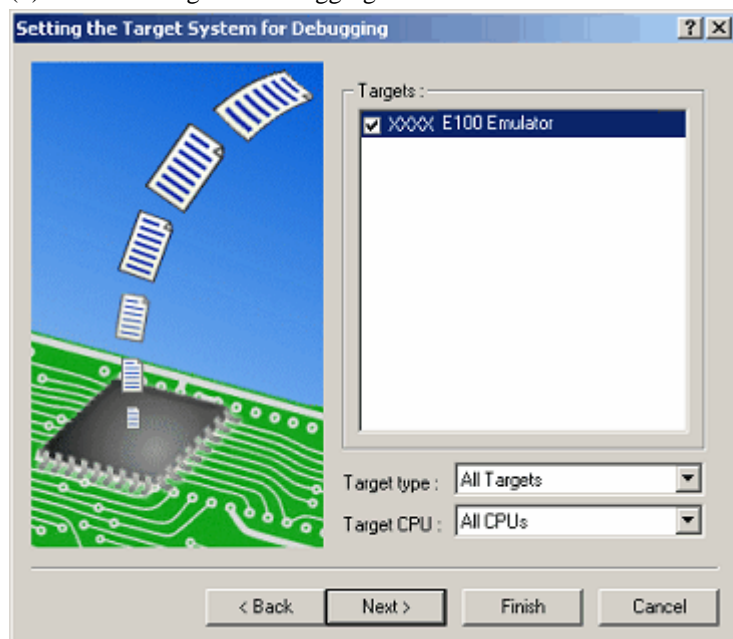

Figure 4.4 Setting the Target System for Debugging dialog box

Select the target platform you wish to use by placing a check mark in its checkbox and click on the Next button.

(4) Set a configuration name. Configuration refers to a file in which information on the state of the High-performance Embedded Workshop for use with target software rather than emulators is saved.

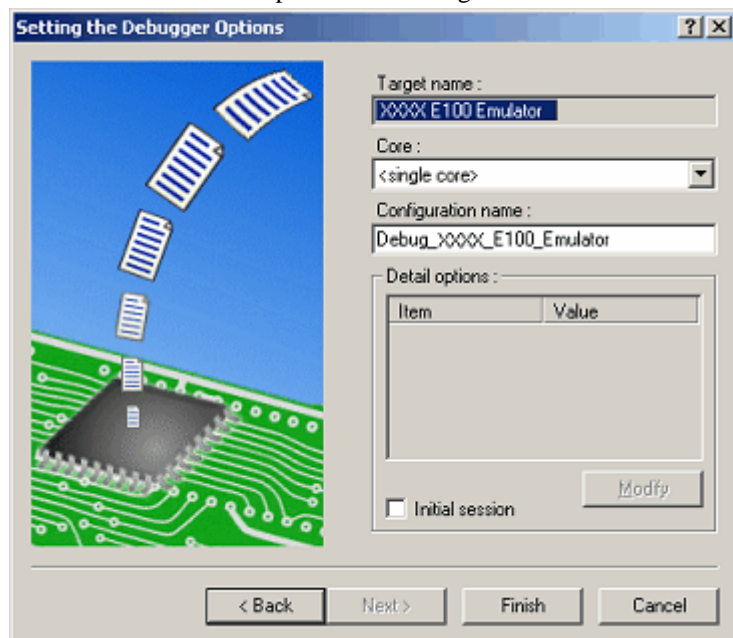

Figure 4.5 Setting the Debugger Options dialog box

If you have selected two or more target platforms, click on the Next button and then set a configuration name for each of the selected target platforms.

When you have finished setting the configuration names, emulator-related settings are completed.

Click on the Finish button, and the Summary dialog box will be displayed. Clicking on the OK button in this dialog box starts the High-performance Embedded Workshop.

(5) After starting the High-performance Embedded Workshop, connect the E100 emulator.

4.3 Creating a New Workspace (with a Toolchain in Use)

Follow the procedure below to create a new workspace.

(1) In the Welcome! dialog box, select the radio button titled “Create a new project workspace” and click on the OK button.

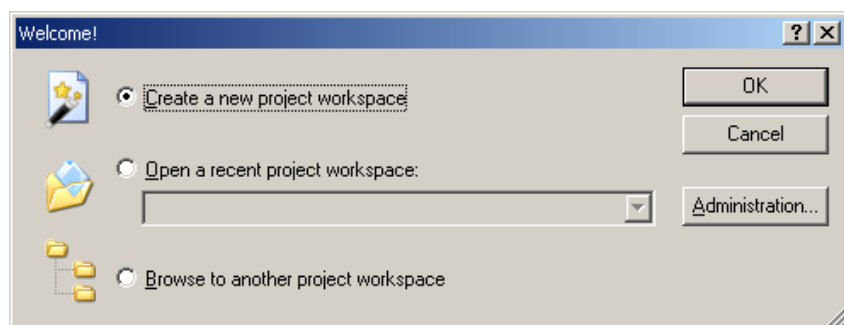

Figure 4.6 Welcome! dialog box

(2) The Project Generator will start.

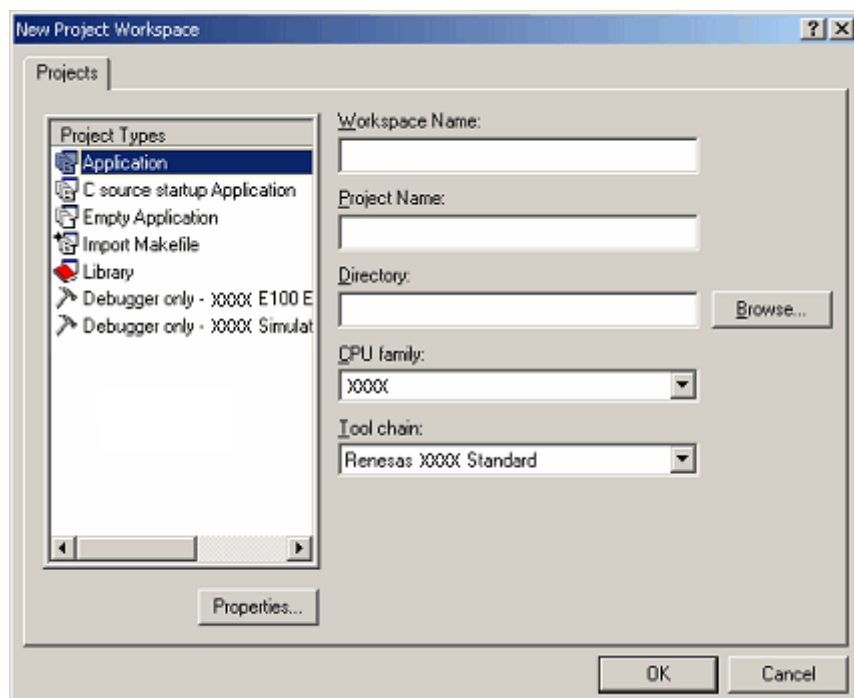

Figure 4.7 New Project Workspace dialog box

Workspace Name:	Enter a workspace name here.
Project Name:	Enter a project name here. You do not need to enter any name if you wish this to be the same as the workspace name.
Directory:	Enter a directory in which you want a workspace to be created. Alternatively, click on the Browse button and select a workspace directory from the dialog box.
CPU family:	Select the CPU family of the MCU you are using.
Toolchain:	To use a toolchain, select the appropriate toolchain here. If you do not use any toolchain, select None.

The other list boxes are used for setting up a toolchain. If no toolchains are installed, fixed information is displayed here. Click on the OK button.

(3) Set the CPU and options for the toolchain and make other necessary settings.

(4) Select the target for debugging.

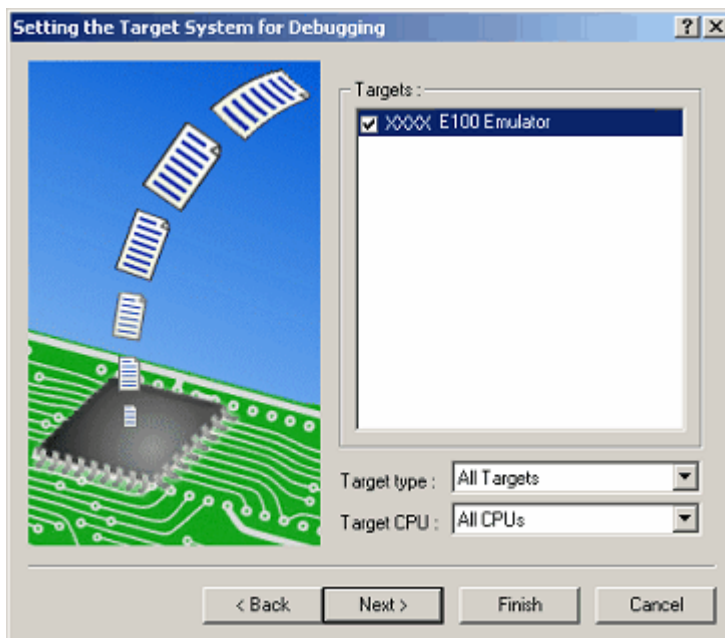

Figure 4.8 Setting the Target System for Debugging dialog box

Select the target platform you wish to use by placing a check mark in its checkbox and click on the Next button.

(5) Set a configuration name.

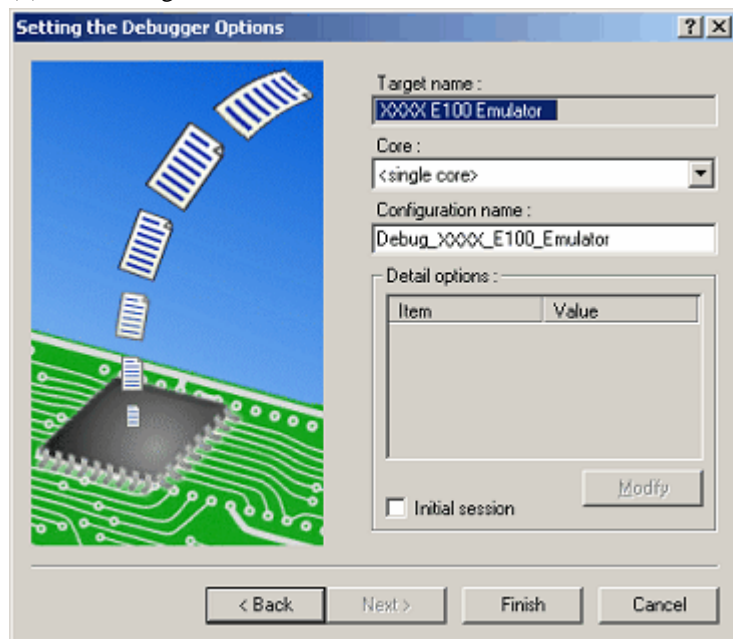

Figure 4.9 Setting the Debugger Options dialog box

If you have selected two or more target platforms, click on the Next button and then set a configuration name for each of the selected target platforms. When you have finished setting configuration names, emulator-related settings are completed. Click on the Finish button, and the Summary dialog box will be displayed. Clicking on the OK button in this dialog box starts the High-performance Embedded Workshop.

(6) After starting the High-performance Embedded Workshop, connect the E100 emulator.

4.4 Opening an Existing Workspace

Follow the procedure below to open an existing workspace.

- (1) In the Welcome! dialog box, select the radio button with the caption “Browse to another project workspace” and click on the OK button.

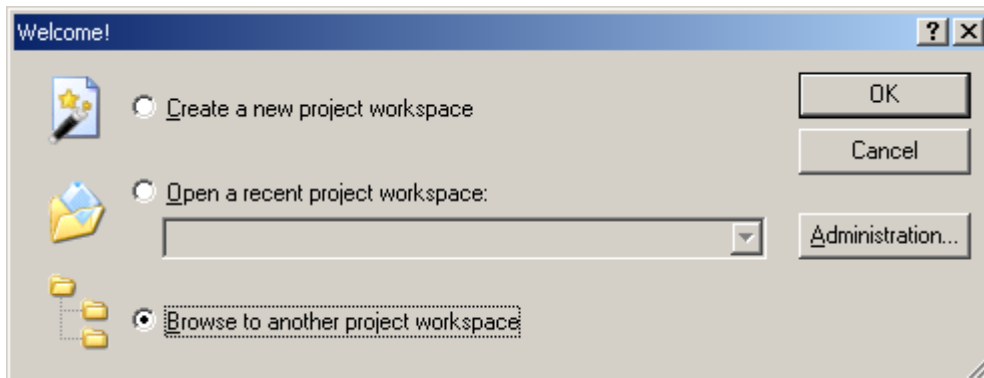

Figure 4.10 Welcome! dialog box

- (2) The Open Workspace dialog box shown below will appear.

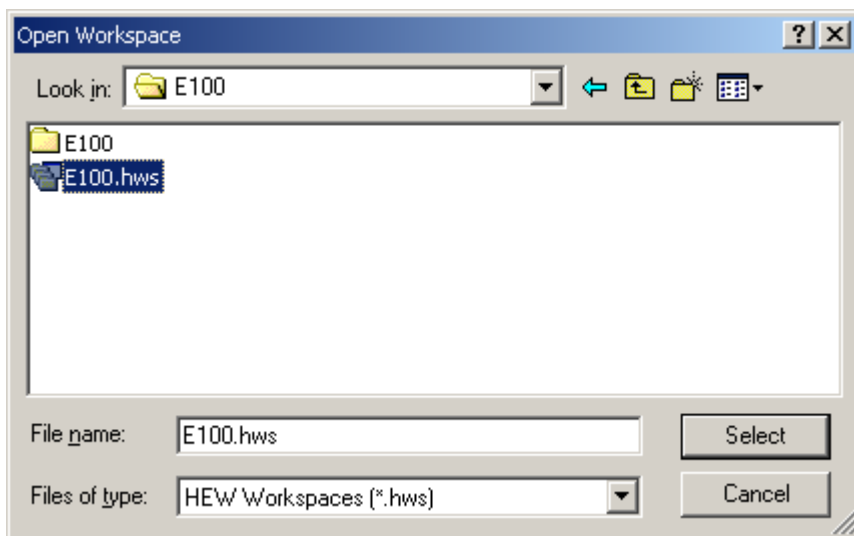

Figure 4.11 Open Workspace dialog box

Specify the directory in which the workspaces was created, select the workspace file (extension “.hws”), and click on the Select button.

- (3) The High-performance Embedded Workshop will start, and its state will be restored to the state at the time the selected workspace was saved. If the emulator was connected at the time, the workspace is automatically connected to the emulator. If the emulator was not connected but you want to connect it, refer to “4.5.1 Connecting the Emulator” (page 78).

4.5 Connecting the Emulator

4.5.1 Connecting the Emulator

The following methods for connecting the emulator are available.

(1) Making the emulator settings in booting-up before connection

Choose Debug Settings from the Debug menu to open the Debug Settings dialog box. In this dialog box, you can register download modules and the command chain to be automatically executed. When you are finished filling in the Debug Settings dialog box, the emulator will be connected.

(2) Loading a session file

Switching to a session file in which settings for emulator usage have been made in advance simplifies the procedure of connecting the emulator.

4.5.2 Reconnecting the Emulator

While the emulator is disconnected, you can reconnect it in one of the ways described below.

(1) Choose Connect from the Debug menu.

(2) Click on the Connect toolbar button .

(3) Enter the connect command in the Command Line window.

4.6 Disconnecting the Emulator

4.6.1 Disconnecting the Emulator

To disconnect the emulator while it is active, do so in one of the ways described below.

(1) Choose Disconnect from the Debug menu.

(2) Click on the Disconnect toolbar button .

(3) Enter the disconnect command in the Command Line window.

4.7 Quitting the High-performance Embedded Workshop

Choosing Exit from the File menu closes the High-performance Embedded Workshop.

Before it closes, a message box will be displayed asking you whether you want to save the session. To save the session, click on the Yes button.

4.8 Making Debugging-Related Settings

Register download modules, set up automatic execution of command line batch files, and set download options, etc.

4.8.1 Specifying a Module for Downloading

Choose Debug Settings from the Debug menu to open the Debug Settings dialog box.

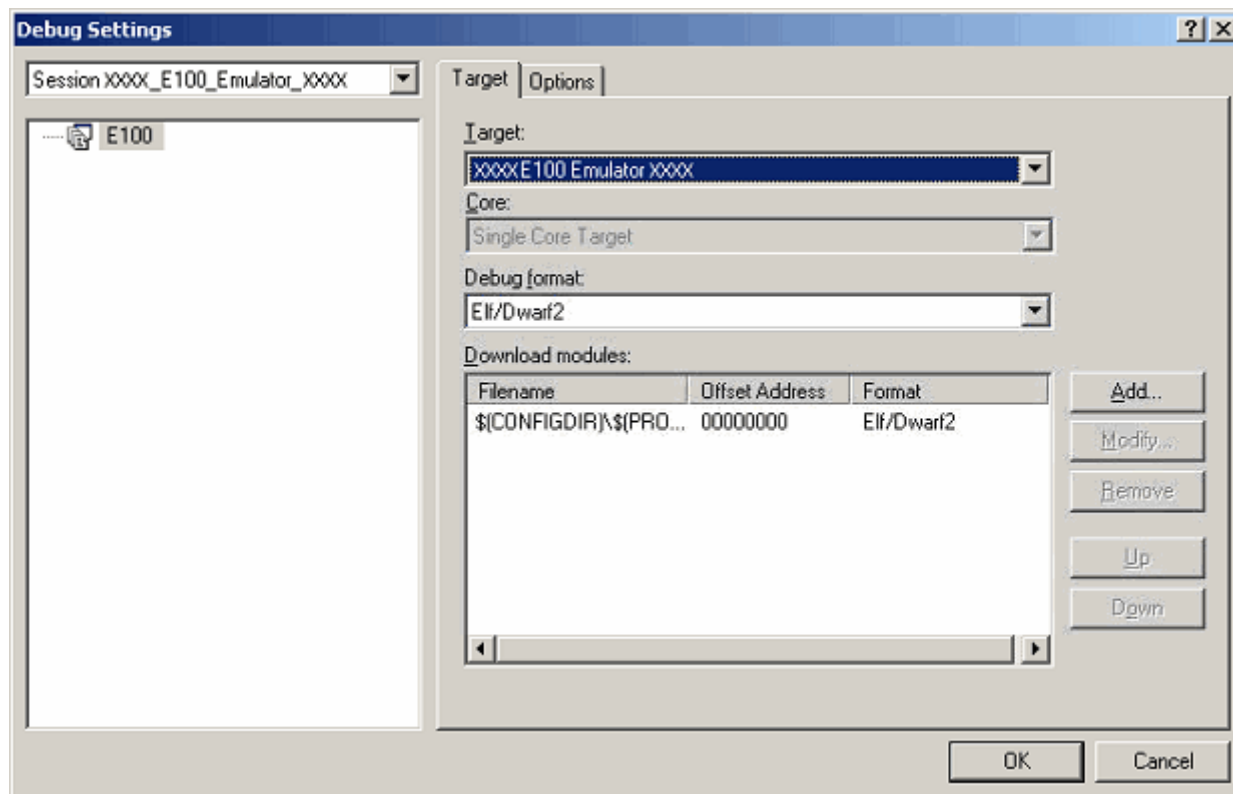

Figure 4.12 Debug Settings dialog box

In the Target drop-down list box, select the name of the product you want to connect.

In the Default debug format drop-down list box, select the format of the load module you want to download. Then register a module in the selected format in the Download modules list box.

CAUTION

At this point in time, no programs have been downloaded yet.

For details on how to download a program, refer to “5.2.1 Downloading a Program” (page 93).

4.8.2 Setting Up Automatic Execution of Command Line Batch Files

Click on the Options tab of the dialog box.

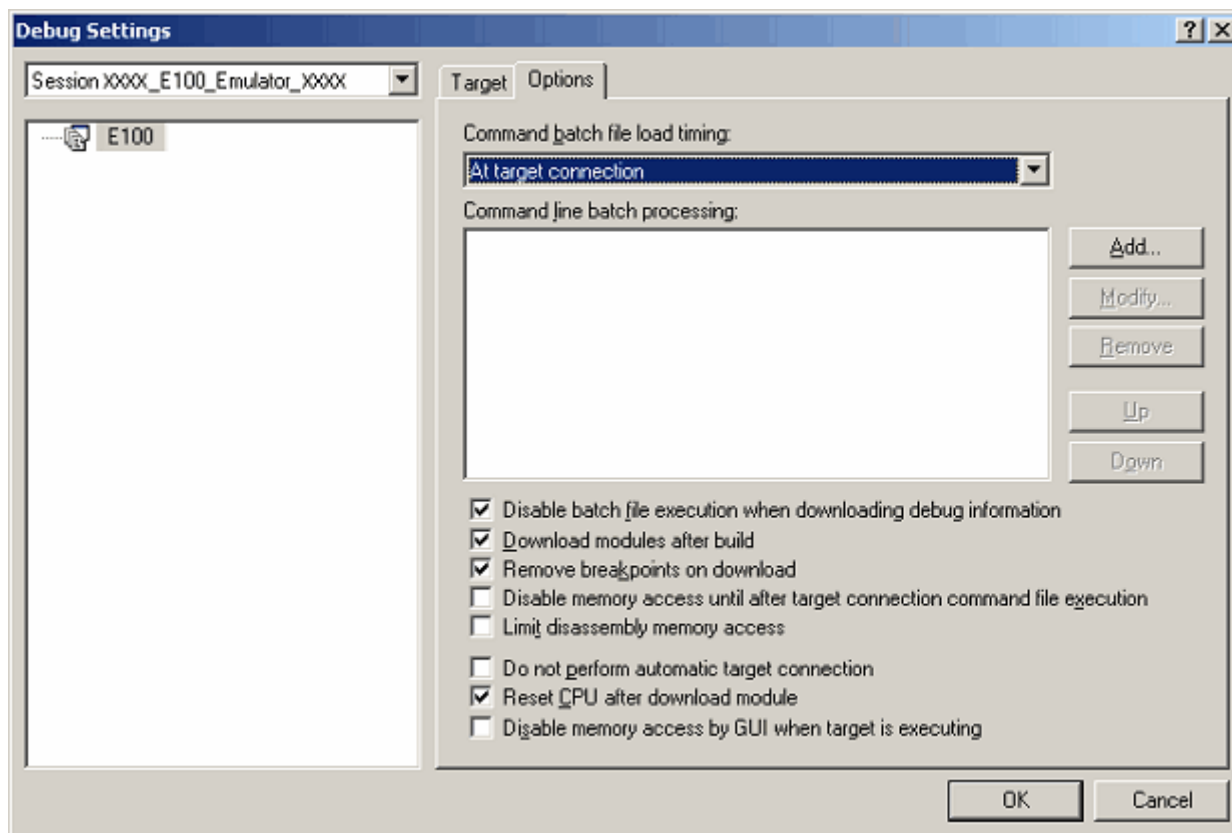

Figure 4.13 Debug Settings dialog box

Here, register a command chain to be automatically executed with the specified timing.

Select your desired timing from among the following four choices:

- When the emulator is connected
- Immediately before downloading
- Immediately after downloading
- Immediately after a reset

In the Command batch file load timing drop-down list box, select the timing with which you want a command chain to be executed.

5. Debugging Functions

The E100 emulator supports the functions listed in the table below.

Table 5.1 List of Debugging Functions

Item No.	Item		Specification	
1	Software break		4,096 points	
2	Event	Number of event points	Maximum number of effective points: 16	
		Content of event	Executed address detection	
			Data access detection	
			Interrupt generation or exit detection	
			External trigger detection	
Task ID	Can be set separately for each event			
Condition for number of times an event has occurred	Up to 255 times			
3	Exception detection		Violation of access protection	
			Reading from non-initialized memory areas	
			Stack access violation	
			Performance-measurement overflow	
			Realtime profile overflow	
			Trace memory overflow	
			Task stack access violation	
OS dispatch				
4	Hardware break	Hardware breakpoints	Event combination	
			Exception detection	
		Delay	Up to 65,535 bus cycles	
5	Trace	Trace size		
		Up to 4-M cycles		
		Trace mode	Fill until stop	Trace acquisition continues until the program stops running.
			Fill until full	Trace acquisition stops when trace memory becomes full.
			Fill around TP	Trace acquisition proceeds for a delay in cycles after the trace point has been reached.
			Repeat fill until stop	Information for a total of 512 cycles before and after each trace point are acquired, and this continues until the program stops.
			Repeat fill until full	Information for a total of 512 cycles before and after each trace point are acquired, and this continues until trace memory is full.
		Trace point	Event combination	OR, AND (cumulative), AND (simultaneous), subroutine, sequential and state transition
			Exception detection	See item No. 3
		Delay		Up to 4-M bus cycles
Extraction/deletion of trace data		Extracting or deleting data by specifying events - Between two events - Duration of an event - Duration of an event occurring in a subroutine Instruction accessing specific data		
6	Performance	Content of measurement		
		Measures maximum, minimum and average execution time in up to 8 sections and pass counts Timeout detection		
		Resolution	10 ns to 1.6 μs	
Measurement mode	Event combination	Between two events, Period of an event and Interrupt-disabled range between two events		
7	RAM monitor		512 bytes × 32 blocks - Shows last read/write accesses performed - Includes a facility to detect reading from non-initialized areas	
8	Realtime Profile		128 Kbytes × 8 blocks (1-Mbyte space)	
			Cumulative time and number of passes overflow detection	

Table 5.1 List of Debugging Functions (cont)

Item No.	Item	Specification
9	Coverage	C0 level code coverage 256 Kbytes × 8 blocks (2-Mbyte space) Address range and source file
		C0 + C1 level code coverage 128 Kbytes × 8 blocks (1-Mbyte space) Address range and source file
		Data coverage 64 Kbytes × 8 blocks (512-Kbyte space) Address range, section, and task stack
10	Trigger output (only when an external trigger cable* is connected) Note: The external trigger cable is optional.	Trigger pins 31 to 24: A specified pattern is output. Trigger pins 23 to 21: Output is in response to breakpoints being encountered. Trigger pins 20 to 16: Output is in response to a specified event.

5.1 Setting Up the Emulation Environment

When the emulator is connected, the Device setting and the Configuration properties dialog boxes are displayed. Here, select the general options associated with the emulator. Note that the target MCU to be debugged, etc. can only be set once each time the emulator is booted-up.

5.1.1 Emulator Settings During Booting up

While the emulator is booting up, the following three dialog boxes are opened in sequence.

(1) Device setting dialog box

Use this dialog box to select the target MCU and establish communication.

This dialog box can be re-opened by selecting Emulator -> Device setting from the Setup menu after the emulator has been booted up. In this case, however, be aware that changes of setting made after boot-up will not be reflected immediately but will be set as initial values when the emulator is reconnected.

(2) Configuration properties dialog box

This dialog box is opened after the Device setting dialog box. Use this dialog box to make settings related to the emulator and debugger functions.

This dialog box can be re-opened by selecting Emulator -> System from the Setup menu after the emulator has been booted up. Settings for certain options in this dialog box can be changed after boot-up. Those that can be changed are active while those that cannot are inactive (grayed out), but with their settings displayed.

(3) Connecting dialog box

This dialog box shows the progress of boot-up processing.

5.1.2 Setting Up the Target MCU

(1) Selecting the target MCU

On the Device page of the Device setting dialog box, specify the target MCU to be emulated. For details, refer to the hardware manual supplied with each product.

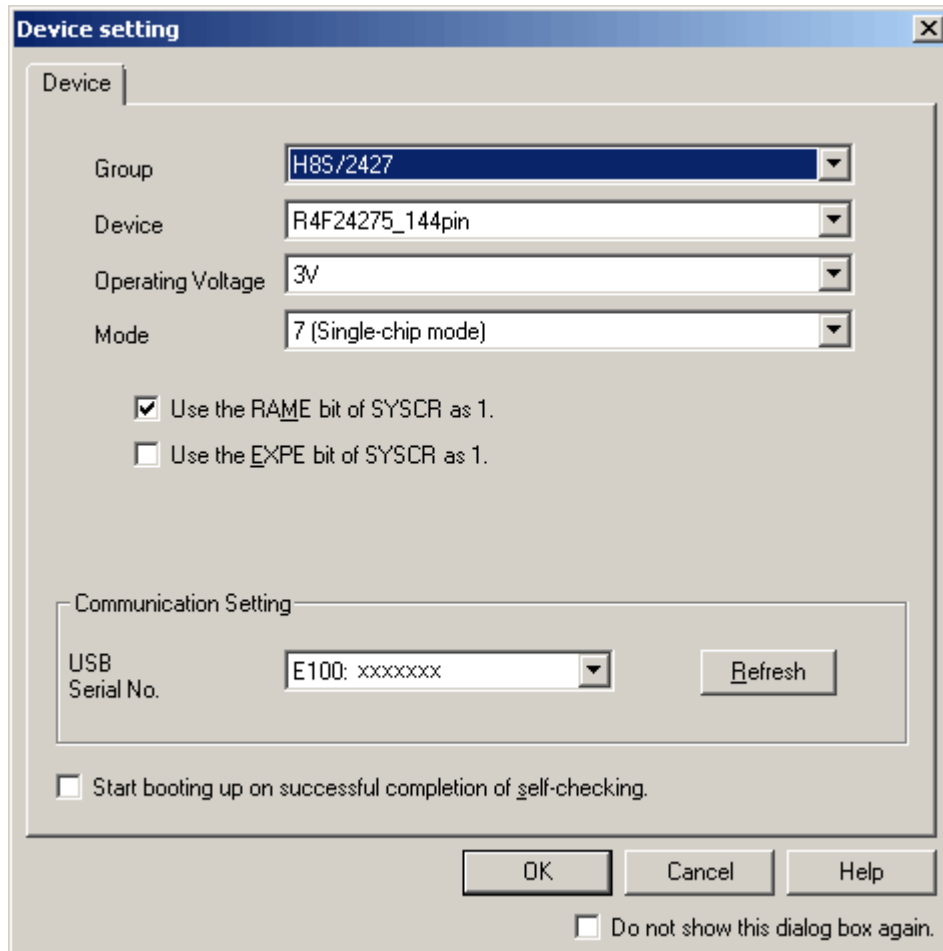

Figure 5.1 Device setting dialog box (Device page)

The target MCU you have set here cannot be changed after the emulator is connected. To change the target MCU, you need to disconnect and then reconnect the emulator.

(2) Selecting the operating voltage

Select the operating voltage. For details, refer to the hardware manual for the MCU in use.

(3) Selecting an operation mode

For details, refer to the hardware manual for the MCU in use.

(4) Usage with the RAME bit of SYSCR as 1

The state of the RAME bit in SYSCR is selectable. Select this checkbox when the target program is for execution with the RAME bit in SYSCR as 1. This option is only available for MCUs that have an RAME bit in SYSCR.

(5) Usage with the EXPE bit of SYSCR as 1

The state of the EXPE bit in SYSCR is selectable. Select this checkbox when the target program is for execution with the EXPE bit in SYSCR as 1. This option is only available for MCUs that have an EXPE bit in SYSCR.

(6) Setting up communications

You can select another target emulator for connection via USB.

The 'USB Serial No.' list box shows unique identifying information on the emulator connected via USB. Clicking on the Refresh button updates the information.

(7) Performing self-checking

If you click on the OK button with the 'Start booting up on successful completion of self-checking.' checkbox selected, hardware self-checking proceeds after connection to the emulator according to the communications condition you have set. The results are shown on completion of self-checking. If the results are normal, boot-up processing continues. If an error is found, boot-up processing stops.

5.1.3 Setting Up the System

On the System page of the Configuration Properties dialog box, specify the configuration of the emulator system as a whole. During the boot-up process, this dialog box appears after the Device setting dialog box.

Although it is possible to open this dialog box even after the emulator has been booted up, some items will be grayed-out since they cannot be changed.

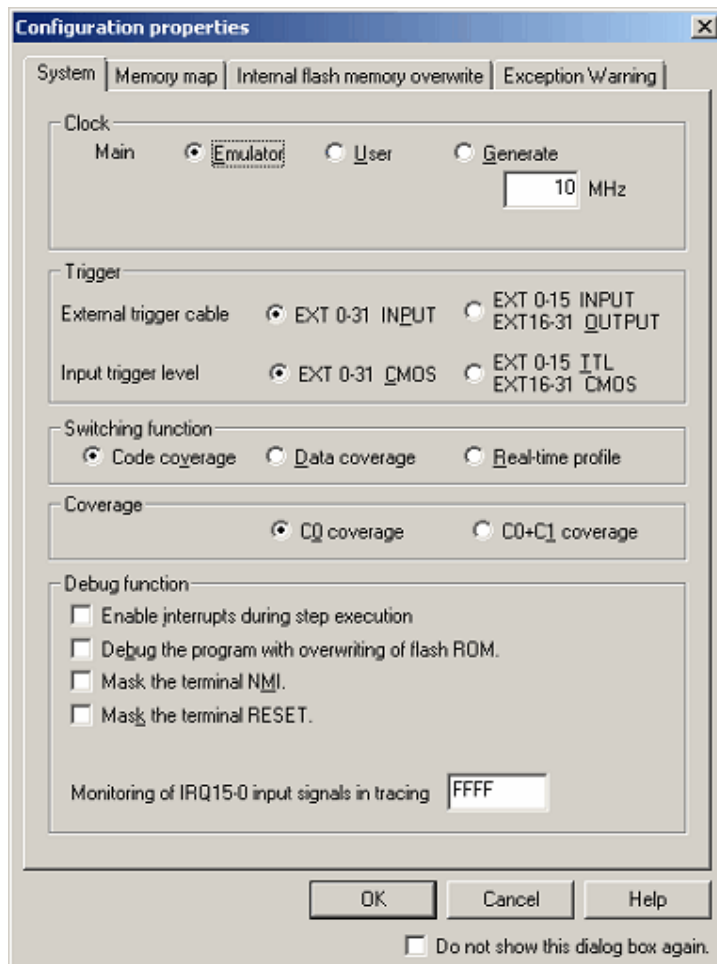

Figure 5.2 Configuration properties dialog box (System page)

(1) Selecting the operating clock

In the Clock section on the System page, select the sources of the clock signals supplied for the main clock and subclock. The main clock can be selected from among three choices: Emulator, User and Generate (by default, Emulator is selected). Select Emulator when the main clock is supplied from an internal source and User when the main clock is supplied from an external source. To use a user-defined clock, select Generate and enter the clock frequency in the text box. The clock frequency can be set in the range from 1.0 to 99.9 MHz in 0.1-MHz units. The clock frequency for Generate can be set only once each time the emulator is booted-up. Subclock options are only selectable for MCUs that support a subclock function. 'Emulator' or 'User' can be selected (by default, Emulator is selected).

CAUTION

The frequency accuracy for Generate is $\pm 5\%$. Please make sure that final evaluation is performed with a resonator or oscillator module mounted to generate the actual frequency for use on the target board.

(2) Selecting the direction of the external trigger cable

For the external trigger cable, select the direction of EXT pins 16–31 as input or output. EXT pins 0–15 are fixed as inputs. Select either of the following options:

- EXT 0–31 INPUT (default)
- EXT 0–15 INPUT, EXT 16–31 OUTPUT

(3) Selecting a trigger input level

Select CMOS level or TTL level as the trigger input level. Select either of the following options:

- EXT 0–31 CMOS (default)
- EXT 0–15 TTL, EXT 16–31 CMOS

(4) Selecting an exclusive function

The code coverage, data coverage and realtime profile functions cannot be used at the same time. Select one from among these functions.

Code coverage is selected by default.

The setting of this option can be changed even after the emulator has been booted up.

(5) Selecting a code-coverage mode

Select a code-coverage mode.

C0: Instruction coverage rate

C0 + C1: Instruction coverage rate and branch coverage rate

Up to 2 Mbytes of coverage information can be measured in C0-level coverage, while up to 1 Mbyte of coverage information can be measured in C0 + C1-level coverage. C0 coverage is selected by default.

This option can only be set in booting-up of the emulator and is only available when Code coverage has been selected in the Switching function section. If you wish to use the code coverage function after the emulator has started up, use this option to select a mode in advance.

(6) Enabling interrupts during stepped execution

Select whether interrupts should be enabled or disabled from the start of stepping until an instruction is executed. Interrupts are always accepted while a subroutine is being invoked by step-over or step-out execution.

(7) Debugging with overwriting of flash memory

Select this checkbox if you wish to allow rewriting of the contents of the flash memory during debugging.

(8) Masking the NMI pin

Select whether you want masking of input signals to the NMI pin of the target system.

(9) Masking the RESET pin

Select whether you want masking of input signals to the RESET pin of the target system.

(10) Enable or disable IRQ input signals

Specify the hexadecimal number for the pattern of bits that corresponds to the user IRQ signals (IRQn) that you wish to monitor.

0: Disables monitoring of IRQn

1: Enables monitoring of IRQn

n = 15 to 0.

The default value is FFFF.

5.1.4 Setting up the Memory Map

The Memory map page of the Configuration properties dialog box allows the user to assign up to four blocks of emulation memory.

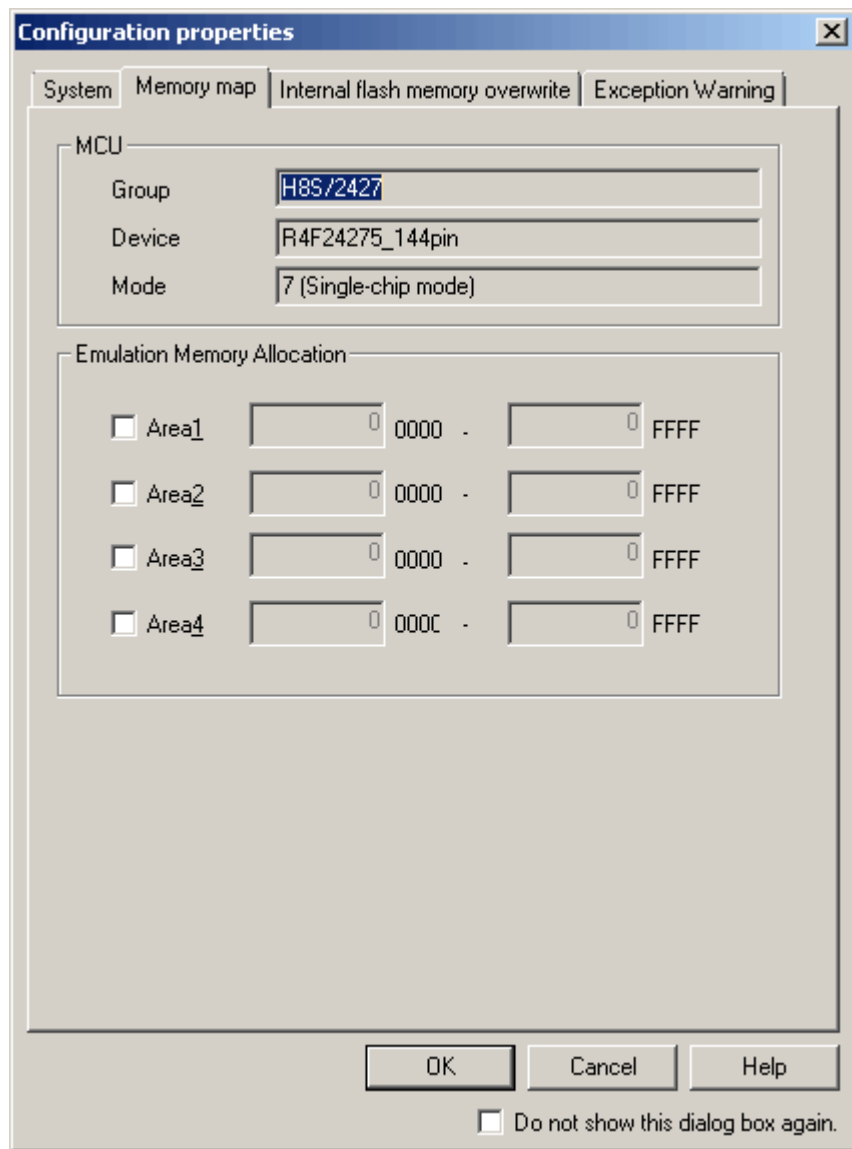

Figure 5.3 Configuration properties dialog box (Memory map page)

The MCU currently in use is automatically displayed in the 'MCU' section. This selection is not modifiable on the Memory map page.

- Assign emulation memory to external space

Up to four blocks of emulation memory can be allocated to external space. Select the checkboxes for the areas you wish to use and specify the addresses where they start and end. Note that the 16 lower-order bits of the addresses are fixed because the blocks are only specifiable in 128-Kbyte units.

5.1.5 Setting for Overwriting Blocks of the Flash ROM

The Internal flash memory overwrite page of the Configuration properties dialog box allows you to specify whether or not individual blocks of flash ROM should be overwritten.

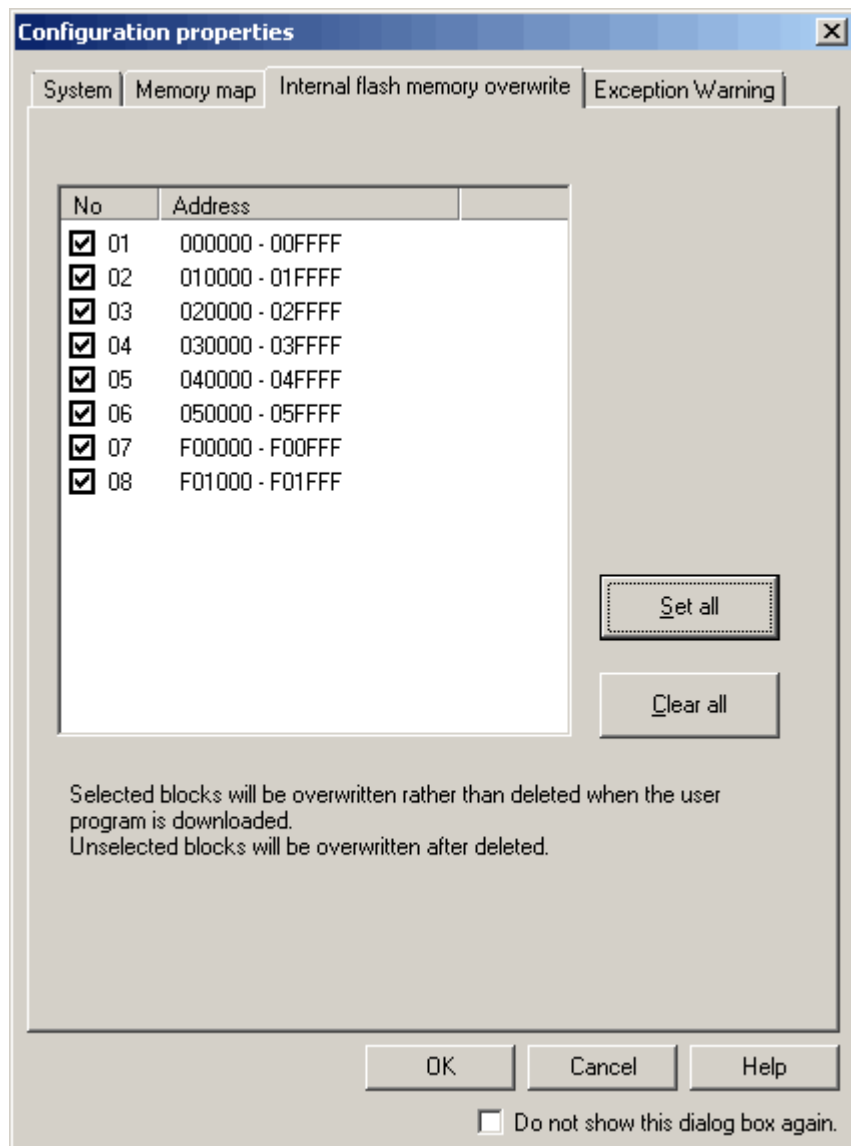

Figure 5.4 Configuration properties dialog box (Internal flash memory overwrite page)

Settings for all blocks are automatically shown in the list according to the information on the target MCU. When a checkbox is selected, the block will be overwritten rather than deleted when the user program is downloaded.

5.1.6 Settings to Request Notification of Exceptional Events

The Exception Warning page of the Configuration properties dialog box allows you to select whether or not to display warnings in the Status window and as a balloon on the status bar when exceptional events occur.

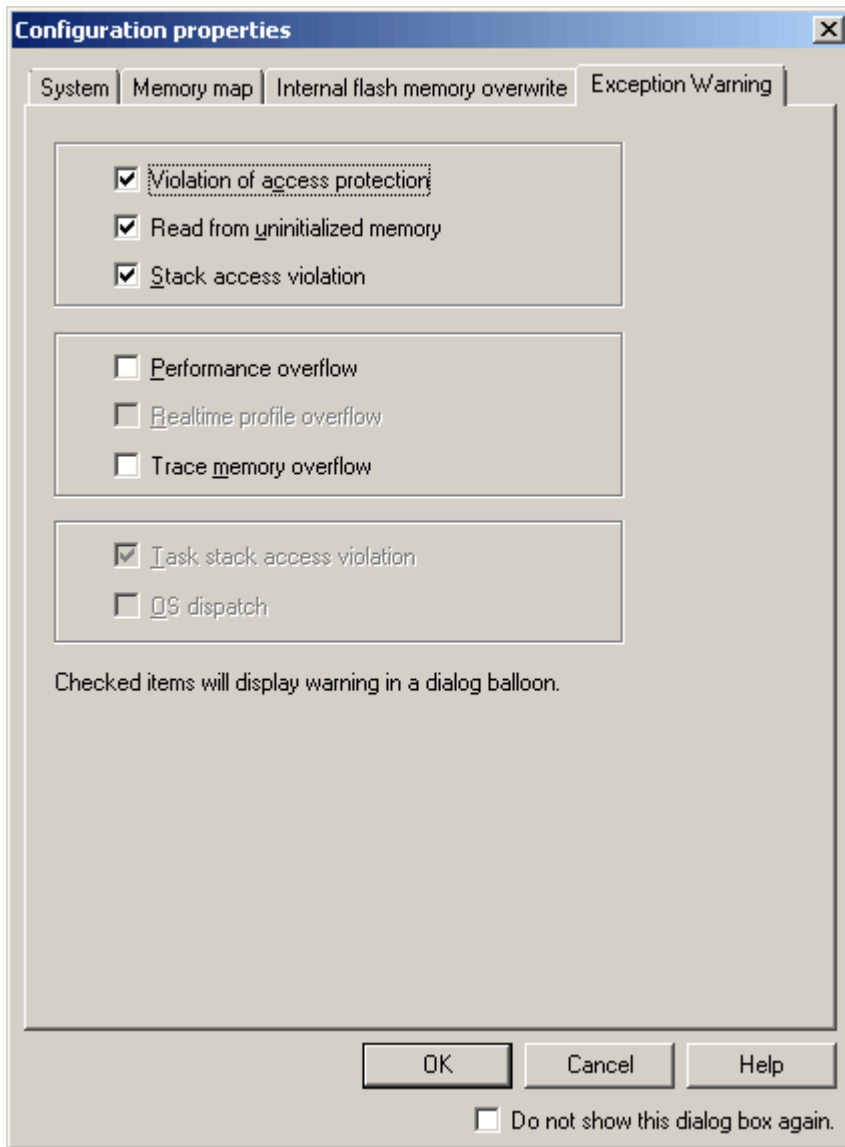

Figure 5.5 Configuration properties dialog box (Exception Warning page)

The 'Violation of access protection', 'Read from uninitialized memory' and 'Stack access violation' checkboxes are initially selected.

When a load module that includes an OS has been downloaded, the 'Task stack access violation' checkbox is also initially selected.

Other items are non-selected by default.

If you deselect a checkbox, the corresponding item will appear as '-' in the Status window.

5.1.7 Viewing the Progress of Boot-Up Processing

You can check the progress of boot-up processing in the Connecting dialog box.

This dialog box appears when boot-up processing is started and remains open until it is completed.

As long as display of the Device setting and the Configuration properties dialog boxes continues, you cannot manipulate this dialog box.

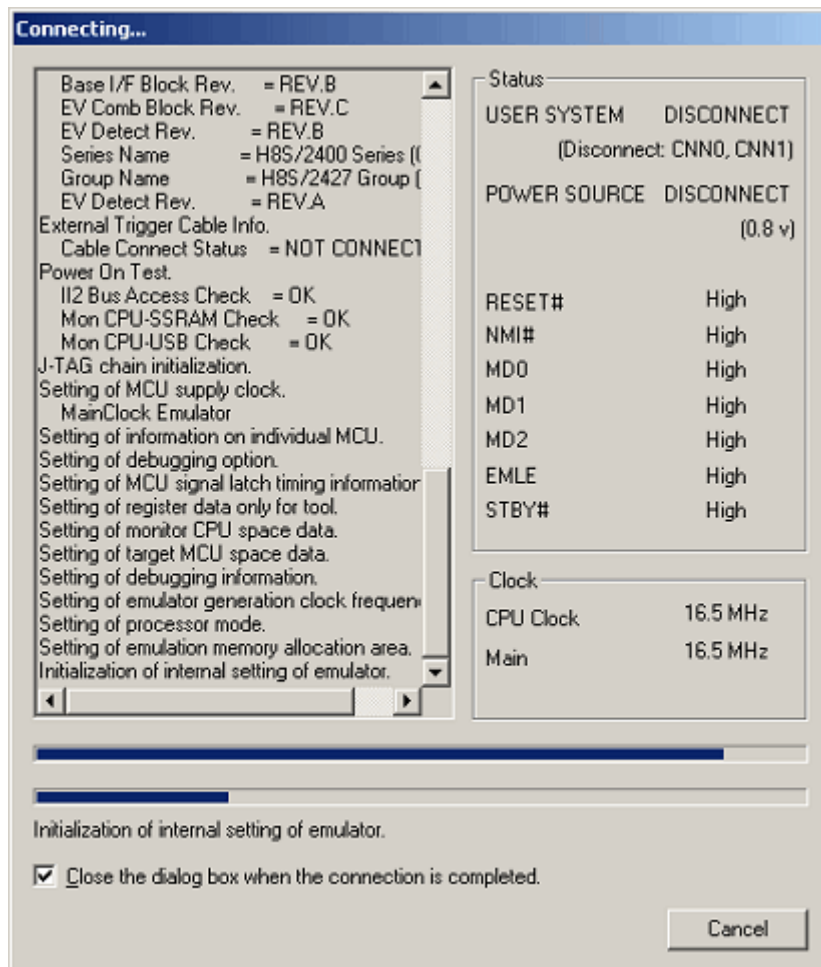

Figure 5.6 Connecting dialog box

(1) Description of progress

The progress history box on the left-hand side of the dialog box shows the history of progress.

The information shown here is saved in a bug report. To check the contents of the bug report, select Technical Support -> Create Bug Report from the Help menu.

(2) Display of pin states

The pin states are updated when you close the Configuration properties dialog box.

A warning will be shown in the progress history box if the pin states do not match the settings made in the Device setting dialog box.

(3) Display of states of clock signals

This information will be updated on completion of processing for the clock settings.

Only information on the clock signals that are actually operating is shown here.

(4) State of progress as progress bars

The upper progress bar shows the state of progress through the overall process of booting up.

The lower progress bar shows the state of progress through the current part of the process of booting up.

The name of the current part of the overall process is shown under the progress bar.

(5) Canceling the connection

Click on the Cancel button to cancel the process of booting up.

5.2 Downloading a Program

5.2.1 Downloading a Program

Download the load module to be debugged.

To download a program, choose Download from the Debug menu and select a desired load module or right-click on a load module under Download modules of the Workspace window and then choose Download from the popup menu.

CAUTION

Before a program can be downloaded, you must have it registered as a load module in the High-performance Embedded Workshop. For details on how to register load modules, refer to “4.8 Making Debugging-Related Settings” (page 79).

5.2.2 Viewing the Source Code

Select either of the following ways to view the source code.

- Double-click on the name of the source file in the Workspace window.
- Right-click on the name of the source file and choose Open from the popup menu.

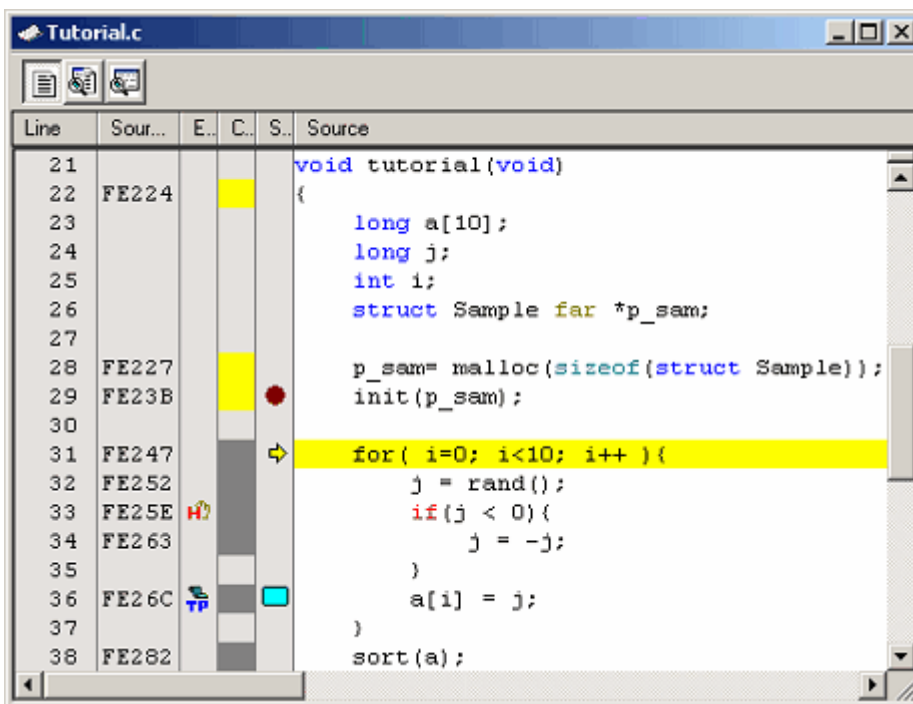

Figure 5.7 Editor window

The columns listed below are to the left of the Source column.

This column shows the line numbers of lines in the source file.



(2) Source Address column

When a program is downloaded, this column shows the addresses that correspond to the lines of the current source file. This function is convenient for determining values for the PC and where to set breakpoints.

(3) Event column

This column shows the following:

Table 5.2 Icons in the Event column

	Hardware breakpoint is set
	Trace point (fetch condition) is set

A hardware breakpoint can be set by double-clicking in the Event column.

A trace point is only displayed when a fetch condition has been set.

[*] after the title on the title bar of the Hardware break, Trace conditions and Performance Analysis Conditions dialog boxes shows that a setting is being edited. You cannot change the settings from the Event column of the Editor window while editing is in progress.



(4) Code Coverage column

This column graphically shows the C0 code coverage information.

(5) S/W Breakpoints column

This column shows the following:

Table 5.3 Icons in the S/W Breakpoints column

	Bookmark
	Software break
	PC position

5.2.3 Turning Columns in All Source Files off

(1) From the Editor window

1. Right-click in the Editor window and choose Define Column Format from the popup menu.
2. The Global Editor Column States dialog box will be displayed.

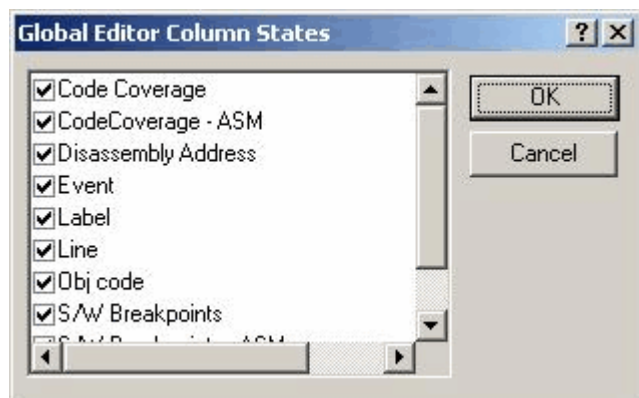

Figure 5.8 Global Editor Column States dialog box

3. Deselect the checkboxes of columns you want to turn off. Click the OK button, and the new settings you have made will take effect.

5.2.4 Turning Columns off for One Source File

(1) From the Editor window

1. Right-click in the Editor window and choose Columns from the popup menu.
2. A cascaded menu will be displayed. A check mark is to the left of the names of currently enabled columns.

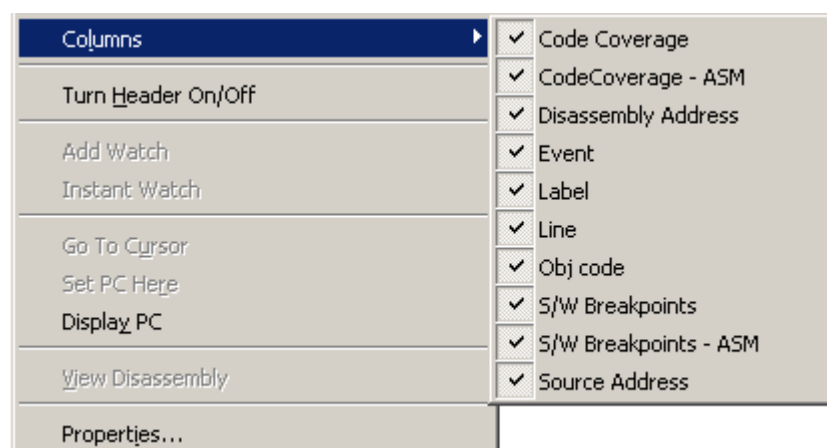

Figure 5.9 Popup menu window

3. Clicking on a column name toggles the setting between enabling and disabling of the column.

5.2.5 Viewing Assembly Language Code

While a source file is open, click the right mouse button in the Editor window and choose View Disassembly from the popup menu. The Disassembly window will be displayed.

The first address shown in the Disassembly window corresponds to the cursor position in the Editor window.

You can also use the View Disassembly button in the Editor window to view code produced by disassembly.

If there is no source file, you can still view the disassembly by one of the following methods.

- Click on the Disassembly toolbar button .
- Choose Disassembly from the View menu.
- Use the “Ctrl + D” shortcut keys.

In this case, the Disassembly window opens with a listing from the position currently indicated by the PC.

The emulator also supports a mixed mode as an optional way to show all source lines from the address where disassembly started. To view disassembly code in mixed mode, click the View mixed mode button.

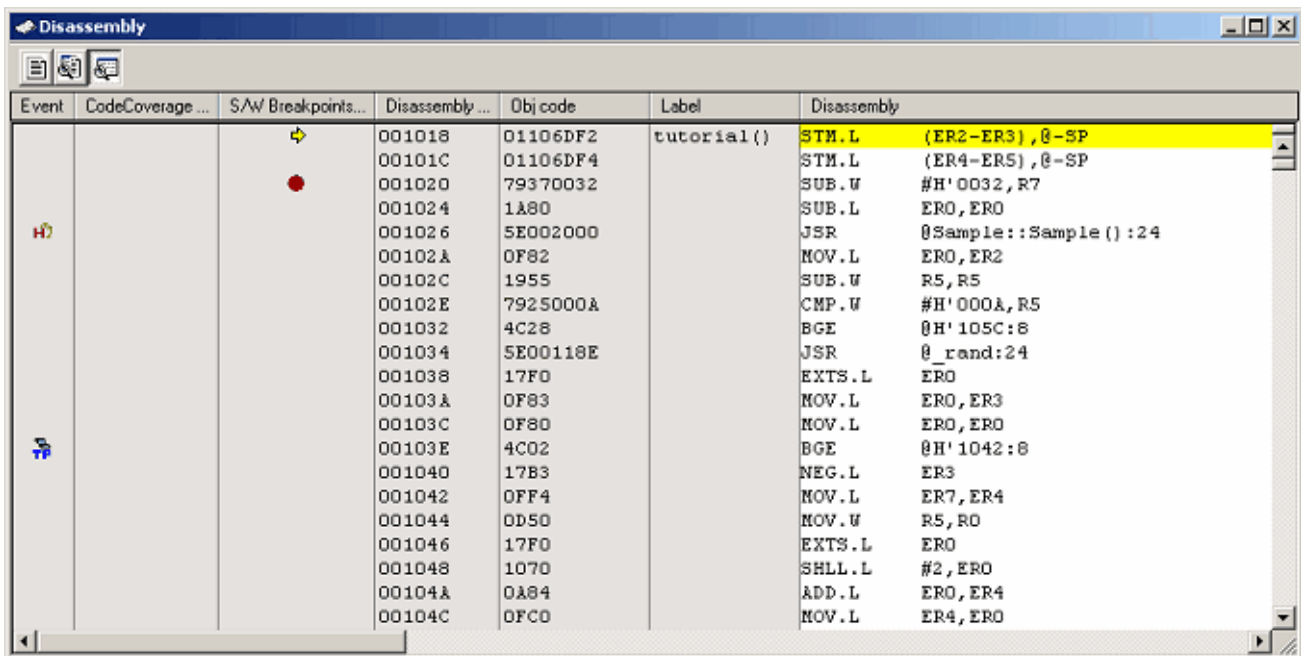



Figure 5.10 Disassembly window

The columns listed below are to the left of the Disassembly column.

(1) Event column

This column shows the following:

Table 5.4 Icons in the Event column

	Hardware breakpoint
	Trace point (fetch condition)

A hardware breakpoint can be set by double-clicking in the Event column.

A trace point is only displayed when a fetch condition has been set.



(2) Code Coverage - ASM column

This column graphically shows the C0 code coverage information.

(3) S/W Breakpoints - ASM column

This column shows the following:

Table 5.5 Icons in the S/W Breakpoints – ASM column

	Software break
	PC position

(4) Disassembly Address column

This column shows the address of the machine code corresponding to the disassembly. Double-clicking in this column brings up the Set Address dialog box. Enter the address where you want the display of disassembly code to start in this dialog box.

(5) Obj code column

This column shows the object code.

(6) Label

This column shows labels. This column is not usable if no module has been downloaded.

5.2.6 Correcting Assembly Language Code

Double-click on the instruction you want to correct in the Disassembly window or choose Edit from the popup menu. The Assembler dialog box will open. Use this dialog box to correct the assembly-language code.



Figure 5.11 Assembler dialog box

The dialog box shows the address, instruction code and mnemonic of the selected instruction.

Enter a new instruction (or edit the old instruction) in the Mnemonic edit box. When you have finished, hit the Enter key. The value in memory is overwritten by the new instruction code, and the pointer is moved to the next instruction.

Click on the OK button to overwrite the current value in memory with the new instruction code and close the dialog box.

CAUTION

The assembly-language code shown in the Disassembly window and the Assembler dialog box is based on the data currently in memory. When you modify data in memory, the new assembly-language code is shown in the Disassembly window and the Assembler dialog box. However, the source file being displayed in the Editor window remains unchanged, even if it includes assembly-language code.

5.3 Viewing Memory Data in Real Time

5.3.1 Viewing Memory Data in Real Time

Use the RAM Monitor window to monitor data in memory while the user program is running.

The RAM monitoring function permits recording and inspection of the data in an area of memory for which monitoring has been assigned and the states of access in real time without obstructing execution of the user program.

The RAM Monitor window shows the access states (read, written, non-initialized or not inspected) in different colors.

(1) Allocating an area for RAM monitoring

A 16-Kbyte RAM monitoring area is provided.

This RAM monitoring area can be allocated to a desired contiguous address range or up to 32 blocks of 512 bytes.

By default, a maximum of 16 Kbytes of space from the first address of the internal RAM is allocated as the RAM monitoring area.

(2) Monitor display

Access states are indicated by different background colors according to the access attribute as listed below (the background colors are customizable).

The access attributes “read” and “written” indicate the last access to each memory location.

To view detected errors, choose Error Detection Display from the popup menu. In this case, the information on reading and writing is not displayed.

Table 5.6 Access attribute and background color

Access attribute		Background color
Read		Green
Written		Red
Error detected	Non-initialized memory (the location has been read but nothing has been written to it yet)	Yellow
	Non-inspected memory (a value has been written to the location but it has not been read)	Sky blue
No access		White

CAUTION

The contents of the RAM Monitor window are acquired from bus access. Therefore, changes made to memory by access that was not through the user program (e.g. writing to memory directly from external I/O) are not reflected in the RAM Monitor window.

(3) Detecting reading from non-initialized areas

If a memory location is read but nothing has been written to that location, the emulator detects “a non-initialized area” and indicates the error.

To view errors of this type, choose Error Detection Display from the popup menu.

Non-initialized memory locations are shown against a yellow background.

Errors of this type can be detected as exceptional events and used as conditions of hardware breakpoints and trace points (also refer to “5.14 Detecting Exceptional Events” (page 186)).

(4) Detecting non-inspected areas

If a memory location has been initialized but has not been read, the emulator detects this as “a non-inspected area” and indicates the error.

To view errors of this type, choose Error Detection Display from the popup menu.

Non-inspected memory locations are shown against a sky blue background.

5.3.2 Setting the Update Interval for RAM Monitoring

Choose Update Interval Setting from the popup menu of the RAM Monitor window. The Update Interval Setting dialog box shown below will appear.

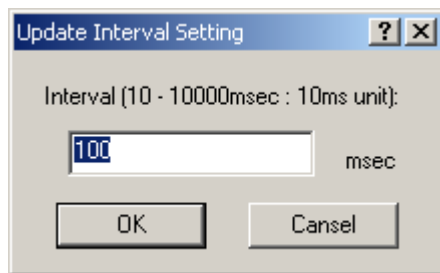

Figure 5.12 Update Interval Setting dialog box

A separate Update Interval can be specified per RAM Monitor window.
The initial value is 100 ms.

5.3.3 Clearing RAM Monitoring Access History

Choose Access Data Clear from the popup menu of the RAM Monitor window. The history of all access to the RAM monitoring area will be cleared.

CAUTION

If clearing proceeds while the user program is being executed, the realtime characteristic of execution may be lost because clearing produces a memory dump.

5.3.4 Clearing RAM Monitoring Error Detection Data

Choose Error Detection Data Clear from the popup menu of the RAM Monitor window. All information on the detected errors in the RAM monitor area will be cleared.

5.4 Viewing the Current Status

5.4.1 Viewing the Emulator Status

To find out the current status of the emulator, open the Status window.

To open the Status window, choose CPU -> Status from the View menu, or click on the View Status toolbar button .

The information shown in this window is not updated while the program is running.

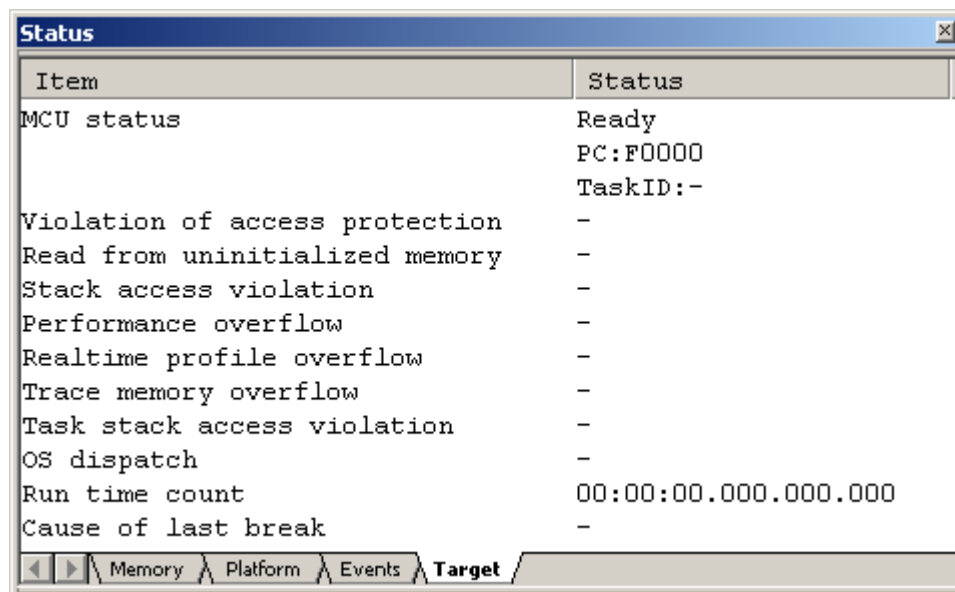

Figure 5.13 Status window

The Status window has the following four sheets.

Table 5.7 Sheets of the status window

Sheet	Description
Memory	Shows information on memory resources.
Platform	Shows information on the emulator and debugging.
Events	Shows information on events.
Target	Shows information on the target MCU.

5.4.2 Viewing the Emulator Status in the Status Bar

The status of the emulator can be displayed in the status bar.

Right clicking on the status bar brings up a list of the available items. Check the items you want to view in the status bar.

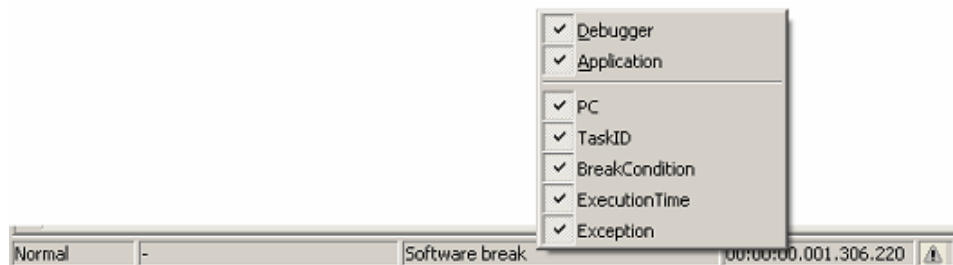

Figure 5.14 Status bar

Table 5.8 Items regarding emulator status shown in the status bar

Item	Description
PC	PC value During execution: PC value During a break: Normal
Task ID	Task ID, task entry label
BreakCondition	Source of a break in the user program
ExecutionTime	Result of time measurement
Exception	Whether or not an exceptional event has occurred

(1) When more than one break source is present

When you click on the status bar indicating the source of a break (“Some factors exist” when there is more than one), a balloon appears.

Read the contents of the balloon to check the source of the break.



Figure 5.15 Checking the source of a break

(2) When an exceptional event has occurred

When an exceptional event has occurred, a warning is displayed in a status bar balloon.

However, exceptional events of types that are not selected on the Exception Warning page of the Configuration properties dialog box are not shown.

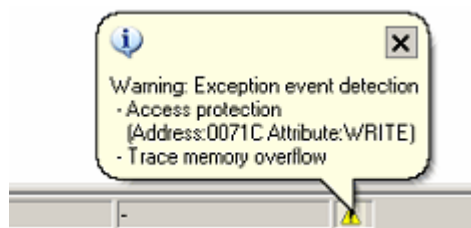

Figure 5.16 Example of warning display when exceptional events have occurred

5.5 Periodically Reading Out and Showing the Emulator Status

5.5.1 Periodically Reading Out and Showing the Emulator Information

To find out about changes in emulator information whether the user program is running or idle, use the Extended Monitor window.

The extended monitor function only monitors the signals output from the user system or MCU, so it does not affect execution of the user program.

To open the Extended Monitor window, choose CPU -> Extended Monitor from the View menu, or click on the Extended

Monitor toolbar button .

The displayed items are updated at an interval of about 1,000 ms during user program execution or about 5,000 ms during a break.

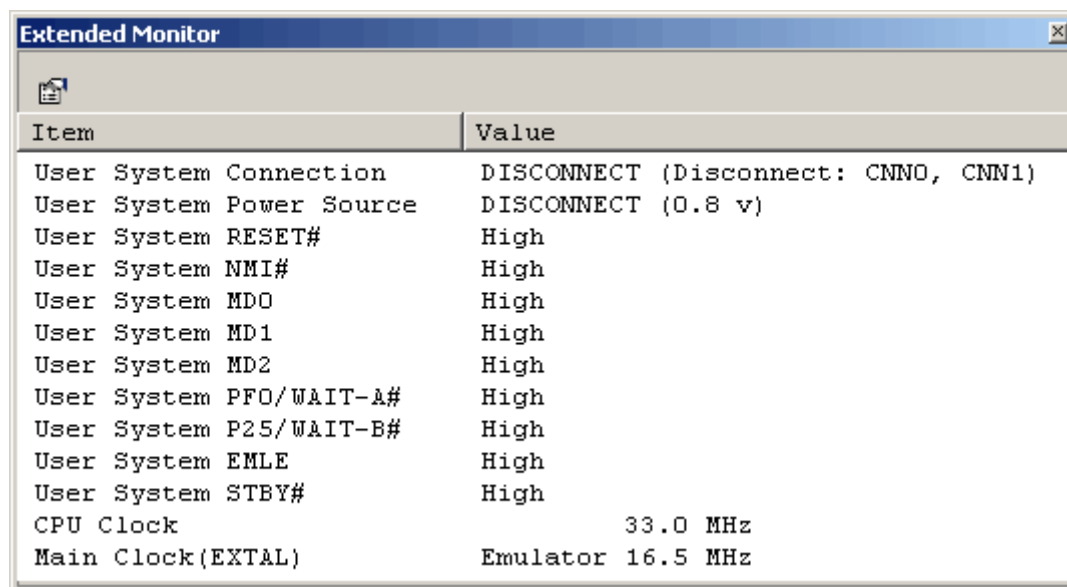

Figure 5.17 Extended Monitor window

5.5.2 Selecting the Items to Be Displayed

Choose Properties from the popup menu of the Extended Monitor window. The Extended Monitor Configuration dialog box will be displayed.

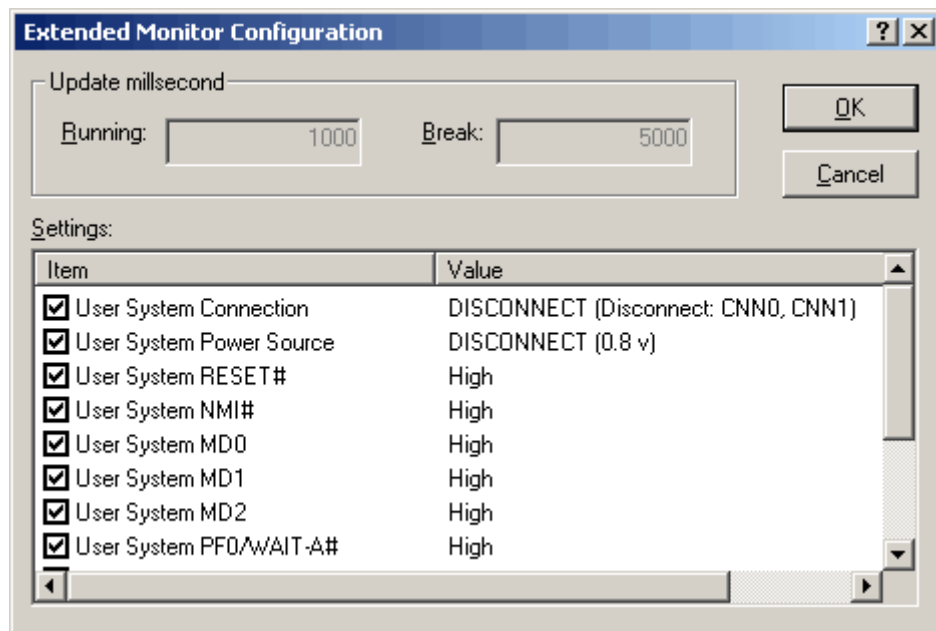

Figure 5.18 Extended Monitor Configuration dialog box

This dialog box allows you to select items to be shown in the Extended Monitor window.

5.6 Using Software Breakpoints

5.6.1 Using Software Breakpoints

In a software break, the instruction code at a specified address is replaced with a BRK instruction, which causes the user program to stop running by generating a BRK interrupt. In that sense, this is a pre-execution break function.

Up to 4096 breakpoints can be set.

If multiple software breakpoints are set, program execution breaks when it arrives at any of the breakpoints reached.

(1) When stopped at a software breakpoint

When the program you have created is run and arrives at an address you have set as a software breakpoint, the program stops and the message “Software Break” is displayed on the Debug sheet of the Output window. At this time, the Editor or Disassembly window is updated, and the position where the program has stopped is marked with an arrow [] in the S/W Breakpoints column.

CAUTION

When a break occurs, the program stops immediately before executing the line or instruction at which the software breakpoint is set. If Go or Step is selected after the program has stopped at the breakpoint, the program restarts from the line marked with an arrow.

5.6.2 Adding and Removing Software Breakpoints

Select either of the following ways to add or remove software breakpoints.

- From the Editor or Disassembly window
- From the Breakpoints dialog box (only for removal)
- From the command line

(1) From the Editor or Disassembly window

1. Check that the Editor or Disassembly window that is currently open shows the position at which you want to set a software breakpoint.
2. In the S/W Breakpoints column, double-click on the line where you want the program to stop.

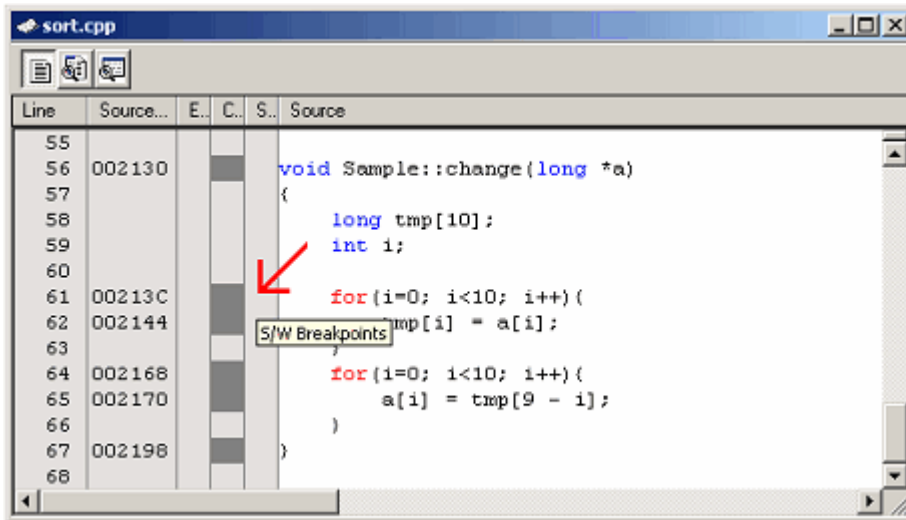

Figure 5.19 Editor window

Alternatively, you can select Toggle Breakpoint from the popup menu or press the F9 key.

3. When a software breakpoint is set, a red circle [●] is displayed at the corresponding position in the S/W Breakpoints column of the Editor or Disassembly window.

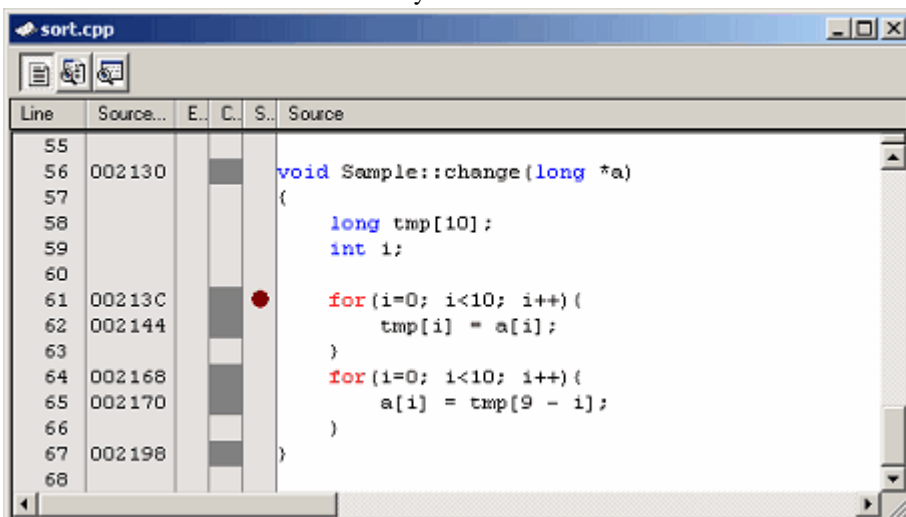

Figure 5.20 Editor window

Double-clicking one more time removes the breakpoint.

5.6.3 Enabling and Disabling Software Breakpoints

Select one of the following ways to enable or disable software breakpoints.

- From the Editor or Disassembly window
- From the Breakpoints dialog box
- From the command line

(1) From the Editor or Disassembly window

1. Place the cursor at the line where a software breakpoint exists and then select Enable/Disable Breakpoint from the popup menu. Alternatively, press the Ctrl and F9 keys at the same time.

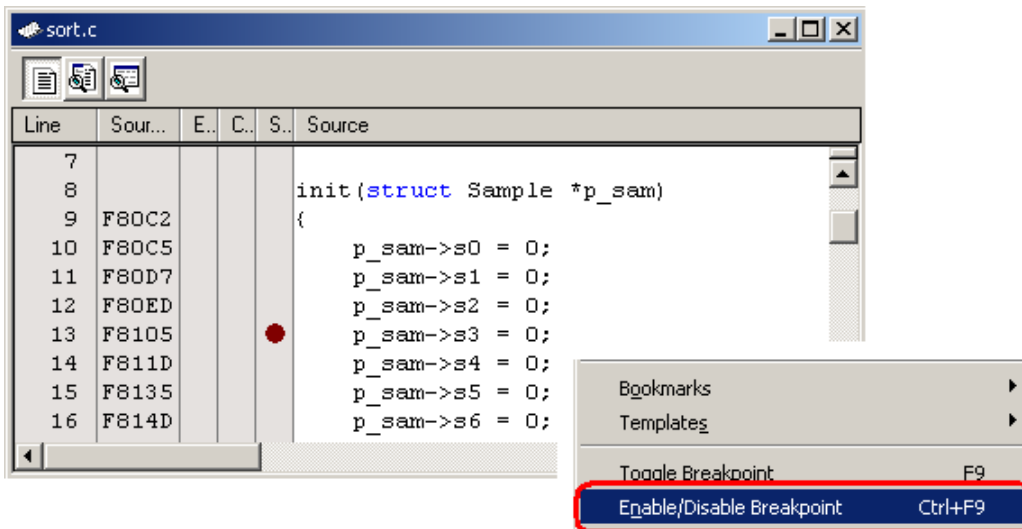

Figure 5.21 Editor window and popup menu

2. The software breakpoint is alternately enabled or disabled.

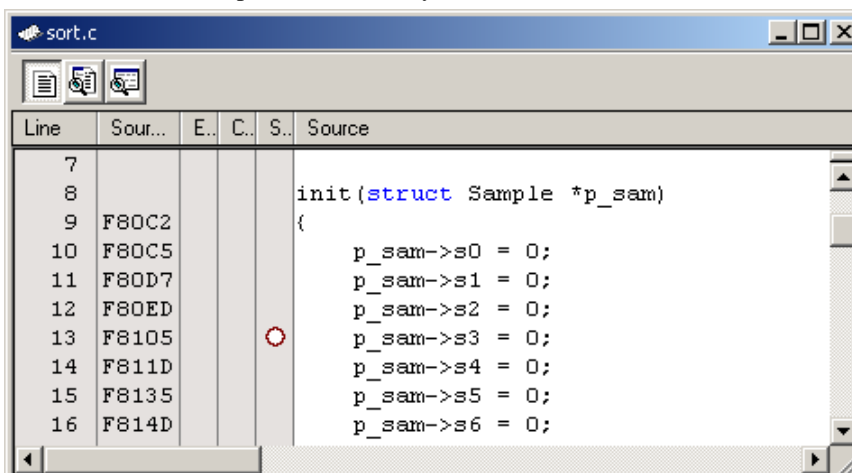

Figure 5.22 Editor window

(2) From the Breakpoints dialog box

1. Select Source Breakpoints from the Edit menu to bring up the Breakpoints dialog box. In this dialog box, you can alternately enable, disable, or remove a currently set breakpoint.

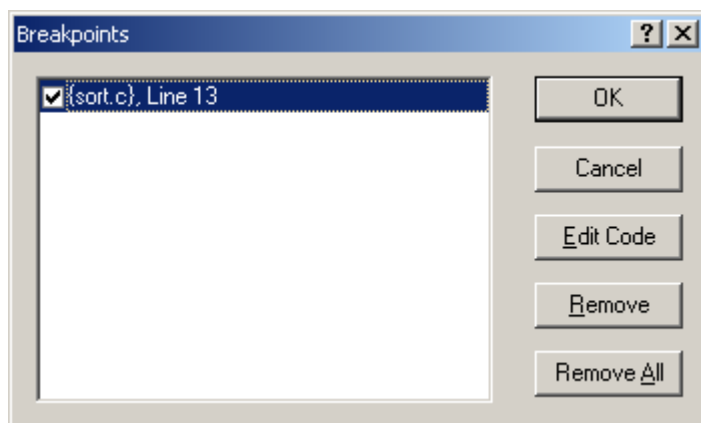

Figure 5.23 Breakpoints dialog box

5.7 Using Events

5.7.1 Using Events

An event refers to a combination of phenomena that occur during program execution.

The E100 emulator permits you to use an event you have set as a condition for the break, trace or performance-analysis function.

Events can be set at up to 16 points at the same time.

These 16 points can be placed as desired.

Events you create can be registered for reuse at a later time.

(1) Types of events

Events are of the following types.

Table 5.9 Event types list

Instruction fetch	The emulator detects that the CPU has executed the instruction at the specified address. Detection is in the cycle of execution by the CPU rather than the cycle of prefetching by the instruction queue.
Data access	The emulator detects access under a specified condition to a specified address or specified address range.
Interrupt	The emulator detects interrupt generation or return from an interrupt handler.
Trigger input	The emulator detects a signal fed in from the input cable for external trigger signals being in a specified state.

(2) Event combinations

The following types of combination can be specified for two or more events.

Table 5.10 Types of event combination

OR	The condition is met when any one of the specified events occurs.
AND (cumulative)	The condition is met when all of the specified events occur regardless of the timing.
AND (simultaneous)	The condition is met when all of the specified events occur at the same time.
Subroutine	The condition is met when a specified event occurs within a specified address range.
Sequential	The condition is met when the specified events occur in a specified order.
State transitions	The condition is met when the events occur in an order specified in the state transition diagram.

5.7.2 Adding Events

Select one of the following ways to add events.

- Create a new event
- Add by dragging and dropping from another window
- Add from the command line

(1) Creating a new event

[Creating an event in the Hardware Break, Trace conditions, or Performance Analysis Conditions dialog box]

1. Click on the Add button or double-click on the line where the new event is to be added.

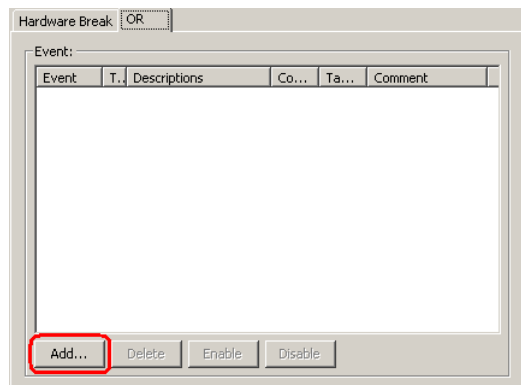

Figure 5.24 Hardware Break dialog box

2. The Event dialog box shown below will be displayed. In this dialog box, set the details of the event condition and then click on the OK button.

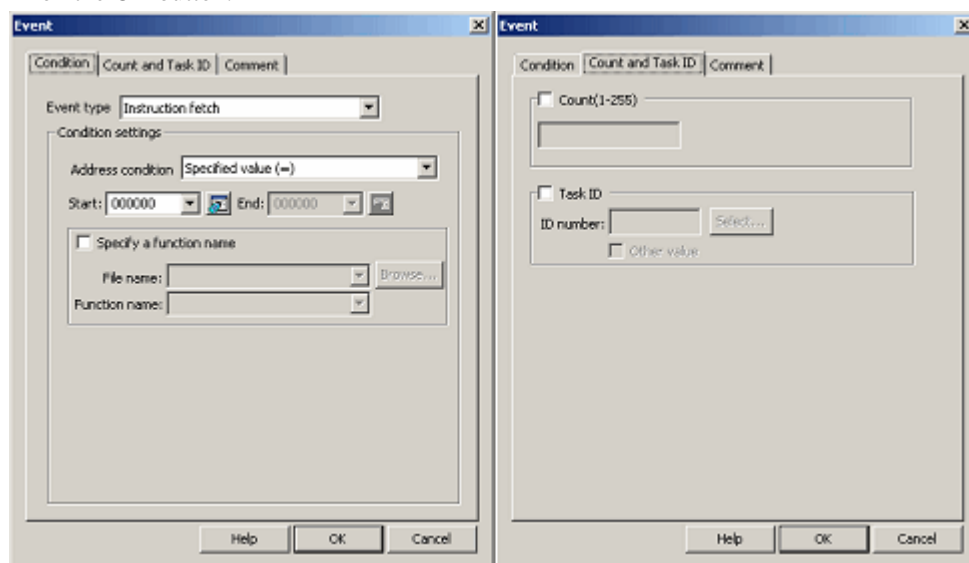

Figure 5.25 Event dialog box

3. An event will be added at the specified position.

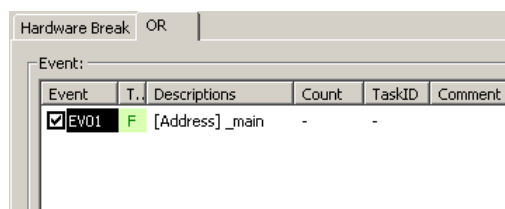

Figure 5.26 Hardware Break dialog box

4. If you create an event that would make the total number of events exceed 16, an error message is displayed. In this case, the event you have added is invalid.

[Adding an event from the Registered Events dialog box]

1. Click on the Add button in the Registered Events dialog box.

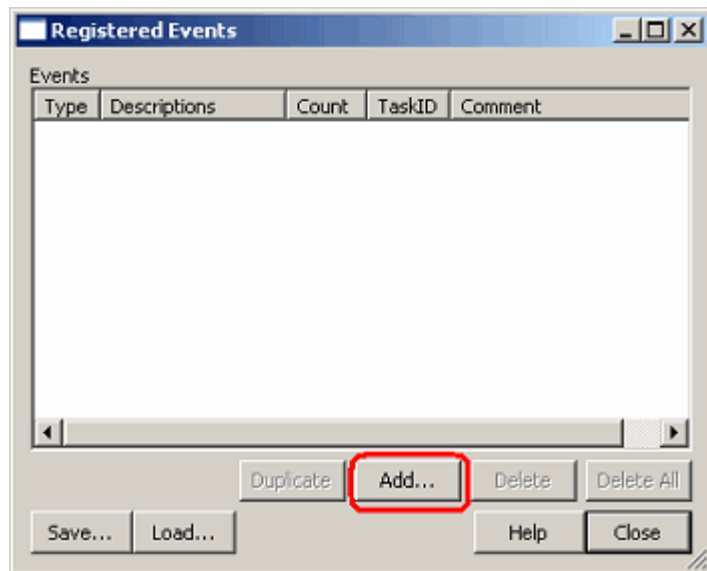

Figure 5.27 Registered Events dialog box

2. The Event dialog box shown below will be displayed. Set details of the event condition in this dialog box. Enter a comment if any is necessary. Then click on the OK button.

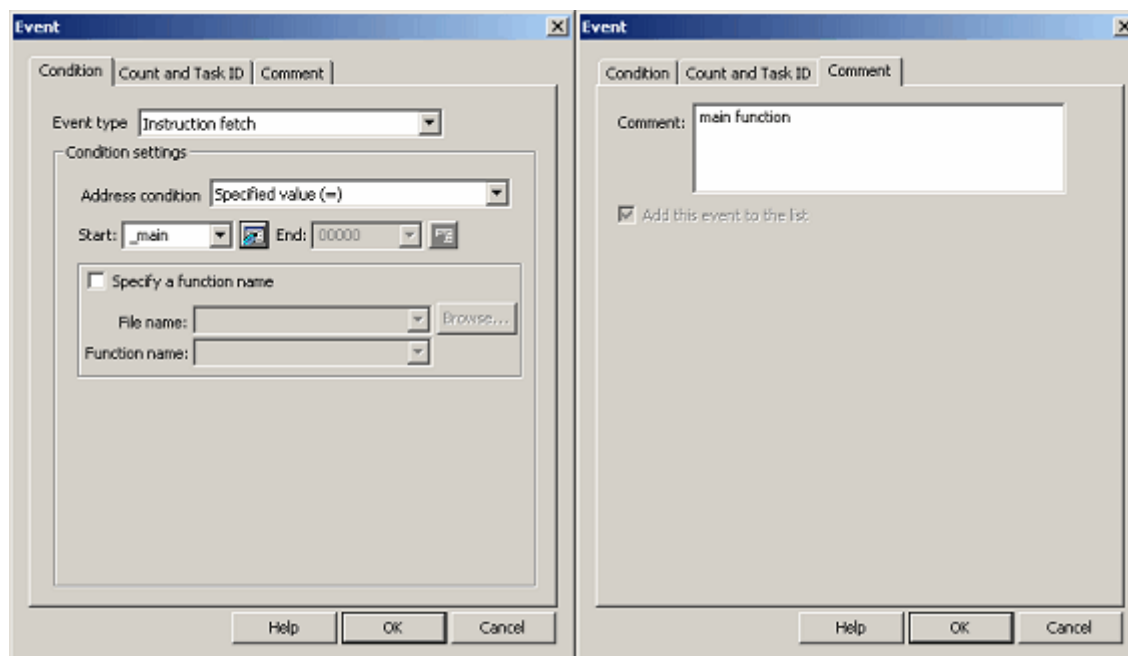

Figure 5.28 Event dialog box

3. The event is added to the list of registered events.

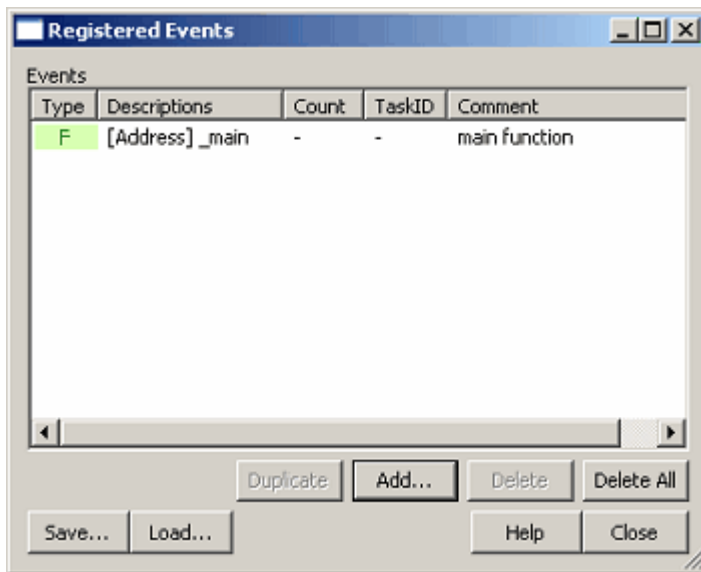

Figure 5.29 Registered Events dialog box

(2) Adding an event from the Event column of the Editor window

[Adding a hardware breakpoint]

1. Select HW Break Point from the popup menu opened by double-clicking or right clicking in the Event column of the Editor window.

This sets fetching from the corresponding address as the condition for a hardware breakpoint, i.e an instruction fetch condition.

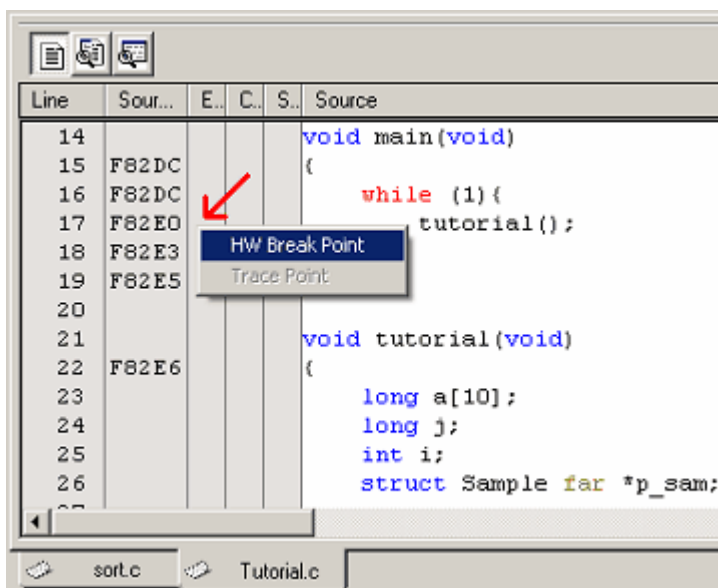

Figure 5.30 Editor window

2. If the number of events currently set allows room for another, the event you have added from the Editor window is added as an OR condition. If there is no room, an error message is displayed.

CAUTION

If you are editing the contents of the Hardware Break dialog box, you cannot set a hardware breakpoint from the Event column of the Editor window.

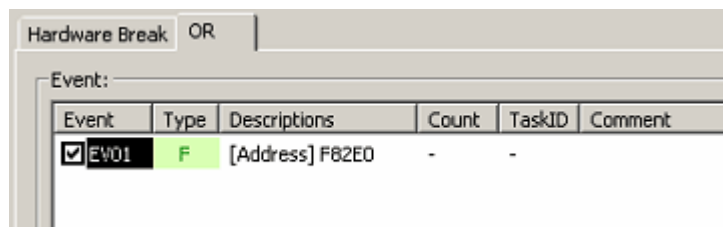

Figure 5.31 Hardware Break dialog box

[Adding a trace point]

1. Double-click or right click in the Event column of the Editor window then select Trace Point from the popup menu.
This sets fetching from the corresponding address as the condition for a trace point, i.e an instruction fetch condition.
Double-click on the instruction fetch event in the Event column of the Editor window to delete it.

CAUTION

Trace points cannot be set in the Event column of the Editor window in the following cases.

- The contents of the Trace conditions dialog box are being edited.
- The selected trace mode is Fill until stop or Fill until full.

(3) Adding events by dragging and dropping

[Dragging and dropping a variable or function name in the Editor window]

1. By dragging and dropping a variable name into the Event column, you can set access to that variable as an event to be detected, i.e. a data-access condition.

At this time, the size of the variable is automatically set as a condition of the data access event.

Only global or static variables taking up 1, 2, or 4 bytes can be registered for event detection. Static variables in functions cannot be registered.

2. By dragging and dropping a function name into the Event column, you can set instruction fetching from the address where that function starts as an event to be detected.

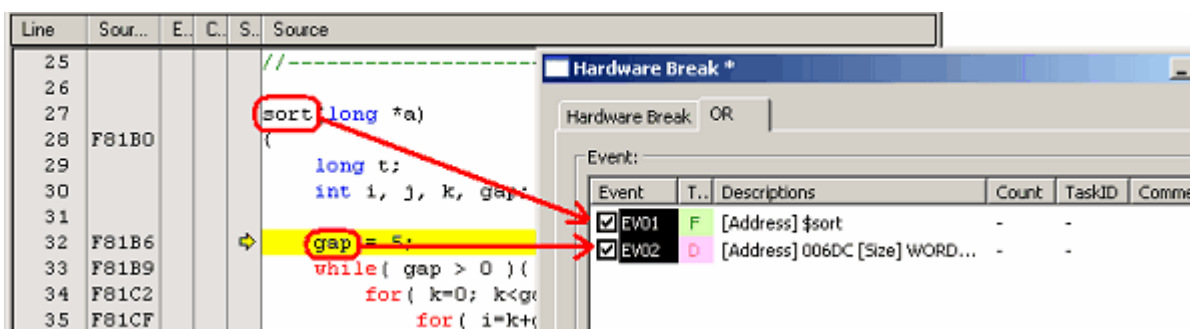

Figure 5.32 Editor window and Hardware Break dialog box

[Dragging and dropping an address range in the Memory window]

Select an address range in the Memory window and drag and drop it into the Event column. In this way, you can set access to an address in the selected address range as a data access event to be detected, i.e. a data access condition.

[Dragging and dropping a label in the Label window]

You can set fetching from the label as an event to be detected, i.e. an instruction fetch condition.

5.7.3 Removing Events

The following ways of removing events are available.

[Deleting an event from the Hardware Break, Trace conditions, or Performance Analysis Conditions dialog box]

1. To remove one point, select the line you want to remove in the Event list and then click on the Delete button (or use the keys Ctrl + Del instead of clicking on the button).

The selected event will be removed from the Event list.

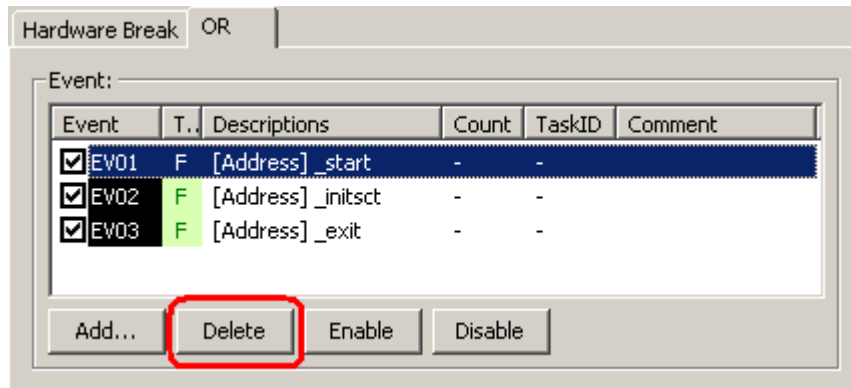

Figure 5.33 Hardware Break dialog box

2. To remove multiple events, hold down the Shift or the Ctrl key while you select lines you want to remove in the Event list and then click on the Delete button (or use the keys Ctrl + Del instead of clicking on the button).

The selected events will be removed from the Event list.

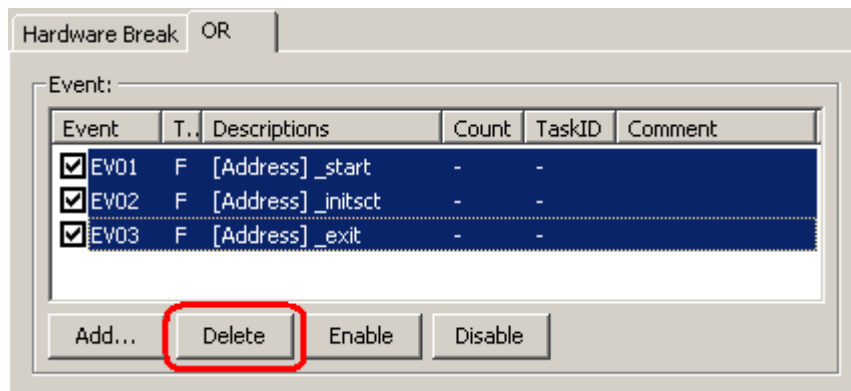

Figure 5.34 Hardware Break dialog box

[Deleting an event from the Registered Events dialog box]

To remove one point, select the line you want to remove in the Registered Events dialog box and then click on the Delete button (or use the keys Ctrl + Del instead of clicking on the button).

The selected event will be removed from the list of registered events.

To delete all events, click on the Delete All button.

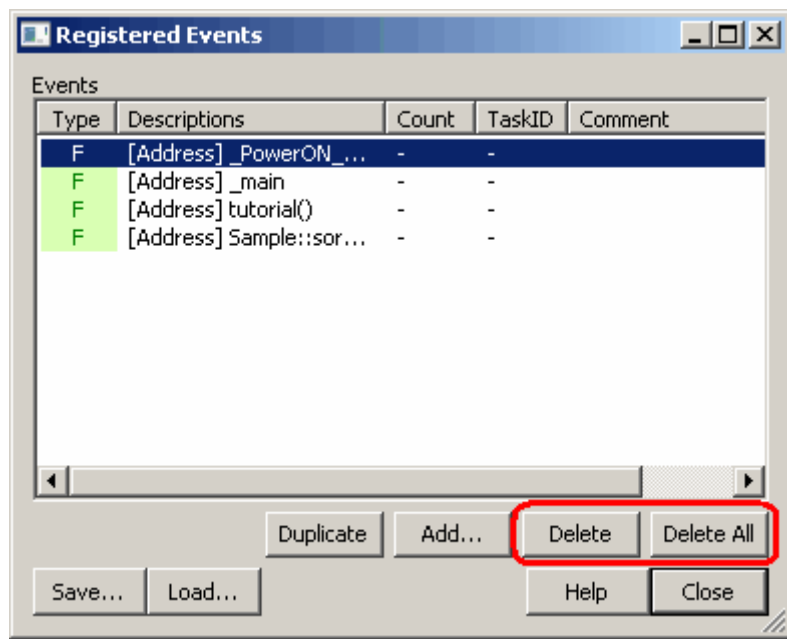

Figure 5.35 Registered Events dialog box

5.7.4 Registering Events

“Registering an event” refers to placing an event in the list of registered events. A registered event can be reused at a later time. Select one of the following ways to register an event. Up to 256 events can be registered.

(1) Registering events

[Creating an event in the Event dialog box]

1. Open the Comment page of the Event dialog box and select the “Add this event to the list” checkbox. Then click on the OK button.

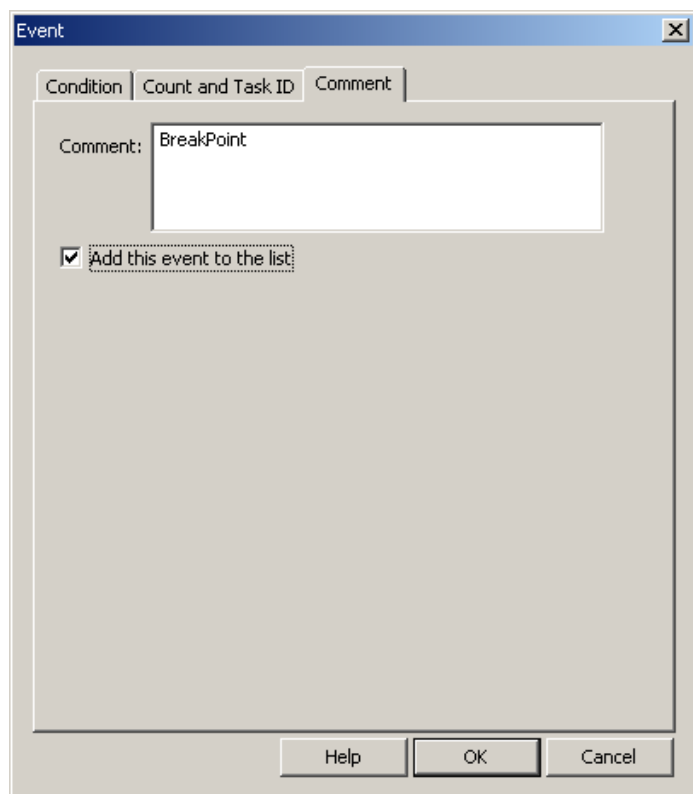

Figure 5.36 Event dialog box

2. The event is added at the specified position and registered in the Registered Events dialog box at the same time.

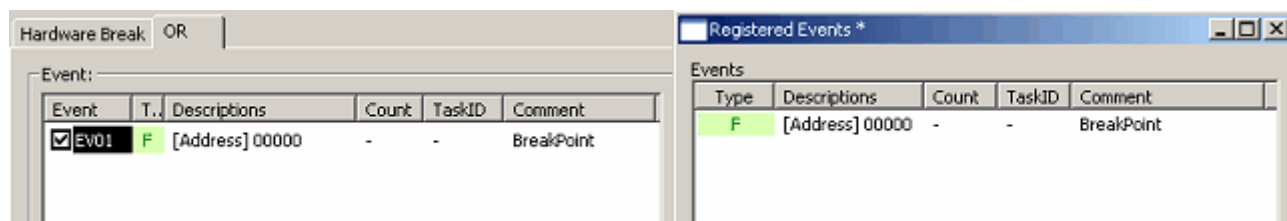

Figure 5.37 Hardware Break dialog box and Registered Events dialog box

[Registering an event by dragging and dropping]

An event you have created can be registered in the Registered Events dialog box by dragging and dropping it into the list.

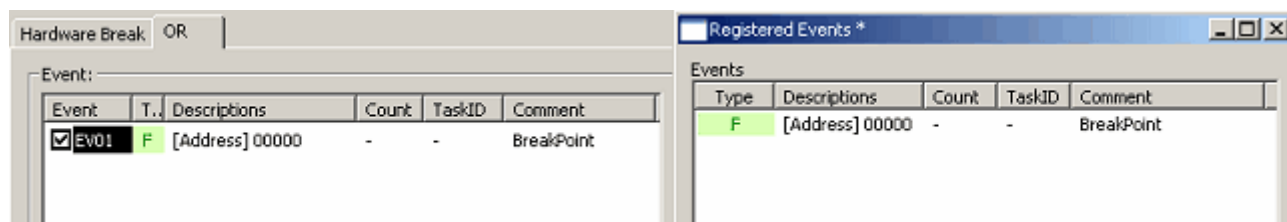

Figure 5.38 Hardware Break dialog box and Registered Events dialog box

[Registering an event in the Registered Events dialog box]

Click on the Add button to create an event. Any event you create here is added to the Registered Events dialog box.

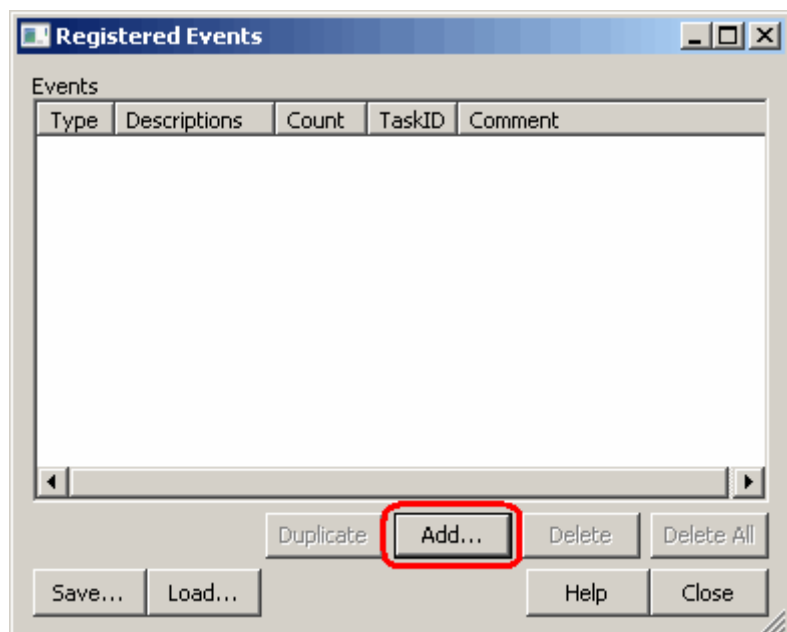

Figure 5.39 Registered Events dialog box

(2) Attaching comments

An explanatory comment for the event can be attached. Check the Registered Events dialog box to see the registered events and comments.

5.7.5 Creating Events for Each Instance of Usage or Reusing Events

The following two approaches are available for setting events in the Hardware Break, Trace conditions, or Performance Analysis Conditions dialog box.

One is to create events in the dialog box each time they are to be used. The other is to choose a condition from the Registered Events dialog box and drag and drop it into the Event list in the Hardware Break, Trace conditions, or Performance Analysis Conditions dialog box.

Here, we refer to the former as creating events per usage and the latter as reusing events.

[Creating events per usage]

Select this method if you intend to use a specific condition only once. The event you have created is used without ever being registered.

Once the event is no longer in use (i.e., it has been changed or deleted), its setting is nonexistent.

Any event created by a simple operation such as double-clicking in the Event column of the Editor window constitutes an event created per usage.

[Reusing events]

Any event registered in the Registered Events dialog box can be reused by dragging and dropping it into the Event list in the Hardware Break, Trace conditions, or Performance Analysis Conditions dialog box.

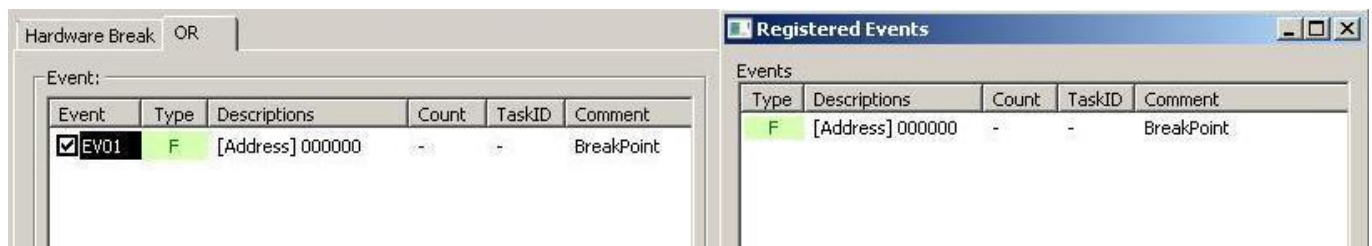

Figure 5.40 Reusing an event

(1) Dragging and dropping an event into multiple dialog boxes

An event in the Registered Events dialog box can be dragged and dropped into multiple dialog boxes.

If a condition of an event is altered after the event has been dragged and dropped, the alteration is not reflected in the setting of the original event in the Registered Events dialog box.

(2) Registering duplicates in the Registered Events dialog box

Even duplicate events that have the same conditions can be registered in the Registered Events dialog box.

5.7.6 Activating Events

To activate the settings for events that you have created, click on the Apply button. Settings you make do not become effective until you click on the Apply button.

[*] after the title on the title bar of the Hardware Break, Trace conditions, or Performance Analysis Conditions dialog box indicates that some setting is being edited. While you are editing an event, you cannot change the settings via the Event column of the Editor window or the command line.

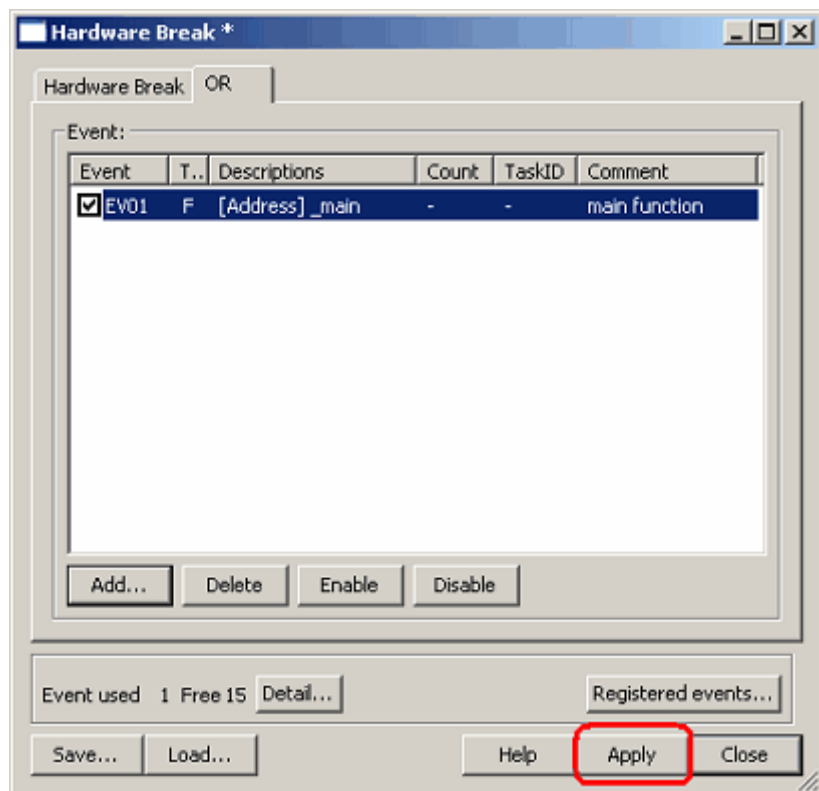

Figure 5.41 Activating the settings

5.8 Setting Hardware Break Conditions

5.8.1 Setting Hardware Break Conditions

A hardware break causes the user program to stop running a specified number of cycles after a specific event or phenomenon is detected (i.e., a hardware breakpoint is encountered). Up to 16 events can be specified as hardware breakpoint conditions.

5.8.2 Setting Hardware Breakpoints

(1) Setting Hardware Breakpoints

For a hardware breakpoint, you can set an OR condition, other conditions (AND (cumulative), AND (simultaneous), subroutine, sequential or state transitions) and detection of exceptional events.

For each hardware breakpoint, you can specify all or only one from among the OR condition, other conditions, and detection of exceptional events.

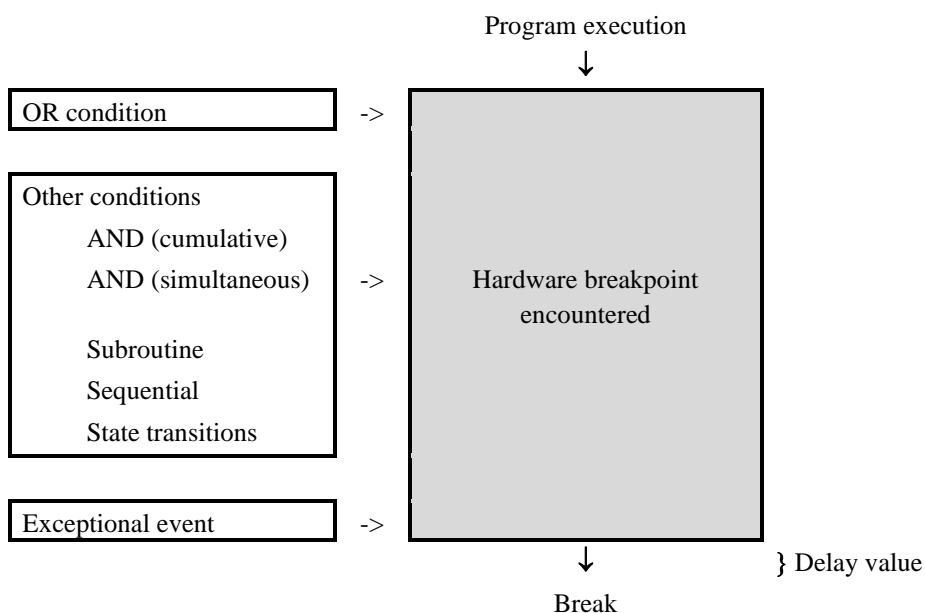

Figure 5.42 A hardware break in outline

(2) Setting an OR condition

You can choose to enable or disable the OR condition. By default, the OR condition is enabled.

To disable the OR condition, deselect the checkbox to the left of "OR condition."

If you add an event by double-clicking in the Editor window while the OR condition is disabled, the OR condition is automatically enabled.

When the OR condition is re-enabled, the previous event settings on the OR page (with their checkboxes being selected) are restored.

However, if re-enabling the OR condition would bring the total number of events to more than 16, the events are restored with their checkboxes not selected (disabled) on the OR page.

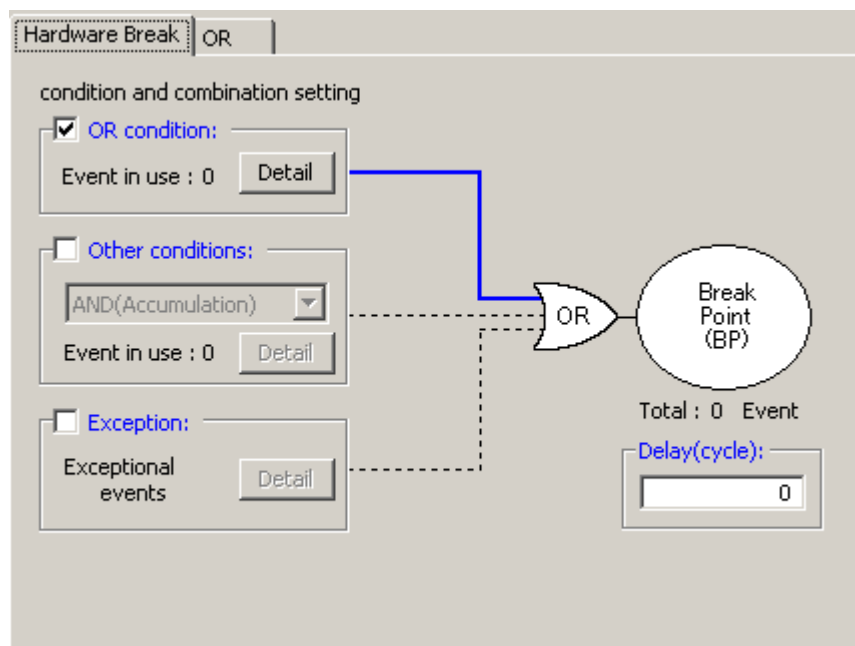

Figure 5.43 Hardware Break dialog box

Table 5.11 OR condition

Type	Description
OR condition	A breakpoint is encountered when any of the specified events occurs.

(3) Setting other conditions

You can select one from among five available choices: AND (cumulative), AND (simultaneous), Subroutine, Sequential and State transitions. To set any condition, select the checkbox to the left of “Other conditions.” Other conditions are disabled by default (the checkbox to the left of “Other conditions” is not selected). Cumulative AND is listed as “AND(Accumulation)” in the dialog box.

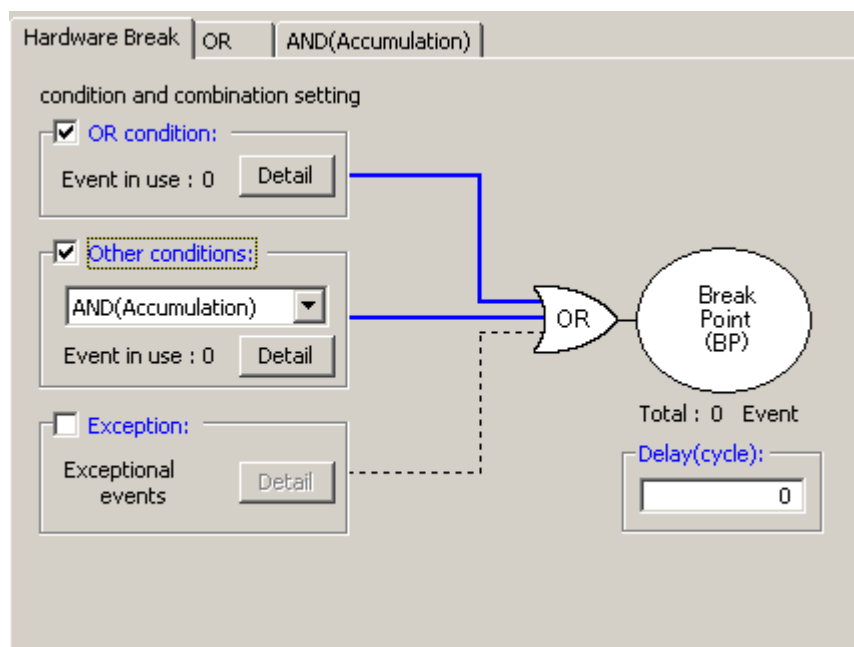

Figure 5.44 Hardware Break dialog box

Table 5.12 Other conditions

Type	Description
AND (cumulative)	A breakpoint is encountered when all of the specified events have occurred regardless of their timing and order.
AND (simultaneous)	A breakpoint is encountered when all of the specified events occur at the same time.
Subroutine	A breakpoint is encountered when a specified event occurs within a specified address range (subroutine or function).
Sequential	6 steps (forward direction) + reset point A breakpoint is encountered when the specified events occur in a specified order.
State transitions	3 steps, 9 paths + reset point A breakpoint is encountered when the specified events occur in a specified order.

The events shown in the list for each condition can be deleted by the keys Ctrl + Del.

CAUTION

When a time-out condition is set in State transitions (Hardware break point) dialog box, the time to make transition from a set state to another then back to the original set state must be 10 μ s or more. Transition time of less than 10 μ s will result in an incorrect timeout detection.

(4) Detection of exceptional events

Specify whether you want detection of the following exceptional events to be used as a breakpoint.

- Violation of access protection
- Reading from a non-initialized memory area
- Stack access violation
- Performance-measurement overflow
- Realtime profile overflow
- Trace memory overflow
- Task stack access violation
- OS dispatch

(5) Specifying a delay value

If this checkbox is selected, program execution breaks the specified number of bus cycles after the breakpoint is encountered. The delay value is specifiable in the range from 0 to 65,535 (default = 0).

5.8.3 Saving/Loading Hardware Break Settings

(1) Saving hardware break settings

Click on the Save button of the Hardware Break dialog box. The Save dialog box will be displayed.

Specify the name of the file where you want the break settings to be saved. The file-name extension is “.hev”. If this is omitted, the extension “.hev” is automatically appended.

(2) Loading hardware break settings

Click on the Load button of the Hardware Break dialog box. The Load dialog box will be displayed. Specify the name of the file you want to load.

When you load a file, the previous hardware break settings are discarded and the new settings appear in the dialog box.

Click on the Apply button of the Hardware Break dialog box to activate the new hardware break settings you have loaded.

5.9 Viewing Trace Information

5.9.1 Viewing Trace Information

Tracing means the acquisition of bus information per cycle and storage of this information in trace memory during user program execution. You can use tracing to track the flow of application execution or to search for and examine the points where problems arise.

The E100 emulator allows acquisition of up to 4-M bus cycles.

When program execution stops (due to an exception break, forced stop or breakpoint), the contents of trace memory at the time the program has stopped are displayed as the result of tracing, even if no trace points have been encountered yet.

5.9.2 Acquiring Trace Information

In cases where no trace acquisition conditions are set, the default behavior of the E100 emulator is to acquire information on all bus cycles unconditionally (trace mode = Fill until stop).

In “fill until stop” mode, the emulator starts trace acquisition as soon as the user program starts running. When the user program stops, the emulator stops tracing.

The acquired trace information is displayed in the Trace window.

Cycle	Label	Address	Data	Size	R/W	BMT	Status	Area	IMD0	IMD2	BUSACC	DEBUG	EDDMARD	EXCMARR	RFSHON	IRQ	EV	TimeStamp (h:m:s.ms.us.ns)
-00000017	FFBFA2	DE29	LONG WORD	R	0	DATA	RAM	-	-	1	1	1	1	1	1	1	0000000000000000	00:00:00.000.477.470
-00000016	FFBFA4	000A	LONG WORD	R	0	DATA	RAM	-	-	1	1	1	1	1	1	1	0000000000000000	00:00:00.000.477.500
-00000015	FFBFA6	00FF	LONG WORD	R	0	DATA	RAM	-	-	1	1	1	1	1	1	1	0000000000000000	00:00:00.000.477.530
-00000014	FFBFA8	BFDA	LONG WORD	R	0	DATA	RAM	-	-	1	1	1	1	1	1	1	0000000000000000	00:00:00.000.477.560
-00000013	0021D8	6D73	WORD	R	0	FETCH	ROM	-	-	1	1	1	1	1	1	1	0000000000000000	00:00:00.000.477.590
-00000012	0021DA	5470	WORD	R	0	FETCH	ROM	-	-	1	1	1	1	1	1	1	0000000000000000	00:00:00.000.477.620
-00000011	000000	00--	BYTE	-	0	NONE	NONE	-	-	1	1	1	1	1	1	1	0000000000000000	00:00:00.000.477.650
-00000010	FFBFAA	0000	LONG WORD	R	0	DATA	RAM	-	-	1	1	1	1	1	1	1	0000000000000000	00:00:00.000.477.680
-00000009	FFBFAC	20DA	LONG WORD	R	0	DATA	RAM	-	-	1	1	1	1	1	1	1	0000000000000000	00:00:00.000.477.710
-00000008	FFBFAC	00FF	LONG WORD	R	0	DATA	RAM	-	-	1	1	1	1	1	1	1	0000000000000000	00:00:00.000.477.740
-00000007	FFBF00	A3E0	LONG WORD	R	0	DATA	RAM	-	-	1	1	1	1	1	1	1	0000000000000000	00:00:00.000.477.770
-00000006	0021DC	D482	WORD	R	0	FETCH	ROM	-	-	1	1	1	1	1	1	1	0000000000000000	00:00:00.000.477.800
-00000005	FFBF02	0000	WORD	R	0	DATA	RAM	-	-	1	1	1	1	1	1	1	0000000000000000	00:00:00.000.477.830
-00000004	FFBF04	106C	WORD	R	0	DATA	RAM	-	-	1	1	1	1	1	1	1	0000000000000000	00:00:00.000.477.860
-00000003	000000	00--	BYTE	-	0	NONE	NONE	-	-	1	1	1	1	1	1	1	0000000000000000	00:00:00.000.477.890
-00000002	00106C	5770	WORD	R	0	FETCH	ROM	-	-	1	1	1	1	1	1	1	0000000000000000	00:00:00.000.477.920
-00000001	00106E	6970	WORD	R	0	FETCH	ROM	-	-	1	1	1	1	1	1	1	0000000000000000	00:00:00.000.477.950
00000000	001070	00--	BYTE	-	1	NONE	NONE	-	-	1	1	1	1	1	1	1	0000000000000000	00:00:00.000.477.980

Figure 5.45 Trace window

The following items are shown in the Trace window (in bus display mode).

Table 5.13 Items shown in the Trace window

Column	Description																								
Cycle	Number of the cycle within trace memory. By default, the number of the last cycle to have been acquired is 0, and earlier cycles are assigned progressively lower numbers in sequence, i.e. -1, -2, etc. If a delay count is set, the cycle on which the trace stop condition is met is numbered 0 and the cycles that were executed until the program actually stopped (cycles during a delay period) are assigned progressively larger numbers +1, +2, etc. in sequence up to the last cycle to be acquired.																								
Label	Label corresponding to the address (displayed only when a label has been set)																								
Address	Address on the address bus																								
Data	Data on the data bus (in hexadecimal)																								
Size	Unit of access (byte, word, or longword)																								
R/W	Data bus state, indicated as "R" for reading, "W" for writing, or "-" for no access																								
RWT	Whether the bus cycle is valid or not. The value "0" indicates a valid bus cycle. The Address, Data and BIU information is valid when RWT is "0".																								
Status	<p>Operating state of the target MCU.</p> <table border="1"> <thead> <tr> <th>Display form</th> <th>Description</th> </tr> </thead> <tbody> <tr> <td>DMAC</td> <td>Access by DMAC operation</td> </tr> <tr> <td>DTC</td> <td>Access by DTC operation</td> </tr> <tr> <td>HUDI</td> <td>Access by HUDI operation</td> </tr> <tr> <td>DATA</td> <td>Data access by CPU operation</td> </tr> <tr> <td>FETCH</td> <td>Instruction fetch by CPU operation</td> </tr> <tr> <td>SLEEP DMAC</td> <td>Sleeping due to DMAC operation</td> </tr> <tr> <td>SLEEP DTC</td> <td>Sleeping due to DTC operation</td> </tr> <tr> <td>SLEEP HUDI</td> <td>Sleeping due to HUDI operation</td> </tr> <tr> <td>SLEEP</td> <td>CPU is in the sleep mode</td> </tr> <tr> <td>AMCS</td> <td>Supply of clock signal to all modules is stopped.</td> </tr> <tr> <td>NONE</td> <td>No access</td> </tr> </tbody> </table>	Display form	Description	DMAC	Access by DMAC operation	DTC	Access by DTC operation	HUDI	Access by HUDI operation	DATA	Data access by CPU operation	FETCH	Instruction fetch by CPU operation	SLEEP DMAC	Sleeping due to DMAC operation	SLEEP DTC	Sleeping due to DTC operation	SLEEP HUDI	Sleeping due to HUDI operation	SLEEP	CPU is in the sleep mode	AMCS	Supply of clock signal to all modules is stopped.	NONE	No access
Display form	Description																								
DMAC	Access by DMAC operation																								
DTC	Access by DTC operation																								
HUDI	Access by HUDI operation																								
DATA	Data access by CPU operation																								
FETCH	Instruction fetch by CPU operation																								
SLEEP DMAC	Sleeping due to DMAC operation																								
SLEEP DTC	Sleeping due to DTC operation																								
SLEEP HUDI	Sleeping due to HUDI operation																								
SLEEP	CPU is in the sleep mode																								
AMCS	Supply of clock signal to all modules is stopped.																								
NONE	No access																								
Area	<p>Area being accessed.</p> <table border="1"> <thead> <tr> <th>Display form</th> <th>Description</th> </tr> </thead> <tbody> <tr> <td>EXT16</td> <td>16-bit external space</td> </tr> <tr> <td>EXT8</td> <td>8-bit external space</td> </tr> <tr> <td>EXTMEM16</td> <td>16-bit external emulation memory</td> </tr> <tr> <td>EXTMEM8</td> <td>8-bit external emulation memory</td> </tr> <tr> <td>ROM</td> <td>Internal ROM</td> </tr> <tr> <td>DATAFLASH</td> <td>Data flash</td> </tr> <tr> <td>I/O16</td> <td>Internal I/O space (16-bit I/O)</td> </tr> <tr> <td>I/O8</td> <td>Internal I/O space (8-bit I/O)</td> </tr> <tr> <td>RAM</td> <td>Internal RAM</td> </tr> <tr> <td>DTCRAM32</td> <td>Internal RAM (32 bits) accessed due to DTC operation</td> </tr> <tr> <td>NONE</td> <td>No access</td> </tr> </tbody> </table>	Display form	Description	EXT16	16-bit external space	EXT8	8-bit external space	EXTMEM16	16-bit external emulation memory	EXTMEM8	8-bit external emulation memory	ROM	Internal ROM	DATAFLASH	Data flash	I/O16	Internal I/O space (16-bit I/O)	I/O8	Internal I/O space (8-bit I/O)	RAM	Internal RAM	DTCRAM32	Internal RAM (32 bits) accessed due to DTC operation	NONE	No access
Display form	Description																								
EXT16	16-bit external space																								
EXT8	8-bit external space																								
EXTMEM16	16-bit external emulation memory																								
EXTMEM8	8-bit external emulation memory																								
ROM	Internal ROM																								
DATAFLASH	Data flash																								
I/O16	Internal I/O space (16-bit I/O)																								
I/O8	Internal I/O space (8-bit I/O)																								
RAM	Internal RAM																								
DTCRAM32	Internal RAM (32 bits) accessed due to DTC operation																								
NONE	No access																								
IMD0	<p>States of interrupt mask bits of the condition code register in interrupt control mode 0.</p> <table border="1"> <thead> <tr> <th>Display form</th> <th>Description</th> </tr> </thead> <tbody> <tr> <td></td> <td>Bit CCR I</td> </tr> <tr> <td>.</td> <td>0</td> </tr> <tr> <td>I</td> <td>1</td> </tr> <tr> <td>-</td> <td>The entry under IMD0 is "-" if IMD2 values are being displayed.</td> </tr> </tbody> </table>	Display form	Description		Bit CCR I	.	0	I	1	-	The entry under IMD0 is "-" if IMD2 values are being displayed.														
Display form	Description																								
	Bit CCR I																								
.	0																								
I	1																								
-	The entry under IMD0 is "-" if IMD2 values are being displayed.																								

Column	Description																																												
IMD2	<u>Interrupt mask levels of the extend register in interrupt control mode 2.</u>																																												
	<table border="1"> <thead> <tr> <th>Display form</th> <th colspan="3">Description</th> </tr> <tr> <th></th> <th>Bit EXR I2</th> <th>Bit EXR I1</th> <th>Bit EXR I0</th> </tr> </thead> <tbody> <tr> <td>0</td> <td>0</td> <td>0</td> <td>0</td> </tr> <tr> <td>1</td> <td>0</td> <td>0</td> <td>1</td> </tr> <tr> <td>2</td> <td>0</td> <td>1</td> <td>0</td> </tr> <tr> <td>3</td> <td>0</td> <td>1</td> <td>1</td> </tr> <tr> <td>4</td> <td>1</td> <td>0</td> <td>0</td> </tr> <tr> <td>5</td> <td>1</td> <td>0</td> <td>1</td> </tr> <tr> <td>6</td> <td>1</td> <td>1</td> <td>0</td> </tr> <tr> <td>7</td> <td>1</td> <td>1</td> <td>1</td> </tr> <tr> <td>-</td> <td colspan="3">The entry under IMD2 is "-" if IMD0 values are being displayed.</td> </tr> </tbody> </table>	Display form	Description				Bit EXR I2	Bit EXR I1	Bit EXR I0	0	0	0	0	1	0	0	1	2	0	1	0	3	0	1	1	4	1	0	0	5	1	0	1	6	1	1	0	7	1	1	1	-	The entry under IMD2 is "-" if IMD0 values are being displayed.		
	Display form	Description																																											
		Bit EXR I2	Bit EXR I1	Bit EXR I0																																									
	0	0	0	0																																									
	1	0	0	1																																									
	2	0	1	0																																									
	3	0	1	1																																									
	4	1	0	0																																									
	5	1	0	1																																									
6	1	1	0																																										
7	1	1	1																																										
-	The entry under IMD2 is "-" if IMD0 values are being displayed.																																												
BUSACC	0 indicates that the emulator has taken over the MCU bus while the user program was running. The emulator takes over the MCU bus when access to memory is attempted by a debugger operation. Note: Execution of the user program is temporarily stopped during such access to memory.																																												
DEBUG	0 indicates that the emulator has taken over the MCU bus while the user program was running. The emulator takes over the MCU bus when access to memory is attempted by a debugger operation. Note: Execution of the user program is temporarily stopped during such access to memory.																																												
EXDMARD	Whether EXDMAC reading occurred during the cycle. 0: EXDMAC reading occurred. 1: EXDMAC reading did not occur.																																												
EXDMAWR	Whether EXDMAC writing occurred during the cycle. 0: EXDMAC writing occurred. 1: EXDMAC writing did not occur.																																												
RFSHON	Whether refreshing occurred during the cycle. 0: Refreshing occurred. 1: Refreshing did not occur.																																												
IRQ	Whether a user IRQ signal that is being monitored was output during the cycle. 0: An IRQ signal was output. 1: No IRQ signal was output.																																												
EV	If an event occurred, the number of the event. To show the EV column, you need to select Event number on the Option page of the Trace conditions dialog box opened by choosing Acquisition from the popup menu of the Trace window.																																												
TID	Task ID (when the RTOS is in use) Task IDs are shown in the form "task ID (task entry label)", such as 1 (_Task1). To show the Task ID column, you need to select Task ID on the Option page of the Trace conditions dialog box opened by choosing Acquisition from the popup menu of the Trace window.																																												
EXT	Signal fed in from the external trigger cable; "1" and "0" indicate the signal being at the high and low levels, respectively. To show the EXT column, you need to select External trigger on the Option page of the Trace conditions dialog box opened by choosing Acquisition from the popup menu of the Trace window.																																												
TimeStamp	Time elapsed since the target program has started. Each time the user program starts running, timestamping starts from 0. Note: After the counter has overflowed, the times displayed will not be correct. The maximum timestamp value is 3 hours 03 minutes 15 seconds.																																												

Columns of the Trace window can be hidden if you do not require them. To hide a column, right-click in the header column and select the column you want to hide from the popup menu.

5.9.3 Setting Conditions for Trace Information Acquisition

Since the size of the trace buffer is limited, the oldest trace data is overwritten with new data after the buffer has become full. You can set trace conditions to restrict the acquired trace information to that which is useful, thus more effectively using the trace buffer.

To set trace conditions, use the Trace conditions dialog box that is displayed when you choose Acquisition from the popup menu of the Trace window.

(1) Selecting the trace mode

Start by selecting the trace mode.

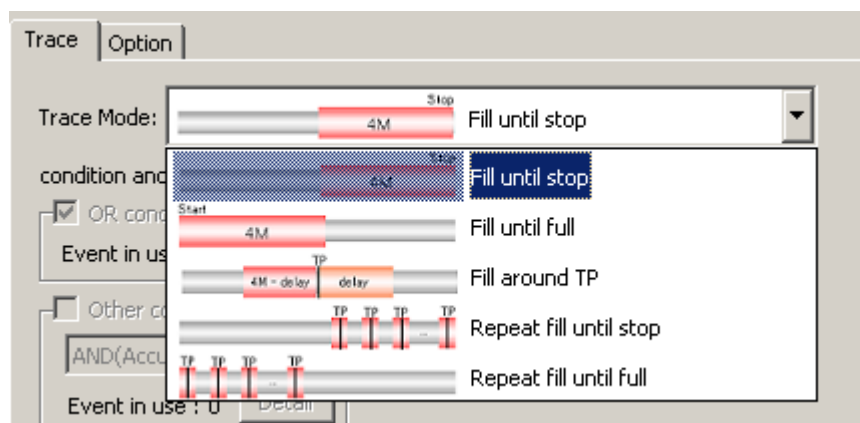

Figure 5.46 Trace conditions dialog box

(2) Setting trace points

If you have selected Fill around TP, Repeat fill until stop or Repeat fill until full, you need to set a trace point.

For trace points, you can specify conditions using events and/or the detection of specific exceptional events.

For Fill around TP, you can also specify a delay value.

(3) Selecting Capture or Do not capture

If the selected trace mode is Fill until stop, Fill until full or Fill around TP, you can specify Capture or Do not capture in the Record condition group box.

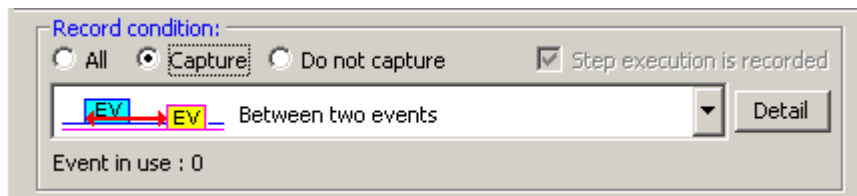

Figure 5.47 Record condition group box

You can specify events so as to extract only the required portions or to eliminate non-required portions of the trace information.

(4) Recording step execution

If the selected trace mode is Fill until stop, you can record step execution. To record step execution, select the Step execution is recorded checkbox in the Record condition group box.

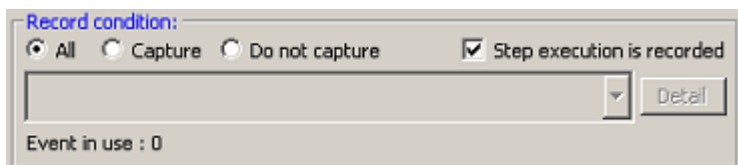

Figure 5.48 Recording step execution

The recordable modes of step execution are Step In, Step Over and Step Out.

(5) Selecting the type of trace information to be acquired

Use the Option page of the Trace conditions dialog box to select the type of trace information to be stored in the trace memory. By default, 'Event number' is selected as the type of trace information.

5.9.4 Selecting the Trace Mode

(1) Selecting the trace mode

The following five trace modes are available.

Table 5.14 Trace modes

Trace mode	Description
Fill until stop	Trace acquisition continues until the program stops running.
Fill until full	Trace acquisition stops when the trace memory becomes full.
Fill around TP	Trace acquisition stops a specified number of cycles after a trace point is encountered. A delay value can be specified in the range up to the maximum value of trace capacity.
Repeat fill until stop	For each trace point encountered in program execution, information for a total of 512 cycles* before and after the point is acquired, and acquisition continues in the same way until the program stops running.
Repeat fill until full	For each trace point encountered in program execution, information for a total of 512 cycles* before and after the point is acquired, and acquisition continues in the same way until the trace memory is full.

CAUTION

*Recording is for 512-cycles units, consisting of the lines for the cycle at the trace point, for the 255 cycles before that point, and for the 256 cycles after that point.

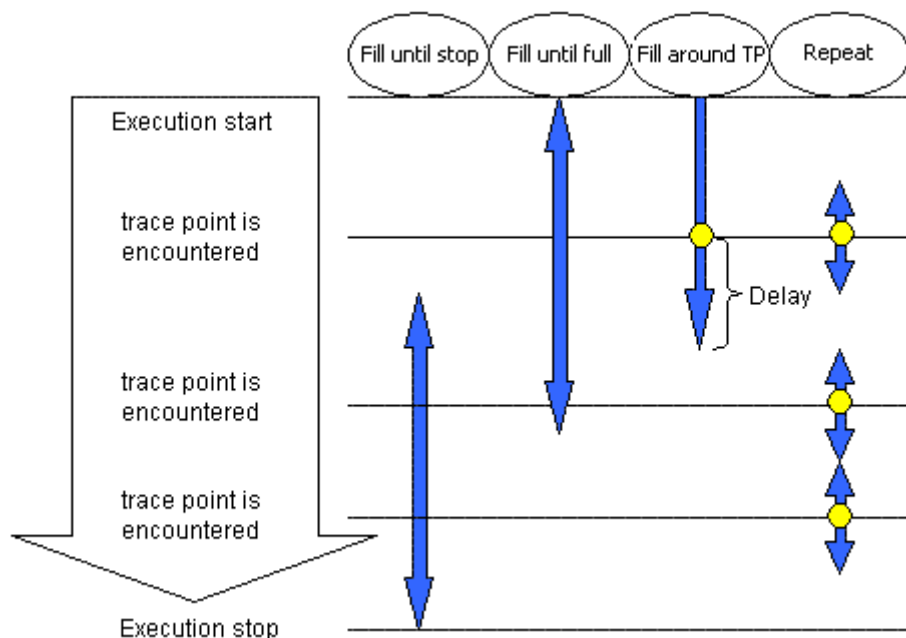

Figure 5.49 Differences between the trace modes

Specifiable conditions vary with the trace mode, as summarized in the tables below.

1. Fill until stop

The trace memory can hold up to 4-M bus cycles. When the buffer becomes full, the oldest data among the acquired trace information are overwritten with new data. The emulator continues acquiring trace information in this way until the program is stopped.

Table 5.15 Specifiable conditions: Fill until stop

Trace point	Delay	Specifying capture/do not capture	Recording of step execution
-	-	Possible	Possible

2. Fill until full

Once the trace memory of the emulator overflows during trace acquisition, the emulator stops acquiring trace information.

Table 5.16 Specifiable conditions: Fill until full

Trace point	Delay	Specifying capture/do not capture	Recording of step execution
-	-	Possible	-

3. Fill around TP

Trace acquisition is halted a specified number of cycles after a trace point is encountered. In this mode, the user program continues running and only trace acquisition is halted. Sophisticated conditions can be set using a maximum of 16 event points. The delay value can be chosen as 0-M, 1-M, 2-M, 3-M or 4-M cycles.

Table 5.17 Specifiable conditions: Fill around TP

Trace point	Delay	Specifying capture/do not capture	Recording of step execution
Possible	Possible	Possible	-

4. Repeat fill until stop

For each time trace point encountered, information for a total of 512 cycles before and after that point is acquired, and acquisition continues in the same way until the program stops running. Acquisition continues until it is halted by a break or forced stop. The positions where trace points have been encountered can be checked in the Trace window.

Table 5.18 Specifiable conditions: Repeat fill until stop

Trace point	Delay	Specifying capture/do not capture	Recording of step execution
Possible	-	-	-

5. Repeat fill until full

For each time trace point encountered, information for a total of 512 cycles before and after that point is acquired. Acquisition continues in the same way until the trace memory overflows, at which time acquisition is halted. The positions where trace points have been encountered can be checked in the Trace window.

Table 5.19 Specifiable conditions: Repeat fill until full

Trace point	Delay	Specifying capture/do not capture	Recording of step execution
Possible	-	-	-

CAUTION

If trace points are encountered in consecutive cycles in the repeat fill until stop or repeat fill until full mode, the yellow highlight that indicates a trace point only appears for the trace point in the first of the cycles.

5.9.5 Setting Trace Points

(1) Setting trace points

For trace points, you can set an OR condition, other conditions (AND (cumulative), AND (simultaneous), subroutine, sequential or state transitions) and detection of exceptional events.

You can specify all or only one of the OR condition, other conditions and detection of exceptional events at a time.

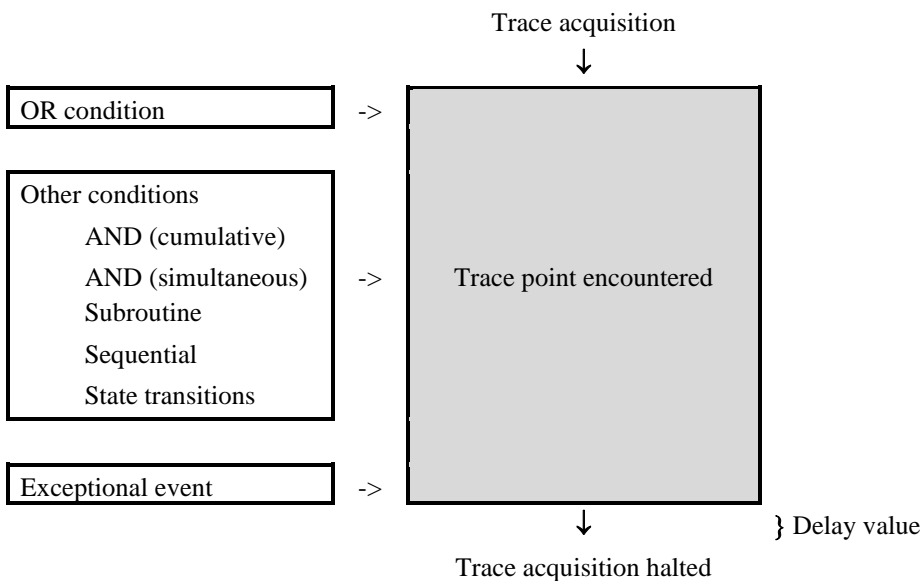

Figure 5.50 A trace point in outline

(2) OR condition

You can choose to enable or disable the OR condition. By default, the OR condition is enabled.

When the OR condition is re-enabled, the previous event settings on the OR page (with their checkboxes being selected) are restored.

However, if re-enabling the OR condition would bring the total number of events to more than 16, the events are restored with their checkboxes not selected (disabled) on the OR page.

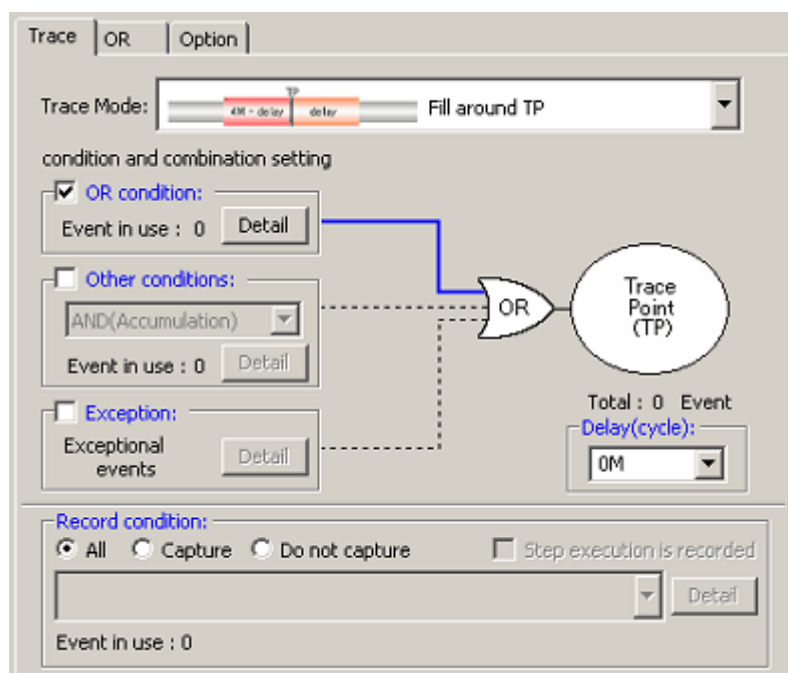

Figure 5.51 Trace conditions dialog box

Table 5.20 OR condition

Type	Description
OR condition	A trace point is encountered when any of the specified events occurs.

(3) Other conditions

You can select one from among five available choices: AND (cumulative), AND (simultaneous), Subroutine, Sequential and State transitions. To set any condition, select the checkbox to the left of “Other conditions.”

Other conditions are disabled by default (the checkbox to the left of “Other conditions” is not selected). Cumulative AND is listed as “AND(Accumulation)” in the dialog box.

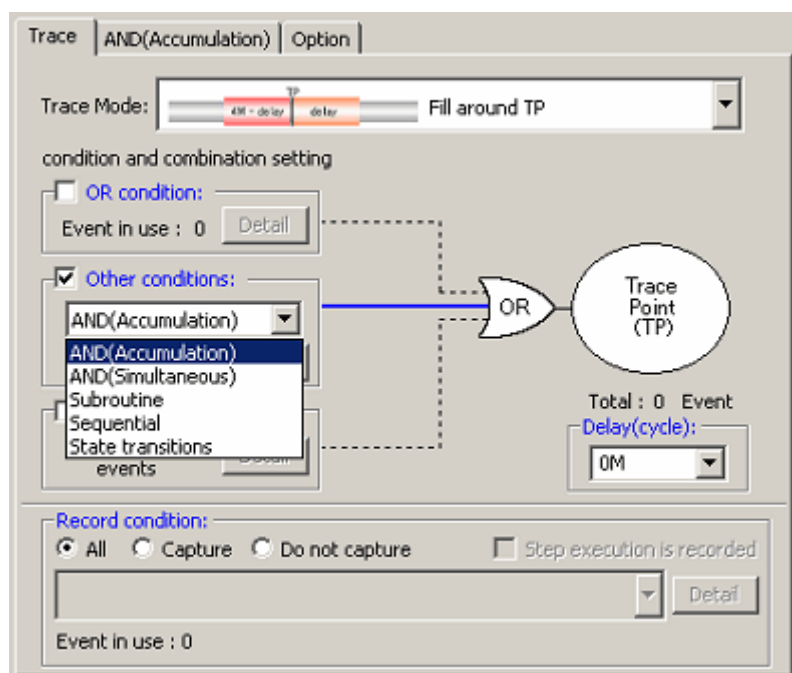

Figure 5.52 Trace conditions dialog box

Table 5.21 Other conditions

Type	Description
AND (cumulative)	A trace point is encountered when all of the specified events have occurred, regardless of the timing.
AND (simultaneous)	A trace point is encountered when all of the specified events occur at the same time.
Subroutine	A trace point is encountered when a specified event occurs within a specified address range (subroutine or function).
Sequential	6 steps (forward direction) + reset point A trace point is encountered when the specified events occur in a specified order.
State transitions	3 steps, 9 paths + reset point A trace point is encountered when the specified events occur in a specified order.

CAUTION

When a time-out condition is set in State transitions (Trace) dialog box, the time to make transition from a set state to another then back to the original set state must be 10 μ s or more. Transition time of less than 10 μ s will result in an incorrect timeout detection.

(4) Detection of exceptional events

Specify whether you want detection of the following exceptional events to be used as a trace point.

- Violation of access protection
- Reading from a non-initialized memory area
- Stack access violation
- Performance-measurement overflow
- Realtime profile overflow
- Task stack access violation
- OS dispatch

(5) Specifying a delay value

If this checkbox is selected, tracing stops the specified number of bus cycles after the trace point is encountered.

The delay value is selectable as 0-M, 1-M, 2-M, 3-M or 4-M bus cycles (default: 0M).

Select the desired value from the Delay drop-down list box.

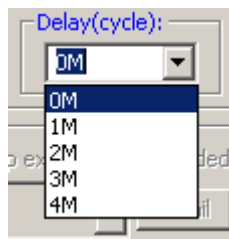

Figure 5.53 Selecting a delay value

5.9.6 Setting Extraction or Elimination Conditions



If the selected trace mode is Fill until stop, Fill until full or Fill around TP, you can specify a condition for capturing or not capturing information.

You can specify events so as to extract only the required portions or to eliminate non-required portions of the trace information.

(1) Extraction and elimination conditions

The following types of condition are available.

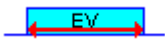
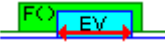
Table 5.22 Extraction and elimination conditions

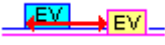
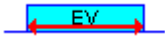
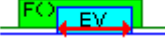
	Type		Description
Extraction		Between two events	Trace information is extracted from the cycle in which the event set as [Start event] occurs to the cycle preceding the event set as [End event] (information is not acquired for the cycle where [End event] occurs).
		Duration of an event	Trace information is extracted over the cycles corresponding to occurrence of the specified event.
		Duration of an event occurring in a subroutine	Trace information is extracted over the cycles corresponding to occurrence of the specified event within the specified address range (subroutine or function).
		Instruction accessing specific data	Information is extracted for instructions that access specified data.
Elimination		Between two events	Trace information is eliminated from the cycle in which the event set as [Start event] occurs to the cycle preceding the event set as [End event] (information is not acquired for the cycle where [End event] occurs).
		Duration of an event	Trace information is eliminated over the cycles corresponding to occurrence of the specified event.
		Duration of an event occurring in a subroutine	Trace information is eliminated over the cycles corresponding to occurrence of the specified event within the specified address range (subroutine or function).

Select the desired condition from the list box that is displayed when you select Capture or Do not capture in the Record condition group box of the Trace conditions dialog box.

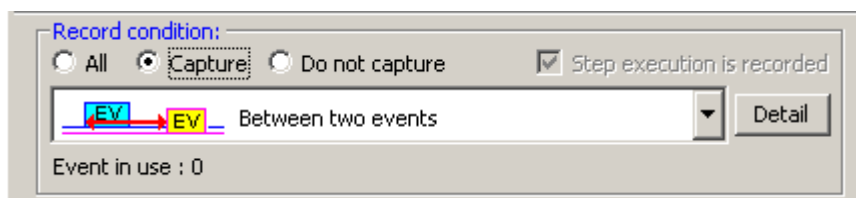

Figure 5.54 Record condition group box

Then click on the Detail button. The Event dialog box will appear.

CAUTION

When you specify conditions for extraction or elimination, you cannot select DIS (disassembly mode) or SRC (source mode) from Display Mode in the popup menu of the Trace window.

When you specify a data-access event as a condition for extraction or elimination, be sure to specify MCU bus as the access type.

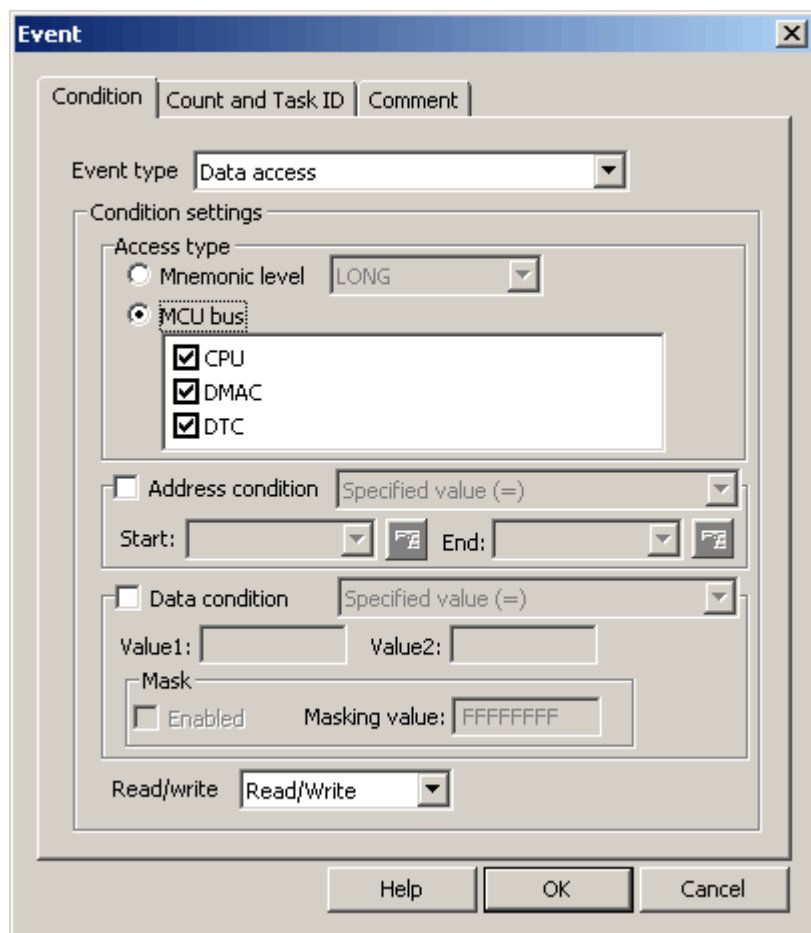

Figure 5.55 Event dialog box

5.9.7 Selecting the Type of Trace Information to be Acquired

Select the type of trace information to be stored in the trace memory. Make this selection on the Option page of the Trace conditions dialog box.

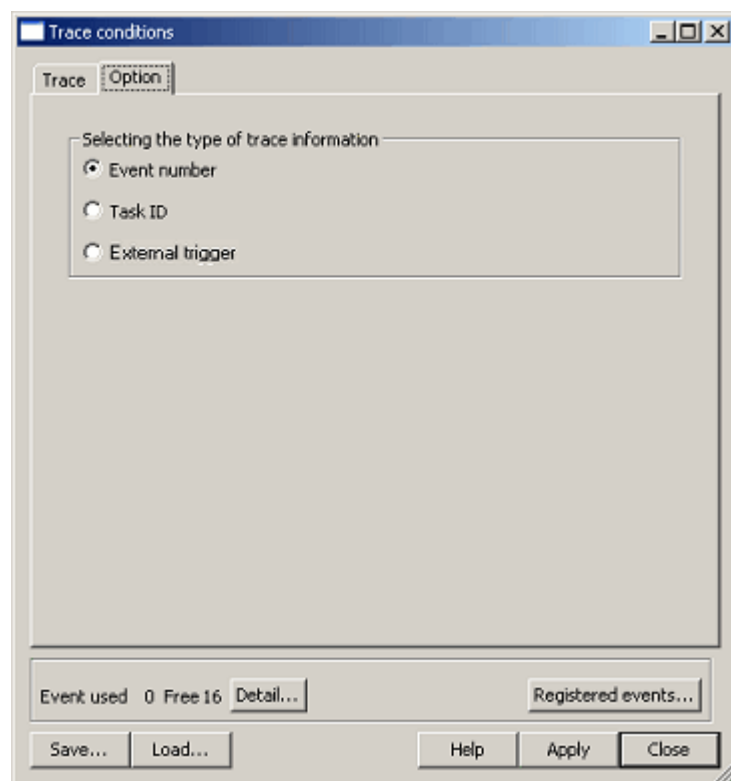

Figure 5.56 Trace conditions dialog box

Select which signal you want to acquire from three choices available: Event number, Task ID or External trigger. By default, Event number is selected.

CAUTION

If you want to view the history of tracing information on a realtime OS program, select Task ID.

5.9.8 Viewing Trace Results

To check trace results, open the Trace window. Trace results can be shown in one of the following display modes: bus, disassembly, source, or mixed. The display can be switched by changing the selection of Display Mode in the popup menu of the Trace window.

(1) Bus Display Mode

In the popup menu, select Display Mode -> BUS. Bus information is displayed for all traced cycles (this is the default display mode).

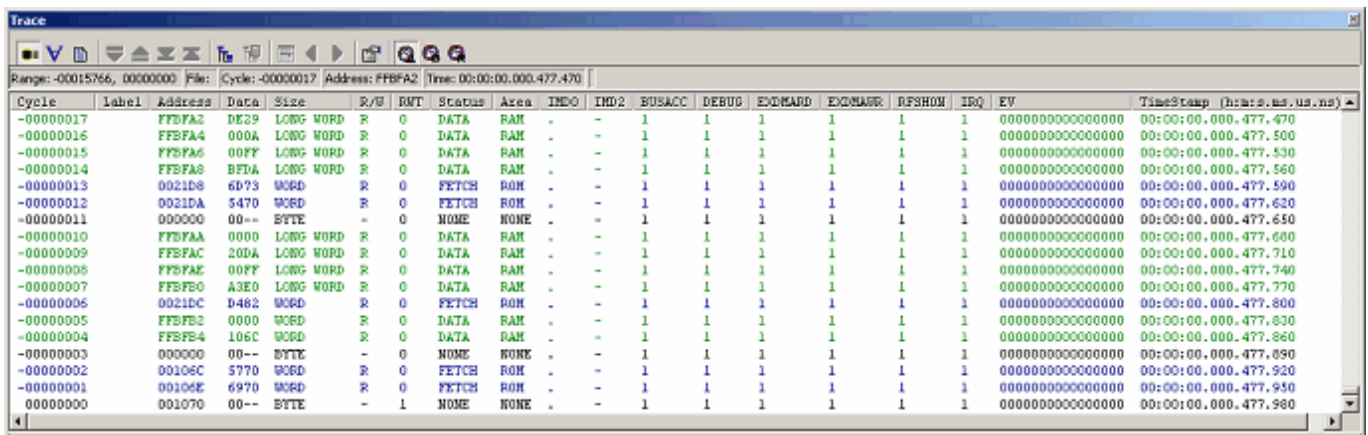

Figure 5.57 Trace window

(2) Disassembly Display Mode

From the popup menu, choose Display Mode -> DIS. This mode shows a disassembly of the machine-language instructions that have been executed.

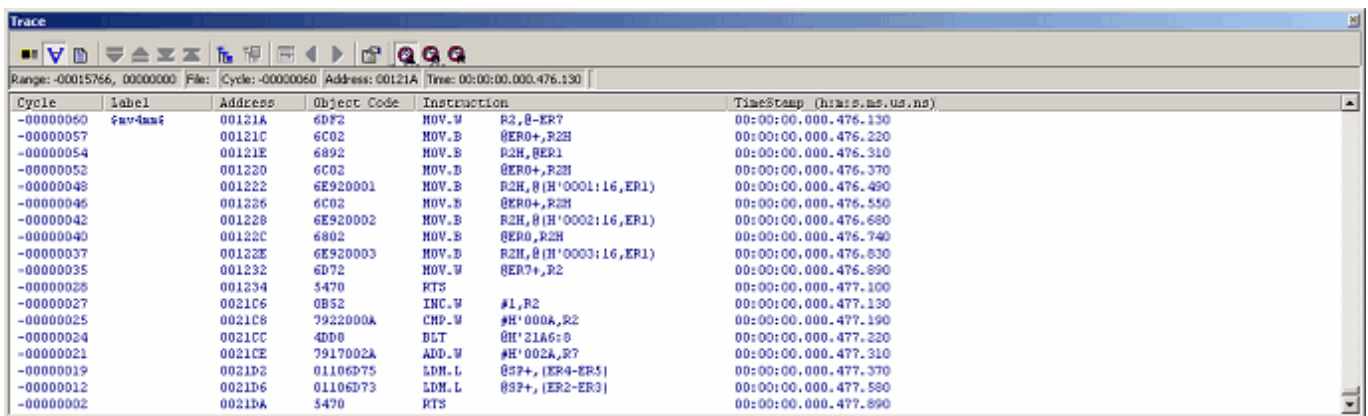

Figure 5.58 Trace window

(3) Source Display Mode

From the popup menu, choose Display Mode -> SRC. This mode shows the flow of execution of the source program.

You can check the flow of execution by stepping forwards and backwards through the source code from the current trace cycle.

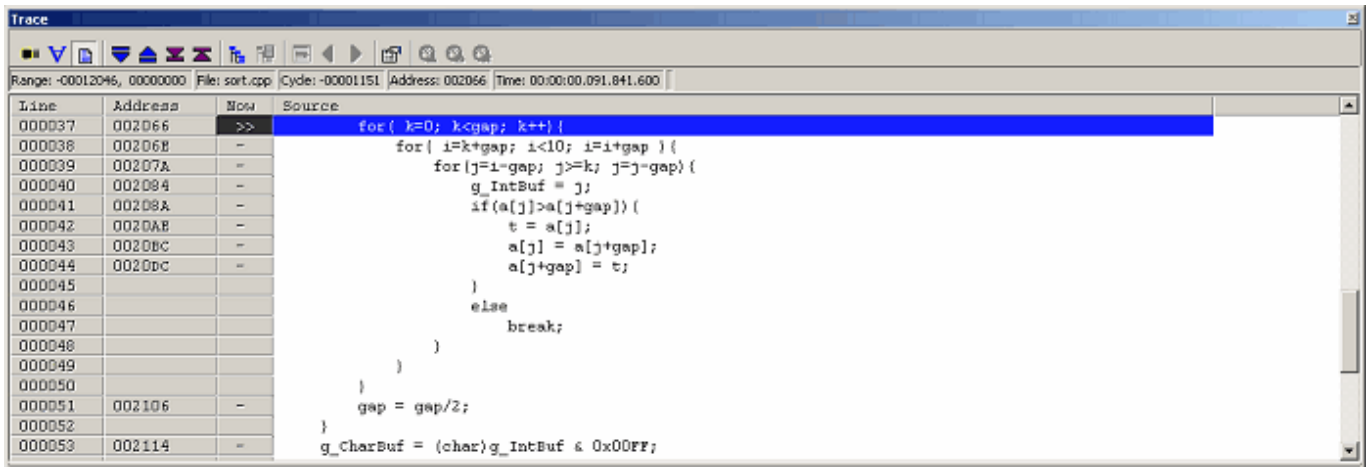

Figure 5.59 Source mode screen

(4) Mixed Display Modes

Two or all of the basic modes can be selected at the same time, providing mixed displays of bus, disassembly, and source information.

After choosing Display Mode -> BUS from the popup menu, select Display Mode -> DIS. This produces a mixed display of bus and disassembly modes.

In the same way, you can produce mixed displays of bus–source, disassembly–source, or bus–disassembly–source.

To revert to bus mode after viewing a bus–disassembly mixed display, reselect Display Mode -> DIS from the popup menu.

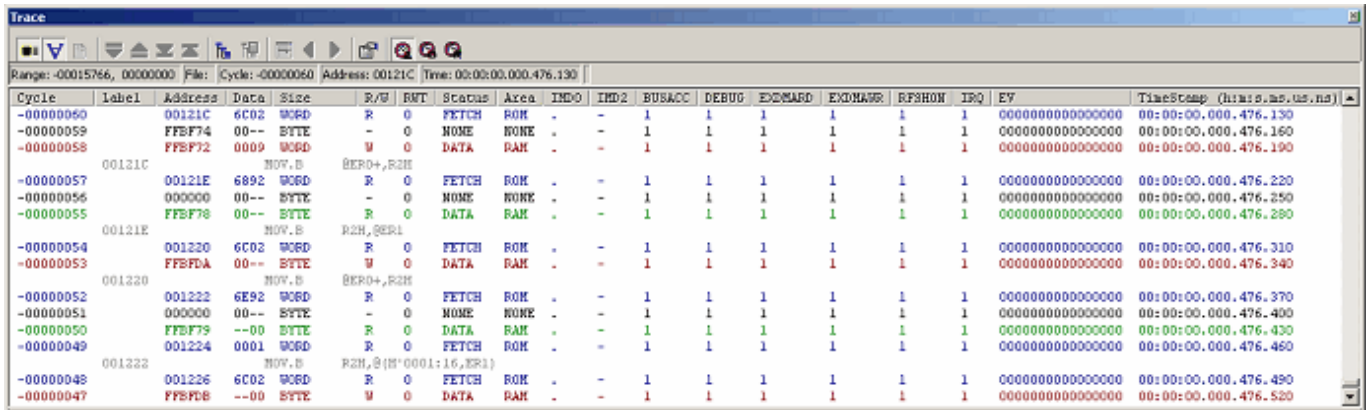

Figure 5.60 Trace window

5.9.9 Filtering Trace Information

Use the filtering facility to extract only the records you need from the acquired trace information. This facility is achieved by software filtering of the trace information that has been acquired by hardware.

Unlike "Capture/Do not Capture", where the conditions must be set before getting the trace information, the filter settings can be changed any number of times. This makes it easy to extract required information, significantly facilitating data analysis.

Filtering does not affect the trace memory, so that its contents remain intact.

Filtering is available when the selected trace mode is Fill until stop, Fill until full or Fill around TP and the selected display mode is bus or disassembly.

(1) Auto-filtering

To use the filtering facility, choose Auto Filter from the popup menu of the Trace window. When Auto Filter is turned on, each of the columns in the Trace window is marked with an auto-filter arrow [▼].

By simply clicking on the arrows [▼] and selecting desired conditions from the drop-down lists, you can filter the records to get those that meet the conditions. Selecting Option in the drop-down list brings up the Option dialog box. In this dialog box, you can set detailed conditions.

Items such as Address and Data do not have a manageably small fixed set of items, so the only entry in the drop-down list for these columns is Option... Selecting All returns the window to the non-filtered state.

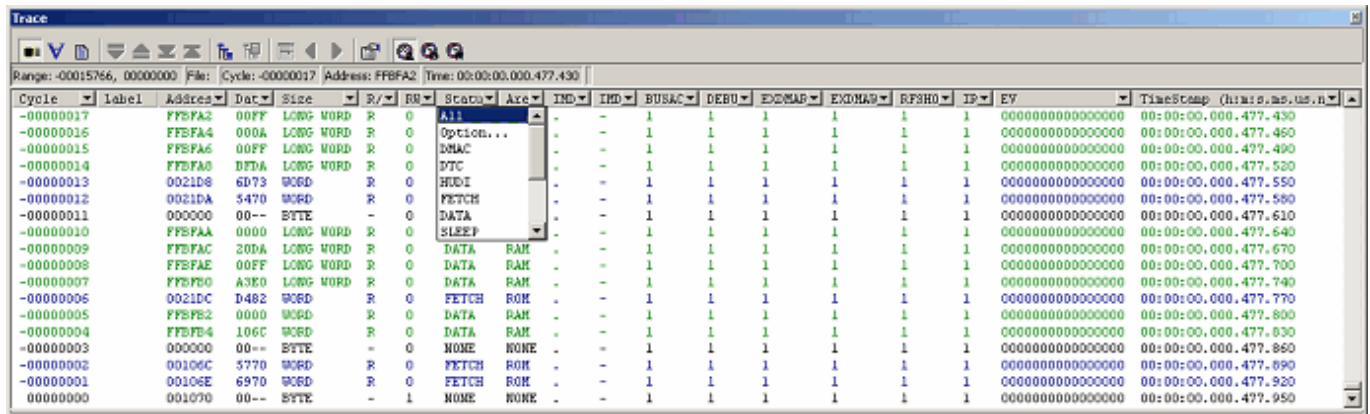

Figure 5.61 Trace window

If you switch the display mode to disassembly or source after filtering records in bus mode, Auto Filter is deselected. Similarly, if you switch the display mode to bus or source after filtering records in disassembly mode, Auto Filter is deselected.

If you have specified multiple items in an Option dialog box, these items constitute an OR condition for use in filtering.

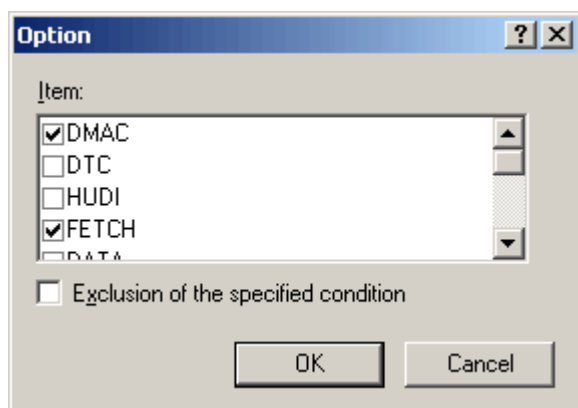



Figure 5.62 Option dialog box

5.9.10 Searching for Trace Records

You can search the acquired trace information for a specific trace record.

To search for trace records, use the Find dialog box. Open this by choosing Find -> Find from the popup menu of the Trace window or clicking on the Find toolbar button  in the toolbar.

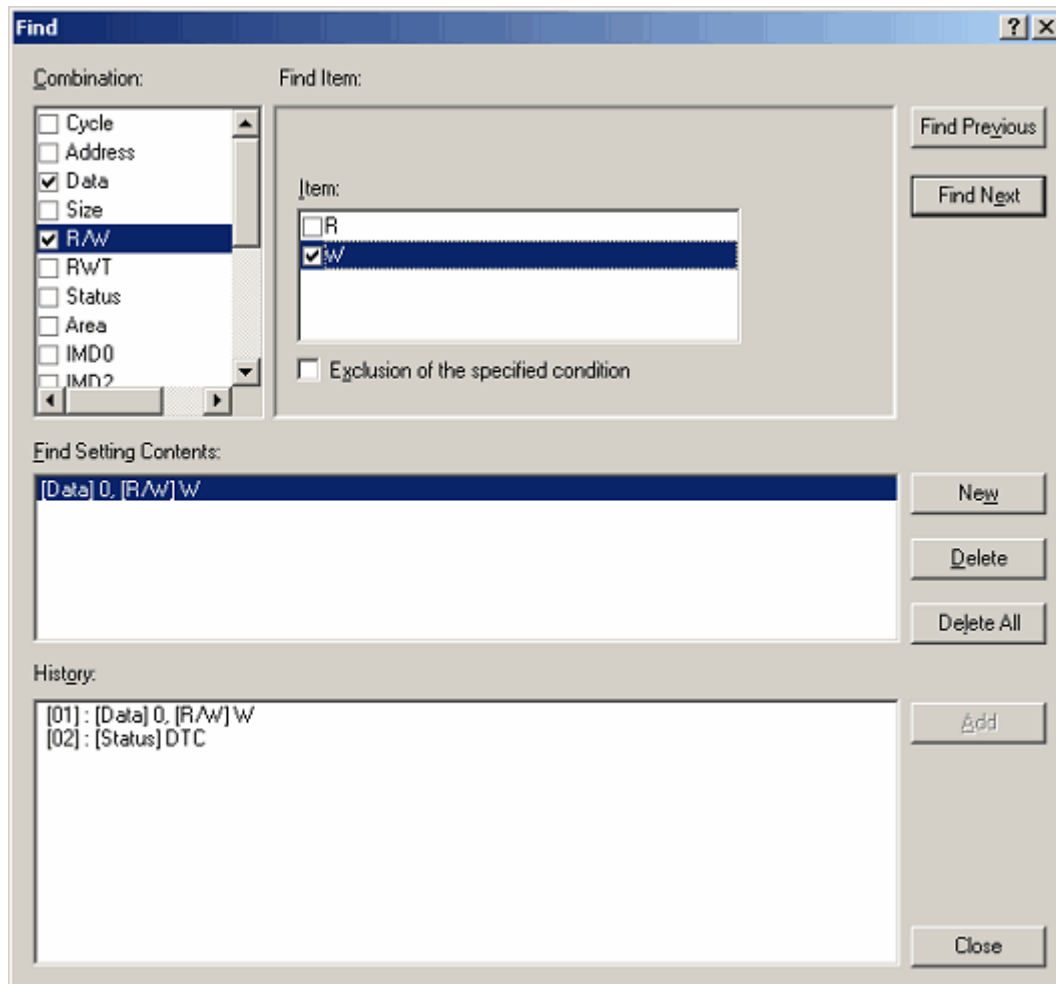

Figure 5.63 Find dialog box

In the Combination column, select the checkboxes for the items of trace information for which you want to set up criteria.

The criteria that correspond to the currently selected items appears in the Find Item column. Select the required criteria.

If you have checked more than one item in the Combination column, set criteria for each of them. The items you have set are used as an AND condition.

The criteria you have set are shown in Find Setting Contents.

After setting the criteria, click the Find Previous or Find Next button to start a search. Searching then proceeds forwards or backwards through the trace records from the line you have clicked in the Trace window (the line highlighted in blue).

When a matching trace record is found, the corresponding line is highlighted in the Trace window. If no matching trace records are found, a message dialog box is displayed.

When an instance of the trace record was successfully found, choose Find Previous or Find Next from the popup menu. This initiates a search for the next instance of the trace record.

(1) Search history

The search conditions that have been used are recorded in the History column and are retained throughout a session of the High-performance Embedded Workshop.

If you want to perform a search again, choose the corresponding line from the history and click on the Add button to initiate a new search for trace information with the same condition.

Up to the last 10 searches are retained in the search history.

(2) OR search

You can perform a search with two or more search conditions combined in an OR condition.

To set an OR condition, begin by setting the first condition (shown on the first line in the Find Setting Contents column) and then click on the New button.

Then enter the second condition. At this time, the second condition is added as a second line in the Find Setting Contents column.

In this case, the search is for lines satisfying the logical OR of the conditions on the first and second lines in the Find Setting Contents column.

Up to 16 conditions (16 lines) can be set.

CAUTION

Conditions set on the same line of the Find Setting Contents column are treated as an AND condition.

5.9.11 Saving Trace Information in Files

To save trace information in a file, choose File -> Save from the popup menu or click on the Save toolbar button . The trace information displayed in the Trace window is saved in a binary or text format.

(1) Saving in the binary format

To save trace information in the binary format, choose "Trace Data File: Memory Image (*.rtt)" in the Save As Type list box of the dialog box that is displayed when you choose File -> Save from the popup menu.

When information is saved in the binary format, information for all cycles is saved. This type of file can be loaded back into the Trace window.

(2) Saving in the text format

To save trace information in the text format, choose "Text Files: Save Only (*.txt)" in the Save As Type list box of the dialog box that is displayed when you choose File -> Save from the popup menu.

When information is saved in the text format, saving of information for a range of cycles can be specified. This type of file can only be saved and cannot be loaded back into the Trace window.

5.9.12 Loading Trace Information from Files

To load trace information from a file, choose File -> Load from the popup menu or click on the Load toolbar button .

Specify a trace information file that was saved in the binary format. The current results of tracing are overwritten.

Before loading a file saved in the binary format, switch to the trace mode in which the saved trace information was acquired. This switching should be performed in the Trace conditions dialog box that is displayed when you choose Acquisition from the popup menu of the Trace window.

If the current trace mode differs from that in which the saved information was acquired, an error occurs. Trace information files saved in the text format cannot be loaded back into the Trace window.

5.9.13 Temporarily Stopping Trace Acquisition

To temporarily stop the acquisition of trace information during user program execution, choose Trace -> Stop from the popup menu of the Trace window or click on the Stop toolbar button .

Trace acquisition will be stopped, with the trace display updated. Use this function when you only want to stop acquisition and check the trace information but not to stop program execution.

5.9.14 Restarting Trace Acquisition

If you want to restart trace acquisition after it has temporarily been stopped during user program execution, choose Trace ->

Restart from the popup menu of the Trace window or click on the Restart toolbar button .

5.9.15 Switching the Timestamp Display

The display of timestamps in the Trace window can be switched to absolute time, differential time or relative time. In the initial state, the timestamps are displayed in absolute time.

(1) Absolute time

Choose Time -> Absolute Time from the popup menu or click on the Absolute Time toolbar button . The displayed timestamps will be displayed in absolute time since the program started running.

(2) Differential time

Choose Time -> Differences from the popup menu or click on the Differences toolbar button . Each displayed timestamp is the difference in time from the preceding cycle.

(3) Relative time

Choose Time -> Relative Time from the popup menu or click on the Relative Time toolbar button . The displayed timestamps are times relative to the time of a specified cycle.

5.9.16 Viewing the History of Function Execution

To view the history of function execution extracted from the acquired trace information, choose Function Execution History ->

Function Execution History from the popup menu or click on the Function Execution History toolbar button .

An upper pane will be opened in the Trace window (the pane is blank by default).

When you choose Analyze Execution History from the popup menu or click on the Analyze Execution History toolbar button

, the emulator starts analyzing the history of execution history from the end of the results of tracing. The results of analysis are displayed in a tree structure.

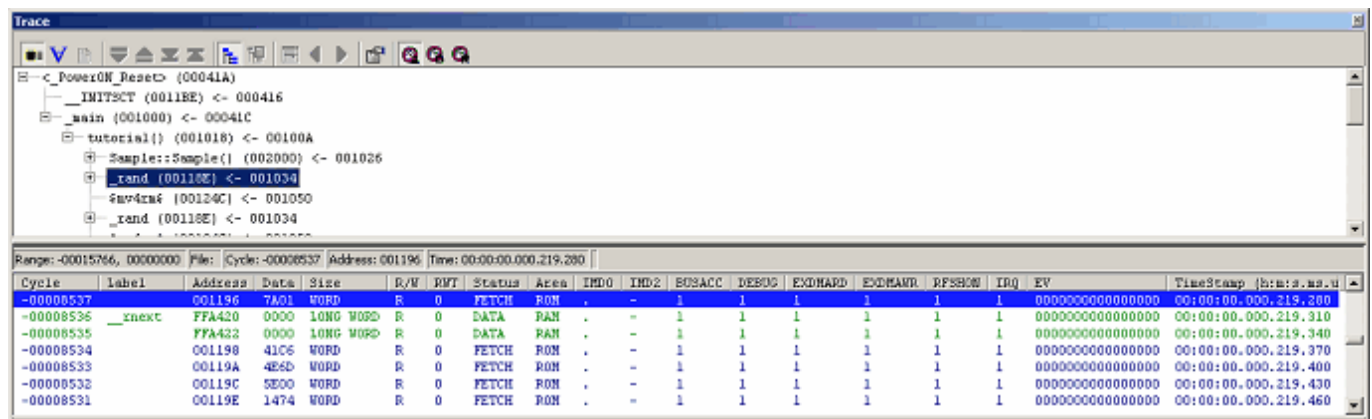

Figure 5.64 Trace window

The lower pane of the window shows results of tracing from the cycle in which the function selected in the upper pane was called.

Results in the lower pane can be displayed in disassembly, source, or a mixed mode.

CAUTION

If extraction or elimination conditions are specified, the history of function execution cannot be displayed.

If the 'repeat fill until stop' or 'repeat fill until full' mode is selected, the history of function execution cannot be displayed.

5.9.17 Viewing the History of Task Execution

The history of task execution can only be displayed when you are debugging a realtime OS program.

Furthermore, to view the history of task execution, you need to select Task ID on the Option page of the Trace conditions dialog box that is displayed when you choose Acquisition from the popup menu of the Trace window.

To show the history of function execution extracted from the acquired trace information, choose Show Function Execution

History from the popup menu or click on the Show Function Execution History toolbar button .

The upper pane of the window will be opened (the pane is blank by default).

When you choose Analyze Execution History from the popup menu that is displayed when you right-click in the upper pane or

click on the Analyze Execution History toolbar button , the emulator shows the history of task execution.

In the history of task execution, note that function calls from within tasks are not displayed in a tree structure. Only the order in which the functions were executed is displayed.

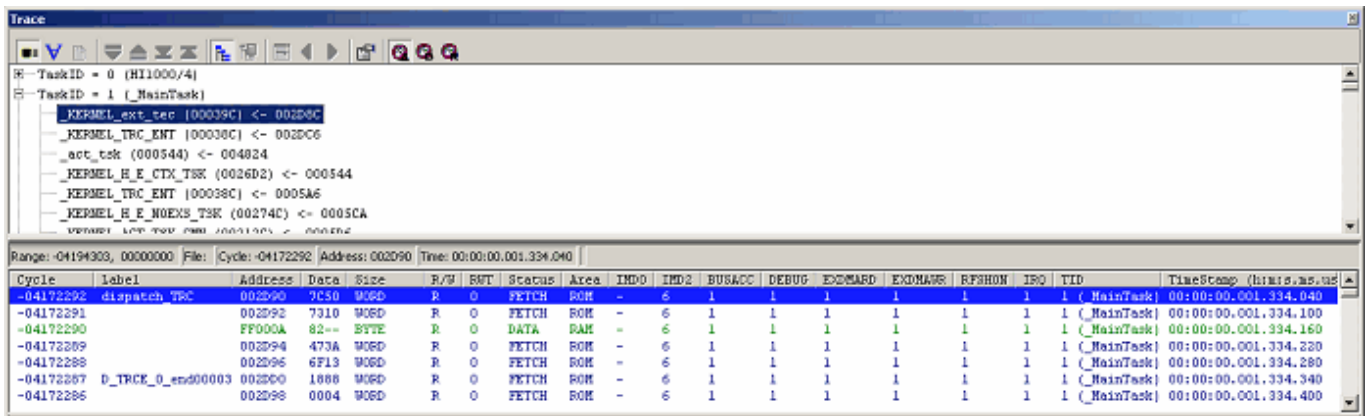

Figure 5.65 Trace window

The lower pane of the window shows results of tracing from the cycle in which the task selected in the upper pane was called. The lower pane of the window can show trace results in disassembly, source, or a mixed mode.

CAUTION

If extraction or elimination conditions are specified, the history of task execution cannot be displayed.

If the 'repeat fill until stop' or 'repeat fill until full' mode is selected, the history of task execution cannot be displayed.

5.10 Measuring Performance

5.10.1 Measuring Performance

The performance measurement facility of the emulator is capable of measuring the maximum, minimum, average and total execution times and the number of passes for each of up to eight specified sections of the user program, and shows ratios of time relative to the overall execution time (Go–Break) as percentages and graphically.

Since this facility uses the emulator's performance measurement circuit to measure the execution time, it does not impede execution of the user program.

Performance measurement conditions cannot be manipulated during program execution.

5.10.2 Viewing the Results of Performance Measurement

Results of measurement are displayed in the Performance Analysis window.

To open the Performance Analysis window, choose Performance → Performance Analysis from the View menu or

click on the Performance Analysis toolbar button .

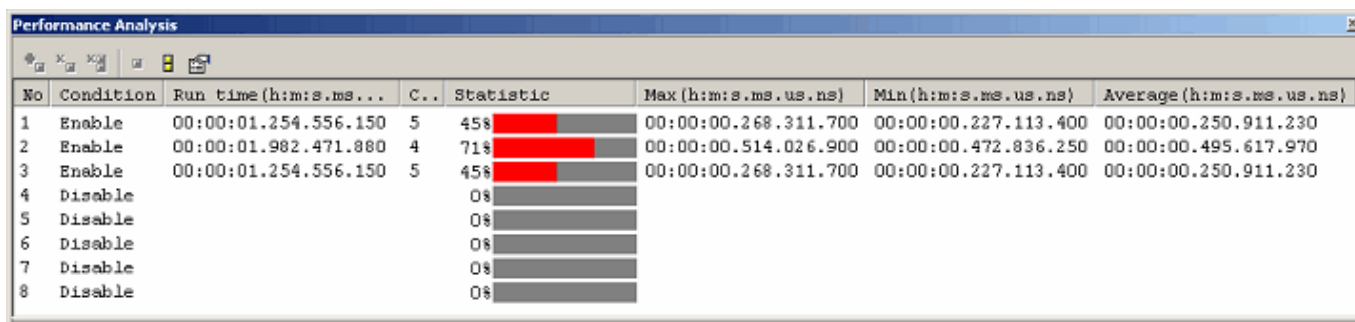

No	Condition	Run time (h:m:s.ms...)	C..	Statistic	Max (h:m:s.ms.us.ns)	Min (h:m:s.ms.us.ns)	Average (h:m:s.ms.us.ns)
1	Enable	00:00:01.254.556.150	5	45%	00:00:00.268.311.700	00:00:00.227.113.400	00:00:00.250.911.230
2	Enable	00:00:01.982.471.880	4	71%	00:00:00.514.026.900	00:00:00.472.836.250	00:00:00.495.617.970
3	Enable	00:00:01.254.556.150	5	45%	00:00:00.268.311.700	00:00:00.227.113.400	00:00:00.250.911.230
4	Disable			0%			
5	Disable			0%			
6	Disable			0%			
7	Disable			0%			
8	Disable			0%			

Figure 5.66 Performance Analysis window

The Performance Analysis window shows the ratios of execution time per condition you have set for the most recent execution of the program as percentages and graphically.

Any unnecessary columns in this window can be hidden.

To hide any column, right-click in the header column and select the column you want to hide from the popup menu.

To view any hidden column, reselect that column from the popup menu again.

The contents displayed in this window are listed below.

Table 5.23 Columns and contents

Column	Description
No	Numbers from 1–8 that are assigned to the measurement sections set up in the Performance Analysis Conditions dialog box. Click Settings on the popup menu to open the Performance Analysis Conditions dialog box.
Condition	The entry is “Enable” when a measurement condition is set in the Performance Analysis Conditions dialog box. Otherwise, the entry is “Disable”.
Run time (h:m:s.ms.us.ns)	Cumulative execution time. This is the cumulative total of measured execution times.
Count	Shows the number of times measurement for the section has proceeded.
Statistic	Shows the ratio of the cumulative execution time relative to the Go–Break execution time. [Ratio calculation formula] (Cumulative execution time / Go–Break cumulative execution time) * 100
Max (h:m:s.ms.us.ns)	Maximum execution time per measurement performed
Min (h:m:s.ms.us.ns)	Minimum execution time per measurement performed
Average (h:m:s.ms.us.ns)	Average execution time per measurement performed

5.10.3 Setting Performance Measurement Conditions

In the Performance Analysis window, select the line of a section number to use for the condition and choose Set from the popup menu. The Performance Analysis Conditions dialog box will be displayed.

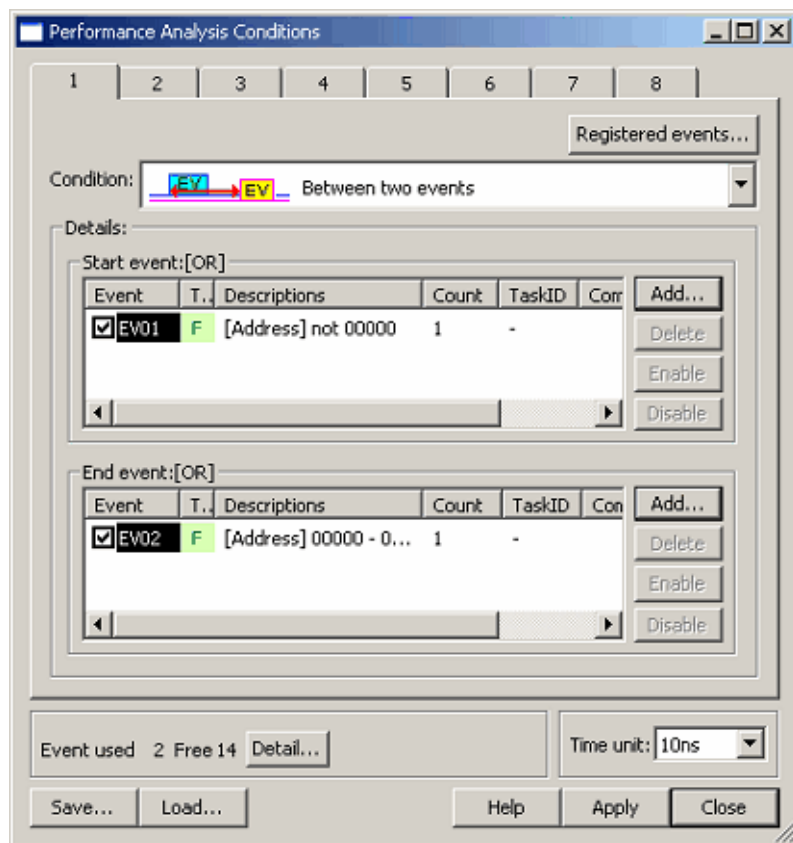

Figure 5.67 Performance Analysis Conditions dialog box

(1) Setting measurement conditions

The measurement mode can be selected from among the four choices listed in Table 5.24. Select one measurement mode for one section. Use events to specify the beginning and end of a section. The value of Count is fixed to 1. The event count is always 1, even if you have attempted to specify some other value.

Table 5.24 Measurement modes





	<p>[Disabled] Measurement is disabled.</p>
	<p>[Between two events]</p>  <p>Figure 5.68 Between two events</p> <p>Measurement is performed between the start event and the end event. Specifically, the time execution takes and number of passes through the range between the start event and the end event are measured. The measurement of time starts when the start event occurs and is suspended when the end event occurs. The number of passes through the section is incremented by one each time the pair of the start event and end event for the specified range occur.</p> <p>Start event: One or multiple events can be set. End event: One or multiple events can be set.</p>
	<p>[Period of an event]</p>  <p>Figure 5.69 Period of an event</p> <p>Measurement is performed during the event. Namely, the period between occurrences of the event the number of times it occurs are measured. The time from one occurrence of the event to the next is measured as one instance. The number of times is incremented by one each time the event occurs.</p> <p>Event: Only one event point can be set.</p>

Table 5.25 Measurement modes (continued)

[Interrupt-disabled range between two events]

Start event:[OR]

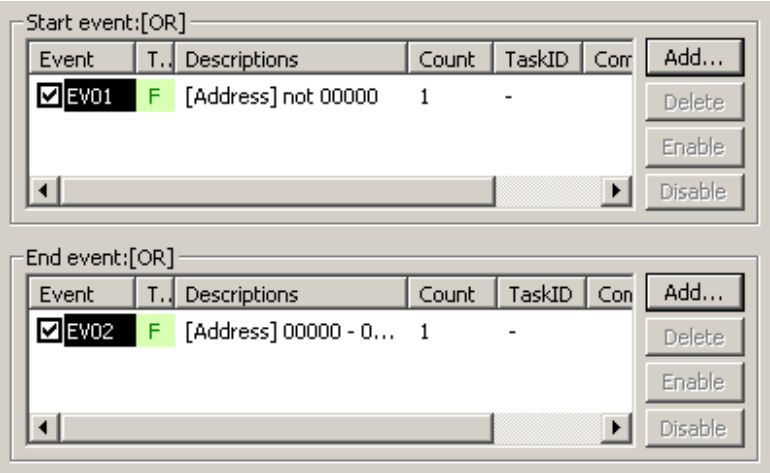
Event	T.	Descriptions	Co...	Ta...	Comm	
<input checked="" type="checkbox"/> EV01	F	[Address] outside 0...	1	-		<input type="button" value="Add..."/> <input type="button" value="Delete"/> <input type="button" value="Enable"/> <input type="button" value="Disable"/>

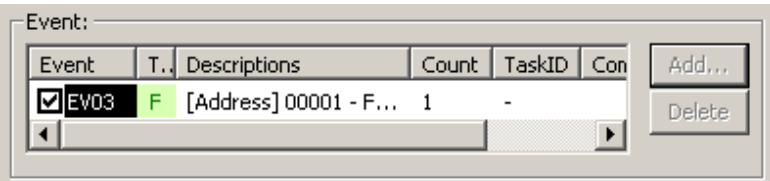
End event:[OR]

Event	T.	Descriptions	Co...	Ta...	Comm	
<input checked="" type="checkbox"/> EV02	F	[Address] 00000 - F...	1	-		<input type="button" value="Add..."/> <input type="button" value="Delete"/> <input type="button" value="Enable"/> <input type="button" value="Disable"/>

Figure 5.70 Interrupt-disabled range between two events

Measurement is of ranges over which interrupts are disabled from the start event to the end event. Specifically, the intervals over which interrupts are disabled and number of times interrupts are disabled within the range specified by Start event and End event are measured. The measurement of time starts when interrupts are disabled and is suspended when interrupts are re-enabled. The number of times is incremented by one each time interrupts are disabled.

Start event: One or multiple events can be set.
 End event: One or multiple events can be set.

[CAUTION]

To measure the execution time of a function (maximum, minimum or average execution time of a function), use Between two events.

Specify fetching from the first address of the function as the start event and fetching from the exit point of the function (point corresponding to the line containing the function's return statement) as the end event. If there is more than one exit point, set a fetch condition that covers each of them as the end event.

(2) Selecting the unit of measurement

This setting applies in common to all 8 sections. The following units of measurement are available:

10 ns (default), 20 ns, 40 ns, 80 ns, 160 ns, 1.6 μs

The maximum measurement time varies with the unit of measurement you set.

5.10.4 Starting Performance Measurement

When the user program is run, performance measurement is automatically started according to the conditions set on performance measurement.

When the user program is halted, the results of measurement are displayed in the Performance Analysis window.

When execution of the user program is halted and then restarted without changing the conditions of measurement, the newly measured times are added to the previous values.

To perform the measurements afresh, clear the results of measurement before running the program.

5.10.5 Clearing Performance Measurement Conditions

Select the measurement condition you want to clear in the Performance Analysis window and then choose Set from the popup menu to display the Performance Analysis Conditions dialog box. In the Performance Analysis Conditions dialog box, disable the condition you want to clear.

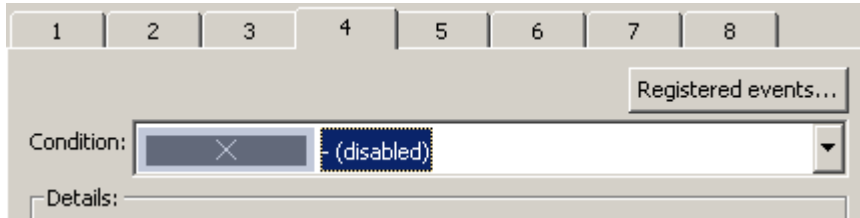

Figure 5.71 Performance Analysis Conditions dialog box

5.10.6 Clearing Results of Performance Measurement

In the Performance Analysis window, select the section corresponding to the results you want to clear and then choose Clear Data from the popup menu. The results of measurement for the selected section will be cleared. To clear all results of measurement, choose Clear All Data from the popup menu.

5.10.7 Maximum Time of Performance Measurement

(1) Maximum measurement time

The timer used for performance measurement is comprised of a 40-bit counter.

The maximum measurement time varies with selected unit of measurement.

To select the unit of measurement, use the Time unit list box of the Performance Analysis Conditions dialog box.

The maximum measurable times for the respective units are listed in the table below.

Table 5.26 Maximum measurable times

Resolution	Maximum measurable time
10 ns	Approx. 3 hours, 03 minutes, 15 seconds
20 ns	Approx. 6 hours, 06 minutes, 30 seconds
40 ns	Approx. 12 hours, 13 minutes, 00 seconds
80 ns	Approx. 24 hours, 26 minutes, 00 seconds
160 ns	Approx. 48 hours, 52 minutes, 01 seconds
1.6 μ s	Approx. 488 hours, 40 minutes, 18 seconds

CAUTION

Note that results of performance measurement carry an error equal to ± 1 times the resolution (e.g. ± 20 ns when the resolution is 20 ns).

(2) Maximum measured number of passes

Numbers of passes through sections are measured by a 32-bit counter. Measuring up to 4,294,967,295 passes is thus possible.

5.11 Measuring Code Coverage

5.11.1 Measuring Code Coverage

Code coverage refers to measures of the condition of a program in terms of 'digestion' by tests, i.e., the degree of thoroughness of tests of the software code (and the paths within it).

Information on instruction execution is displayed for the C/C++ and assembly-language levels.

This function collects information on instruction execution without causing execution of the program to break. Therefore, measuring code coverage does not affect the realtime characteristic of user-program execution.

The results of coverage are updated when a break is encountered.

The E100 emulator supports C0 (instruction) coverage and C1 (branch) coverage.

Table 5.27 Code coverage definition

C0: Instruction coverage	All statements within the code are executed at least once.
C1: Branch coverage	All branches within the code are executed at least once.

The E100 emulator comes with up to 2 Mbytes of code-coverage memory for C0 level coverage and up to 1 Mbyte of code-coverage memory for C0 + C1 level coverage.

With the initial settings, code-coverage memory is automatically allocated to addresses in the ROM area, in that order..

5.11.2 Opening the Code Coverage Window

Choose Code -> Code Coverage from the View menu or click on the Code Coverage toolbar button .

The Code Coverage window is initially empty.

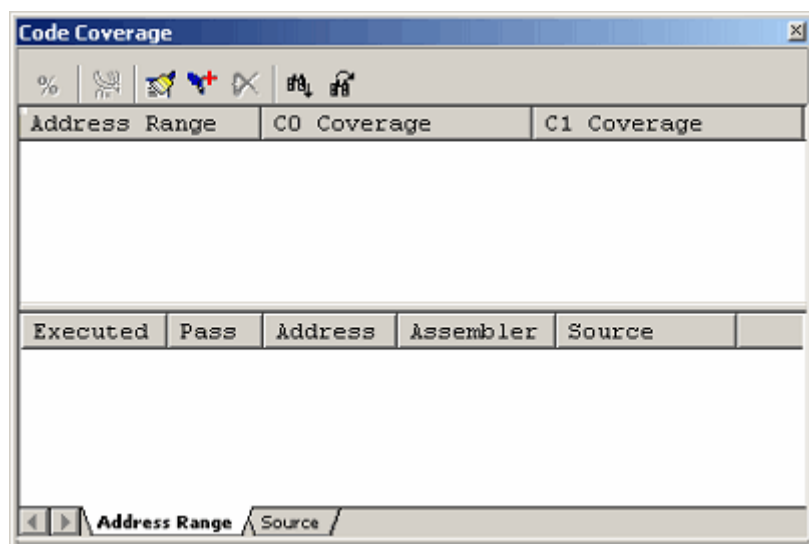

Figure 5.72 Code Coverage window

(1) Measurement method

The Code Coverage window has two sheets.

Table 5.28 Sheets of the Code Coverage window

Sheet	Description
Address Range	Measurement is performed on any address range.
Source	Measurement is performed on a specified source file

The respective sheets permit registration of multiple ranges.

Up to two instances of the Code Coverage window can be open at the same time.

5.11.3 Allocating Code Coverage Memory (Hardware Resource)

(1) Memory allocation

Before code coverage can be measured, code-coverage memory must be assigned to the target address range. Coverage data can only be obtained from an address range to which memory has been allocated.

To allocate code coverage memory, use the Allocation of Code Coverage Memory dialog box.

To open this dialog box, select [Hardware Settings...] from the popup menu of the Code Coverage window.

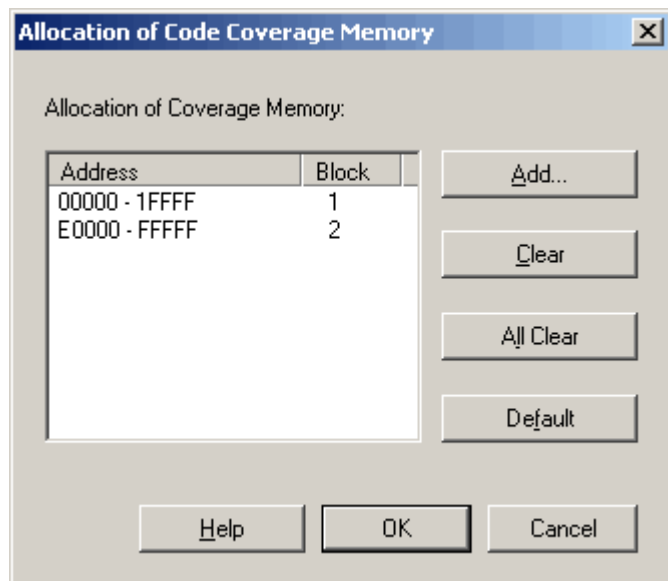

Figure 5.73 Allocation of Code Coverage Memory dialog box

When using C0 level coverage and C1 level coverage, you can specify a number of blocks from 1 to 8 (for a total of up to 2 Mbytes), each beginning on a 256-Kbyte boundary, and a number of blocks from 1 to 8 blocks (for a total of up to 1 Mbyte), each beginning on a 128-Kbyte boundary, as areas for the respective forms of code coverage measurement.

The blocks may be contiguous or non-contiguous.

With the initial settings, the coverage memory is automatically allocated to addresses in the ROM area.

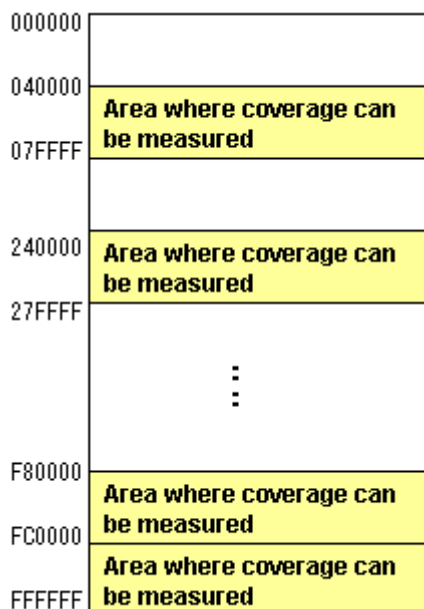

Figure 5.74 Schematic view of coverage memory allocation

(2) Changing memory allocation

When the allocation of coverage memory is changed, the coverage data acquired from the target address ranges prior to the change is retrieved from coverage memory into a dedicated coverage buffer.

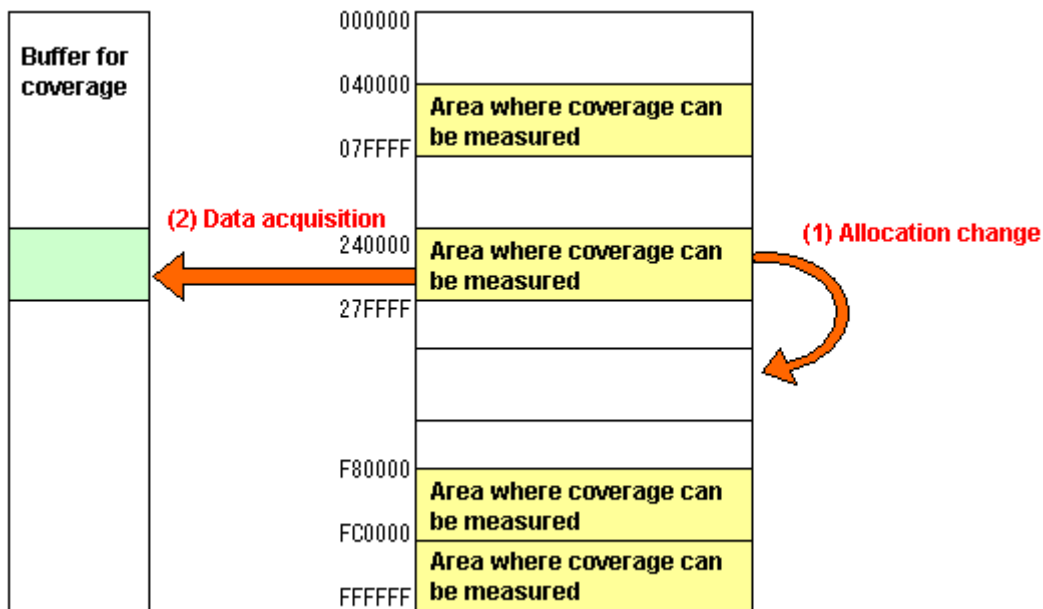

Figure 5.75 Schematic view of a change in coverage memory allocation

Acquired coverage information is accumulated in the coverage buffer until it is cleared by the user. However, coverage information is not updated for areas to which coverage memory is not allocated.

The coverage information shown in the Code Coverage window includes the information from the contents of the coverage buffer.

5.11.4 Code Coverage in an Address Range

The Address Range sheet shows the code-coverage information (C0 coverage and C1 coverage) acquired by the emulator from a user-specified address range.

Multiple address ranges can be registered.

An address range larger than 2 Mbytes or even an area to which no coverage memory has been allocated can be specified. However, when coverage memory has not been allocated to an area, coverage information on that area is not updated.

Areas for which coverage information is not updated are grayed-out.

An example display is shown below.

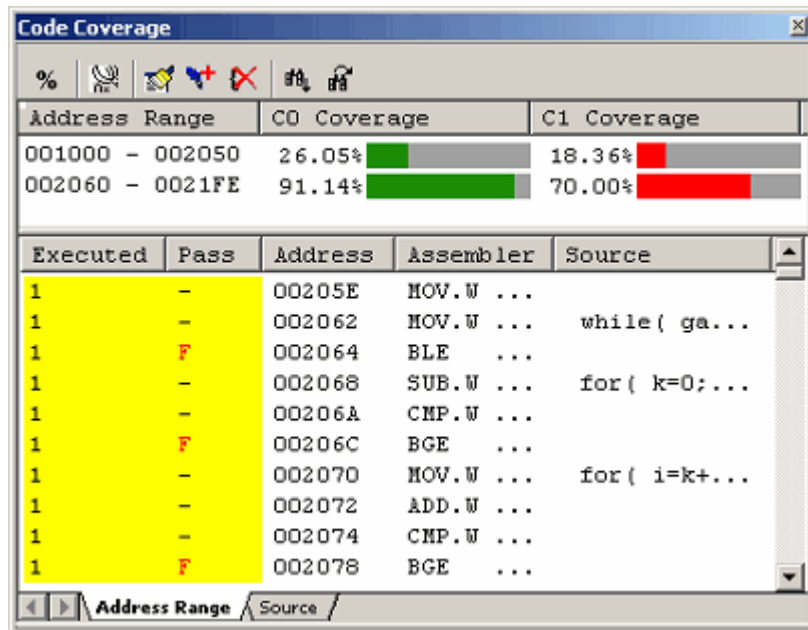

Figure 5.76 Code Coverage window (address specification)

The Code Coverage window is vertically divided in two by the splitter.

The upper pane shows the address ranges to be measured, and the degree of C0 coverage and C1 coverage.

Table 5.29 Contents of the upper pane of the Code Coverage window

[Address Range]	Address range for which coverage is measured
[C0 Coverage]	C0 coverage as a percentage and graph
[C1 Coverage]	C1 coverage as a percentage and graph

The lower pane shows a detailed (assembly-language level) view of the address range selected in the upper pane.

Table 5.30 Contents of the lower pane of the Code Coverage window

[Executed]	1: The instruction was executed. 0: The instruction was not executed.
[Pass]	Condition for execution of a conditional branch instruction. T: The condition was satisfied. F: The condition was not satisfied. T/F: The condition was satisfied in one case and not satisfied in another.
[Address]	Address of the instruction
[Assembler]	Disassembled program
[Source]	C/C++ or assembly source program

Acquired coverage information is accumulated in memory until it is cleared by the user.

When you double click on an assembler instruction in the Address Range sheet, the corresponding source code is shown in the Editor window.

Be aware that the source code will not be displayed in the cases listed below.

- A source file that corresponds to the assembler line does not exist.
- No source line corresponds to the assembler line.
- Where no debugging information was included, such as when the assembler line is for a library.

5.11.5 Code Coverage in a Source File

The Source sheet shows the code-coverage information (C0 coverage and C1 coverage) acquired by the emulator from a user-specified source file.

Multiple source files can be registered.

A source file larger than 2 Mbytes or even an area to which no coverage memory has been allocated can be specified.

However, when coverage memory has not been allocated for a portion of the code, coverage information on that area is not updated.

Address lines where coverage information is not updated are grayed-out.

An example display is shown below.

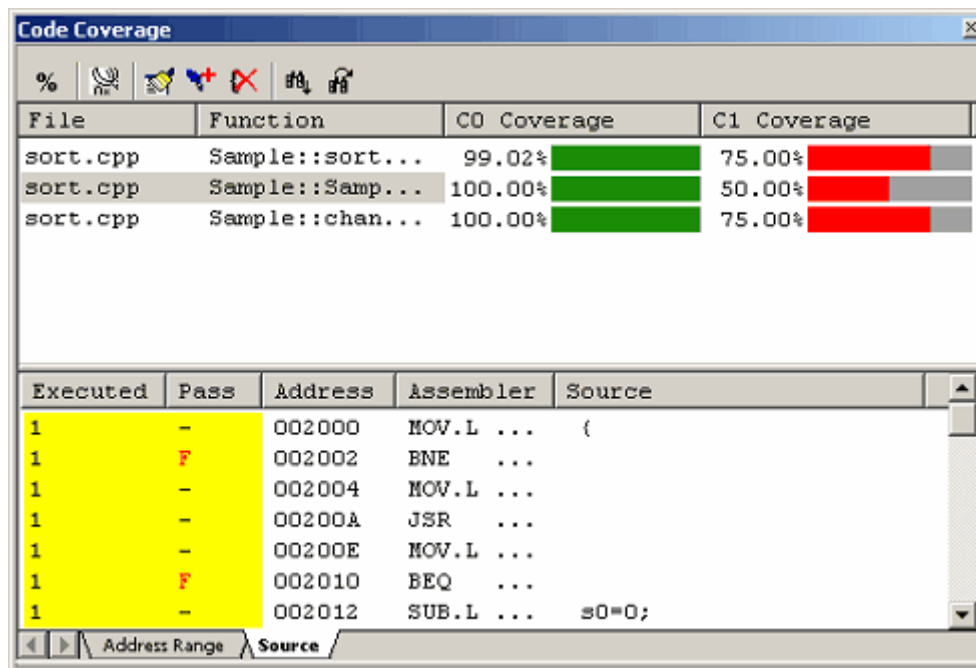

Figure 5.77 Code Coverage window (source file specification):

The Code Coverage window is vertically divided in two by the splitter.

The upper pane shows the address ranges to be measured (file and function names) and C0 coverage.

Table 5.31 Contents shown in the upper pane of the Code Coverage window

[File]	File name
[Function]	Function name
[C0 Coverage]	C0 coverage as a percentage and graph
[C1 Coverage]	C1 coverage as a percentage and graph

The lower pane shows a detailed (assembly-language level) view of the address range selected in the upper pane.

Table 5.32 Contents of the lower pane of the Code Coverage window

[Executed]	1: The instruction was executed. 0: The instruction was not executed.
[Pass]	Condition for execution of a conditional branch instruction. T: The condition was satisfied. F: The condition was not satisfied. T/F: The condition was satisfied in one case and not satisfied in another.
[Address]	Address of the instruction
[Assembler]	Disassembled program
[Source]	C/C++ or assembly source program

The acquired coverage information is accumulated in memory until it is cleared by the user.

5.11.6 Showing Percentages and Graphs

After the program has stopped, right-click in the upper pane of the Code Coverage window and choose Percentage from the popup menu. The emulator will start calculating C0 (instruction) coverage and C1 (branch) coverage for each address range. When the calculation is completed, coverage information is displayed in the upper pane as percentages and graphs.

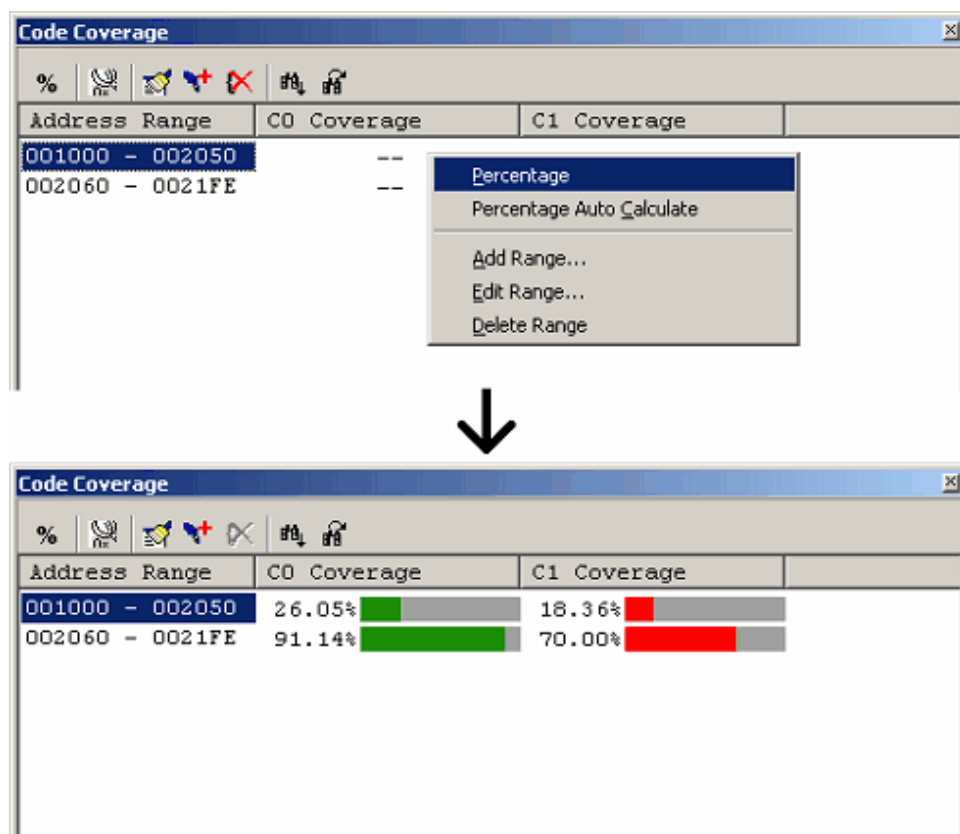

Figure 5.78 Percentages Shown in the Code Coverage window

If you have selected [Percentage Auto Calculate] in the popup menu, the emulator calculates the C0 coverage of the selected address ranges and displays the result every time there is a break in user program execution.

CAUTION

While [Percentage Auto Calculate] is active, stepping may take more time because the emulator calculates the coverage every time there is a break in user program execution. The larger the areas specified for coverage measurement, the longer the calculation of percentages takes. In cases where the speed of debugging must be given priority, deselect [Percentage Auto Calculate].

5.11.7 Sorting Coverage Data

Clicking on a header column in the upper pane of the Code Coverage window allows the coverage data to be sorted.

(1) Clicking on the File column

The data can be sorted by file name. Lines for the same file are sorted by function name.

Example:

File	Function	C0 Coverage
file1.cpp	func1	40% ■■■■
file1.cpp	func2	10% ■
file1.cpp	func3	80% ■■■■■■■■
file1.cpp	func4	70% ■■■■■■■■
file2.cpp	func1	20% ■■
file2.cpp	func2	60% ■■■■■■
file2.cpp	func3	90% ■■■■■■■■
file3.cpp	func1	0%
file3.cpp	func2	30% ■■■
file3.cpp	func3	10% ■

(2) Clicking on the C0 Coverage column

The data can be sorted by coverage rate.

Clicking on the column once sorts the values into descending order. Clicking on the column a second time sorts the values into ascending order.

Example:

File	Function	C0 Coverage
file2.cpp	func3	90% ■■■■■■■■
file1.cpp	func3	80% ■■■■■■■■
file1.cpp	func4	70% ■■■■■■■■
file2.cpp	func2	60% ■■■■■■
file1.cpp	func1	40% ■■■■
file3.cpp	func2	30% ■■■
file2.cpp	func1	20% ■■
file1.cpp	func2	10% ■
file3.cpp	func3	10% ■
file3.cpp	func1	0%

(3) Clicking on the C0 Coverage and File columns, in that order

The data for each file is sorted by coverage rate in descending order.

Example:

File	Function	C0 Coverage
file1.cpp	func3	80% ■■■■■■■■
file1.cpp	func4	70% ■■■■■■■■
file1.cpp	func1	40% ■■■■
file1.cpp	func2	10% ■
file2.cpp	func3	90% ■■■■■■■■
file2.cpp	func2	60% ■■■■■■
file2.cpp	func1	20% ■■
file3.cpp	func2	30% ■■■
file3.cpp	func3	10% ■
file3.cpp	func1	0%

5.11.8 Searching for Nonexecuted Lines

Search for nonexecuted lines in a selected address range or function. When you click on the Find toolbar button , the Find dialog box shown below appears.

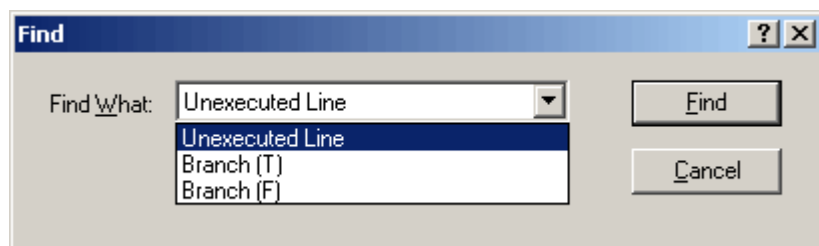



Figure 5.79 Find dialog box

The following three search options are available.

Table 5.33 Search options

Unexecuted Line	Instructions not executed yet
Branch (T)	Branch instructions with condition that is always TRUE when tested
Branch (F)	Branch instructions with condition that is always FALSE when tested

Clicking on the Find Next button  starts a search.

When a matching instruction is found, the corresponding line is highlighted.

When no matching instructions are found, a message is displayed.

5.11.9 Clearing Code Coverage Information

(1) Clearing the code coverage information for a specified range

Selecting Clear Coverage Range from the popup menu opens the Clear Address Range dialog box.

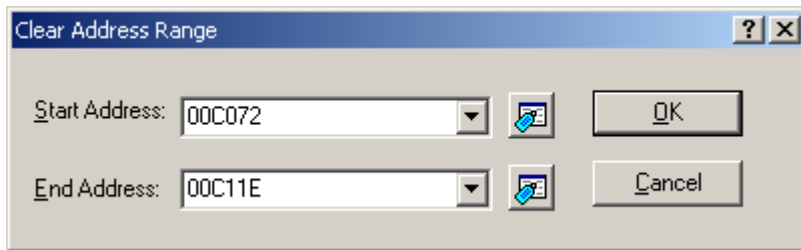

Figure 5.80 Clear Address Range dialog box

Enter the addresses where the range to be cleared starts and ends. Clicking on the OK button then clears the coverage information for the selected range.

(2) Clearing all of the code coverage information

Selecting Clear the Entire Coverage from the popup menu clears all of the code coverage information.

5.11.10 Updating Coverage Information

Selecting Refresh from the popup menu updates the contents of the Code Coverage window.

If Lock Refresh has been selected, the information is not automatically updated when program execution breaks. To view the latest information, therefore, you must manually select updating.

5.11.11 Preventing Updates to Coverage Information

Selecting Lock Refresh from the popup menu prevents updates to the Code Coverage window while the execution of the user program is stopped.

5.11.12 Saving the Code Coverage Information in a File

You can save the code coverage information for the currently selected sheet in a file. Selecting Save Data from the popup menu opens the Save Coverage Data dialog box.

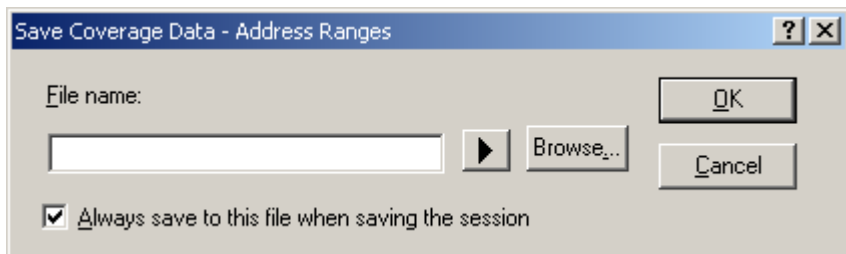

Figure 5.81 Save Coverage Data dialog box

Enter the name of the file where you want the information to be saved. If the file-name extension is omitted, “.cov” will automatically be appended as the extension. If you specify an existing file name, that file will be overwritten.

5.11.13 Loading Code Coverage Information from a File

You can load code-coverage information files. Selecting Load Data from the popup menu opens the Load Coverage Data dialog box.

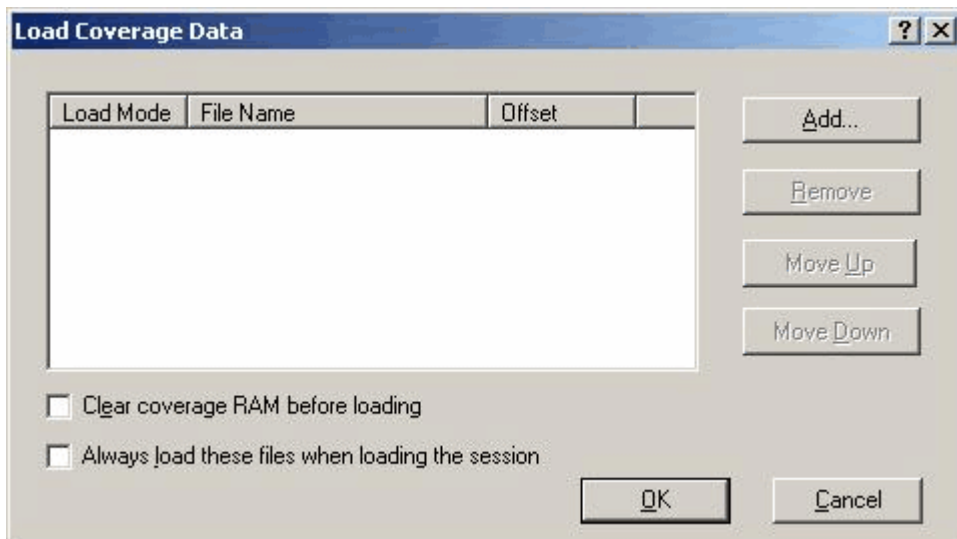

Figure 5.82 Load Coverage Data dialog box

Clicking on the Add button opens the Add Coverage Files dialog box shown below.

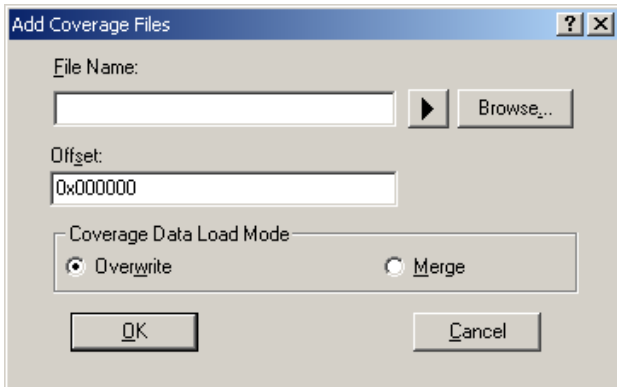

Figure 5.83 Add Coverage Files dialog box

Use this dialog box to specify the coverage information file you want to load. You can also specify a mode of loading and offset for each file you load.

The only file-name extension allowed is “.cov”. An error message will appear if any other extension is entered.

The files you add will be listed in the Load Coverage Data dialog box. The files will be loaded in the order in which they are listed. If necessary, use the Move Up or Move Down button to change the order.

CAUTION

If the coverage information file you’re loading is of the source-file type, you cannot specify an offset.

5.11.14 Modes of Loading for Coverage Information Files

Two modes of loading are available for coverage information files. They are schematically depicted below.

(1) When “Overwrite” has been selected

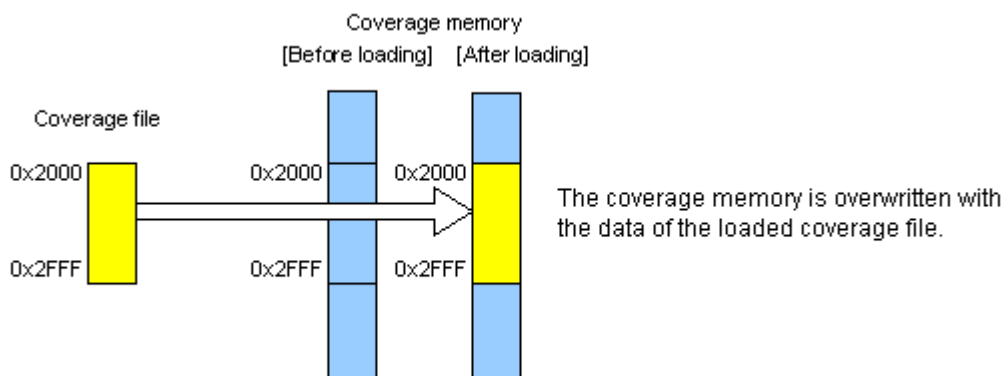

Figure 5.84 Schematic view of the overwrite mode

(2) When “Merge” has been selected

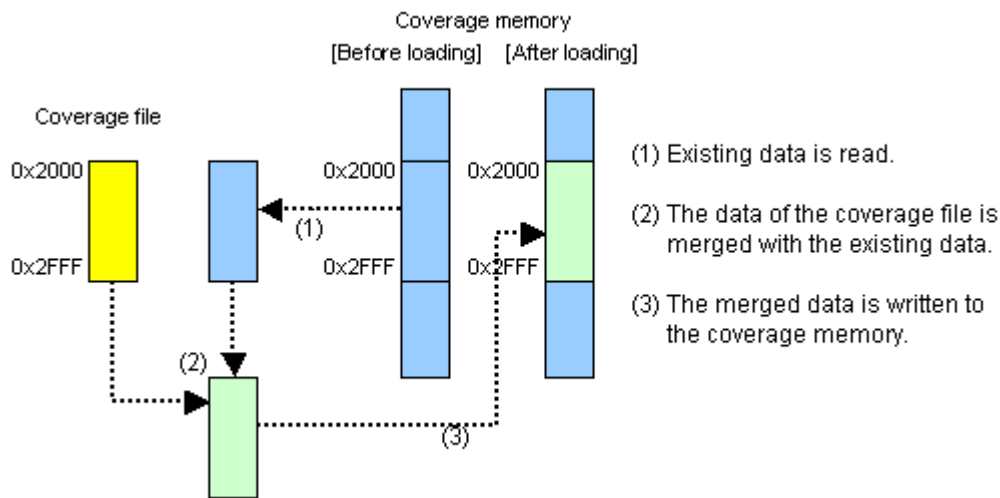

Figure 5.85 Schematic of the merge mode

(3) Example of application of the merge mode

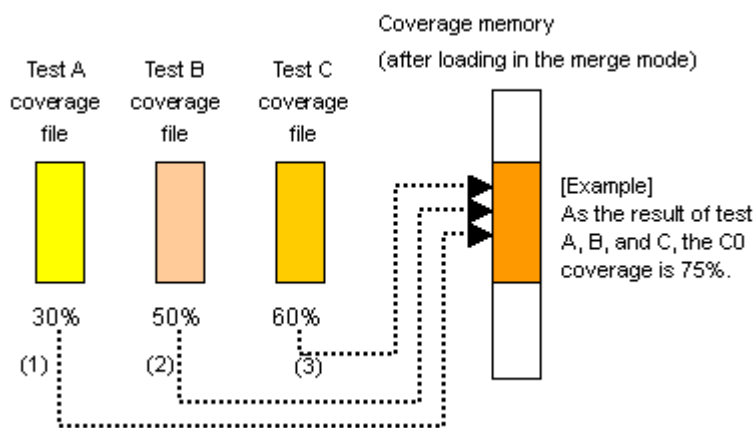

Figure 5.86 Schematic view of a merge-mode application

[Procedure]

(1) Open the Load Coverage Data dialog box.

To begin with, select the “Clear coverage RAM before loading” checkbox.

(2) In the merge mode, add the coverage file for test A.

(3) In the merge mode, add the coverage file for test B.

(4) In the merge mode, add the coverage file for test C.

(5) Click on the OK button.

You have now finished merging three files.

By re-calculating the percentages in the Code Coverage window, you can view the coverage (as percentages) of the tests as a whole.

Furthermore, you can save the merged data in a single file and manage the data accordingly.

5.11.15 Displaying Code Coverage Information in the Editor Window

When the Editor window is open in the source mode, the results of coverage are displayed in the Code Coverage column.

Rows of the Code Coverage column that correspond to source lines where the instructions have been executed are highlighted.

If the user changes any setting related to coverage information in the Code Coverage window, the contents of the corresponding Code Coverage column will also be updated.

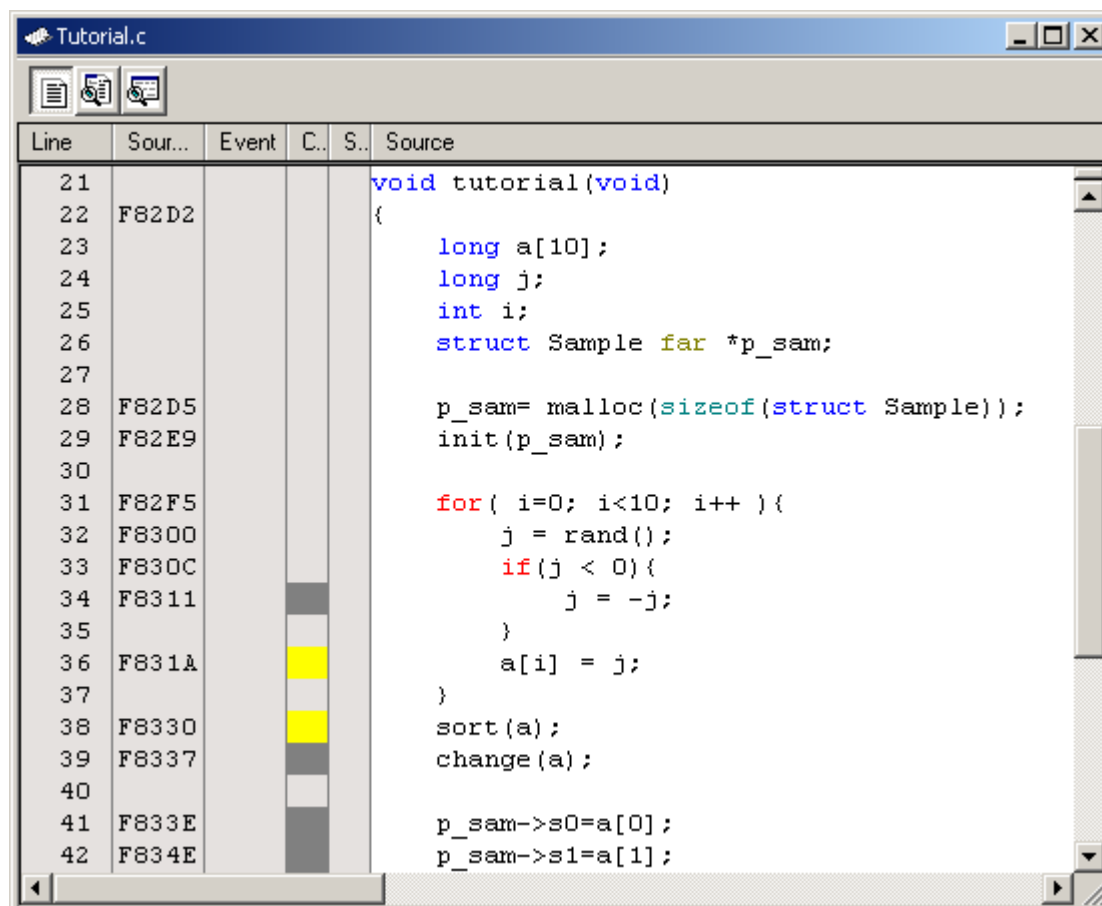

Figure 5.87 Example of code coverage results

5.12 Measuring Data Coverage

5.12.1 Measuring Data Coverage

The code coverage, data coverage and realtime profiling functions of the E100 emulator are mutually exclusive.

To use the data coverage function, choose Data coverage in the Switching function section on the System page of the Configuration properties dialog box.

Data coverage indicates the kinds of access to data areas. The emulator is capable of acquiring information on access per byte without causing program execution to break. Therefore, the realtime characteristic of user-program execution will not be affected.

The coverage results are updated upon a break.

The E100 emulator comes with 512 Kbytes of data coverage memory.

With the initial settings, the data coverage memory is automatically allocated to addresses in the ROM and Data Flash areas.

5.12.2 Opening the Data Coverage Window

Choose Code -> Data Coverage from the View menu or click on the Data Coverage toolbar button .

The Data Coverage window is initially empty.

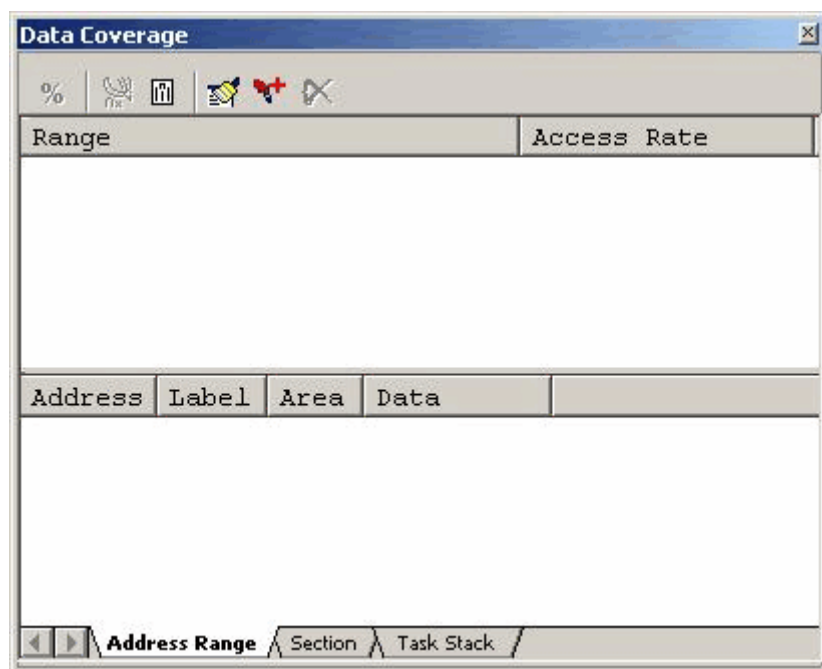

Figure 5.88 Data Coverage window

(1) Measurement method

The Data Coverage window has three sheets.

Table 5.34 Sheets of the Data Coverage window

Sheet	Description
Address Range	Measurement is performed on any address range.
Section	Measurement is performed on a specified section.
Task Stack	Measurement is performed for all task stack areas.

The respective sheets permit multiple ranges to be registered.

The Task Stack sheet only supports automatic registration.

Up to three instances of the Data Coverage window can be opened at the same time.

5.12.3 Allocating Data Coverage Memory (Hardware Resource)

(1) Memory allocation

Before data coverage can be measured, data-coverage memory must be assigned to the target address range. Coverage data can only be obtained from an address range to which memory has been allocated.

To allocate data coverage memory, use the Allocation of Data Coverage Memory dialog box. To open this dialog box, select [Hardware Settings...] from the popup menu of the Data Coverage window.

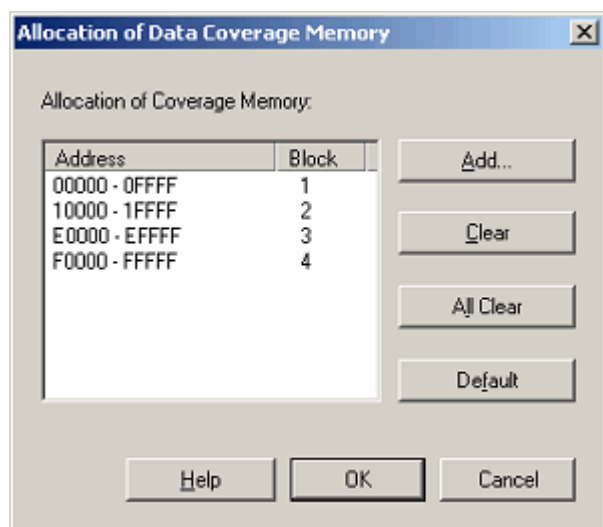

Figure 5.89 Allocation of Data Coverage Memory dialog box

You can specify any number of blocks from 1 to 8 (for a total of up to 512 Kbytes), each beginning on a 64-Kbyte boundary, as areas for data-coverage measurement.

The blocks may be contiguous or non-contiguous.

With the initial settings, the coverage memory is automatically allocated to addresses in the RAM and Data Flash areas.

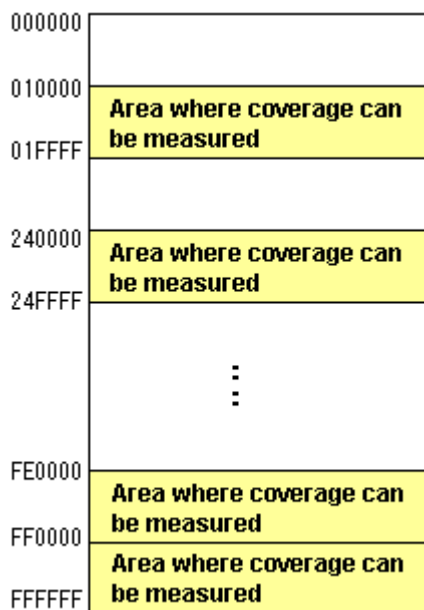

Figure 5.90 Schematic view of data coverage memory allocation

(2) Changing memory allocation

When the allocation of coverage memory is changed, the coverage data acquired from the target address ranges prior to the change is retrieved from coverage memory into a dedicated coverage buffer.

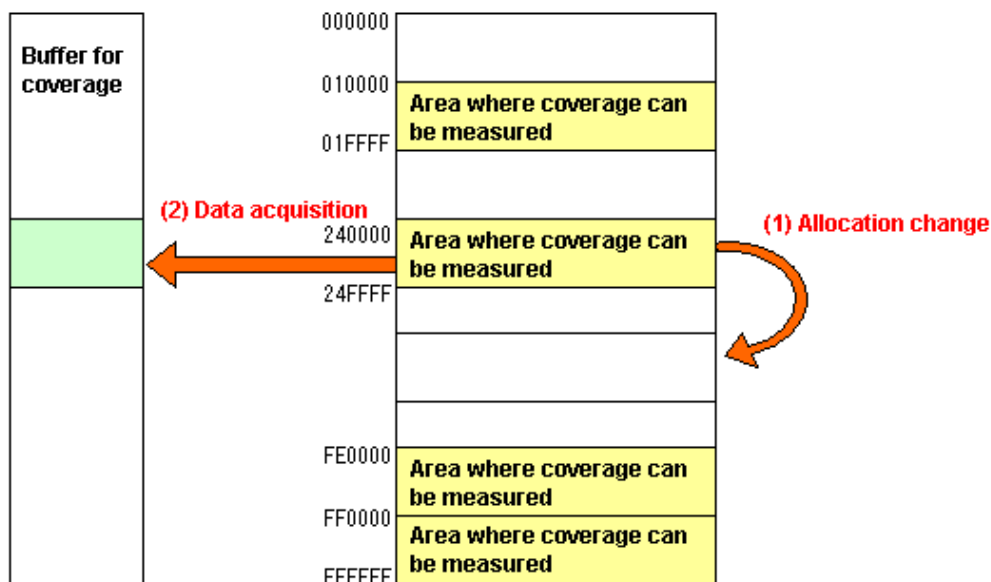

Figure 5.91 Schematic view of a change in data coverage memory allocation

Acquired coverage information is accumulated in the coverage buffer until it is cleared by the user. However, coverage information is not updated for areas to which coverage memory is not allocated.

The coverage information shown in the Data Coverage window includes the information from the contents of the coverage buffer.

5.12.4 Data Coverage in an Address Range

The E100 emulator is capable of collecting the access information for a user-specified address range and of displaying the information.

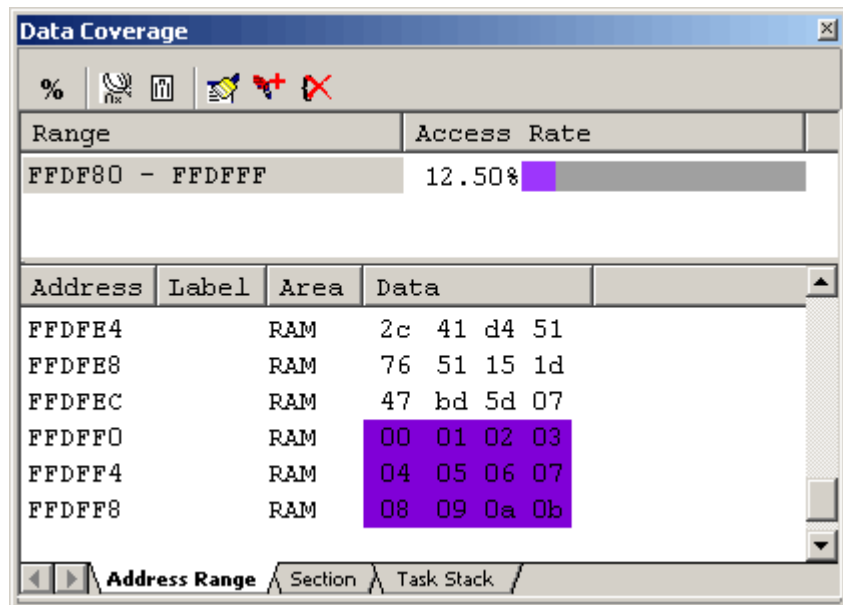

Figure 5.92 Data Coverage window (address specification)

The Data Coverage window is vertically divided in two by the splitter. The upper pane shows the address ranges to be measured and access rates.

Table 5.35 Contents of the upper pane of the Data Coverage window

[Range]	Address range for which coverage is measured
[Access Rate]	Access rate as a percentage and graph

The lower pane shows a detailed view of the address range selected in the upper pane.

Table 5.36 Contents shown in the lower pane of the Data Coverage window

[Address]	Address value
[Label]	Label name
[Area]	Memory area (RAM, Data Flash, IO, or Flash ROM). This column is blank when the area is unused.
[Data]	Memory data. Data that have been accessed are displayed against a purple background.

Lines for addresses beyond the area to which coverage memory has been allocated are grayed-out. Although any existing coverage information for such addresses is retained, the coverage information will not be updated by program execution. Acquired coverage information is accumulated in memory until it is cleared by the user.

5.12.5 Data Coverage in Sections

The E100 emulator is capable of collecting the access information for a user-specified section and of displaying the information.

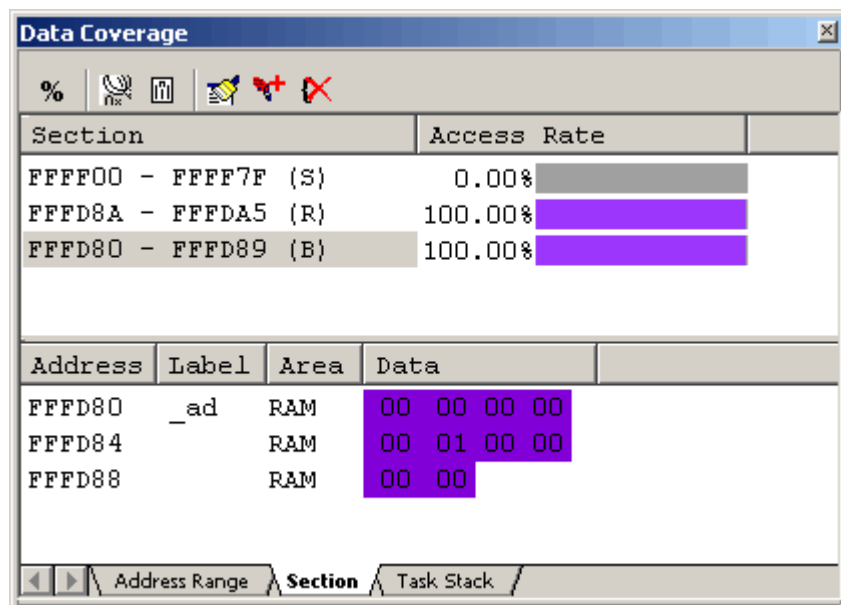

Figure 5.93 Data Coverage window (section name specification)

The Data Coverage window is vertically divided in two by the splitter.

The upper pane shows the address ranges (section names) to be measured and access rates.

Table 5.37 Contents of the upper pane of the Data Coverage window

[Section]	Address range (section) for which coverage is measured
[Access Rate]	Access rate as a percentage and graph

The lower pane shows a detailed view of the address range selected in the upper pane.

Table 5.38 Contents of the lower pane of the Data Coverage window

[Address]	Address value
[Label]	Label name
[Area]	Memory area (RAM, Data Flash, IO, or Flash ROM). This column is blank when the area is unused.
[Data]	Memory data. Data that have been accessed are displayed against a purple background.

Lines for addresses beyond the area to which coverage memory has been allocated are grayed-out. Although any existing coverage information for such addresses is retained, the coverage information will not be updated by program execution.

Acquired coverage information is accumulated in memory until it is cleared by the user.

5.12.6 Data Coverage in the Task Stack

The E100 emulator is capable of collecting the access information for the task stacks and of displaying the information. The task stack is automatically registered when a load module that includes an OS has been downloaded. You cannot add, remove or change any task. If tasks are changed pursuant to alterations of the user program, for example, the window is automatically updated.

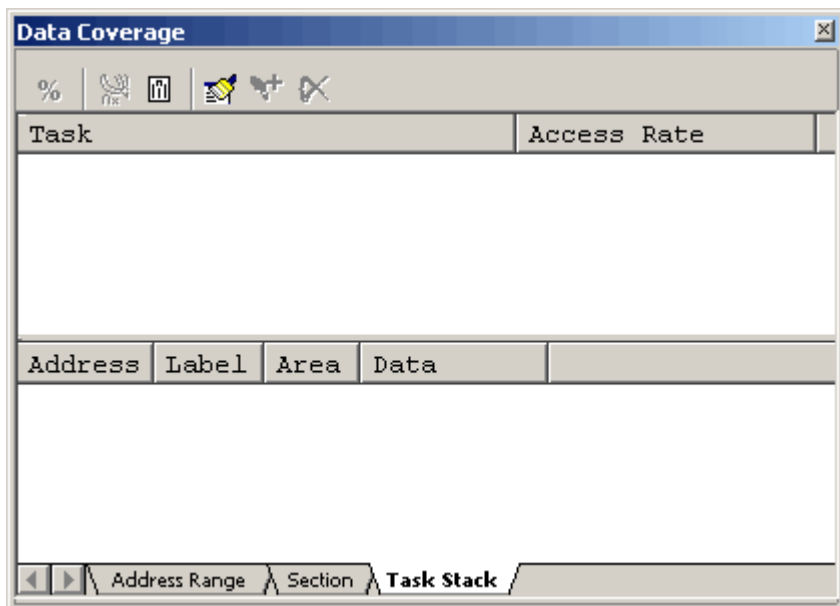

Figure 5.94 Data Coverage window (task stack specification)

The Data Coverage window is vertically divided in two by the splitter. The upper pane shows the automatically registered task stacks and access rates.

Table 5.39 Contents of the upper pane of the Data Coverage window

[Task]	Task stack (task ID and task entry label)
[Access Rate]	Access rate as a percentage and graph

The lower pane shows a detailed view of the task stack selected in the upper pane.

Table 5.40 Contents of the lower pane of the Data Coverage window

[Address]	Address value
[Label]	Label name
[Area]	Memory area (RAM, Data Flash, IO, or Flash ROM). This column is blank when the area is unused.
[Data]	Memory data. Data that have been accessed are displayed against a purple background.

Lines for addresses beyond the area to which coverage memory has been allocated are grayed-out. Although any existing coverage information for such addresses is retained, the coverage information will not be updated by program execution. Acquired coverage information is accumulated in memory until it is cleared by the user.

5.12.7 Clearing Data Coverage Information

(1) Clearing the data coverage information for a specified range

Selecting Clear Coverage Range from the popup menu on the Address Range or Section sheet opens the Clear Coverage Range dialog box.

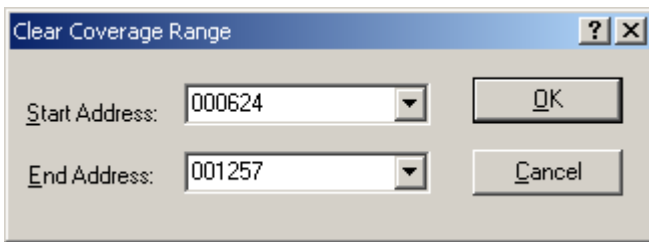

Figure 5.95 Clear Coverage Range dialog box

Enter the addresses where the range to be cleared starts and ends. Clicking on the OK button then clears the coverage information for the selected range.

(2) Clearing all of the data coverage information

Selecting Clear the Entire Coverage from the popup menu clears all of the data coverage information.

5.12.8 Updating Coverage Information

Selecting Refresh from the popup menu updates the content of the Data Coverage window.

If Lock Refresh has been selected, the information is not automatically updated when program execution breaks. To view the latest information, therefore, you must manually select updating.

5.12.9 Preventing Updates to Coverage Information

Selecting Lock Refresh from the popup menu prevents updates to the Data Coverage window while the execution of the user program is stopped.

5.12.10 Saving the Data Coverage Information in a File

You can save the data coverage information for the currently selected sheet in a file. Selecting Save Data from the popup menu opens the Save Data dialog box.

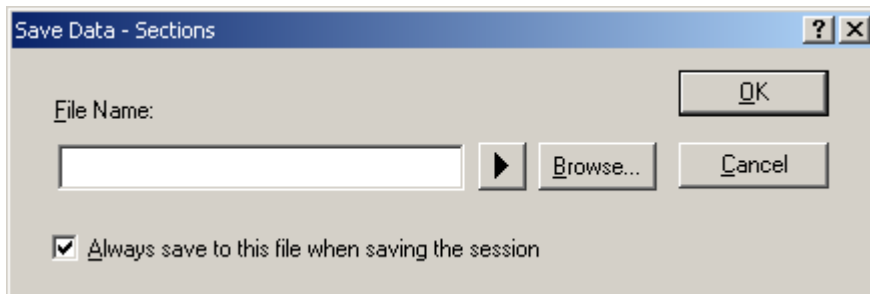

Figure 5.96 Save Data dialog box

Enter the name of the file where you want the information to be saved. If the file-name extension is omitted, “.cdv” will automatically be appended as the extension. If you specify an existing file name, that file is overwritten.

5.12.11 Loading Data Coverage Information from a File

You can load data-coverage information files.

Selecting Load Data from the popup menu opens the Load Coverage Data dialog box.

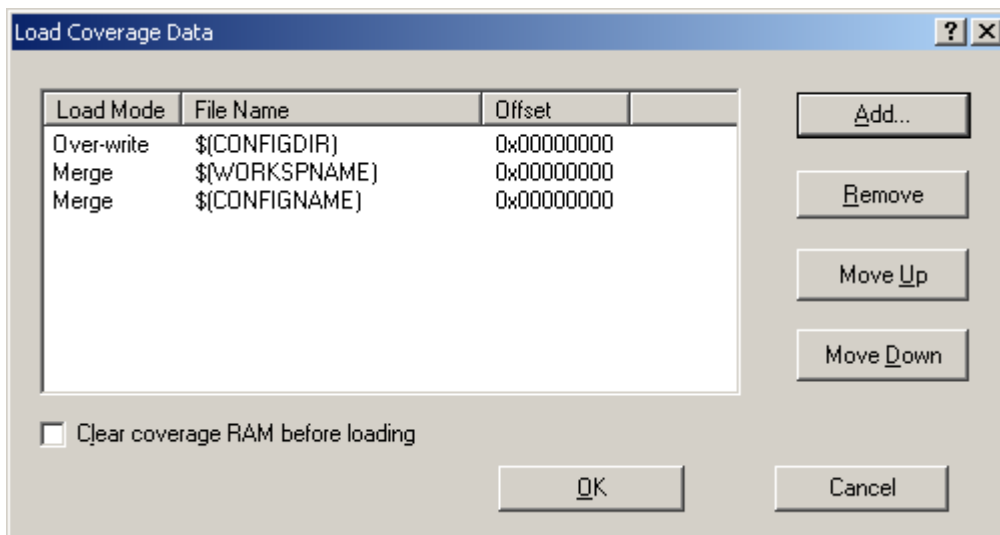

Figure 5.97 Load Coverage Data dialog box

Clicking on the Add button opens the Add coverage data file dialog box shown below.

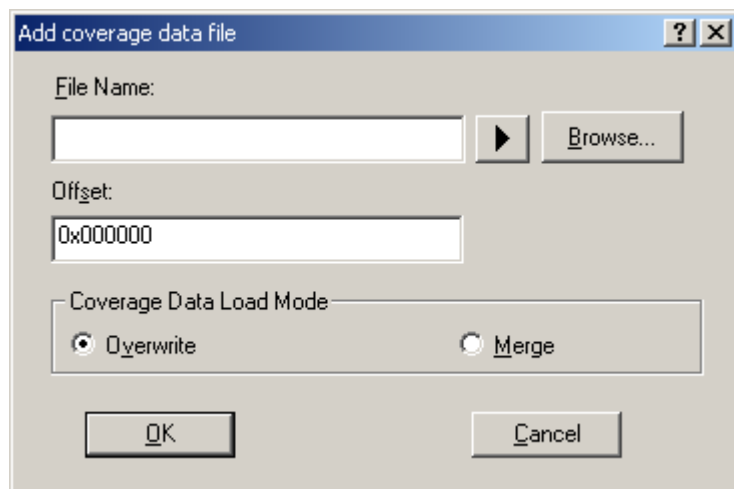

Figure 5.98 Add coverage data file dialog box

Use this dialog box to specify the coverage information file you want to load. You can also specify a mode of loading and offset for each file you load.

The only file-name extension allowed is ".cdv". An error message will appear if any other extension is entered.

The files you add will be listed in the Load Coverage Data dialog box. The files will be loaded in the order in which they are listed. If necessary, use the Move Up or Move Down button to change the order.

5.13 Viewing Realtime Profile Information

5.13.1 Viewing Realtime Profile Information

The code coverage, data coverage and realtime profiling functions of the E100 emulator are mutually exclusive.

To use the realtime profiling function, choose Real-time profile in the Switching function section on the System page of the Configuration properties dialog box.

Realtime profiling refers to the measurement of performance per function or task within an area allocated as a range for profiling. Realtime profiling will help you find where and how deterioration in the performance of application programs arises.

The process of measurement does not interfere with execution of the user program.

The results of measurement are updated when execution of the program breaks.

(1) Function profiles

Performance of individual functions can be measured.

For a function, the Realtime Profile window shows its name, the address where it starts, its size, the number of calls, cumulative execution time, the ratio of this to the overall execution time, and the average execution time.

In function profiling by the E100 emulator, execution times for subroutines are not included in the indicated cumulative execution time.

CAUTION

A function profile is subject to the following limitations:

(a) Areas to be measured

The E100 emulator can acquire profile information on all functions in up to 8 blocks, with each block a 128-Kbyte unit.

The blocks can be contiguous or non-contiguous.

Functions located beyond the boundaries of the blocks are not specifiable. In such cases, the entries for the functions (or tasks) are grayed-out.

(b) Limit on the number of functions

Measurement of up to $8K - 1$ (= 8,191) functions is possible.

A limit of $8K - 1$ (= 8,191) applies to the number of functions within the above scope of measurement. Measurement will not be performed for the functions beyond this limit. In such cases, the names, addresses, and sizes of the excess functions are grayed-out.

(c) In-line expansion

The functions that have been written for in-line expansion (optimization by the compiler) are not displayed in the Realtime Profile window.

(d) Recursive functions

Although the execution times of recursive functions can be measured correctly, they are only executed once.

(e) Relationship between the address where Go was executed and the address of a break within a measurement range, and the measurable range

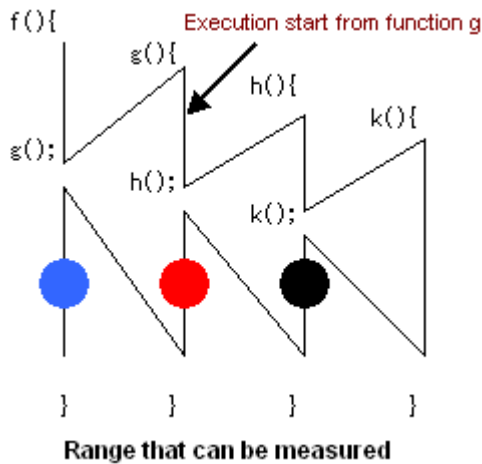

Figure 5.99 Measurable range

The measurable range will be as follows.

When execution of the program breaks at the location of a black dot [●]: Execution time and number of passes for functions `h` and `k`

When execution of the program breaks at the location of a red dot [●]: Execution time and number of passes for functions `h` and `k`

When execution of the program breaks at the location of a blue dot [●]: Execution time and number of passes for functions `h` and `k`

For the function `g`, the number of passes and time for the executed portion can be measured.

Even after execution has returned to a function higher in the hierarchy of calls, the number of calls cannot be measured for a function from which execution of the program started.

(f) Function measurement

Accurate measurement requires that execution of the function remained in progress for at least 100 ns. If this is not the case, the execution time and number of passes may be incorrect.

(g) Debugging information option

To get the execution time and number of passes for a function, you need to specify the option to output debugging information for the source file or library that includes the function at the time of compilation. If this option has not been specified, measurement of the execution time and number of passes for a function will not be possible.

(h) Maximum and minimum execution time

You cannot use the realtime profiling function to measure the maximum and minimum execution times for a function. To measure the maximum and minimum execution times for a function, use the Performance Analysis window.

(2) Task profile

Performance of individual tasks can be measured.

For a task, the Realtime Profile window shows its ID, the number of passes, cumulative execution time, the ratio of this to the overall execution time, and the average execution time.

5.13.2 Selecting a Realtime Profile Measurement Mode

Choose Set Range from the popup menu that is displayed when you right-click in the window.

The Realtime Profile Setting dialog box will be displayed. In the Realtime Profile Mode list box of this dialog box, you can select "Function Profile" or "Task Profile."

When the profile mode is changed, all results of measurement are cleared.

5.13.3 Measuring Function Profiles

The Function Profile mode allows measurement of performance per function.

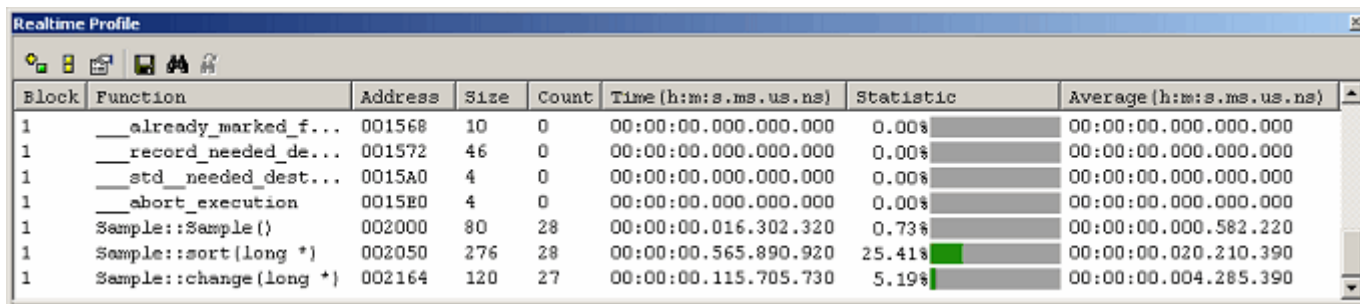

Figure 5.100 Realtime Profile window (function profile)

The information in each of the columns is described in the table below.

Table 5.41 Details on each column

Block	Block number
Function	Function name
Address	Address where the function starts
Size	Function size
Count	Number of times the function has been called
Time (h:m:s.ms.us.ns)	Cumulative time of function execution The timestamp is in the form shown below. Hours:minutes:seconds.milliseconds.microseconds.nanoseconds
Statistic	Ratio of the time for the given function to Go-Break time
Average (h:m:s.ms.us.ns)	Average of the execution times for individual passes

If a function is outside the areas to which profile memory is allocated, the address line is grayed-out. Acquired results of profile measurement are accumulated in memory until the user clears them.

5.13.4 Setting Ranges for Function Profile Measurement

Choose Set Range from the popup menu that is displayed when you right-click in the window.

The Realtime Profile Setting dialog box will be displayed. Set a profile measurement range in this dialog box.

[Function profile mode]

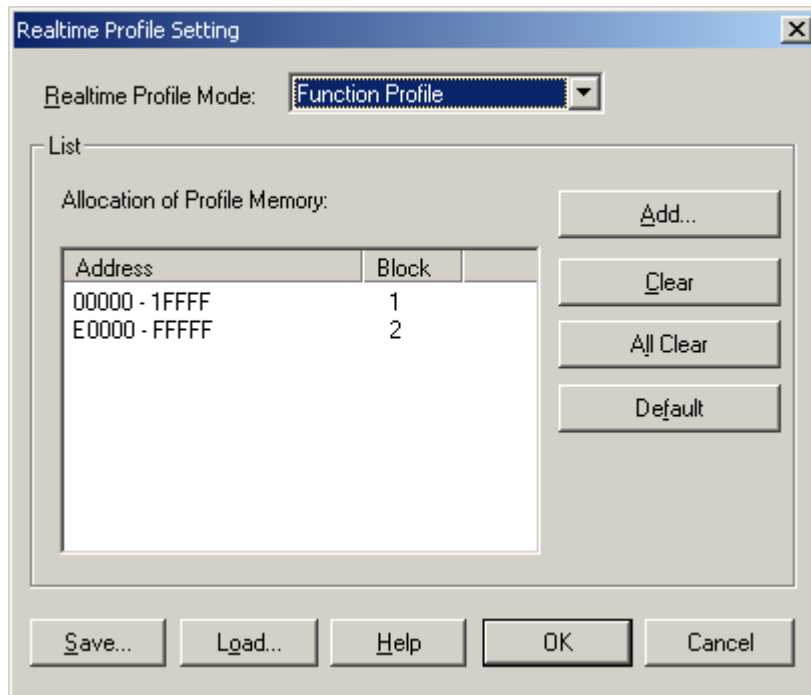

Figure 5.101 Realtime Profile Setting dialog box

(1) Memory allocation

Before function profiles can be measured, profile memory must be allocated to the addresses at which measurement will be performed. Profile data can only be obtained from address ranges to which memory has been allocated.

You can specify any number of blocks 1 to 8 (for a total of up to 1 Mbyte), each beginning on a 128-Kbyte boundary, as areas for profile measurement.

The blocks may be contiguous or non-contiguous.

With the initial settings, the profile memory is automatically allocated to addresses in the ROM areas.

(2) Automatic detection of functions

When profile memory is assigned to an address range, the E100 emulator automatically detects functions within that range and adds them to the window.

5.13.5 Saving Function Profile Measurement Settings

You can save the current profile mode and measurement ranges (memory allocation) for function profiles.

Click on the Save button of the Realtime Profile Setting dialog box, and the Save As dialog box will be displayed.

Enter the name of the file where you want the function profile measurement settings to be saved.

If the file-name extension is omitted, “.rpf” will automatically be appended as the extension.

If you specify an existing file name, a message is displayed asking you to confirm whether you want the file to be overwritten.

5.13.6 Loading Function Profile Measurement Settings

You can load function profile measurement settings.

Click on the Load button of the Realtime Profile Setting dialog box, and the Open dialog box will be displayed.

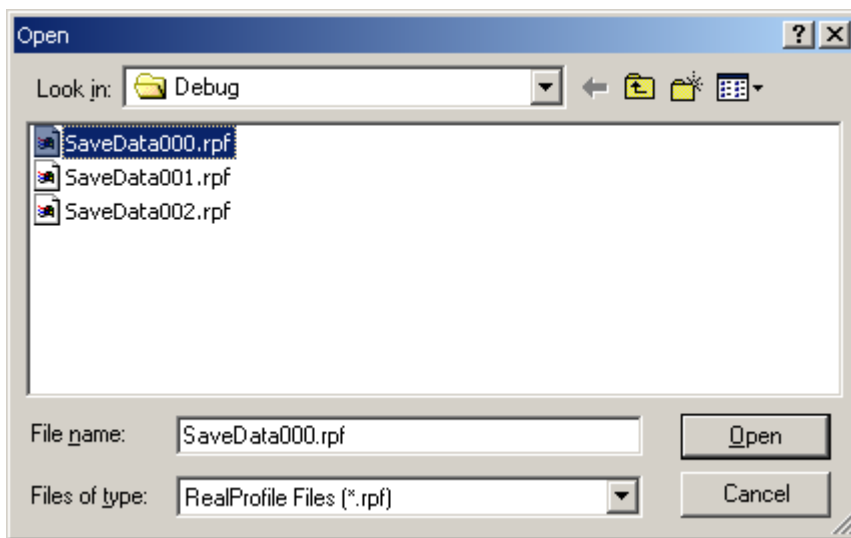

Figure 5.102 Open dialog box

Enter the name of the file you want to load.

Only files bearing the extension “.rpf” can be loaded. If you enter any other file-name extension, an error message will be output.

When loading of the file is complete, the list in the Realtime Profile Setting dialog box is updated.

If the information in the loaded file is for a task profile, the profile mode in the Realtime Profile Setting dialog box is switched to task mode.

5.13.7 Measuring Task Profiles

The Task Profile mode allows measurement of performance per task.

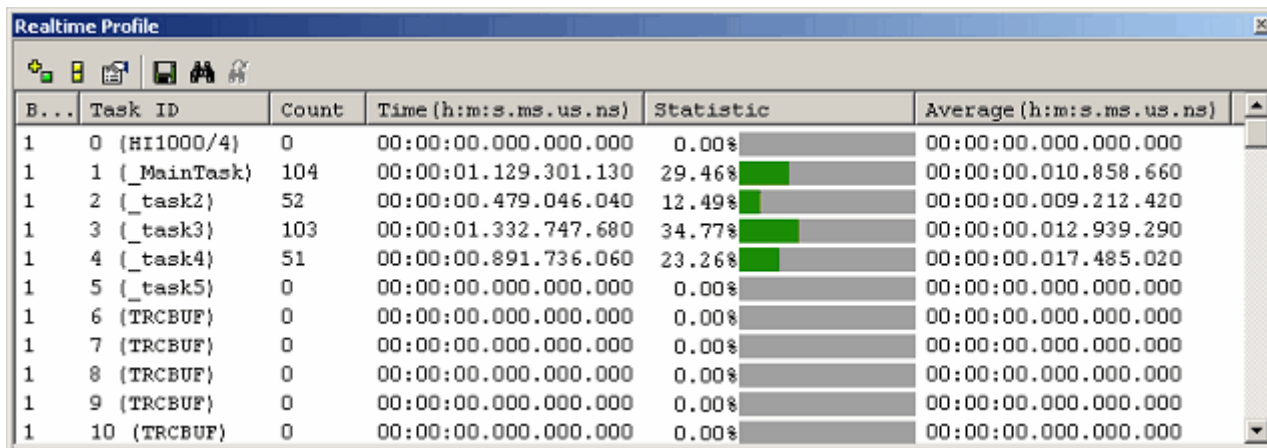

Figure 5.103 Realtime Profile window (task profile)

The information in each of the columns is described in the table below.

Table 5.42 Details on each column

Block	Block number
Task ID	Task ID, entry address
Count	Number of times the task has been called
Time (h:m:s.ms.us.ns)	Cumulative time of task execution The timestamp is in the form shown below. Hours:minutes:seconds.milliseconds.microseconds.nanoseconds
Statistic	Ratio of the time for the given function to Go-Break time
Average (h:m:s.ms.us.ns)	Average of the execution times for individual passes

Disabled tasks are grayed-out.

Acquired results of profile measurement are accumulated in memory until the user clears them.

5.13.8 Setting Ranges for Task Profile Measurement

Choose Set Range from the popup menu that is displayed when you right-click in the window.

The Realtime Profile Setting dialog box will be displayed. Set a profile measurement range in this dialog box.

[Task profile mode]

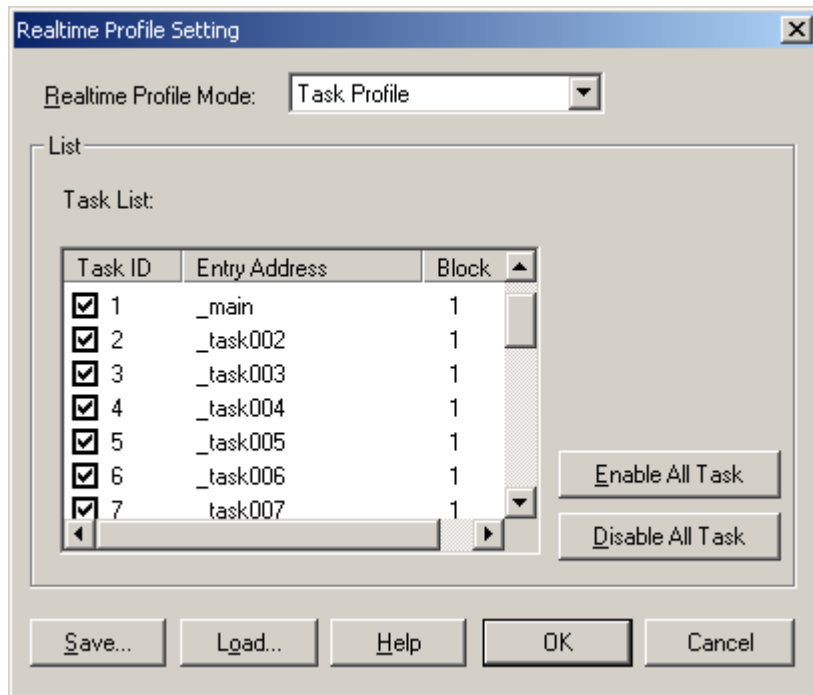

Figure 5.104 Realtime Profile Setting dialog box

(1) Automatic detection of tasks

If you have downloaded a load module that includes an OS, the E100 emulator automatically detects the tasks.

(2) Selecting tasks

Select the checkboxes next to the IDs of tasks you want to measure (by default, all checkboxes are selected).

The selected tasks will automatically be assigned block numbers (1–8).

CAUTION

When the eight blocks have been used up, the block number column for further tasks will be blank, indicating that measurement for tasks with these IDs is not possible. In such cases, deselect checkboxes against the IDs of tasks for which performance measurement is not necessary.

5.13.9 Saving Task Profile Measurement Settings

You can save the current settings regarding tasks for measurement (task IDs and enabled/disabled states) in task mode.

Click on the Save button of the Realtime Profile Setting dialog box, and the Save As dialog box will be displayed.

Enter the name of the file where you want the task profile measurement settings to be saved.

If the file-name extension is omitted, “.rpf” will automatically be appended as the extension.

If you specify an existing file name, a message is displayed asking you to confirm whether you want the file to be overwritten.

5.13.10 Loading Task Profile Measurement Settings

You can load task profile measurement settings.

Click on the Load button of the Realtime Profile Setting dialog box, and the Open dialog box will be displayed.

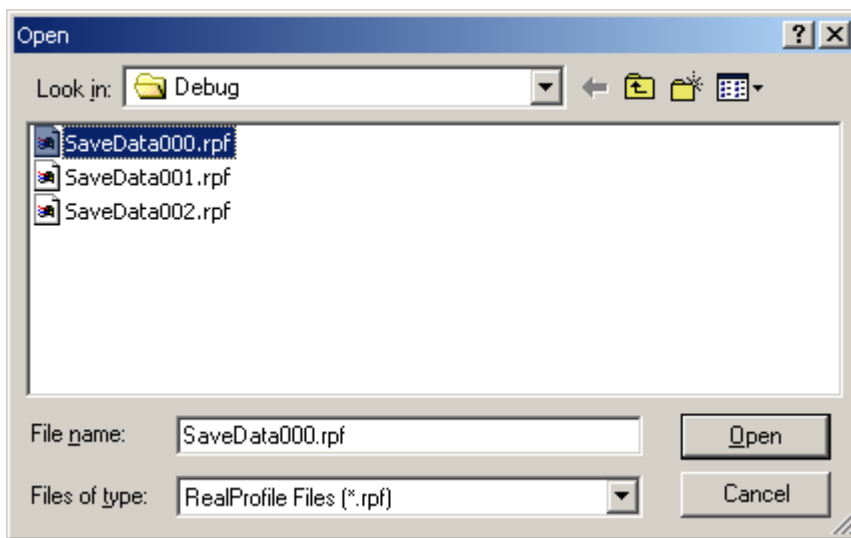

Figure 5.105 Open dialog box

Enter the name of the file you want to load.

Only files bearing the extension “.rpf” can be loaded. If you enter any other file-name extension, an error message will be output.

When loading of the file is complete, the list (of tasks) in the Realtime Profile Setting dialog box is updated.

Even if a loaded task ID does not currently exist, it will be temporarily displayed in the list of tasks in the Realtime Profile Setting dialog box. However, only tasks with the existing IDs will actually be registered when you click on the OK button.

You can re-open the Realtime Profile Setting dialog box to check the currently registered tasks.

If the information in the loaded file is for a function profile, the profile mode in the Realtime Profile Setting dialog box is switched to function mode.

5.13.11 Clearing Results of Realtime Profile Measurement

Choose Clear from the popup menu of the Realtime Profile window, and all results of measurement are cleared. Unless this is done, measurement results are accumulated in memory.

5.13.12 Saving Results of Realtime Profile Measurement

You can save the current results of realtime profile measurement as text.

Choose Save To File from the popup menu of the Realtime Profile window, and the Save As dialog box will be displayed.

Enter the name of the file where you want the results of measurement to be saved.

If the file-name extension is omitted, “.txt” will automatically be appended as the extension.

If you specify an existing file name, a message is displayed asking you to confirm whether you want the file to be overwritten.

5.13.13 Setting the Unit of Measurement

Choose Properties from the popup menu that is displayed when you right-click in the window.

The Properties dialog box will be displayed.

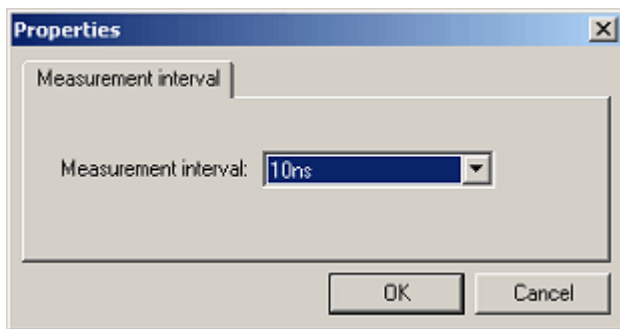

Figure 5.106 Properties dialog box

The unit of measurement can be selected from the following options:

10 ns (default), 20 ns, 40 ns, 80 ns, 160 ns, 1.6 μ s

CAUTION

When the current selection is changed, the measurement results hitherto accumulated are cleared.

5.13.14 Maximum Measurement Time for Realtime Profiles

(1) Maximum measurement time

The timer used for realtime profile measurement is configured with a 40-bit counter. The maximum measurement time varies with the selected unit of measurement.

Select the unit of measurement from the Measurement interval drop-down list of the Properties dialog box.

The maximum measurable times for the respective units are listed below.

Table 5.43 Maximum measurable times

Resolution	Maximum measurement time
10 ns	Approx. 3 hours, 03 minutes, 15 seconds
20 ns	Approx. 6 hours, 06 minutes, 30 seconds
40 ns	Approx. 12 hours, 13 minutes, 00 seconds
80 ns	Approx. 24 hours, 26 minutes, 00 seconds
160 ns	Approx. 48 hours, 52 minutes, 01 seconds
1.6 μ s	Approx. 488 hours, 40 minutes, 18 seconds

CAUTION

Note that results of performance measurement carry an error equal to $\pm(\text{twice the resolution} + 100\text{ns})$, e.g. ± 140 ns when the resolution is 20 ns, each time a function is entered. If the resolution is 20 ns and a function is entered 10 times, the error is ± 1400 ns.

(2) Maximum measured number of calls

For a realtime profile, a 16-bit counter measures the number of times a task or function is executed. Measurement of up to 65,535 calls is thus possible.

5.14 Detecting Exceptional Events

5.14.1 Detecting Exceptional Events

The E100 emulator permits you to detect the occurrence of various exceptional events during user program execution. Exceptional events include abnormal behavior of the user program, as well as an overflow of the measurement counter for break, trace, or performance analysis. Detection of a specific exceptional event can be set as a condition of a breakpoint or trace point.

(1) Exceptional events

The E100 emulator detects the exceptional events listed below.

- Violation of access protection: An error is detected when access in violation of a specified access attribute is attempted.
- Reading from non-initialized memory: An error is detected when a non-initialized area (not written) is read.
- Stack access violation: An error is detected when the value of the stack register is beyond a boundary of the stack area.
- Performance-measurement overflow: An error is detected when the time measurement counter for a section has overflowed.
- Realtime profile overflow: An error is detected when the maximum measurable time or maximum measurable number of passes is exceeded during profile measurement of a function (or a task).
- Trace memory overflow: An error is detected when the trace memory has overflowed.
- Task stack access violation: An error is detected when one task attempts writing to the task stack of another task.
- OS dispatch: An error is detected if a task dispatch has occurred.

5.14.2 Detecting Violations of Access Protection

Violations of access protection such as writing to a ROM area or access to an unused area (for reading, writing, or execution of an instruction) can be detected as an error.

(1) Access attributes

The following attributes are specifiable in word units for any area.

Read/Write: Accessible for both reading and writing

Read Only: Only accessible for reading

Write Only: Only accessible for writing

Disable: Access prohibited

Disable (OS): Access other than from the OS is prohibited (this attribute is automatically assigned when a program that includes an OS is downloaded).

(2) Protected areas

Any area in the entire memory space can be protected.

At the time the emulator is booted up, all areas are assigned the Read/Write attribute by default.

(3) Methods of setting protection

There are the following two methods:

- Automatic setting by section information in a downloaded module
- Individually specifying an access attribute for an area

(4) Method of detection

Violation of access protection is detected by internal resources (blocks 1–16) of the emulator.
 The blocks are automatically allocated by an original algorithm of the emulator.

CAUTION

Since the emulator's internal resources are limited, not all blocks can be protected. If an error occurs, reduce the number of assigned blocks by using the 'Delete' button before setting protection again.

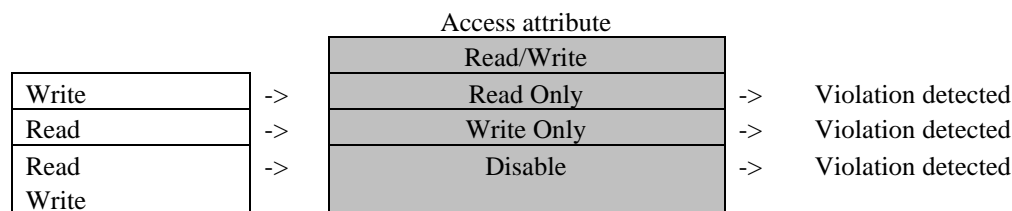

Figure 5.107 Patterns for detecting violation

(5) Action taken when violation of access protection is detected

The following actions are selectable.

- Display a warning.

After the Violation of access protection checkbox has been selected on the Exception Warning page of the Configuration properties dialog box, you will see a warning in the Status window and in a status bar balloon when errors of this type occur.

- Make the detection of violation of access protection a condition of a hardware breakpoint.
- Make the detection of violation of access protection a condition of a trace point.

5.14.3 Setting Protection for an Area

Follow the procedure below to set protection for an area.

(1) From the Hardware Break dialog box

1. Select the Exception checkbox on the Hardware Break sheet and then click on the Detail button.

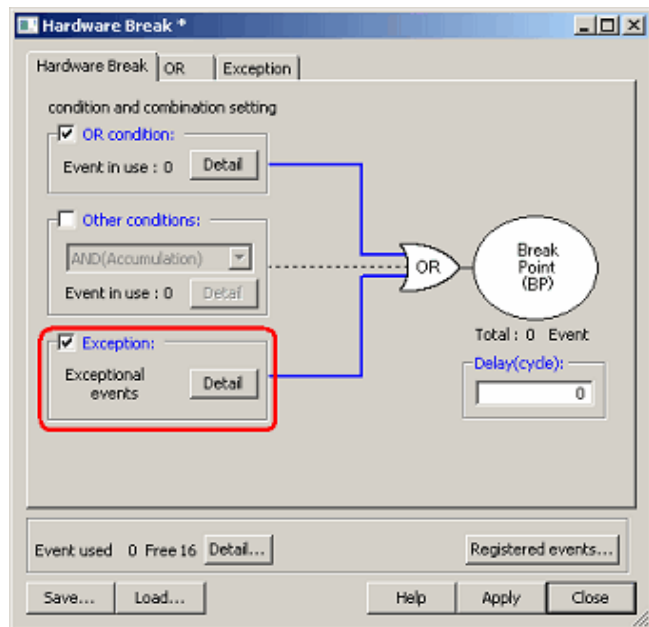

Figure 5.108 Hardware Break dialog box

2. The Exception page shown below will appear. Click the Detail button to the right of the Violation of access protection checkbox.

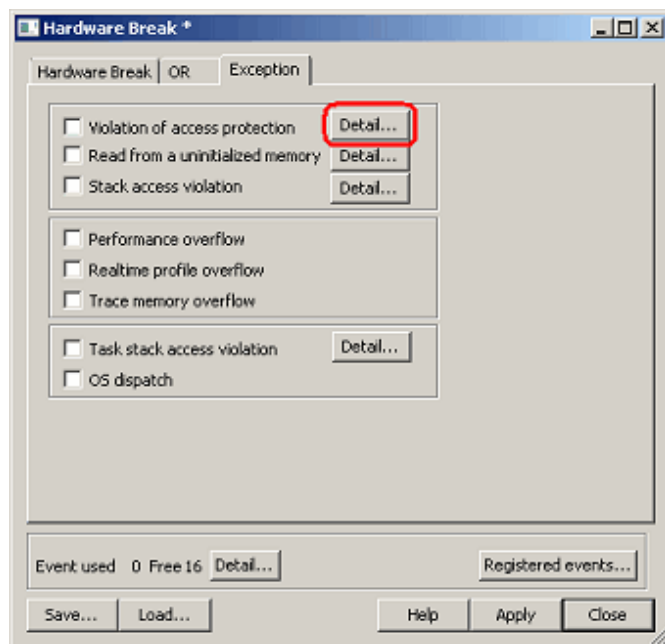

Figure 5.109 Hardware Break dialog box

3. The Violation of access protection dialog box shown below will be displayed.

To have the access attributes automatically set according to the section information in the downloaded module when a program is downloaded, select the checkbox labeled “Automatically set address areas at downloading.”

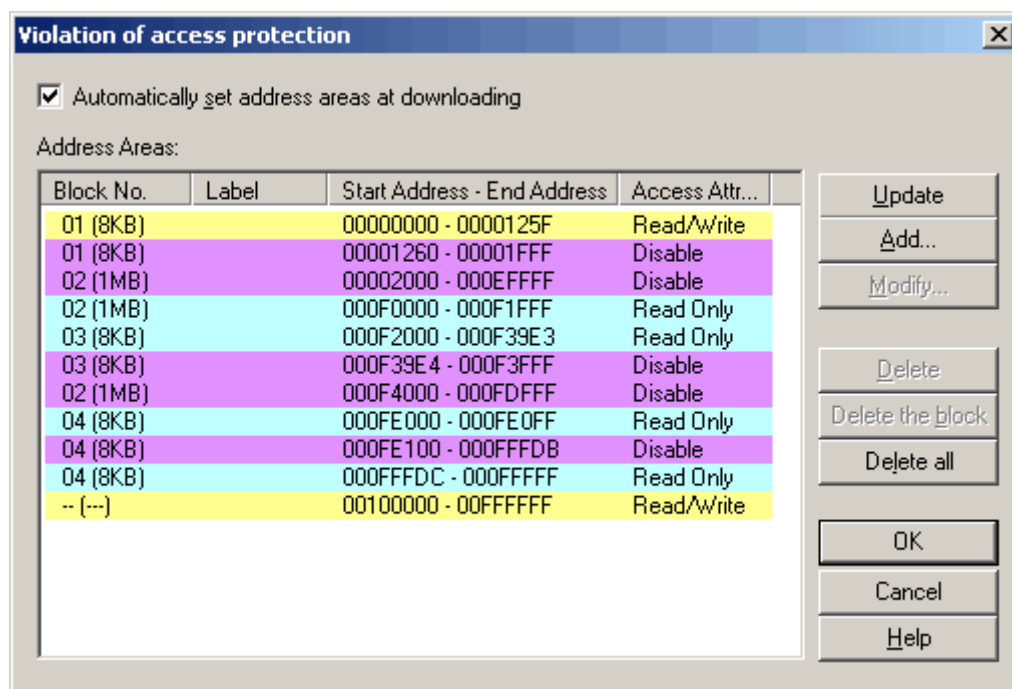

Figure 5.110 Violation of access protection dialog box

4. Click on the Update button, and the access attributes will be updated according to the section information in the downloaded module.

5. To add an access attribute manually, click the Add button. The Access protection condition dialog box shown below will appear. Specify any address range and access attribute.

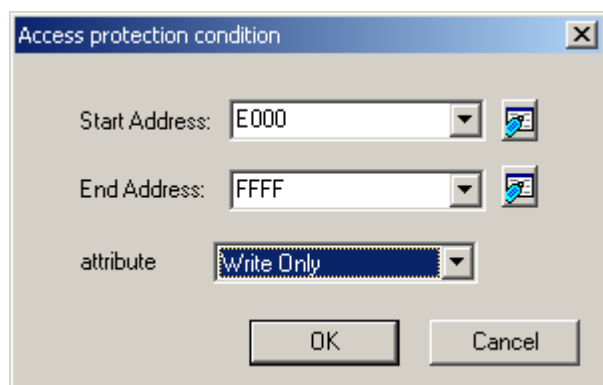

Figure 5.111 Access protection condition dialog box

6. The protected area you have added will be displayed in the Address Areas list of the Violation of access protection dialog box.

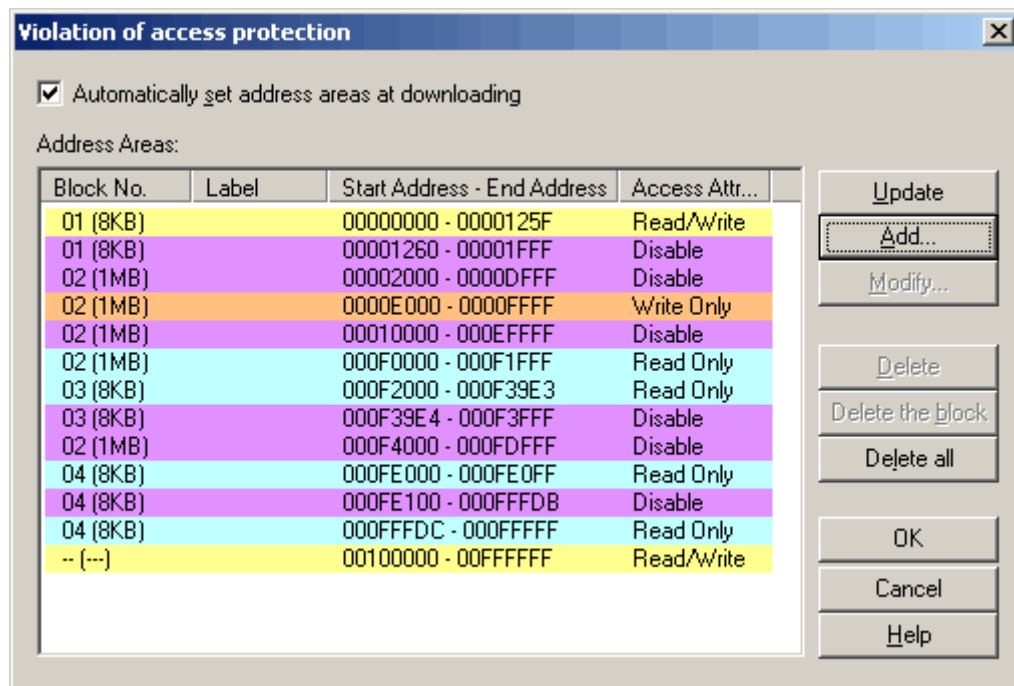

Figure 5.112 Violation of access protection dialog box

(2) From the Trace conditions dialog box

1. In the Trace Mode drop-down list of the Trace sheet, select Fill around TP. Select the Exception checkbox and then click on the Detail button.

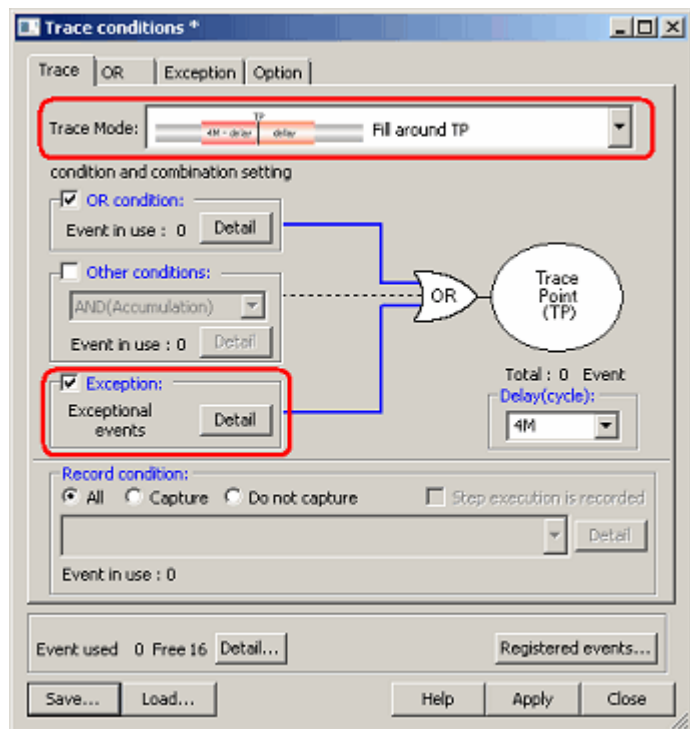

Figure 5.113 Trace conditions dialog box

2. The Exception page shown below will appear. Click on the Detail button to the right of the Violation of access protection checkbox.

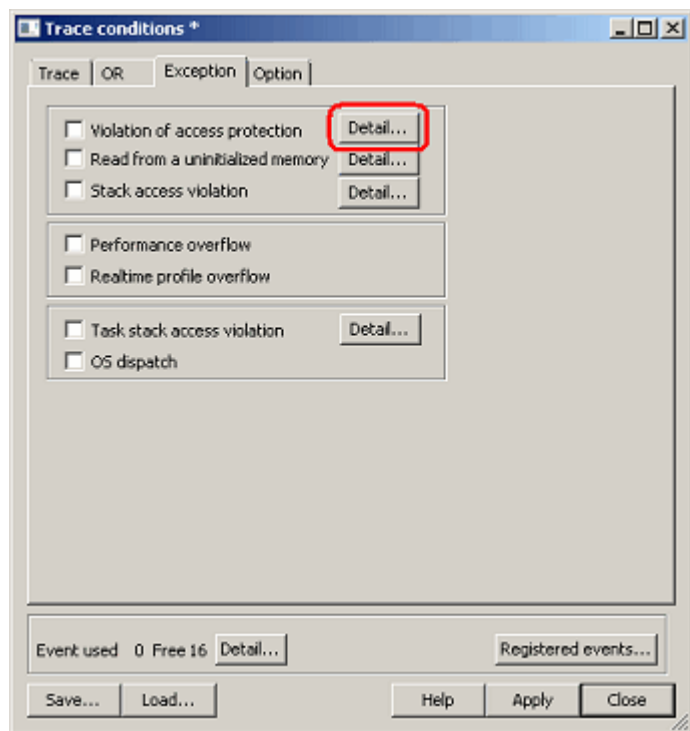

Figure 5.114 Trace conditions dialog box

3. The Violation of access protection dialog box will be displayed.

The rest of the procedure is the same as if you opened the Violation of access protection dialog box from the Hardware Break dialog box.

5.14.4 Detecting Reading from a Non-initialized Area

Reading from a non-initialized area, i.e. cases of reading from a memory location to which nothing has been written, can be detected as an error.

(1) Method of detection

Reading from a non-initialized area is detected by the RAM monitoring facility.

Allocate a RAM monitoring area to a given address range and enable error detection in that area.

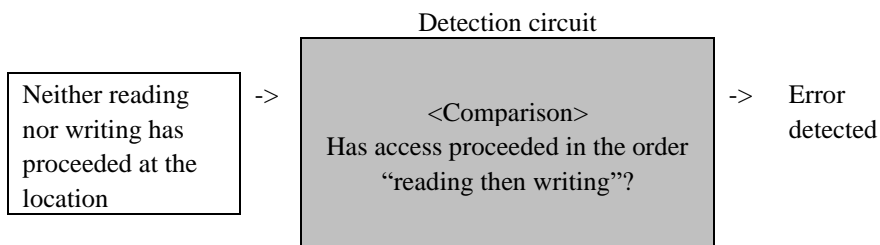

Figure 5.115 Outline of detection of reading from a non-initialized area

(2) Action taken when reading from a non-initialized area is detected

The following actions are selectable.

- Display a warning.

When the Read from uninitialized memory checkbox has been selected on the Exception Warning page of the Configuration properties dialog box, you will see a warning in the Status window and in a status bar balloon when errors of this type occur.

Data is colored in the RAM Monitor window.

- Make the detection of reading from a non-initialized area a condition of a hardware breakpoint.
- Make the detection of reading from a non-initialized area a condition of a trace point.

5.14.5 Detecting Stack Access Violations

Setting the size of the stack too small in software development raises the possibility of a program going out of control or malfunctioning. The E100 emulator actively detects abnormal access by the stack pointer.

(1) Setting stack areas

Selecting a stack section automatically assigns the addresses of the section as a stack area. Alternatively, you can enter any desired address range. Up to 4 stack areas can be specified.

(2) Initial settings when the emulator is booted up

At the time the emulator is booted up, the default section ('s') is automatically selected. However, automatic selection does not proceed until a program is downloaded, because there is no address information before this.

(3) Method of detection

The emulator monitors the value of ER7 and detects if the value points to a location outside the stack areas.

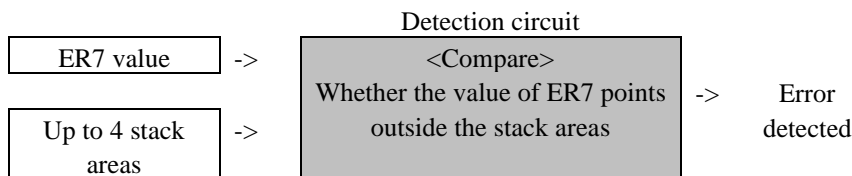

Figure 5.116 Outline of detection of a stack access violation

The emulator will detect the error if the value of the stack pointer is beyond the stack areas on

1. generation of an interrupt or return from an interrupt handler;
2. calling of a function or return from a function; or
3. the stack pointer pointing to a location outside reserved stack areas.

CAUTION

Detection does not cover cases of corruption of data within a stack area.

(4) Actions taken when a stack access violation is detected

The following actions are selectable.

- Display a warning.

When the Stack Access Violation checkbox has been selected on the Exception Warning page of the Configuration properties dialog box, you will see a warning in the Status window and in a status bar balloon when errors of this type occur.

- Make the detection of a stack access violation a condition of a hardware breakpoint.
- Make the detection of a stack access violation a condition of a trace point.

5.14.6 Detecting a Performance-Measurement Overflow

A time in performance measurement coming to exceed the maximum value can be detected as an error. Timeout case in a performance measurement is referred to as a performance overflow.

(1) Action taken when a performance-measurement overflow is detected

The following actions are selectable:

- Display a warning.

A warning is displayed in the Performance Analysis window.

The section of the program where the performance overflow occurred is marked "overflow."

When the Performance Overflow checkbox has been selected on the Exception Warning page of the Configuration properties dialog box, you will see a warning in the Status window and in a status bar balloon when errors of this type occur.

- Make the detection of a performance-measurement overflow a condition of a hardware breakpoint.
- Make the detection of a performance-measurement overflow a condition of a trace point.

5.14.7 Detecting a Realtime Profile Overflow

A time or number of passes in realtime profile measurement coming to exceed the maximum value can be detected as an error. Overflows of the counters for time and number of passes for realtime profiling are collectively referred to as realtime profile overflows.

(1) Action taken when a realtime profile overflow is detected

The following actions are selectable.

- Display a warning.

A warning is displayed in the Realtime Profile window.

The line of the function or task in which a timeout or count-out occurred is marked "overflow".

When the Realtime Profile Overflow checkbox has been selected on the Exception Warning page of the Configuration properties dialog box, you will see a warning in the Status window and in a status bar balloon when errors of this type occur.

- Make the detection of a realtime profile overflow a condition of a hardware breakpoint.
- Make the detection of a realtime profile overflow a condition of a trace point.

5.14.8 Detecting a Trace Memory Overflow

Overflows of the trace memory (4 M cycles) can be detected as errors.

(1) Action taken when a trace memory overflow is detected

The following actions are selectable.

- Display a warning.

When the Trace memory overflow checkbox has been selected on the Exception Warning page of the Configuration properties dialog box, you will see a warning in the Status window and in a status bar balloon when errors of this type occur.

- Make the detection of a trace memory overflow a condition of a hardware breakpoint.

5.14.9 Detecting Task Stack Access Violations

This facility is only available when a load module that includes an OS has been downloaded. The emulator detects an error when one task attempts writing to the task stack for another task.

(1) Initial settings when the emulator is booted up

At the time the emulator is booted up, the checkbox labeled “Automatically set address areas at downloading” is selected (flagged by a check mark). However, automatic selection does not proceed until a program is downloaded, because there is no address information before this.

(2) Action taken when a task stack access violation is detected

The following actions are selectable.

- Display a warning.

When the Task stack access violation checkbox has been selected on the Exception Warning page of the Configuration properties dialog box, you will see a warning in the Status window and in a status bar balloon when errors of this type occur.

- Make the detection of a task stack access violation a condition of a hardware breakpoint.
- Make the detection of a task stack access violation a condition of a trace point.

5.14.10 Setting a Task Stack Area

Follow the procedure below to set a task stack area.

(1) From the Hardware Break dialog box

1. Select the Exception checkbox on the Hardware Break sheet and then click on the Detail button.

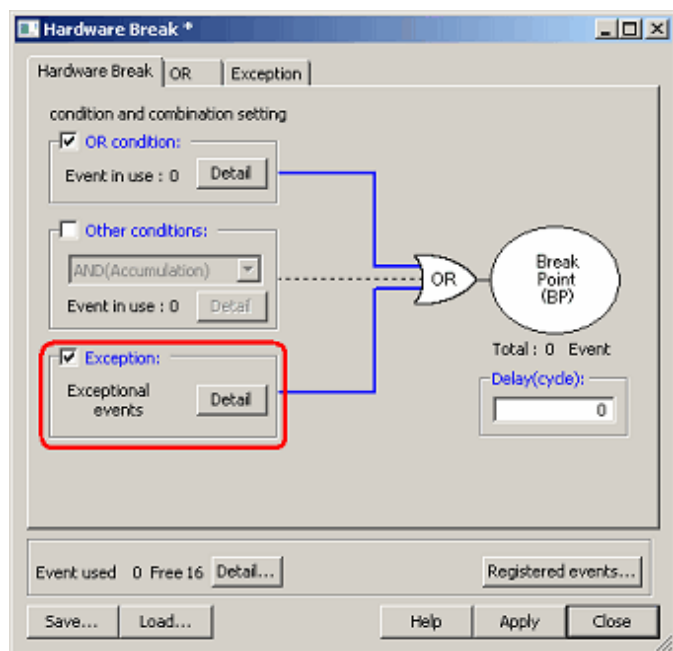

Figure 5.117 Hardware Break dialog box

2. The Exception page shown below will appear. Click on the Detail button to the right of the Task stack access violation checkbox.

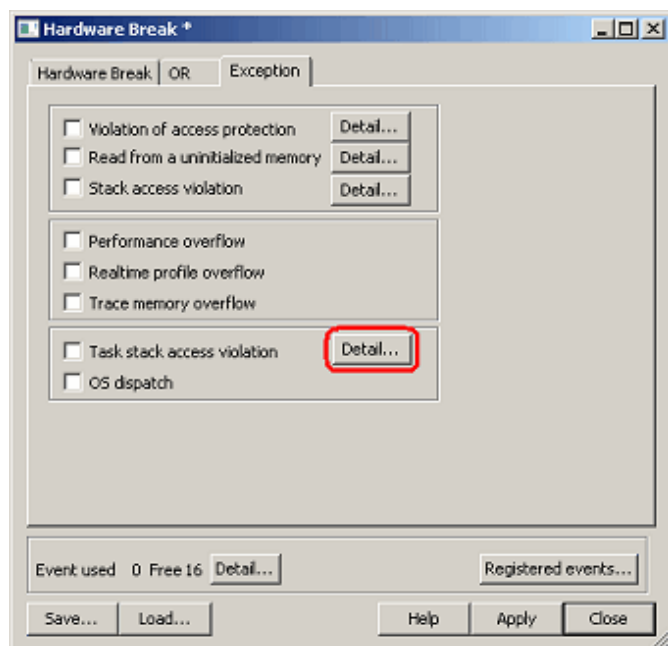

Figure 5.118 Hardware Break dialog box

3. The Violation of task stack access dialog box shown below will be displayed. To have the task stack areas automatically set when a program is downloaded, select the “Automatically set address areas at downloading” checkbox.

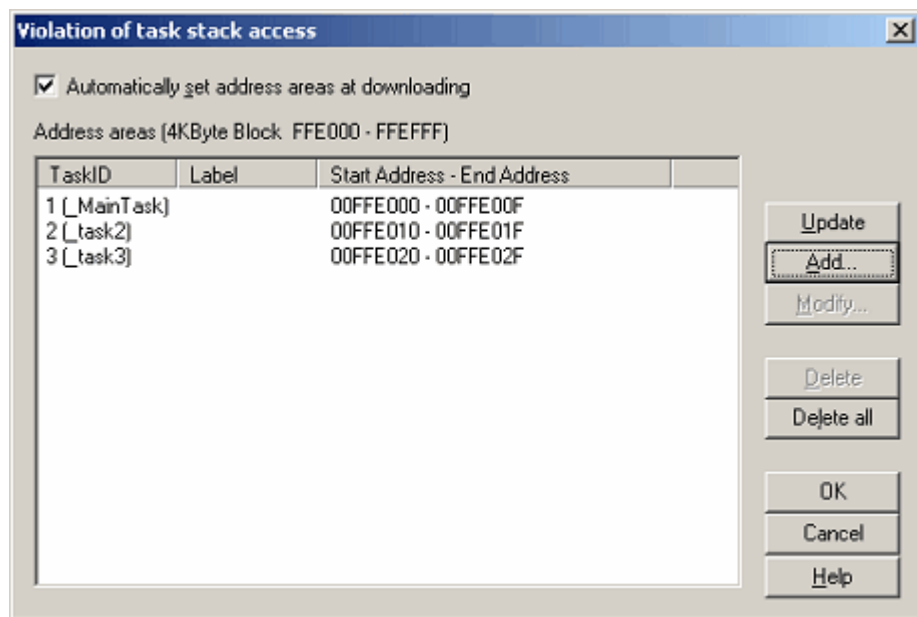

Figure 5.119 Violation of task stack access dialog box

- 4. Click on the Update button, and the task stack areas will be automatically set.
- 5. To manually add a task stack area, click on the Add button. The Task stack access condition dialog box shown below will appear. Specify any task ID and the address range of the corresponding task stack.

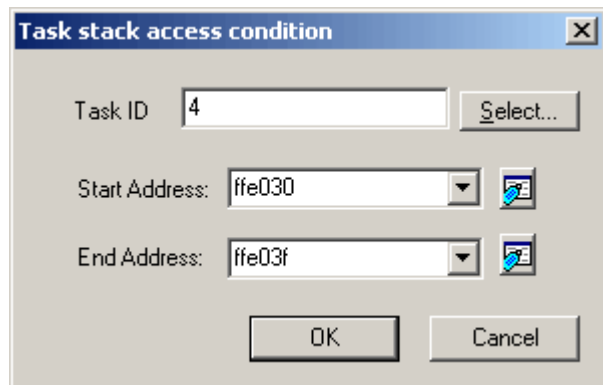

Figure 5.120 Task stack access condition dialog box

6. The task stack area (or areas) you have added will be displayed in the Address Areas list of the Violation of task stack access dialog box.

(2) From the Trace conditions dialog box

1. In the Trace Mode drop-down list of the Trace sheet, select Fill around TP. Select the Exception checkbox and then click on the Detail button.

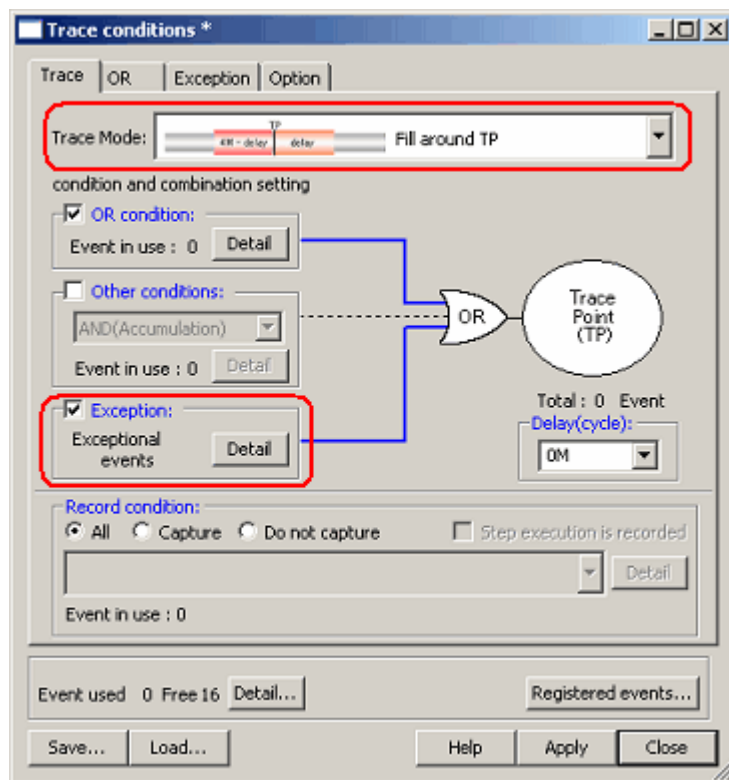

Figure 5.121 Trace conditions dialog box

2. The Exception page shown below will appear. Click on the Detail button to the right of the Task stack access violation checkbox.

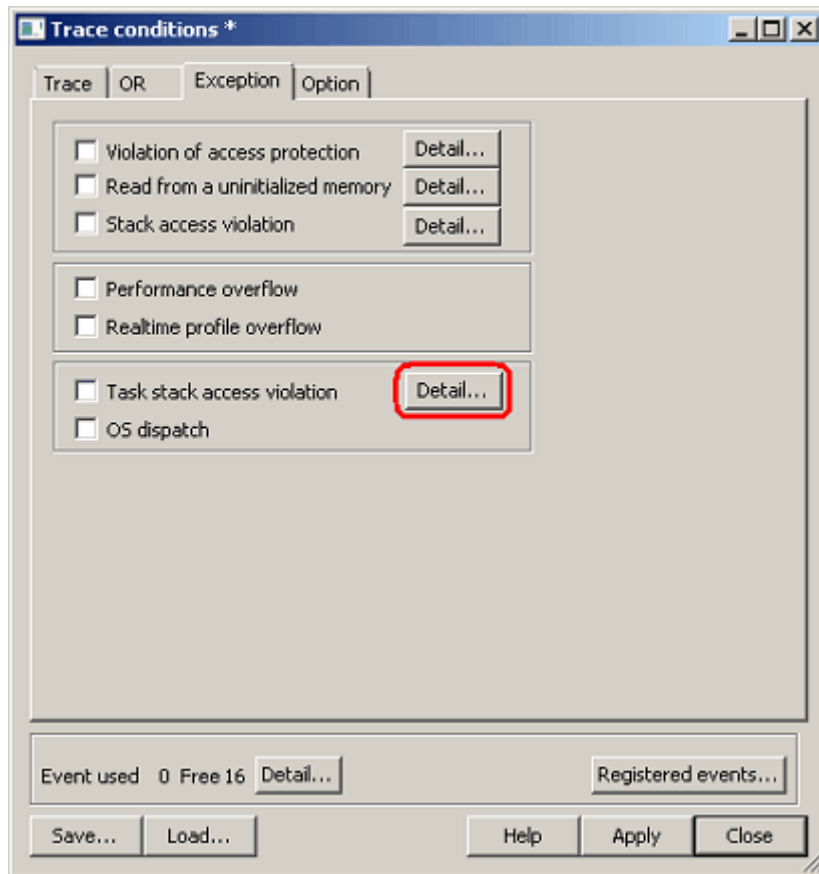

Figure 5.122 Trace conditions dialog box

3. The Violation of task stack access dialog box will be displayed. The rest of the procedure is the same as if you opened the Violation of task stack access dialog box from the Hardware Break dialog box.

5.14.11 Detecting an OS Dispatch

This facility is only available when a load module that includes an OS has been downloaded. The emulator detects the generation of task dispatch as an error.

(1) Action taken when an OS dispatch is detected

The following actions are selectable:

- Display a warning.

When the OS dispatch checkbox has been selected on the Exception Warning page of the Configuration properties dialog box, you will see a warning in the Status window and in a status bar balloon when errors of this type occur.

- Make the detection of an OS dispatch a condition of a hardware breakpoint.
- Make the detection of an OS dispatch a condition of a trace point.

5.15 Using the Start/Stop Function

The emulator can be made to execute specific routines of the user program immediately before starting and immediately after halting program execution. This function is useful if you wish to control a user system in synchronization with starting and stopping of user program execution.

5.15.1 Opening the Start/Stop Function Setting Dialog Box

The routines to be executed immediately before starting and after halting execution of the user program are specified in the [Start/Stop function setting] dialog box.

To open the Start/Stop function setting dialog box, choose Setup -> Emulator -> Start/Stop function setting... from the menu.

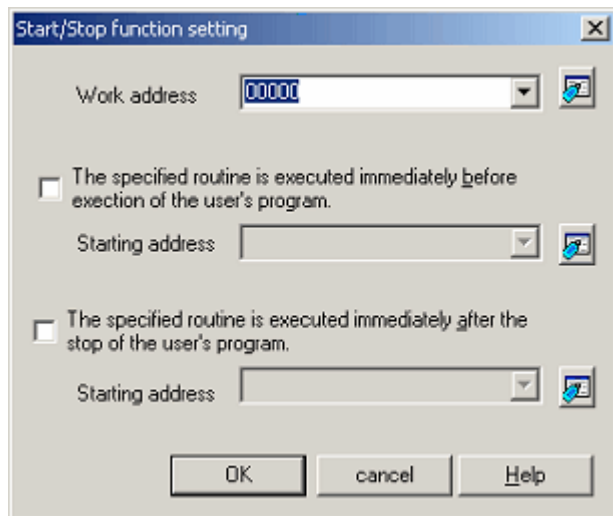

Figure 5.123 Start/Stop function setting dialog box

5.15.2 Specifying the Work address

Use this command to specify the address of a work area for use by a routine to run before the user program execution is started or after user program execution is stopped.

CAUTION

The specified address must be in the RAM area and not used by the user program.

5.15.3 Specifying the Routine to be Executed

The routines to run immediately before starting and after halting execution of the user program are specified separately.

When the [The specified routine is executed immediately before execution of the user's program] checkbox is selected, the routine specified in the [Starting address] combo box, which is below the checkbox, is executed immediately before execution of the user program starts.

When the [The specified routine is executed immediately after the stop of the user's program] checkbox is selected, the routine specified in the [Starting address] combo box, which is below the checkbox, is executed immediately after execution of the user program stops.

5.15.4 Limitations of the Start/Stop Function

The start/stop function is subject to the following limitations.

- The debugging functions listed below are not to be used while the start/stop function is in use.
 - (a) Memory setting and downloading into the program area of a routine specified as a start/stop function.
 - (b) Breakpoint setting in the program area of a specified routine
- While either of the specified routines is running, the 4 bytes of memory pointed to by the interrupt stack are in use by the emulator.

Table 5.44 Limitations to the registers and flags

Register/flag Name	Limitations
ER7 register	When a specified routine has ended, the value of this register must be restored to one that it had when the specified routine started.
CCR register, I flag	Interrupts are disabled while a specified routine is executed.

- When either of the specified routines is running, the debugging functions listed below have no effect.
 - (a) Tracing
 - (b) Break-related facilities
 - (c) RAM monitoring
- While either of the specified routines is running, interrupts other than WDT are always disabled.
- The table below shows which state the MCU will be in when the user program starts running after execution of a routine specified as a start function.

Table 5.45 MCU status at start of the user program

MCU Resource	Status
MCU general-purpose registers	These registers are in the same state as when the user program last stopped or in states determined by user settings in the Register window. Changes made to the contents of registers by the specified routine are not reflected.
Memory in MCU space	Access to memory after execution of the specified routine is reflected.
MCU peripheral functions	Operation of the MCU peripheral functions after execution of the specified routine is continued.

5.15.5 Limitations on Statements within Specified Routines

Statements within specified routines are subject to the limitations described below.

- If a specified routine uses a stack, the stack must always be the user stack.
- The processing of a specified routine must end with a return-from-subroutine instruction.
- Ensure that a round of processing by a specified routine is complete within 10 ms. If, for example, the clock is turned off and left inactive within a specified routine, the emulator may become unable to control program execution.
- The values stored in the registers at the time a specified routine starts running are undefined. Ensure that each specified routine initializes the register values.

5.16 Using the Trigger Output Function

The trigger output function is for the output of signals through an external trigger cable (this is a separately sold product). Connect the external trigger cable according to the instructions given in the user's manual for the cable.

To make the trigger output function effective, trigger pin numbers 31 to 16 must be designated for output. Note, however, that operation of a trigger pin depends on its pin number. Table 5.46 lists the trigger pin numbers and how they operate.

Table 5.46 Trigger Pin Numbers and Operation

No.	Operation
31 to 24	These pins constantly output a signal; either high or low can be selected.
23	A high-level signal is output when a breakpoint is encountered.
22	A high-level signal is output when a trace point is encountered.
21	A high-level signal is output when specific trace data is extracted or discarded.
20 to 16	An event can be specified for each of the signals and a high-level signal is output when that event occurs.

Output is at the power voltage level of the target system. If the MCU in use has two power supplies, the level on VCC1 will be applicable.

5.16.1 Using the External Trigger Cable for Output

You can specify input and output through the external trigger cable on the System page of the Configuration properties dialog box. Select the 'EXT 0-15 INPUT EXT16-31 OUTPUT' radio button for 'External trigger cable'.

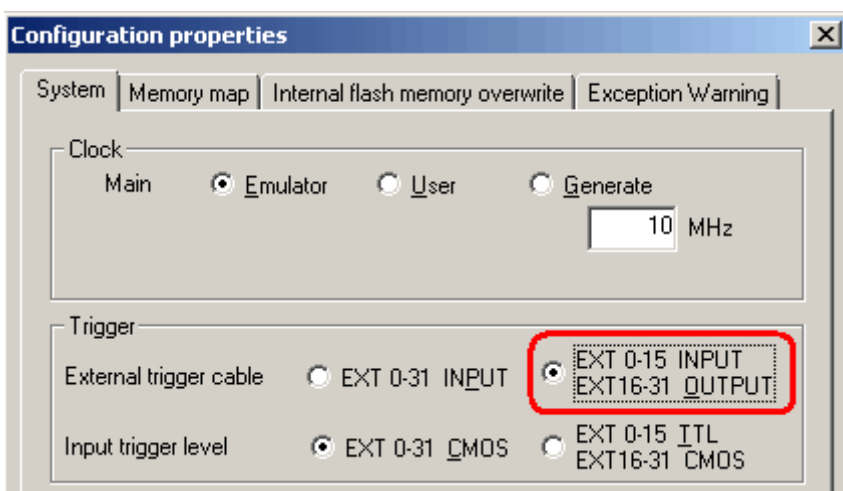



Figure 5.124 Configuration properties dialog box (System page)

5.16.2 Opening the Trigger Output Conditions Dialog Box

Choose [Event -> Trigger Output Conditions] from the View menu, or click on the 'Trigger Output Conditions' toolbar button .

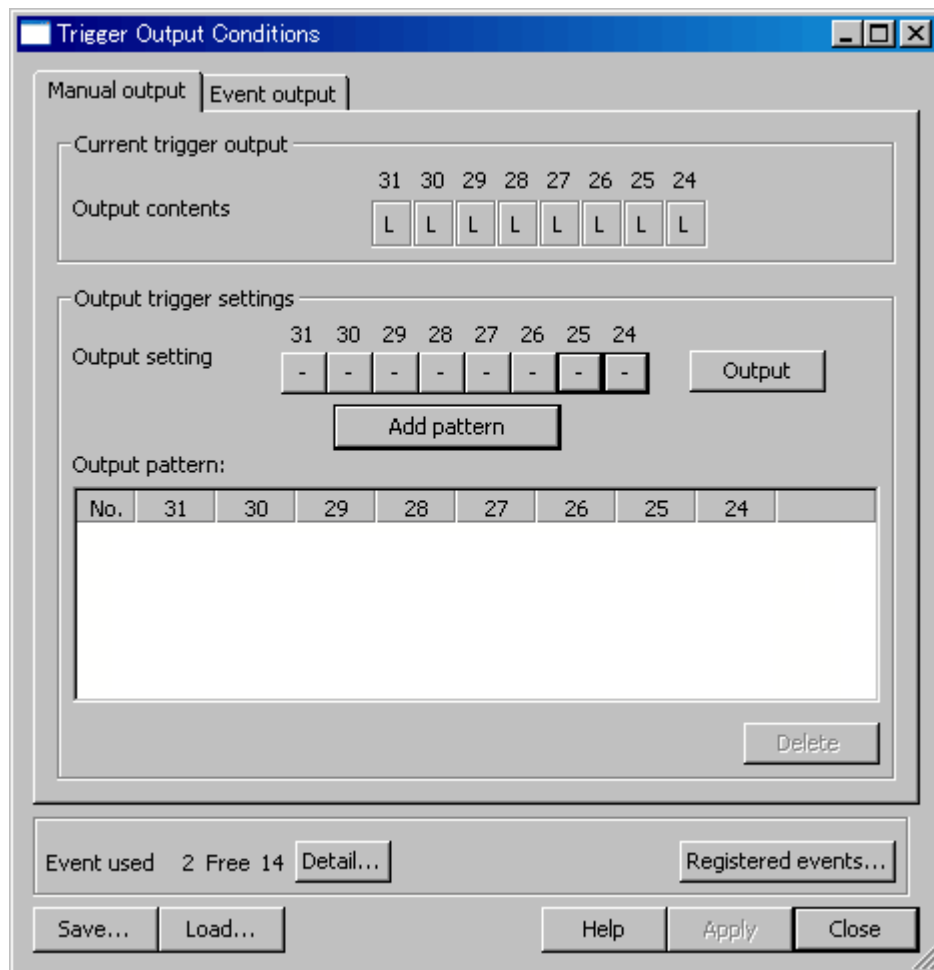

Figure 5.125 Trigger Output Conditions dialog box

Note that you cannot open the Trigger Output Conditions dialog box in either of the following cases.

- 'EXT 0-31 INPUT' has been selected on the System page of the Configuration properties dialog box.
- An external trigger cable is not connected.

5.16.3 Manual Setting for Output through Trigger Pins 31 to 24

Make the manual settings for output through trigger pins 31 to 24 on the Manual output page.

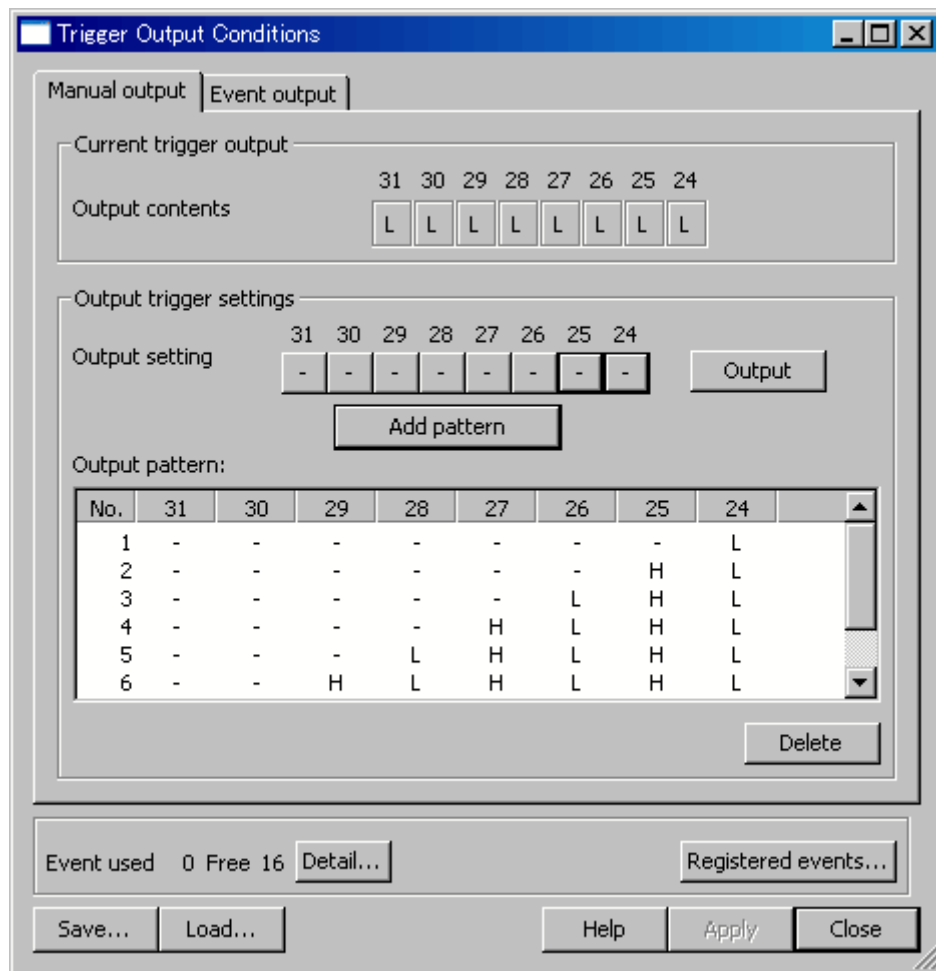

Figure 5.126 Trigger Output Conditions dialog box (Manual output page)

(1) Display of output states: 'Output contents'

'Output contents' indicates the current signal levels on trigger pins 31 to 24.

H: High

L: Low

(2) 'Output setting'

'Output setting' indicates the levels of signals to be output through trigger pins 31 to 24. Clicking on one of these buttons changes the state of the corresponding pin in the following order.

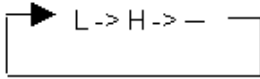

L: Low

H: High

-: The previous setting is retained.

When the Trigger Output Conditions dialog box is opened, the states of all signals in the 'Output setting' section are always indicated as '-', whether the previous setting was L or H.

(3) Starting output of signals

Click on the 'Output' button to validate the settings and start output of signals.

(4) Saving output patterns

You can save the settings on trigger pins 31 to 24 and reflect a saved setting as the 'Output setting'. This simplifies operations. After making settings for an 'Output setting', click on the 'Add pattern' button. The new setting will be added as the last line in the 'Output pattern' list.

Up to 256 patterns can be added.

Double-clicking on a line in the 'Output pattern' list reflects the information on the line as the 'Output setting'.

The order of the lines (patterns) can be changed by dragging and dropping.

To delete a pattern, select the line and click on the 'Delete' button.

5.16.4 Setting for Output through Trigger Pins 20 to 16

The Event output page allows manual setting for output through trigger pins 20 to 16.

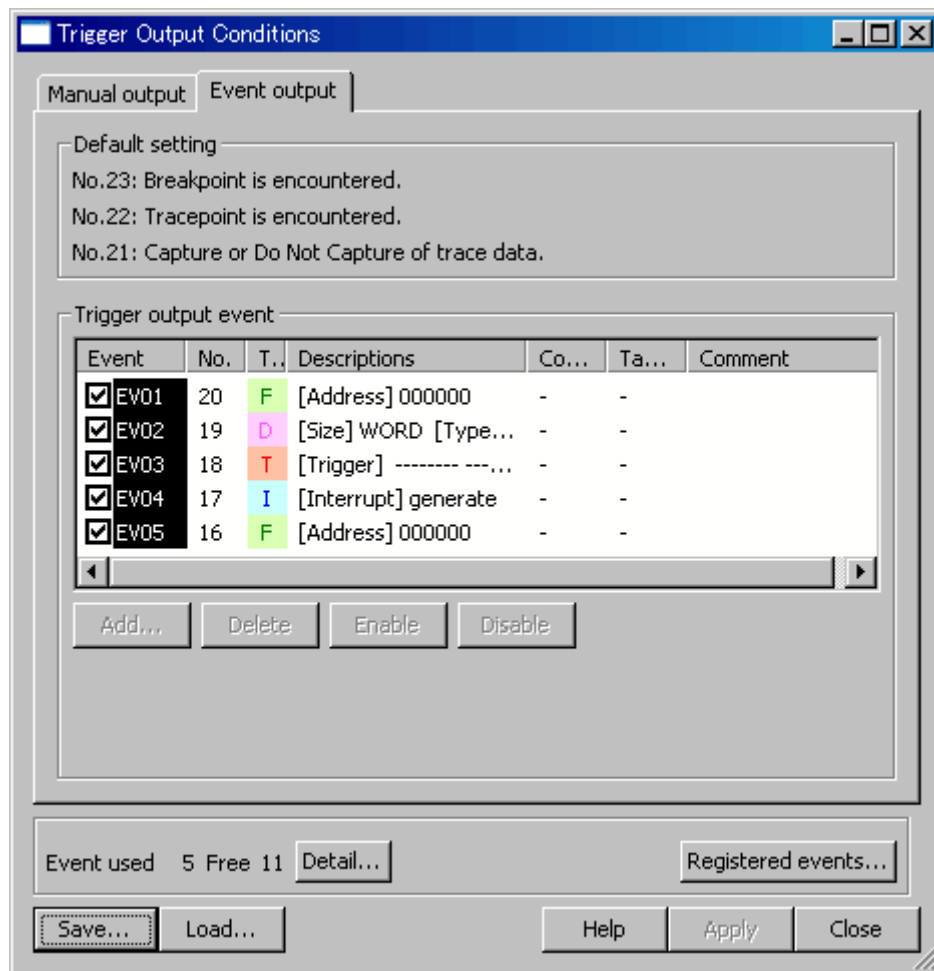

Figure 5.127 Trigger Output Conditions dialog box (Event output page)

(1) Default setting

'Default setting' indicates the trigger output conditions on pins 23 to 21. These pins are always enabled. Signals are output through these pins when the respective conditions are satisfied. Table 5.47 gives details on how the conditions control output.

Table 5.47 Trigger Output Conditions and Output

No.	Condition	Output
23	A breakpoint is encountered	Continued output of a high-level signal is started.
22	A trace point is encountered	A high-level signal is output only during cycles in which the trace-point condition is satisfied.
21	Specific trace data is extracted or deleted	A high-level signal is output only in cycles where trace data is being extracted or discarded.

(2) Trigger output event

You can specify an event for trigger pins 20 to 16. A high-level signal will only be output while the event is occurring.

CAUTION

The actual trigger output follows event detection after some delay. The number of cycles of delay varies with the product. The delay for trigger output in the R0E424270MCU00 is 9 cycles.

5.16.5 Events

For details on the setting of events, refer to, “5.7 Using Events” (page 108).

5.17 Measuring the Execution Times in a Specific Section

Measurement of the execution times in a specific section of the program is possible. This facility takes the trace data for instruction fetching at event points (start and end) used to specify the extraction of trace data and then outputs the timestamps and their differences to a file in a format that is editable in Microsoft Excel.

Timestamps for up to 2-M cycles of trace data will be output to the file.

Each section is defined by two events (start and end events) and up to eight sections are specifiable.

Follow the procedure below to measure the execution times in a specific section of the program.

CAUTION

This facility is only supported by command-line operation. To measure the execution times for a specific section of the program, be sure to specify the events on the same line as the command. Such measurement is not possible for events that have been specified in the [Trace conditions] dialog box. Before using this facility, disable all events registered as hardware-break, tracing, and performance-measurement conditions.

Follow the following procedures to measure the execution times in a specific section of the program.

5.17.1 Setting Trace Conditions

Trace conditions can be specified on the command line.

(1) Selecting the mode of tracing

Select ‘fill until stop’, ‘fill until full’, or ‘fill around TP’ as the trace mode. Examples of the commands are given below.

```
event_trace_mode fr (fill until stop)
```

```
event_trace_mode fu (fill until full)
```

```
event_trace_mode po (fill around TP)
```

(2) Specifying the start and end events

Specify the start and end events that define the points where the desired section starts and ends, along with the following conditions.

Do not select any other event type or address condition.

Event type: Instruction fetch
Address condition: Specified value (=)

To specify sections from H'1000 to H'10FF and from H'2000 to H'20FF, for example, enter commands as follows.

```
event_set ev1 f address eq 0x001000 cnt 0x1  
event_set ev2 f address eq 0x0010FF cnt 0x1  
event_set ev3 f address eq 0x002000 cnt 0x1  
event_set ev4 f address eq 0x0020FF cnt 0x1
```

(3) Selecting an option for 'Record condition'

You should specify extraction of trace data during the event. No other conditions should be selected.

An example of a command that specifies 'Extraction' and 'Duration of an event' for the events set in step (2) is given below.

```
event_trace_acquisition apo ev1 ev2 ev3 ev4
```

(4) Selecting an option for tracing

Select 'Event number' as an option for tracing. Do not select any other options. An example is given below.

```
event_trace_option ev
```

5.17.2 Acquiring Trace Data

Run the user program and acquire the trace data.

5.17.3 Specifying a Section

You can use the TRACE_EXECUTE_SECTION_SET command to specify a section. An example of commands to specify section 1 that starts with event 1 and ends with event 2 and section 2 that starts with event 3 and ends with event 4 is given below.

```
trace_execute_section_set 1 start ev1 end ev2  
trace_execute_section_set 2 start ev3 end ev4
```

5.17.4 Saving the Execution Times to a File

After the trace data has been acquired, you can use the TRACE_EXECUTE_SAVE command to save the execution times in the specified section to a file with extension .csv.

The command description given below is an example where the execution times for sections 1 and 2 are saved in result.csv under the configuration directory.

```
trace_execute_save 1 2 $(CONFIGDIR)\result.csv
```

The contents of the .csv file opened in Microsoft Excel will be as follows.

Example:

	A	B	C	D	E
1	<START1>	< END1 >			
2	1000	10FF			
3	Execution time	Start time	End time		
4	100	0	100		
5	102	1000	1102		
6	100	2100	2200		
7	98	3000	3098		
8	1200	5000	6200		
9	103	7000	7103		
10	-	8200	-		
11	1201	9000	10201		
12					
13	<START2>	< END2 >			
14	2000	20FF			
15	Execution time	Start time	End time		
16	100	0	100		
17	102	1000	1102		
18	100	2100	2200		
19	98	3000	3098		
20	1200	5000	6200		
21	103	7000	7103		
22	-	8200	-		
23	1201	9000	10201		
24					

Section 1 (start: 0x1000, end: 0x10FF)

Within the acquired data, an execution time is not given if a start event has no corresponding end event.

Section 2 (start: 0x2000, end: 0x20FF)

Figure 5.128 .csv file opened in Microsoft Excel

The execution time, in nanoseconds, is saved in the file.

Example:

1h 23 m 45 s 678 ms 901 μs 234 ns = 01:23:45.678.901.234 -> 5025678901234

[CAUTION]

Measurement of execution times for specific sections is not possible with events set in the Trace conditions dialog box, so be sure to specify the events on the command line.

In command files, execute the TRACE_WAIT command before using the TRACE_EXECUTE_SAVE command. The TRACE_WAIT command makes the emulator wait for successful acquisition of the trace data.

For details on commands, refer to the online help information.

6. Troubleshooting (Action in Case of an Error)

6.1 Flowchart for Remediation of Trouble

Figure 6.1 shows the flowchart for remediation of trouble arising between activation of the power supply to the emulator system and the emulator debugger starting up. Go through the checks with the user system disconnected. For the latest FAQs, visit the Renesas Tools Homepage.

<https://www.renesas.com/tools>

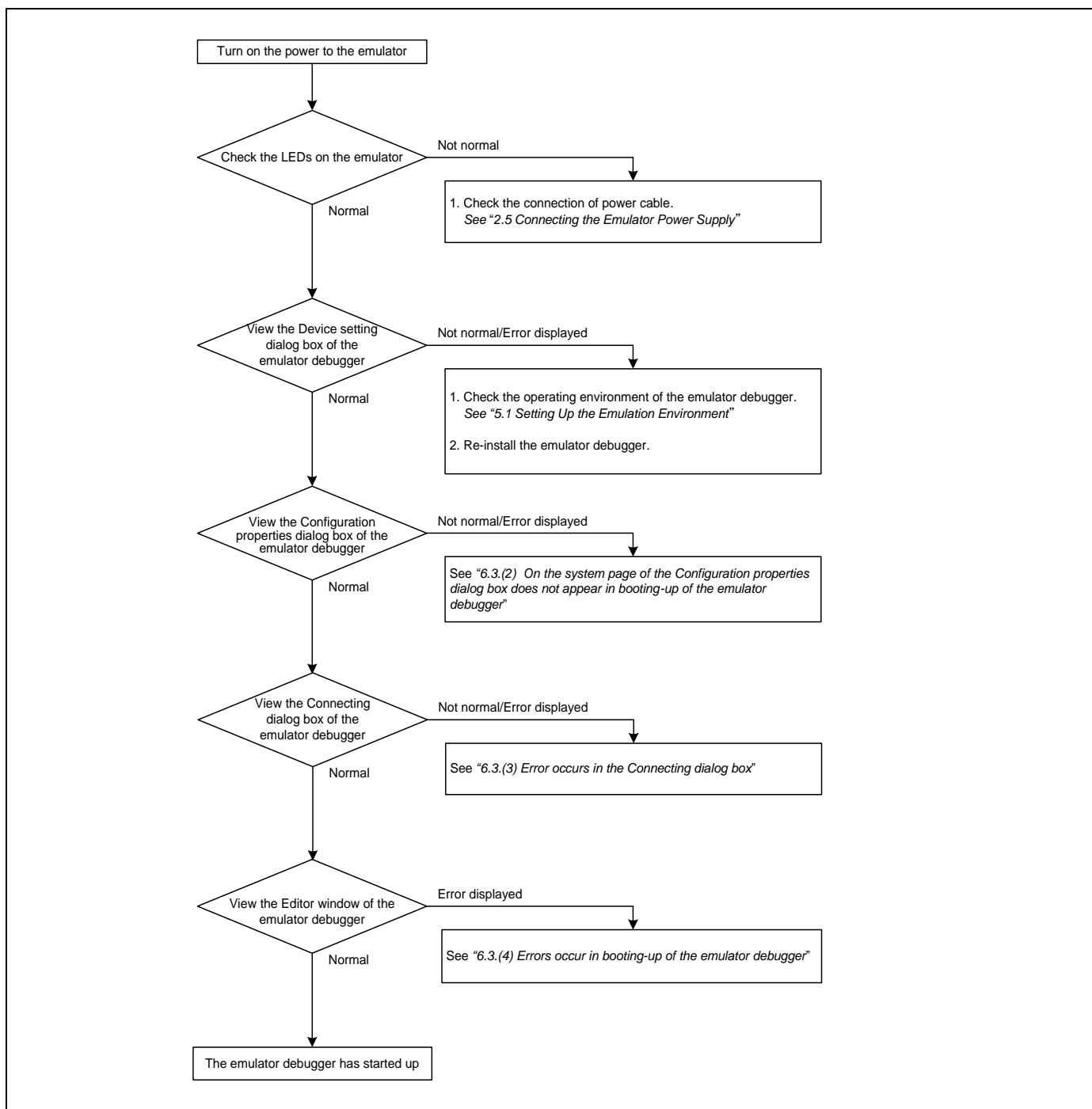

Figure 6.1 Flowchart for remediation of trouble

6.2 Error in Self-checking

When an error occurs in self-checking, check the following items.

- (1) Re-check the connection between the E100 emulator main unit and the MCU unit.
- (2) Download the proper firmware again.
- (3) Check the error log from self-checking by the debugger software, and refer to the instructions given therein (see Figure 6.2).

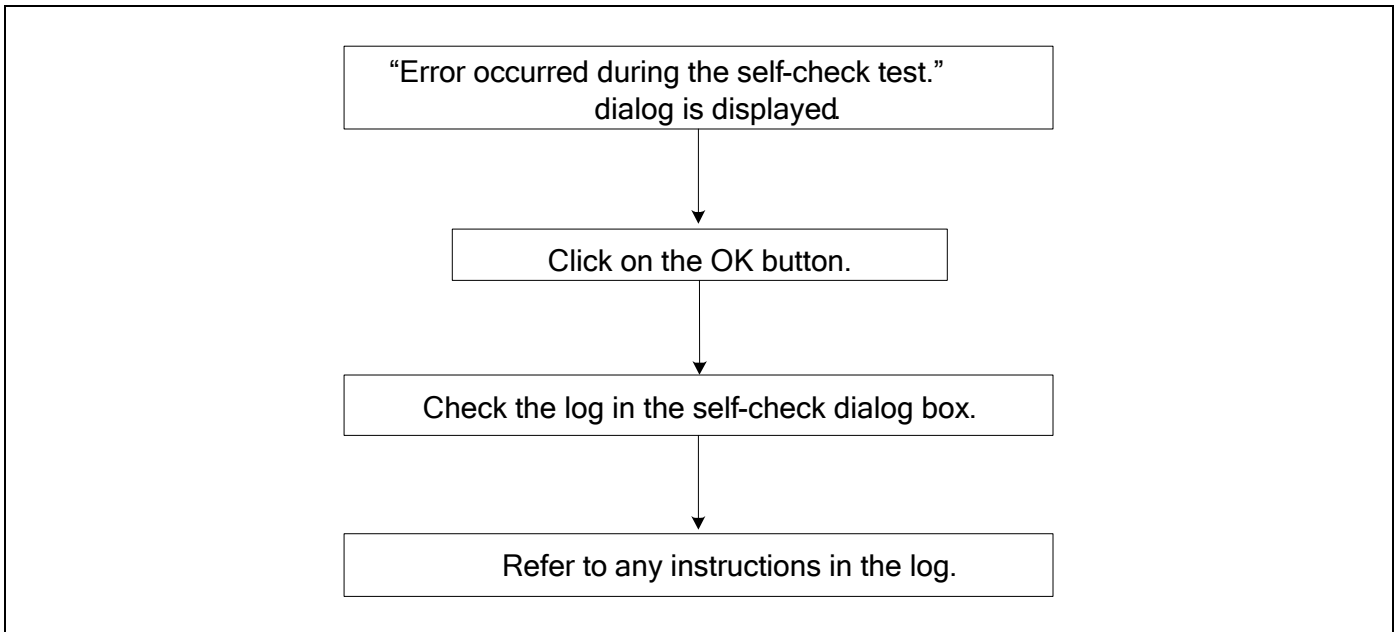

Figure 6.2 Flowchart for checking of an error in self-checking

IMPORTANT

Notes on Self-checking:

- Disconnect the MCU unit from the user system before you start self-checking.
- If the results of self-checking are not normal (excluding status errors of the target system), the product may have been damaged. Contact your local distributor.

6.3 Errors Reported in Booting-up of the Emulator

(1) States of the LEDs on the E100 are incorrect

Table 6.1 Points to check for errors indicated by incorrect states of the LEDs on the E100

Error	Connection to the user system	Point to check
SAFE LED remains lit.	-	Check that the USB cable is connected. <i>See "2.4 Connecting the Host Machine" (page 29).</i>
SAFE LED does not light up.	-	Re-check the connection between the E100 and the MCU unit. <i>See "2.3 Connecting the MCU Unit to and Disconnecting it from the E100 Emulator Main Unit" (page 28).</i>
Target Status POWER LED does not light up.	Connected	Check that power (Vcc) is being correctly supplied to the user system and that the user system is properly grounded (GND).
Target Status RESET LED does not go out.	Connected	(1) Check that the reset pin of the user system is being pulled up. (2) When using the emulator without the user system, check if a converter board is disconnected from the emulator.

(2) Configuration Properties Dialog Box Does Not Appear in Booting-up of the Emulator Debugger

Table 6.2 Points to check for errors in booting-up of the emulator debugger (1)

Error	Point to check
Communication initialize error	Check all emulator debugger settings and the connection of the interface cable.
A communication error.	See "4. Preparation for Debugging" (page 71).

(3) Error Occurs in the Connecting Dialog Box

Table 6.3 Points to check for errors in booting-up of the emulator debugger (2)

Error	Point to check
MCU board is not connected.	Re-check the connection between the E100 and the MCU unit. See "2.3 Connecting the MCU Unit to and Disconnecting it from the E100 Emulator Main Unit" (page 28).
The system configuration of the E100 emulator is not corresponding to the content of the E100.ENV file.	The combination between the emulator software and the MCU unit is not correct. Refer to the release notes of the emulator software, and confirm the combination between the emulator software and the MCU unit.
A timeout error. The MCU's internal clock is halted. Is system reset issued?	Check the oscillation of the oscillator module mounted on the MCU unit, and confirm that the oscillator module is properly mounted.
A timeout error. No clock signal is supplied to the MCU. Is system reset issued?	
A timeout error. The power supply to the MCU is off. Is system reset issued?	Check that power is being correctly supplied to the user system and that the user system is properly grounded.

(4) Errors Occur in booting-up of the emulator debugger

Table 6.4 Points to check for errors in booting-up of the emulator debugger (3)

Error	Point to check
A timeout error.	(1) Check that the NQPACK etc. mounted on the user system is soldered properly. (2) Check that the connector is installed properly to the user system.

6.4 How to Request Support

After checking the items under "6. Troubleshooting (Action in Case of an Error)" (page 211), fill in the text file which is available for downloading at the following URL, then send the information to your local distributor.

<https://www.renesas.com/contact>

For a prompt response, please fill in the following information:

(1) Operating environment

- Operating voltage: _____ [V]
- Operating frequency: _____ [MHz]
- Clock supply to the MCU: Internal oscillator/External oscillator

(2) Condition

- The emulator debugger starts up/does not start up
- The error is detected/not detected in self-checking
- Frequency of errors: always/frequency (_____)

(3) Details of request for support

7. Hardware Specifications

This chapter describes specifications of the MCU unit.

7.1 Target MCU Specifications

Table 7.1 lists the specifications of target MCUs which can be debugged with the MCU unit.

Table 7.1 Specifications of target MCUs for the R0E424270MCU00

Item	Description
Applicable MCU series	H8S family H8S/2400 series
Evaluation MCU	R4E2427-EVA
Applicable MCU mode	Single-chip mode, on-chip ROM enabled extended mode, and on-chip ROM disabled extended mode
Size of the ROM, RAM, and data flash areas	Internal flash ROM: 0, 128, 256, 384, or 512 Kbytes Internal RAM: 32, 48, 64, 80, 96, or 128 Kbytes Internal data flash: 0, 1, 2, 3, 4, 5, 6, or 8 Kbytes
Power supply voltage	3.0 to 3.6 V, or 4.5 to 5.5 V
Maximum operating frequency	33 MHz

7.2 Differences between the Actual MCU and the Emulator

Differences between the actual MCU and the emulator are described below. When using the MCU unit in debugging an application for the corresponding MCU, take care with regard to the following points.

IMPORTANT

Note on Differences between the Actual MCU and the Emulator:

- Operation of the emulator system differs from that of the actual MCU in the ways listed below.
 - (1) Values of general-purpose registers after a reset

Register Name	MCU	Emulator
PC	Reset vector value	Reset vector value
ER0 to ER6	Undefined	Undefined
ER7 (SP)	Undefined	H'10
CCR	The I mask bit is 1.	The I mask bit is 1.
Other	Undefined	Undefined

- (2) Oscillator circuit

If the oscillator circuit has been set up by connecting an oscillator between pins XTAL and EXTAL, the pitch-converter board between the evaluation MCU and the user system makes oscillation impossible.

- (3) A/D converter

Results from the A/D converter differ from those on the actual MCU because of the pitch-converter board etc. between the evaluation MCU and the user system.

Note on RESET# Input:

- A low-level input to the RES# pin from the user system is only accepted during the execution of a user program (i.e. only while the RUN status LED on the top panel of the E100 is lit).

Note on Voltage Detection Circuit:

- The MCU unit differs from the actual MCU because of the pitch converter board etc. between the evaluation MCU and the user system. Final evaluation of the voltage detection circuit (generation of low-voltage-detection interrupt, low-voltage-detection reset, etc.) must be executed on the actual MCU.

Note on Emulation in Hardware Standby Mode:

- Emulation is not possible in hardware standby mode. Since the STBY# pin is always fixed high in the emulator, the emulator does not enter standby mode even if the level on the STBY# pin in the user system is low. You can use the Extended Monitor window to check the level of the signal on the STBY# pin in the user system.

IMPORTANT

Notes on Maskable Interrupts:

- Even if a user program is not being executed (including when run-time debugging is being performed), the evaluation MCU is executing a debug control program. Therefore, the timers and other components do not stop running. If a maskable interrupt is requested while the user program is not being executed (including when run-time debugging is being performed), the maskable interrupt request cannot be accepted, because interrupts have been disabled by the emulator. The interrupt request is accepted immediately after execution of the user program starts.
- Take note that peripheral I/O interrupt requests are not accepted while the user program is not being executed (including when run-time debugging is being performed).

Note on Software Reset:

- When stepping ([Step In], [Step Over], or [Step Out]) through code for processing of a software reset is attempted, the software reset will not occur.

Notes on Flash Memory:

- Of the software commands for the flash memory, the emulator does not support the read lock-bit command. If this command is issued, the emulator cannot refer to the correct lock-bit data.
- The performance of the flash memory (e.g. times taken for programming and erasure and the number of times the flash memory can be programmed or erased) differs from that for the actual MCU.

Note on Final Evaluation:

- Be sure to evaluate your system with an evaluation MCU. Before starting mask production, evaluate your system and make final confirmation with a CS (Commercial Sample) version of the MCU.

7.3 Connection Diagram

7.3.1 Connection Diagram for the R0E424270MCU00

Figure 7.1 shows a partial circuit diagram of the connections of the R0E424270MCU00. This diagram mainly shows the circuitry to be connected to the user system. Other circuitry, such as that for the emulator's control system, has been omitted. See this diagram for reference when you use the R0E424270MCU00.

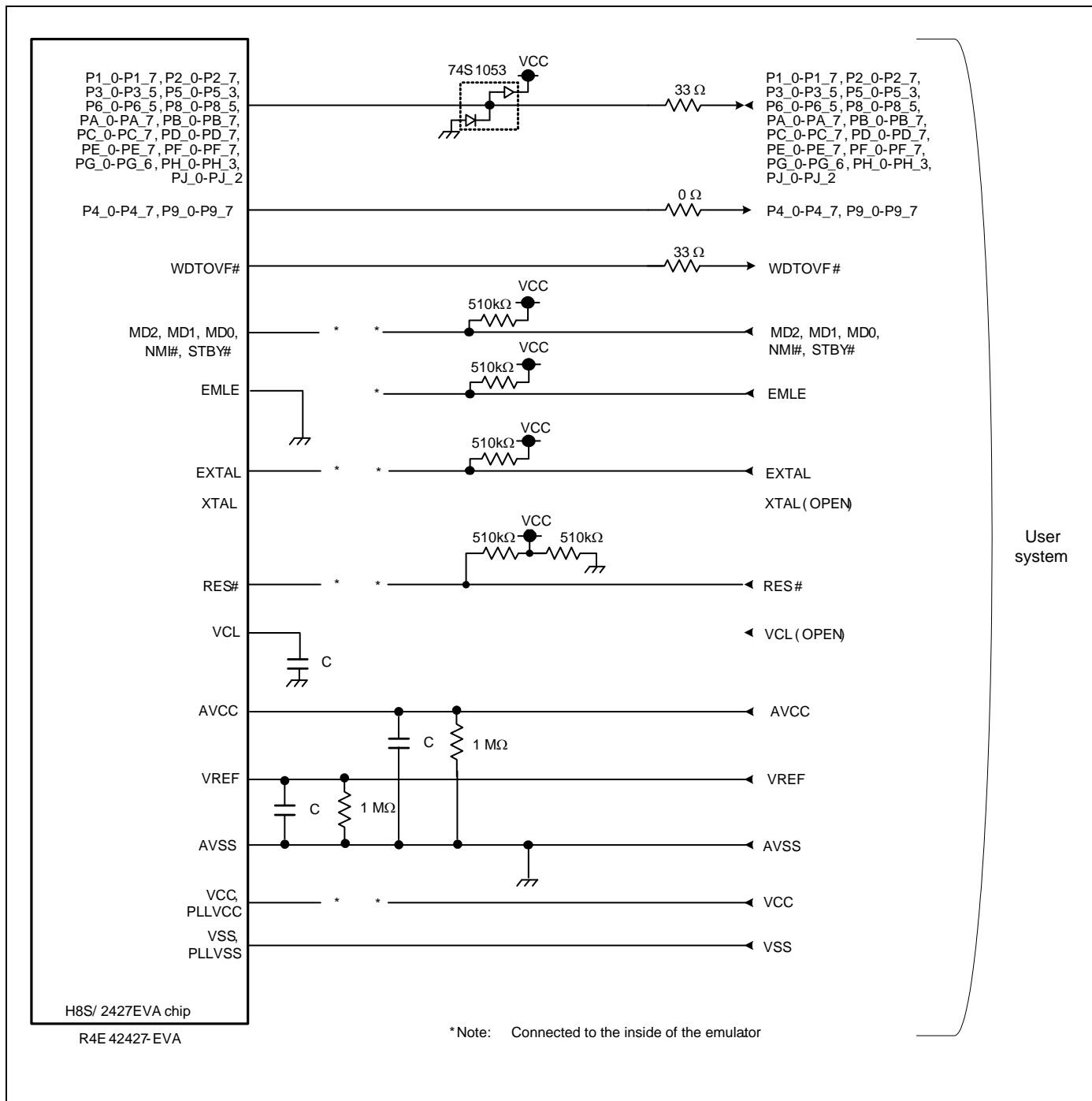

Figure 7.1 Connection diagram for R0E424270MCU00

7.4 External Dimensions

7.4.1 External Dimensions of the E100 Emulator

Figure 7.2 shows the external dimensions of the E100 emulator.

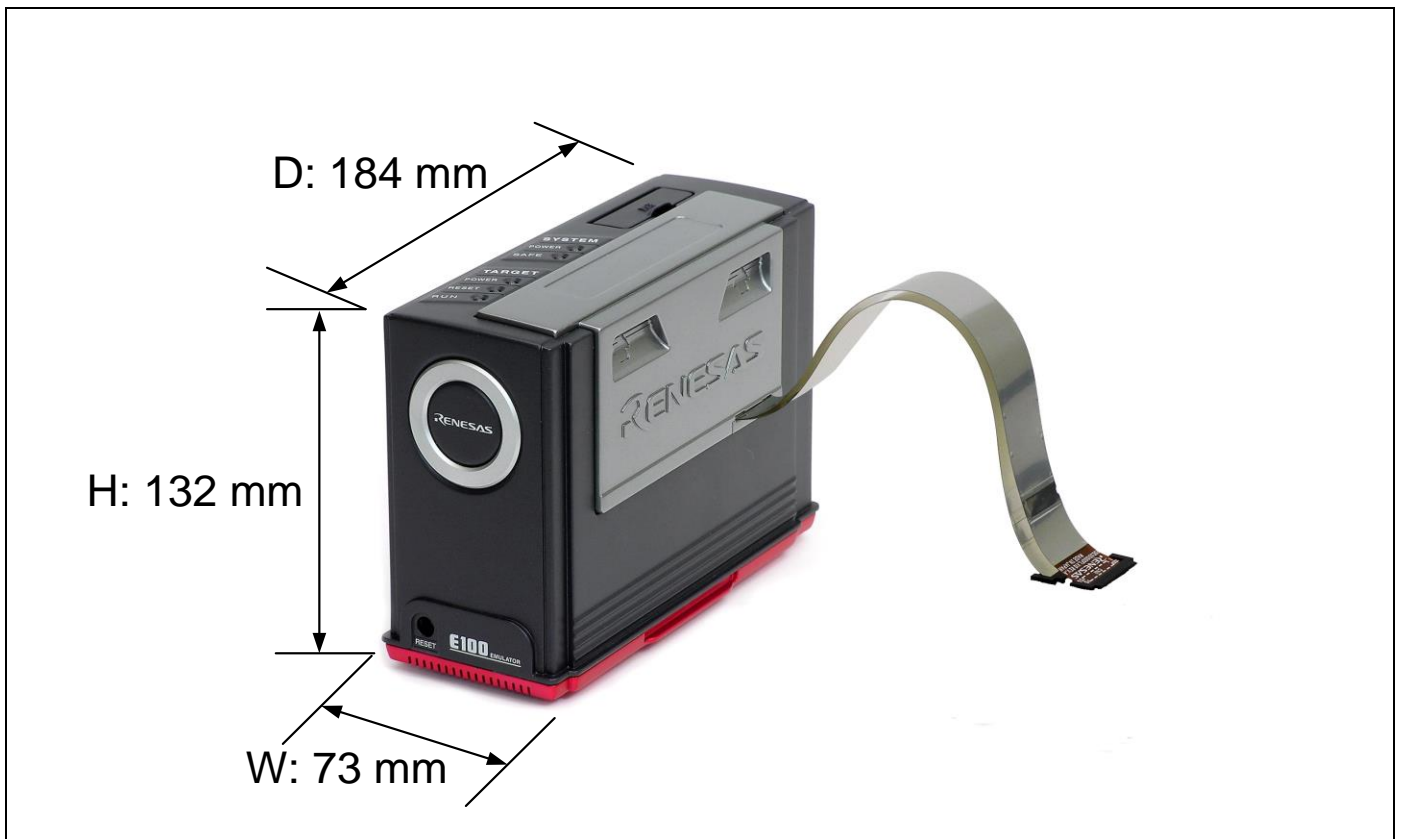

Figure 7.2 External dimensions of the E100 emulator

7.4.2 External Dimensions of the Converter Board (R0E424270CFLE0)

Figure 7.3 shows external dimensions and a sample pad pattern of the converter board (R0E424270CFLE0) for an 80-pin 0.65-mm pitch LQFP.

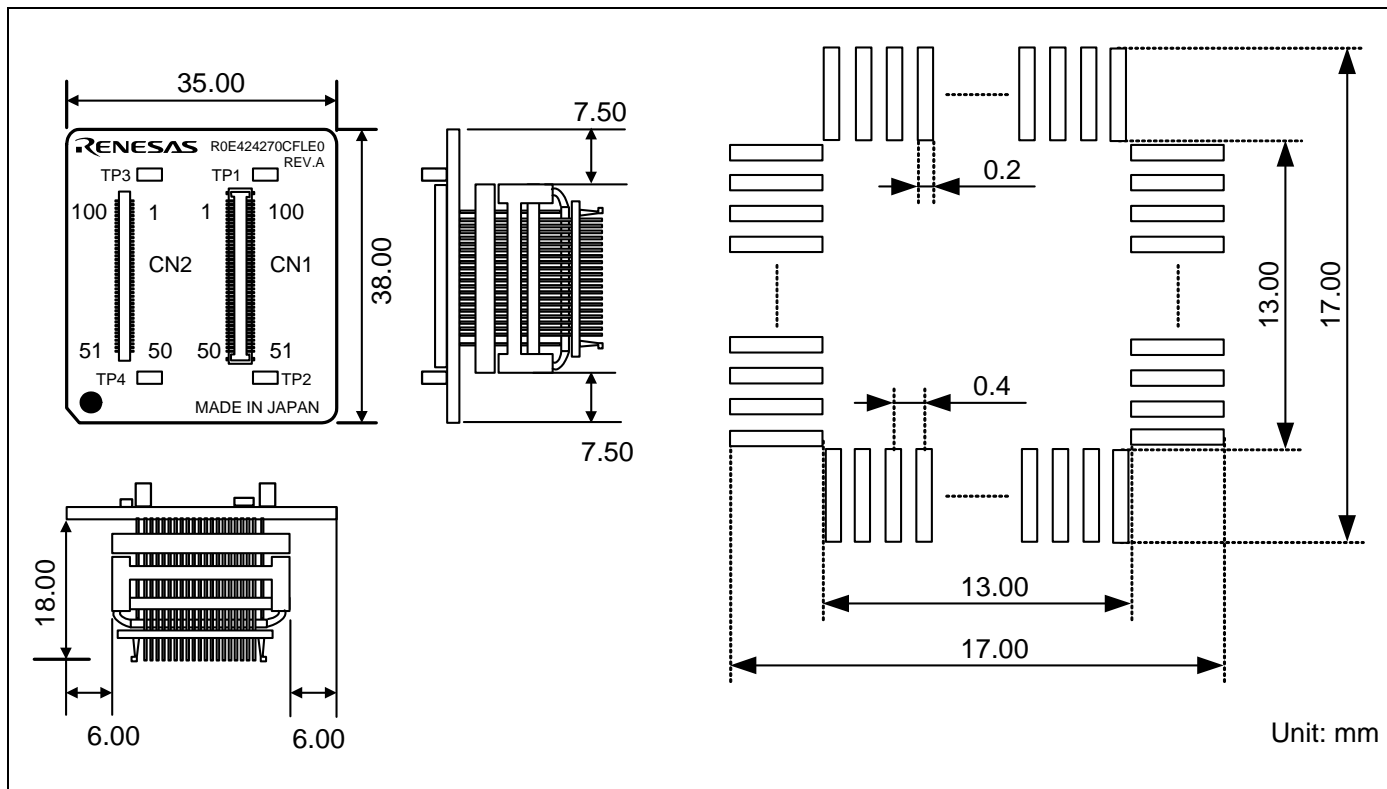

Figure 7.3 External dimensions and a sample pad pattern for the R0E424270CFLE0

7.4.3 External Dimensions of the Converter Board (R0E424270CFKE0)

Figure 7.4 shows external dimensions and a sample pad pattern of the converter board (R0E424270CFKE0) for an 80-pin 0.5-mm pitch LQFP.

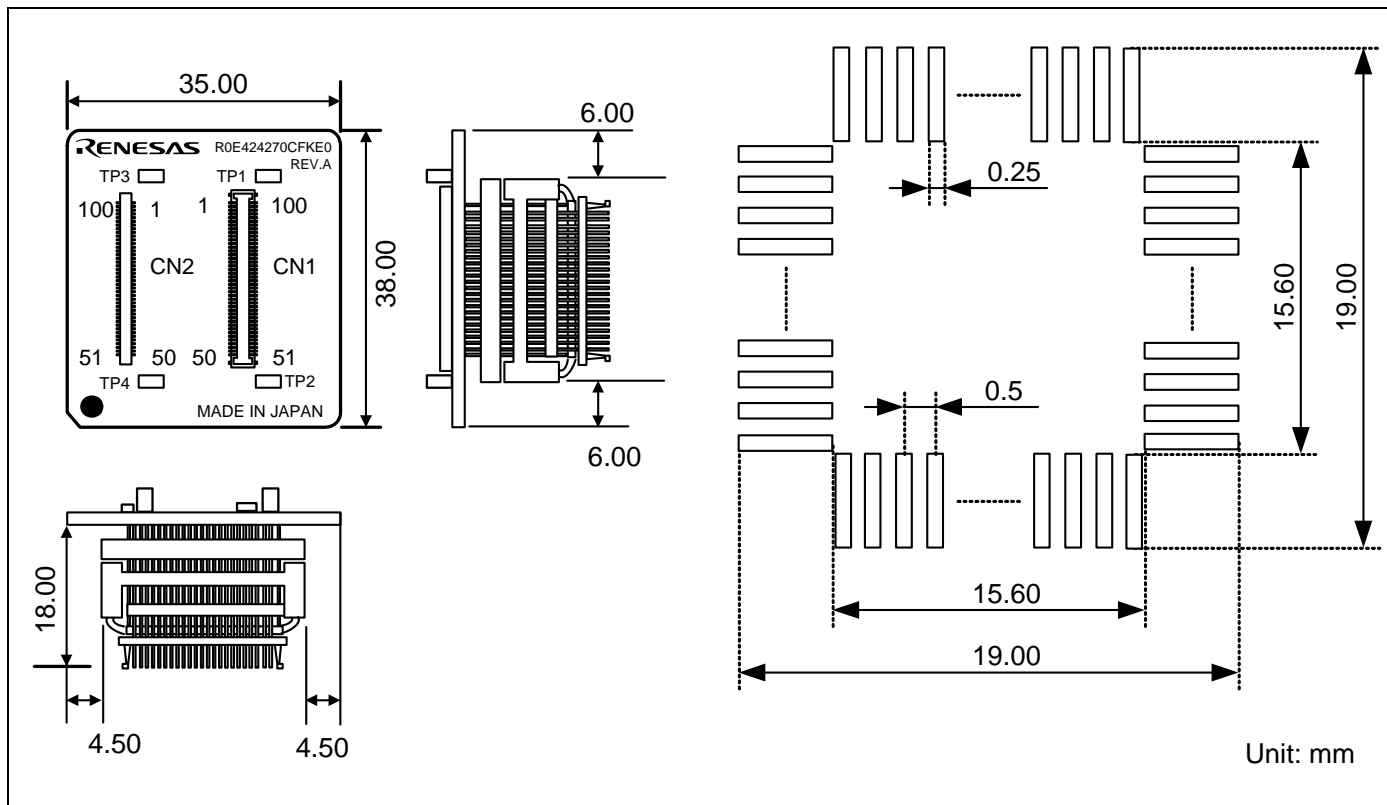

Figure 7.4 External dimensions and a sample pad pattern for the R0E424270CFKE0

7.4.4 External Dimensions of the Converter Board (R0E0144TNPFK00)

Figure 7.5 shows external dimensions and a sample pad pattern of the converter board (R0E0144TNPFK00) for a 64-pin 0.5-mm pitch LQFP.

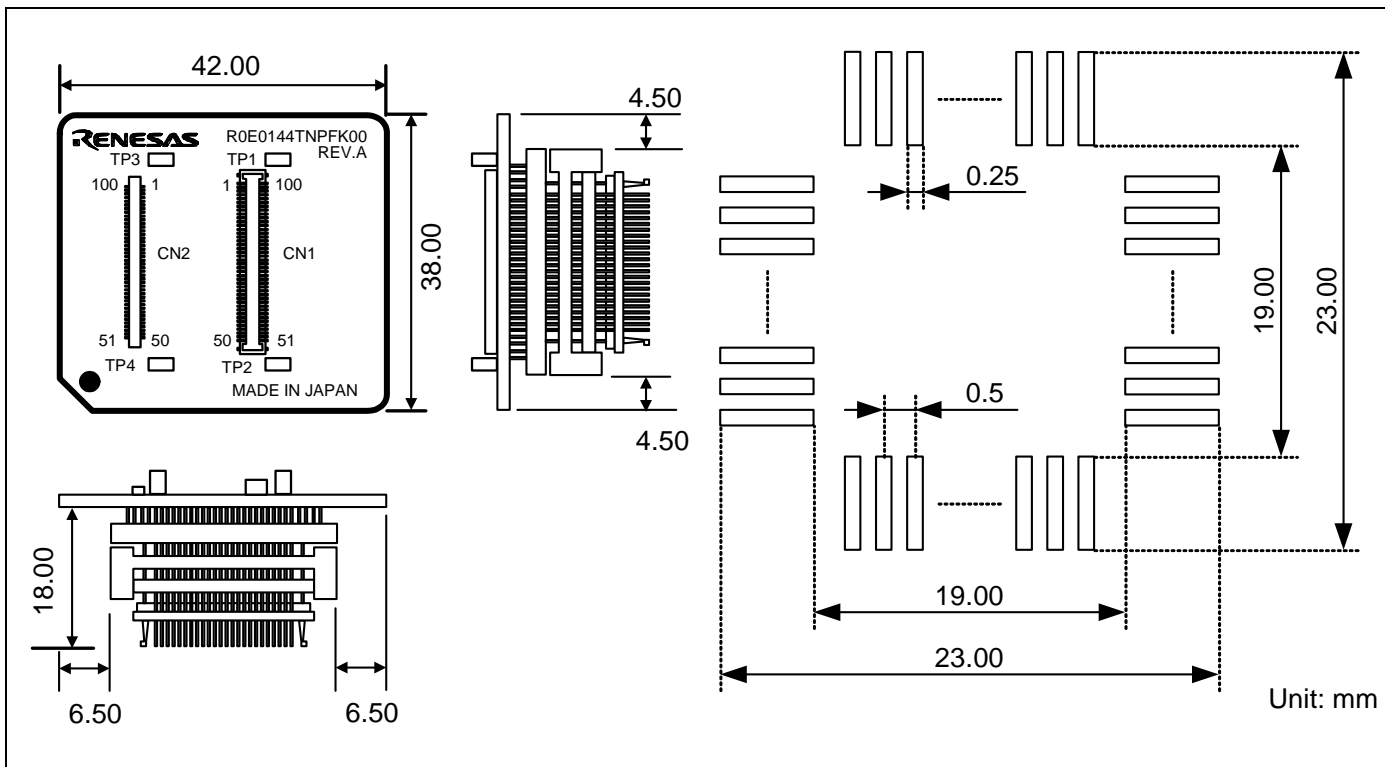

Figure 7.5 External dimensions and a sample pad pattern for the R0E0144TNPFK00

7.5 Notes on Using the MCU Unit

Notes on using the MCU unit are listed below. When using the MCU unit in debugging an application for the corresponding MCU, take care with regard to the following precautions.

IMPORTANT

Note on the Version of the Emulator Debugger:

- Be sure to use the MCU unit with the following emulator debugger.
 - H8S/Tiny H8S/2400 E100 Emulator Software V.2.00 Release 00 or later

Notes on Downloading Firmware:

- Before using the MCU unit for the first time, it is necessary to download the dedicated firmware (emulator's control software installed in the flash memory of the E100). If you need to download the firmware in booting-up of the emulator debugger, a message will appear. Download the firmware following the message.
- Do not shut off the power while downloading the firmware. If this happens, the product will not start up properly. If the power is shut off unexpectedly, re-download the firmware.
- Disconnect the MCU unit from the user system before you start downloading the firmware.

Notes on Self-checking:

- If the results of self-checking are not normal (excluding user system errors), the product may have been damaged. Contact your local distributor.
- Disconnect the MCU unit from the user system before you start self-checking.

Note on Quitting the Emulator Debugger:

- To restart the emulator debugger, always shut off the power supply to the emulator and then turn on it again.

Note on Display of MCU Status:

- The "Status" display you can view in the Connecting dialog box of the emulator debugger shows pin levels of the user system. Make sure that the pin levels required to select the mode you wish to use are correct.

Note on Clock Supply to the MCU:

- The source of the clock signal for supply to the evaluation MCU is selected on the System page of the Configuration properties dialog box of the emulator debugger.
 - (1) When "Emulator" is selected:

The supplied clock signal is that generated by the oscillator circuit board on the MCU unit. This is continually supplied regardless of the states of the user system clock and of user program execution.
 - (2) When "User" is selected:

The supplied clock signal is that generated by the oscillator in the user system. This depends on the state of oscillation (on/off) on the user system.
 - (3) When "Generate" is selected:

The supplied clock signal is that generated by the dedicated circuit in the E100. This is continually supplied regardless of the states of the user system clock and of user program execution.

IMPORTANT

Note on the Watchdog Function:

- If the reset circuit of the user system has a watchdog timer, disable the watchdog timer when using the emulator.

Note on Access Prohibited Area:

- You cannot use internally reserved areas. Write signals to these areas will be ignored, and values read will be undefined.

Note on Breaks:

- The following break functions are available in the emulator debugger.

(1) Software break

This is a debugging function which generates a BRK interrupt by changing the instruction at a specified address to a BRK instruction (a dedicated instruction for use with the emulator) to break program execution immediately before the system executes the instruction at a specified address. The instruction at the specified address will not be executed.

(2) Hardware break

This is a debugging function in which detecting the execution of the instruction at a specified address is set as a break event, and occurrence of the event leads to a break in program execution. The break in program execution comes after execution of the instruction at the specified address.

(3) Exceptional event

This is a debugging function in which a program is stopped when abnormal operation of the user program or an overflow of a measurement function's counter, etc. is detected.

Note on Software Breaks:

- After you have selected the "Debug the program with overwriting of flash memory" checkbox on the [System] page of the [Configuration properties] dialog box, the setting of software breakpoints in internal ROM becomes impossible. If you remove the tick from the "Debug the program with overwriting of flash memory" checkbox, setting such software breakpoints becomes possible.

IMPORTANT

Note on Transitions to Low-Power Consumption Modes:

- Generation of an interrupt while the emulator is in a low-power consumption mode causes the emulator to leave the low-power consumption mode. However, the emulator generates an emulation-only interrupt as part of processing in each of the following cases. Processing in each case will thus also lead to release from the low-power consumption mode.
 - (1) Forcible break (caused by pressing the Esc key or the Halt toolbar button)
 - (2) Break specified in an event detection system
 - (3) Single-stepping (Step In, Step Over, or Step Out)
 - (4) Execution of the program by selecting Go at the address of a SLEEP instruction for which a software break has been set

Notes on Power Supply to the User System:

- Pin Vcc is connected to the user system for monitoring of the voltage. Therefore, power is not supplied to the user system from the emulator. Design your system so that power is separately supplied to the user system.
- The voltage for the user system should be in the following range.
$$3.0\text{ V} \leq V_{cc} \leq 3.6\text{ V}, 4.5\text{ V} \leq V_{cc} \leq 5.5\text{ V}$$

Notes on Debugging with Overwriting of Flash Memory:

- If you wish to debug programs that include overwriting of flash memory, select the “Debug the program with overwriting of flash memory” checkbox on the [System] page of the [Configuration properties] dialog box.











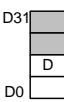

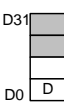
Restrictions on Debugging with Overwriting of Flash Memory:

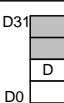
- If you select the “Debug the program with overwriting of flash memory” checkbox on the [System] page of the [Configuration properties] dialog box, the following operations will be disabled while the user program is running.
 - (1) Setting software breakpoints in an internal ROM area
 - (2) Programming in an internal ROM area

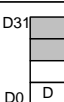
IMPORTANT

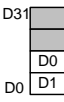
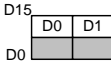
Data Bus in Trace Information:

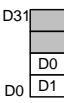
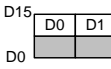
- Since the bus width within the emulator is 32 bits, if you have accessed an external space with a bus width of 8 bits, the trace information for the data bus may differ from the actual external bus operations of the MCU.

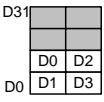
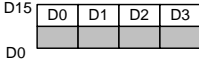
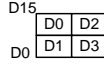
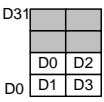
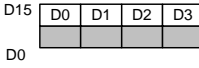
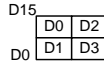
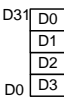
Access Unit	First Address	Bus Width in the Emulator	Bus Width in External Space	
		32 Bits	8 Bits	16 Bits
Byte	00			
	01			
	10			
	11			
Word	00			
	10			
Longword (other than DTCRAM)	00			
	10			
Longword (DTCRAM only)	00		No access to external space	

IMPORTANT

Trace Data after Transition from Self-Refresh to Software Standby Mode:

- When the MCU has made a transition from self-refresh to software standby mode and all of the conditions listed below are satisfied, the displayed realtime trace data will include some information that does not reflect actual operations if the user program is stopped (i.e. by a break due to an event or clicking on the [Stop] button).

[Conditions]

The above problem occurs when all of the following conditions are satisfied.

- (a) Bits TPCS2 to TPCS0 in the refresh control register (REFCR: H'FFFED4) were set to a value other than 000 while the MCU was in the self-refresh mode.
- (b) The MCU has entered the software standby mode.
- (c) A request to stop the program (i.e. by a break due to an event or clicking on the [Stop] button) was made in the software standby mode.

[Result]

Realtime trace information for at least ten cycles from the cycle of writing to address H'FFF964 until stopping of the user program will differ from the actual operation of the user program.

8. Maintenance and Warranty

This chapter covers basic maintenance, warranty information, provisions for repair and the procedures for requesting a repair.

8.1 User Registration

When you purchase our product, be sure to register as a user. For user registration, refer to "User Registration" (page 16) of this user's manual.

8.2 Maintenance

- (1) If dust or dirt collects anywhere on your emulation system, wipe it off with a dry soft cloth. Do not use thinner or other solvents because these chemicals can cause the equipment's surface coating to separate.
- (2) When you do not use the MCU unit for a long period, for safety purposes, disconnect the power cable from the power supply.

8.3 Warranty

If your product becomes faulty within one year after purchase while being used under conditions of observance of the "IMPORTANT" and "Precautions for Safety" notes in this user's manual, we will repair or replace your faulty product free of charge. Note, however, that if your product's fault is due to any of the following causes, an extra charge will apply to our repair or replacement of the product.

- Misuse, abuse, or use under extraordinary conditions
- Unauthorized repair, remodeling, maintenance, and so on
- Inadequate user system or improper use of the user system
- Fires, earthquakes, and other unexpected disasters

In the above cases, contact your local distributor. If your product is being leased, consult the leasing company or the owner.

8.4 Repair Provisions

(1) Repairs not covered by warranty

Problems arising in products for which more than one year has elapsed since purchase are not covered by warranty.

(2) Replacement not covered by warranty

If your product's fault falls into any of the following categories, the fault will be corrected by replacing the entire product instead of repairing it, or you will be advised to purchase a new product, depending on the severity of the fault.

- Faulty or broken mechanical portions
- Flaws, separation, or rust in coated or plated portions
- Flaws or cracks in plastic portions
- Faults or breakage caused by improper use or unauthorized repair or modification
- Heavily damaged electric circuits due to overvoltage, overcurrent or shorting of power supply
- Cracks in the printed circuit board or burnt-down patterns
- A wide range of faults that make replacement less expensive than repair
- Faults that are not locatable or identifiable

(3) Expiration of the repair period

When a period of one year has elapsed after production of a given model ceased, repairing products of that model may become impossible.

(4) Carriage fees for sending your product to be repaired

Carriage fees for sending your product to us for repair are at your own expense.

8.5 How to Request Repairs

If your product is found faulty, fill in a Repair Request Sheet downloadable from the following URL. And email the sheet and send the product to your local distributor.

<https://www.renesas.com/repair>

CAUTION

Note on Transporting the Product:



- When sending your product for repair, use the packing box and cushioning material supplied with the MCU unit when it was delivered to you and specify caution in handling (handling as precision equipment). If packing of your product is not complete, it may be damaged during transportation. When you pack your product in a bag, make sure to use the conductive plastic bag supplied with the MCU unit (usually a blue bag). If you use a different bag, it may lead to further trouble with your product due to static electricity.

Revision History

Rev.	Date	Description	
		Page	Summary
2.01	Dec.01.15	3	Regulatory Compliance Notices changed
2.02	Sep.01.21	—	The statement of inclusion of an AC adapter was removed.
		4	Regulatory Compliance Notices was changed.
		24	The specifications of the AC adapter were added.

E100 Emulator Main Unit for H8S/2400 Series
User's Manual
R0E424270MCU00

Publication Date: Sep.01.21 Rev.2.02

Published by: Renesas Electronics Corporation
