

50 Ω

DC – 26 GHz

I

NEW SERIES

- SMA solderless connectors for semi-rigid cable
- SMA 2.9 DC – 46 GHz

GENERAL

- Miniature coaxial connectors
 - Screw-on coupling
 - High RF performance
 - 2 plating options :
 - gold plated
 - passived stainless steel
- Space qualified range of products.

APPLICABLE STANDARDS

- MIL-C-39012
- IEC 169-1
- CECC 22110
- BS 9210 N 0006

QUALIFICATIONS / APPROVALS

- BS 9210 N 0006
- CECC 22110
- QPL MIL-C-39012



SPACE QUALIFIED APPROVALS

- SCC 3402 (ESA)



APPLICATIONS

- Civil & Military Telecommunication
- Civil & Military Aeronautics
- Military equipments
- Space

CONTENTS

General	I 3
Characteristics	I 4-6
Interface	I 7
Plugs & Jacks	I 8-13
Receptacles	I 14-27
In series adapters	I 28-29
Caps & Cabling tool kit	I 30
Hermetic separate glass bead receptacles	I 31-32
Accessories	I 32
Screw on receptacles	I 33
Panel drilling	I 33
Mounting instructions	I 34-44
Stripline installation	I 45-46
QPL-MIL/Radiall cross ref. list	I 47

CHARACTERISTICS

REQUIREMENT	MIL - C - 39012 paragraph	GENERAL SPECIFICATIONS																
ELECTRICAL																		
Impedance		50 Ω																
Frequency range		0 - 26 GHz																
V.S.W.R. up to 18 GHz	3 - 14	<table border="0"> <tr> <td>Cable</td> <td>Straight</td> <td>Right angle</td> </tr> <tr> <td>2,6/50</td> <td>1,15 +0,02 F (GHz)</td> <td>1,15 +0,03 F (GHz)</td> </tr> <tr> <td>5/50</td> <td>1,15 +0,01 F (GHz)</td> <td>1,157 +0,02 F (GHz)</td> </tr> <tr> <td>.085"</td> <td>1,07 +0,01 F (GHz)</td> <td>1,10 +0,01 F (GHz)</td> </tr> <tr> <td>.141"</td> <td>1,05 +0,01 F (GHz)</td> <td>1,10 +0,01 F (GHz)</td> </tr> </table>	Cable	Straight	Right angle	2,6/50	1,15 +0,02 F (GHz)	1,15 +0,03 F (GHz)	5/50	1,15 +0,01 F (GHz)	1,157 +0,02 F (GHz)	.085"	1,07 +0,01 F (GHz)	1,10 +0,01 F (GHz)	.141"	1,05 +0,01 F (GHz)	1,10 +0,01 F (GHz)	
Cable	Straight	Right angle																
2,6/50	1,15 +0,02 F (GHz)	1,15 +0,03 F (GHz)																
5/50	1,15 +0,01 F (GHz)	1,157 +0,02 F (GHz)																
.085"	1,07 +0,01 F (GHz)	1,10 +0,01 F (GHz)																
.141"	1,05 +0,01 F (GHz)	1,10 +0,01 F (GHz)																
Insertion loss	3 - 27	straight : 0,03 \sqrt{f} (GHz) right angle : 0,05 \sqrt{f} (GHz)																
RF leakage	3 - 26	- 60 dB min. between 2 and 3 GHz																
Insulation resistance	3 - 11	5000 megohms min.																
Contact resistance	3 - 16	<table border="1"> <thead> <tr> <th></th> <th>Initial</th> <th>After environment</th> </tr> </thead> <tbody> <tr> <td>Center contact (mΩ)</td> <td>3</td> <td>4</td> </tr> <tr> <td>Outer contact (mΩ)</td> <td>2,5</td> <td>3</td> </tr> </tbody> </table>		Initial	After environment	Center contact (m Ω)	3	4	Outer contact (m Ω)	2,5	3							
	Initial	After environment																
Center contact (m Ω)	3	4																
Outer contact (m Ω)	2,5	3																
Voltage rating (volts RMS)		<table border="0"> <tr> <td>Cable 2,6/50 : at sea level</td> <td>250 V,</td> <td>at 70000 ft (21000 m)</td> <td>85 V</td> </tr> <tr> <td>5/50 :</td> <td>335 V,</td> <td></td> <td>125 V</td> </tr> <tr> <td>.085" :</td> <td>350 V,</td> <td></td> <td>85 V</td> </tr> <tr> <td>.141" :</td> <td>500 V,</td> <td></td> <td>125 V</td> </tr> </table>	Cable 2,6/50 : at sea level	250 V,	at 70000 ft (21000 m)	85 V	5/50 :	335 V,		125 V	.085" :	350 V,		85 V	.141" :	500 V,		125 V
Cable 2,6/50 : at sea level	250 V,	at 70000 ft (21000 m)	85 V															
5/50 :	335 V,		125 V															
.085" :	350 V,		85 V															
.141" :	500 V,		125 V															
Dielectric withstanding voltage	3 - 17	<table border="0"> <tr> <td>Cable 2,6/50 : at sea level</td> <td>750 V,</td> <td>at 70000 ft (21000m)</td> <td>185 V</td> </tr> <tr> <td>5/50 :</td> <td>1000 V,</td> <td></td> <td>250 V</td> </tr> <tr> <td>.085" :</td> <td>1000 V,</td> <td></td> <td>250 V</td> </tr> <tr> <td>.141" :</td> <td>1500 V,</td> <td></td> <td>375 V</td> </tr> </table>	Cable 2,6/50 : at sea level	750 V,	at 70000 ft (21000m)	185 V	5/50 :	1000 V,		250 V	.085" :	1000 V,		250 V	.141" :	1500 V,		375 V
Cable 2,6/50 : at sea level	750 V,	at 70000 ft (21000m)	185 V															
5/50 :	1000 V,		250 V															
.085" :	1000 V,		250 V															
.141" :	1500 V,		375 V															
RF high potential withstanding voltage (Frequency 5 MHz)	3 - 23	<table border="0"> <tr> <td>Cable 2,6/50 : at sea level</td> <td>500 V</td> </tr> <tr> <td>5/50 :</td> <td>670 V</td> </tr> <tr> <td>.085" :</td> <td>670 V</td> </tr> <tr> <td>.141" :</td> <td>1000 V</td> </tr> </table>	Cable 2,6/50 : at sea level	500 V	5/50 :	670 V	.085" :	670 V	.141" :	1000 V								
Cable 2,6/50 : at sea level	500 V																	
5/50 :	670 V																	
.085" :	670 V																	
.141" :	1000 V																	
Peak power		20 kW (1 μ s)																
Average power		see opposite																
MECHANICAL																		
Life	3 - 15	500 matings																
Force to engage and disengage	3 - 5 - 1	torque : 2 inch-pounds - 23 N.cm																
Mating torque		7 to 10 inch-pounds - 80 to 115 N.cm																
Coupling nut proof torque		.15 inch-pounds - 170 N.cm																
Coupling nut retention force	3 - 25	60 lbf - 267 N																
Cable retention force	3 - 24	2,6/50 cable : 25 lbs - 110 N, 5/50 cable : 40 lbs-180 N .085" cable : 30 lbs - 133 N, .141" cable : 60 lbs-270 N																
Contact captivation		axial force : 6 lbf - 27 N torque : 4 inch-ounces - 2,8 N. cm																
ENVIRONMENTAL																		
Operating temperature range		standard models : - 65°C + 165°C hermetic : - 65°C + 165°C except R 125 603 and R 125 753 : - 40°C + 100°C semi-rigid cables : - 65°C + 105°C																
Temperature cycling		MIL-STD-202, method 102, condition C																
Thermal shock	3 - 20	MIL-STD-202, method 107, condition B																
High temperature test		MIL-STD-202, method 108																
Corrosion (salt spray)	3 - 13	MIL-STD-202, method 101, condition B, 5%																
Vibration	3 - 18	MIL-STD-202, method 204, condition D, 20 g																
Shock	3 - 19	MIL-STD-202, method 213, condition I, 100 g																
Moisture resistance	3 - 21	MIL-STD-202, method 106																
Barometric pressure	3 - 22	MIL-STD-202, method 105, condition C																
Hermetic test		down to 10 ⁻⁶ mm Hg (Torr) leak rate <10 ⁻⁸ atm/cm ³ /sec.																

Items in this catalog covered by French and Foreign Patents and/or Patents Pending



MATERIALS

Bodies
 Female contacts
 Male contacts
 Insulators
 Gaskets

Beryllium copper or stainless steel
 Beryllium copper
 Brass
 PTFE teflon
 Silicone rubber

PLATING

Bodies
 Center contacts

Gold plated or passivated
 Gold plated

COEFFICIENT OF CORRECTION

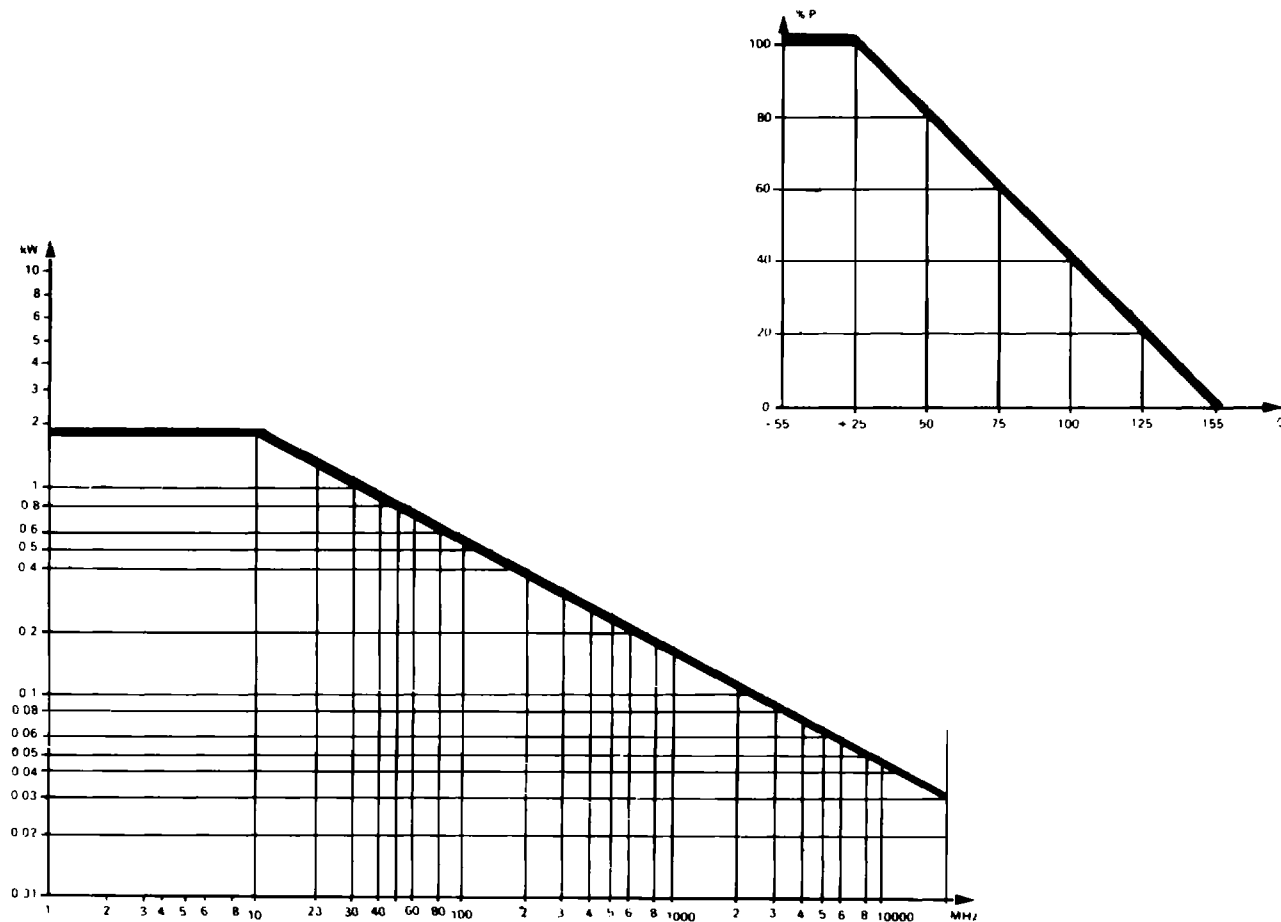

AVERAGE POWER HANDLING (VSWR in line : 1)

SMA

CHARACTERISTICS

V.S.W.R. AND FACTOR OF REFLECTION CURVES

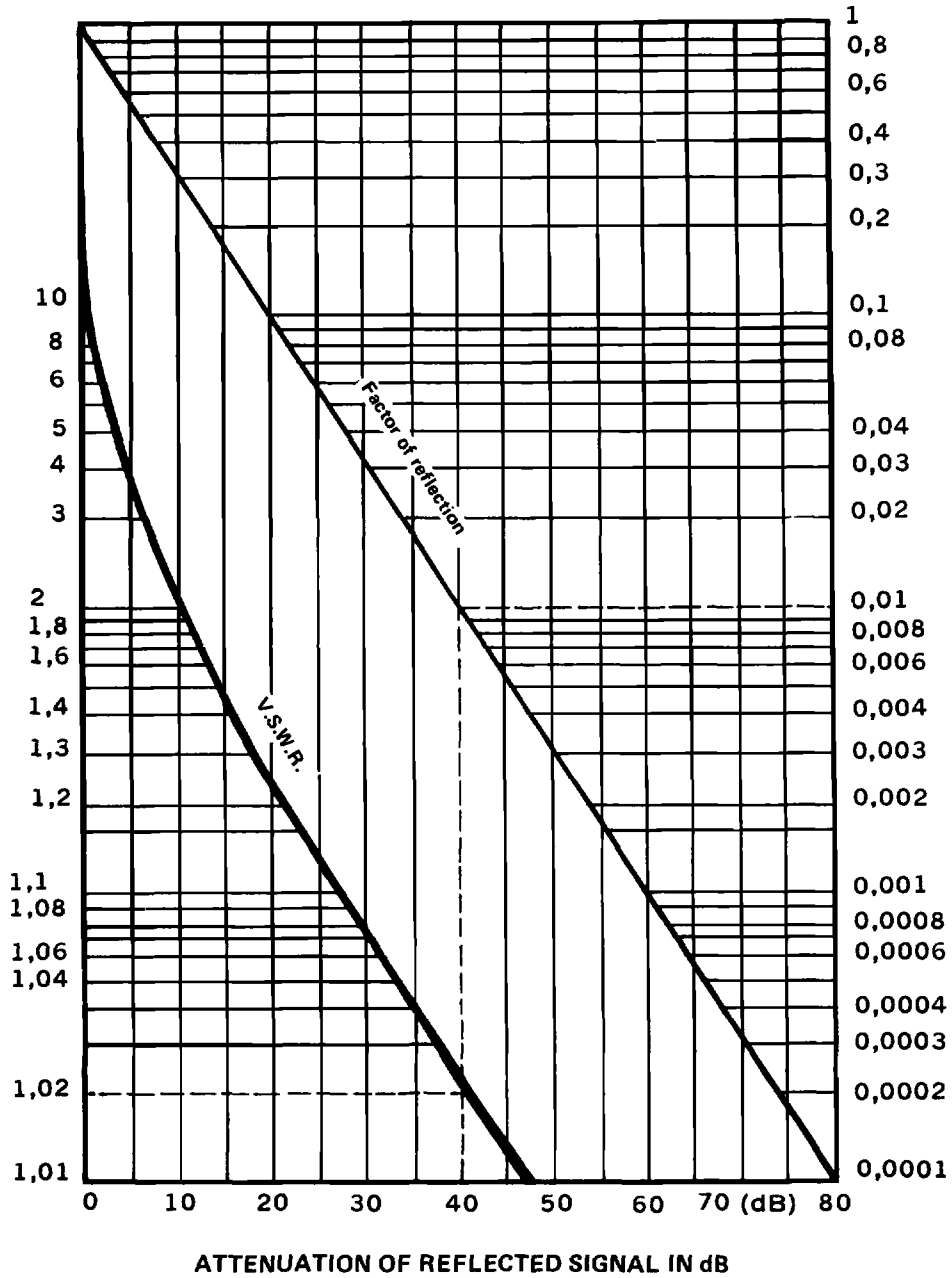

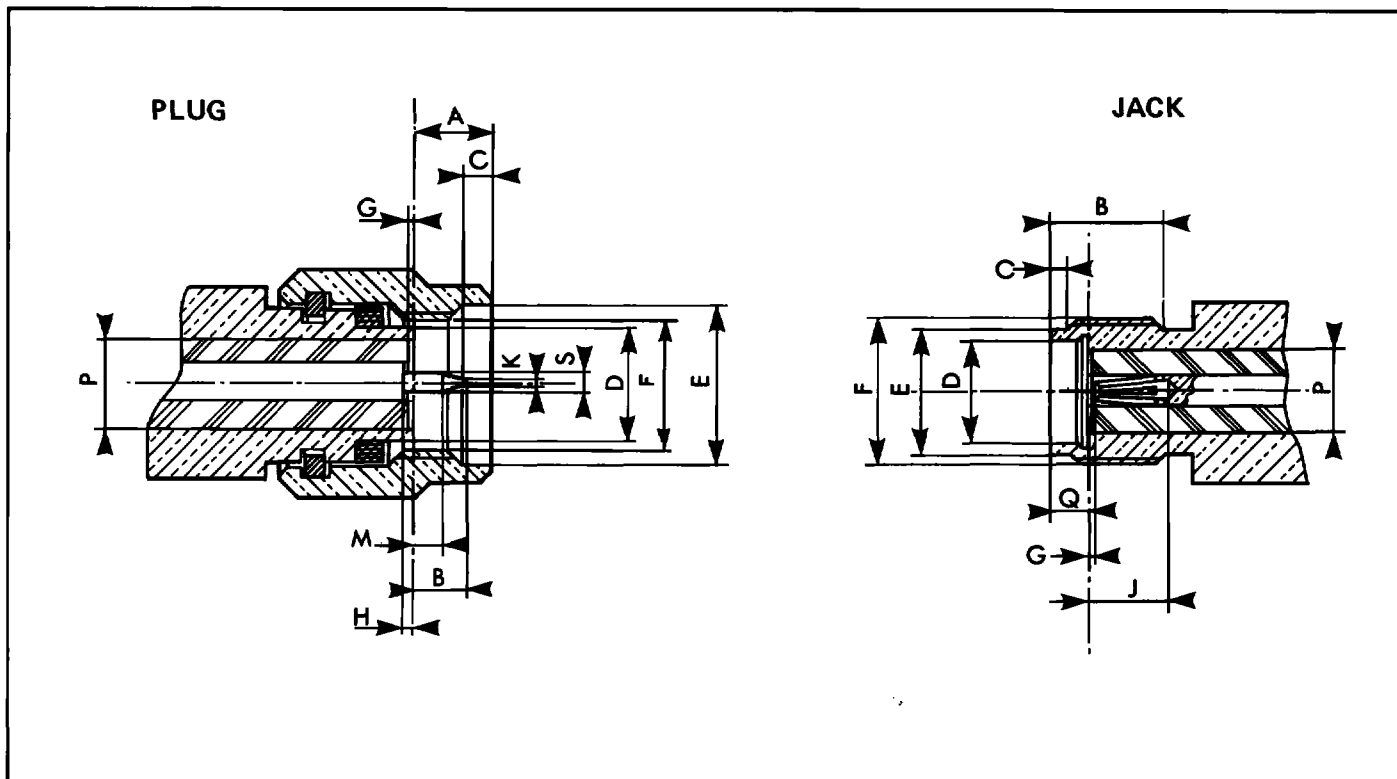

Letter	PLUG				JACK			
	mm		Inch		mm		Inch	
	min.	max.	min.	max.	min.	max.	min.	max.
A		3,43		.135				
B		2,54		.100	4,31		.170	
C	0,38	1,14	.015	.045	0,38	1,14	.015	.045
ØD		4,59		.1808	4,596		.1810	
ØE	6,35		.250		5,28	5,49	.208	.216
F	N° 10 36 UNS 2 B				N° 10 36 UNS 2 A			
G		0,05		.002	0,00	0,76	0,00	.030

Letter	PLUG				JACK			
	mm		Inch		mm		Inch	
	min.	max.	min.	max.	min.	max.	min.	max.
H	0,00	0,25	0,00	.010				
J					2,92		.115	
ØK		0,38		.015				
M	1,27			.050				
Q					1,88	1,98	.074	.078
ØS	0,90	0,94	.035	.037				
P	4,10 nom.		.161 nom.		4,10 nom.		.161 nom.	

SMA

FOR FLEXIBLE CABLE, CABLE CLAMP TYPE

STRAIGHT PLUG CAPTIVE CONTACT

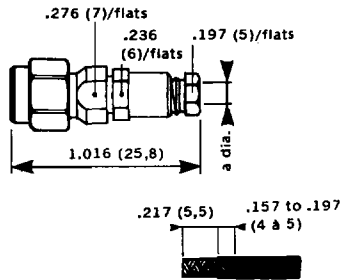
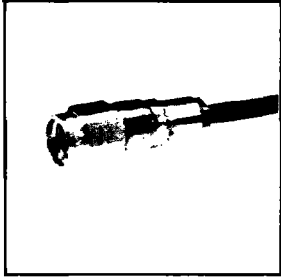

CABLE RG	174 A/U - 188 A/U
PART NUMBER	R 125 091
MIL no.	55-4107
a dia.	.118 (3)
Assembly	M 05

(For passivated stainless steel version, add suffix 001)

FOR FLEXIBLE CABLE, CRIMP OR SOLDER TYPE

STRAIGHT PLUG CAPTIVE CONTACT

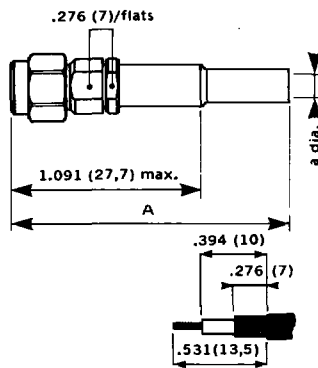
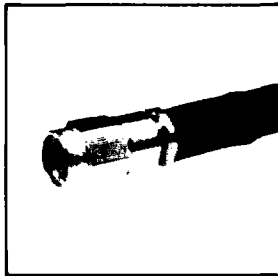

CABLE RG	174 A/U 188 A/U	180 B/U 195 A/U	58 C/U 141 A/U 303/U	142 B/U 223/U 400/U
PART NUMBER	R 125 073	R 125 074	R 125 077	R 125 078
MIL no.	55-3119		55-3121	55-3122
a dia.	.128 (3,25)	.181 (4,6)	.217 (5,5)	.217 (5,5)
Dim. A	1,457 (37)	1,594 (40,5)	1,594 (40,5)	1,594 (40,5)
Assembly	M 03	M 03	M 03	M 03

(For passivated stainless steel version, add suffix 001, crimp only)

STRAIGHT PLUG NON CAPTIVE CONTACT

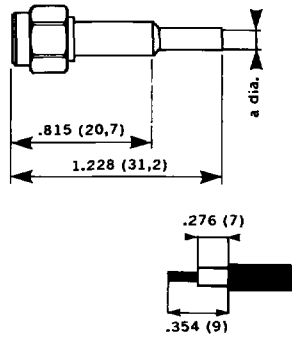
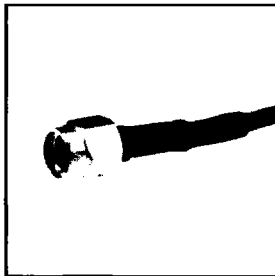

CABLE RG	174 A/U - 188 A/U	RD 316
PART NUMBER	R 125 072 *	R 125 072 008
MIL no.	55-3112	
a dia.	.128 (3,25)	.138 (3,5)
Assembly	M 01	M 01

* (For passivated stainless steel version, add suffix 001, crimp only)

STRAIGHT PLUG NON CAPTIVE CONTACT

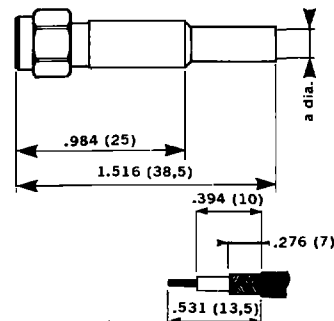
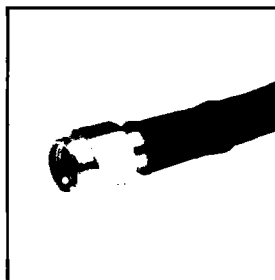

CABLE RG	58 C/U 141 A/U 303 /U	142 B/U 223 /U 400 /U
PART NUMBER	R 125 075	R 125 076
MIL no.	55-3114	55-3115
a dia.	.217 (5,5)	.217 (5,5)
Assembly	M 01	M 01

(For passivated stainless steel version, add suffix 001, crimp only)

SMA

FOR FLEXIBLE CABLE, CRIMP OR SOLDER TYPE

CABLE RG	174 A/U - 188 A/U
PART NUMBER	R 125 172
MIL no.	56-3119
a dia.	.128 (3,25)
Assembly	M 04

(For passivated stainless steel version, add suffix 001, crimp only)

RIGHT ANGLE PLUG

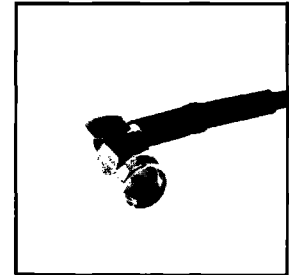
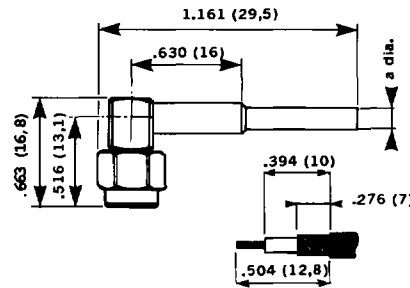

CABLE RG	58 C/U 141 A/U 303/U	142 B/U 223/U 400/U
PART NUMBER	R 125 175	R 125 176
MIL no.	56-3121	56-3122
a dia.	.217 (5,5)	.217 (5,5)
Assembly	M 04	M 04

(For passivated stainless steel version, add suffix 001, crimp only)

RIGHT ANGLE PLUG

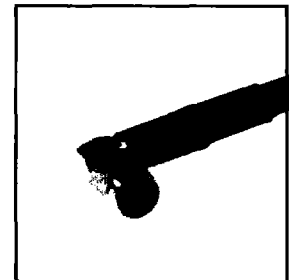
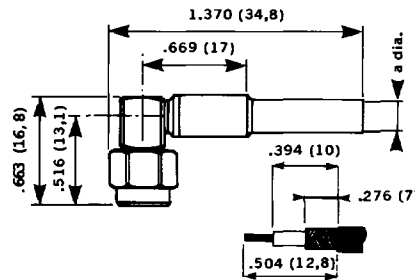

The references quoted as MIL or BS numbers are the style numbers covered by a specification sheet within the generic spec.

e.g. R 125 172 R 125 176
MIL - C - 39012 BS 9210
M 39012/56 - 4119 F 0017/08.02 AK

EVOLUTION OF THE SMA SERIES

Regular efforts from our R and D department to improve our products today enable us to mount operating frequency of the 18 GHz SMA connectors up to 26 GHz.

SMA

FOR FLEXIBLE CABLE, CRIMP TYPE

STRAIGHT JACK

CAPTIVE CONTACT

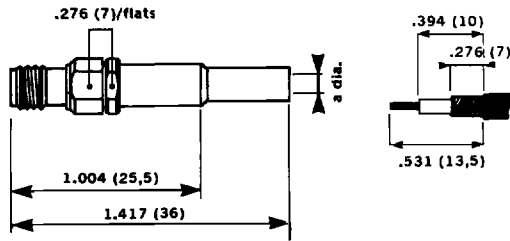
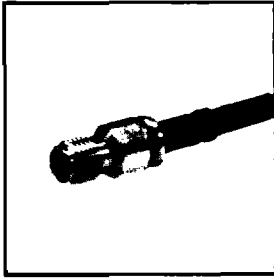

CABLE RG	174 A/U - 188 A/U	
PART NUMBER	R 125 236	
MIL no.	57 - 4019	
a dia.	.128 (3,25)	
Assembly	M 03	

(For passivated stainless steel version, add suffix 001, crimp only)

FOR FLEXIBLE CABLE, CRIMP OR SOLDER TYPE

STRAIGHT JACK

NON CAPTIVE CONTACT

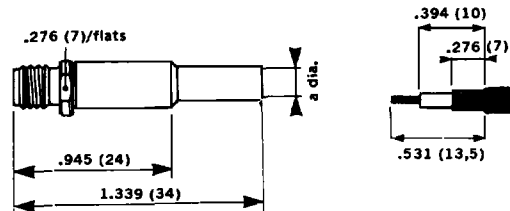
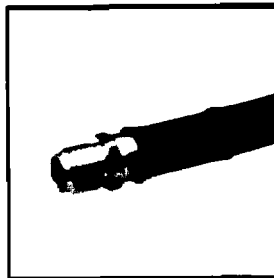

CABLE RG	58 C/U 141 A/U 303 /U	142 B/U 223 /U 400 /U
PART NUMBER	R 125 237	R 125 238
MIL no.	57-4014	57-4015
a dia	.217 (5,5)	.217 (5,5)
Assembly	M 01	M 01

(For passivated stainless steel version, add suffix 001, crimp only)

SQUARE FLANGE JACK

CAPTIVE CONTACT

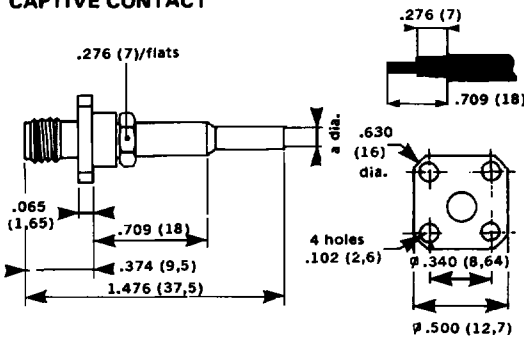
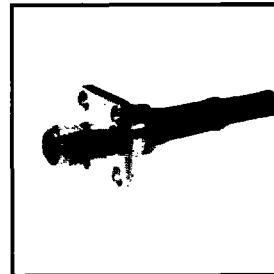

CABLE RG	174 A/U - 188 A/U	
PART NUMBER	R 125 272	
MIL no.	58 - 4012	
a dia.	.128 (3,25)	
Assembly	M 02	

(For passivated stainless steel version, add suffix 001, crimp only)

BULKHEAD JACK

CAPTIVE CONTACT

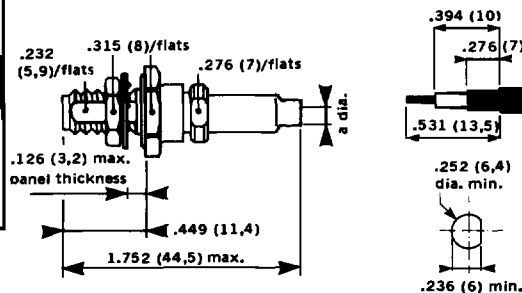
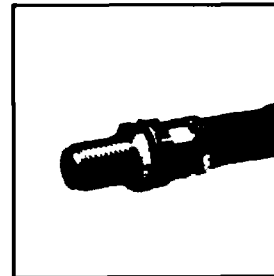

CABLE RG	174 A/U - 188 A/U	142 B/U 223/U 400/U
PART NUMBER	R 125 303	R 125 308
a dia.	.128 (3,25)	.217 (5,5)
Assembly	M 03	M 03

(For passivated stainless steel version, add suffix 001, crimp only)

FOR SEMI RIGID CABLE, DIRECT SOLDER TYPE

CABLE Ø	.085"	.141"
PART NUMBER	R 125 052	R 125 055
MIL no.	79-3101	79-3102
a dia.	.089 (2,25)	.144 (3,65)
Assembly	M 09	M 09

(For passivated stainless steel version with gold plated part to be soldered for cable attachment, add suffix 002)

STRAIGHT PLUG (WITH CENTER CONTACT)

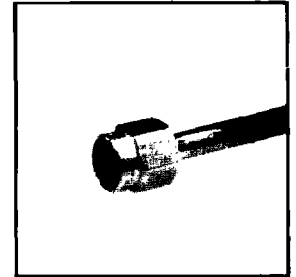
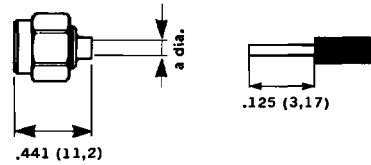

CABLE Ø	.141"
PART NUMBER	R 125 054
MIL no.	92-3101
a dia.	.144 (3,65)
Assembly	M 08

(For passivated stainless steel version with gold plated part to be soldered for cable attachment, add suffix 002)

STRAIGHT PLUG (WITHOUT CENTER CONTACT)

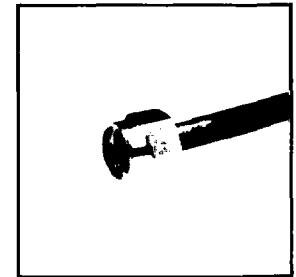
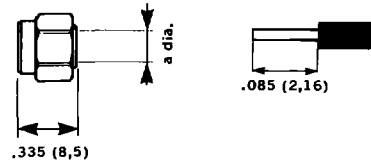

CABLE Ø	.141"
PART NUMBER	R 125 057
MIL no.	92-4101
a dia.	.144 (3,65)
Assembly	M 08

(For passivated stainless steel version with gold plated part to be soldered for cable attachment, add suffix 002)

STRAIGHT PLUG (WITHOUT CENTER CONTACT)

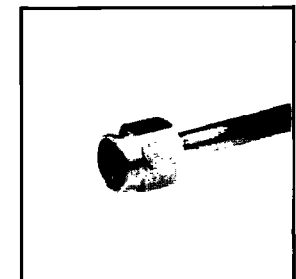
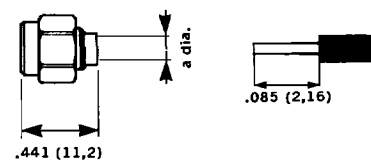

FOR SEMI-RIGID CABLE, COMPRESSION TYPE

STRAIGHT PLUG

CABLE Ø	.250"
PART NUMBER	R 125 056
a dia.	.260 (6,6)
Assembly	M 12

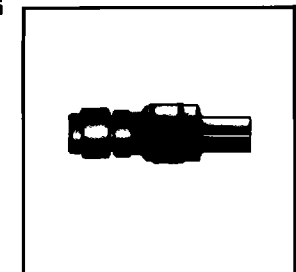
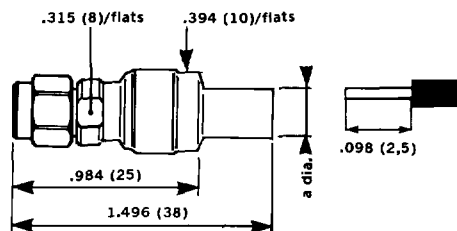

For passivated stainless steel version, add suffix 001.

SMA

FOR SEMI RIGID CABLE, DIRECT SOLDER TYPE

STRAIGHT PLUG WITH RETRACTABLE COUPLING NUT (WITH CENTER CONTACT)

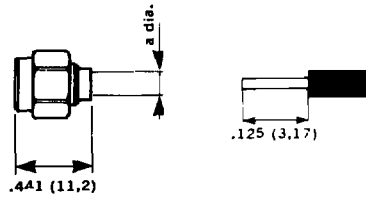
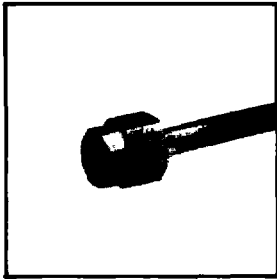

CABLE Ø	.085"	.141"
PART NUMBER	R 125 052 500	R 125 055 500
a dia.	.089 (2,25)	.144 (3,65)
Assembly	M 09	M 09

STRAIGHT PLUG WITH RETRACTABLE COUPLING NUT

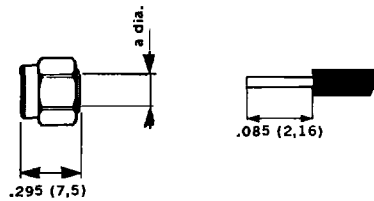
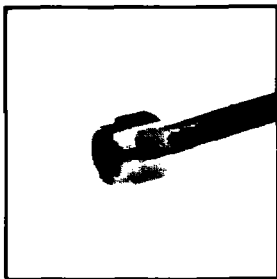

CABLE Ø	.141"
PART NUMBER	R 125 054 500
a dia.	.144 (3,65)
Assembly	M 07

RIGHT ANGLE PLUG

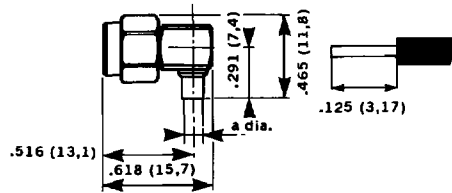
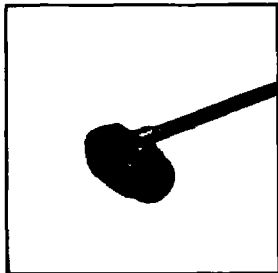

CABLE Ø	.085"	.141"
PART NUMBER	R 125 153	R 125 154
MIL no.	80-3107	80-3108
a dia.	.089 (2,25)	.144 (3,65)
Assembly	M 10	M 10

(For passivated stainless steel version with gold plated part to be soldered for cable attachment, add suffix 002)

FOR SEMI-RIGID CABLE, COMPRESSION TYPE

STRAIGHT JACK

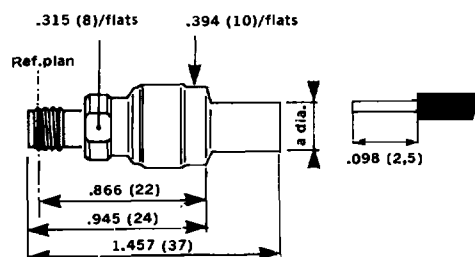
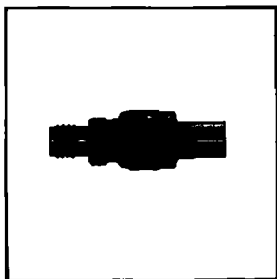

CABLE Ø	.250"
PART NUMBER	R 125 226
a dia.	.254 (6,45)
Assembly	M 12

CABLE Ø	.085"	.141"
PART NUMBER	R 125 222	R 125 225
MIL no.	81-3005	81-3006
a dia.	.089 (2,25)	.144 (3,65)
Assembly	M 11	M 11

(For passivated stainless steel version, add suffix 001)

STRAIGHT JACK

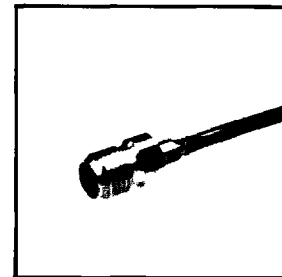
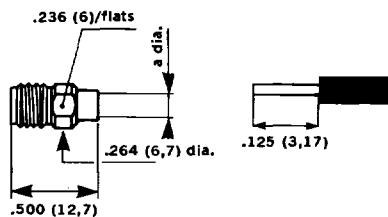

CABLE Ø	.085"	.141"
PART NUMBER	R 125 256	R 125 255
MIL no.	82-3005	82-3006
a dia.	.089 (2,25)	.144 (3,65)
Assembly	M 11	M 11

(For passivated stainless steel version, add suffix 001)

SQUARE FLANGE JACK

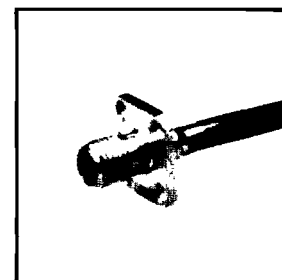
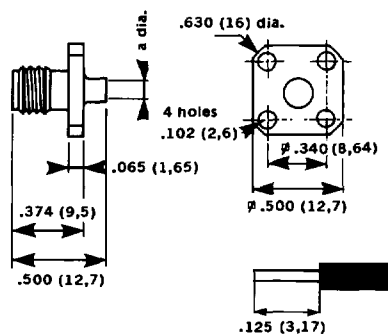

CABLE Ø	.085"	.141"
PART NUMBER	R 125 252	R 125 251
a dia.	.089 (2,25)	.144 (3,65)
Assembly	M 11	M 11

(For passivated stainless steel version, add suffix 001)

NARROW FLANGE JACK

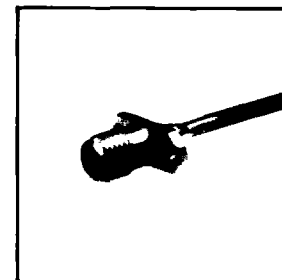
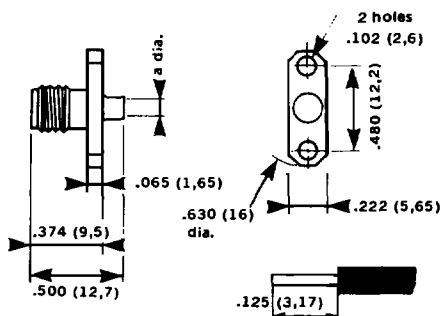

CABLE Ø	.085"	.141"
PART NUMBER	R 125 326	R 125 325
a dia.	.089 (2,25)	.144 (3,65)
Assembly	M 11	M 11

(For passivated stainless steel version, add suffix 001)

BULKHEAD JACK (PANEL SEAL)

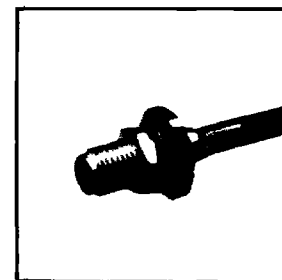
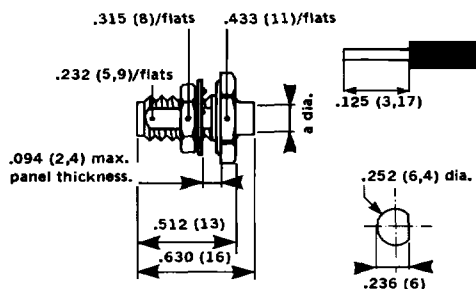

SQUARE FLANGE RECEPTACLE

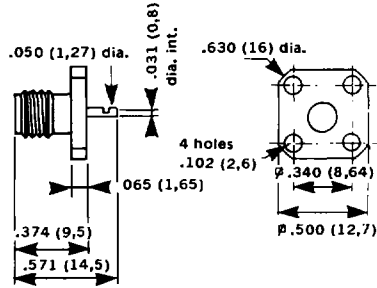
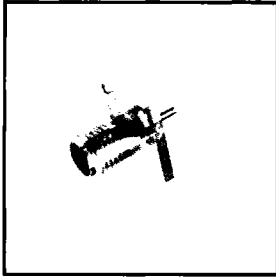

PART NUMBER	R 125 403
Captive contact	YES
MIL no.	60 - 4001

(For passivated stainless steel version, add suffix 001)

SQUARE FLANGE MALE RECEPTACLE

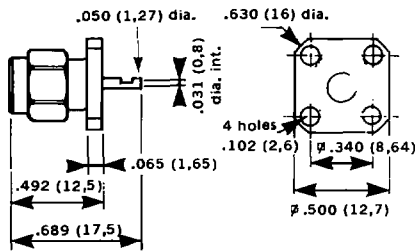
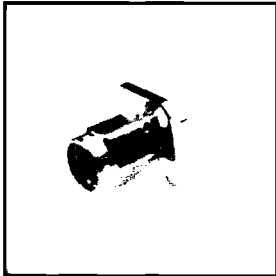

PART NUMBER	R 125 433
Captive contact	YES

(For passivated stainless steel version, add suffix 001)

NARROW FLANGE RECEPTACLE

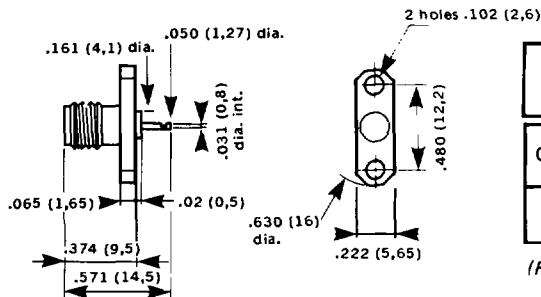
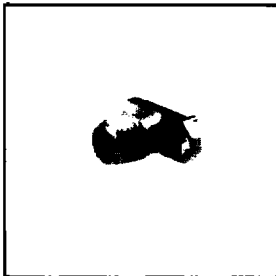

PART NUMBER	R 125 453
Captive contact	YES
MIL no.	60 - 4002

(For passivated stainless steel version, add suffix 001)

NARROW FLANGE RECEPTACLE

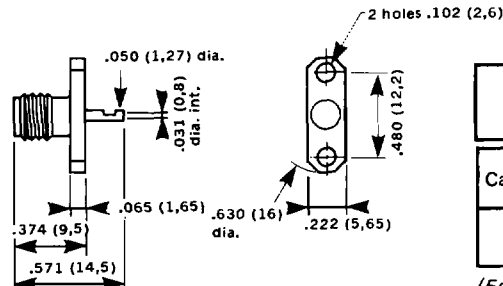
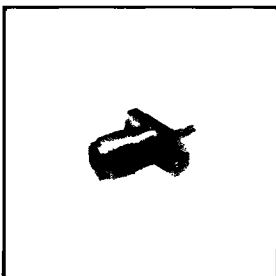

PART NUMBER	R 125 454
Captive contact	YES
MIL no.	60 - 4002

(For passivated stainless steel version, add suffix 001)

NARROW FLANGE MALE RECEPTACLE

PART NUMBER	R 125 483
Captive contact	YES

(For passivated stainless steel version, add suffix 001)

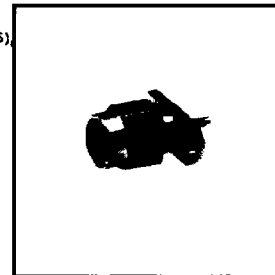
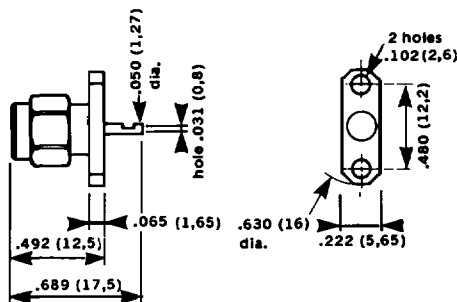

RIGHT ANGLE SQUARE FLANGE RECEPTACLE

PART NUMBER	R 125 653
-------------	-----------

(For passivated stainless steel version, add suffix 001)

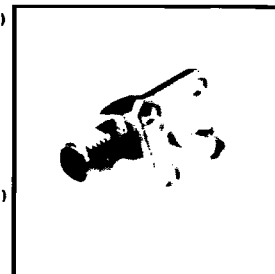
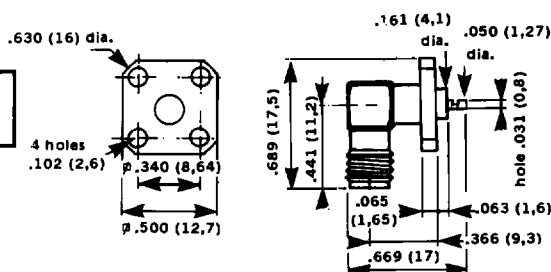

RIGHT ANGLE SQUARE FLANGE RECEPTACLE

PART NUMBER	R 125 654
-------------	-----------

(For passivated stainless steel version, add suffix 001)

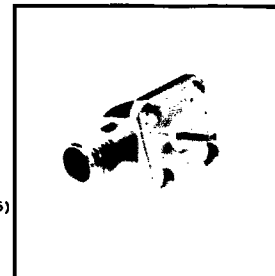
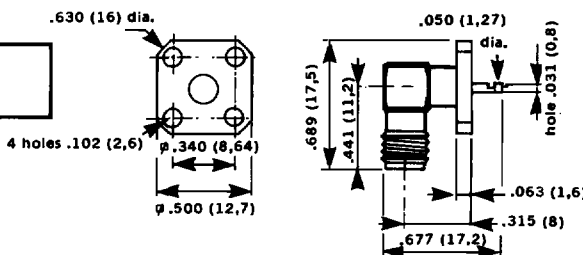

BULKHEAD RECEPTACLE

PART NUMBER	R 125 553
Captive contact	YES

(For passivated stainless steel version, add suffix 001)

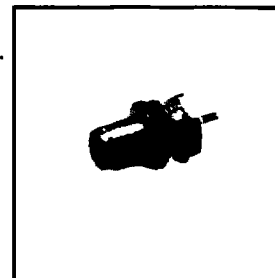
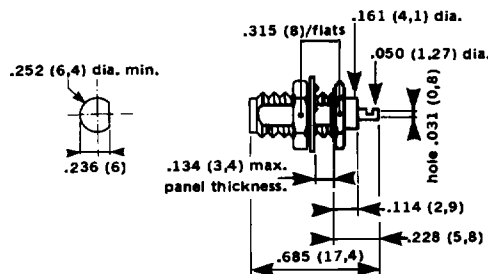

SMA

RECEPTACLES WITH EXTENDED DIELECTRIC-STUB CONTACT

SQUARE FLANGE RECEPTACLE

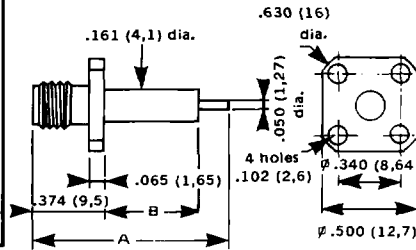

PART NUMBER	R 125 413	R 125 414	R 125 415	R 125 415 270
Captive contact	NO	YES	YES	YES
Dim. A	1.000 (25,4)	1.000 (25,4)	1.181 (30)	1.079 (27,4)
Dim. B	.500 (12,7)	.500 (12,7)	.709 (18)	.591 (15)

(For passivated stainless steel version, add suffix 001, except R 125 415 270 which becomes R 125 415 271.)

SQUARE FLANGE MALE RECEPTACLE

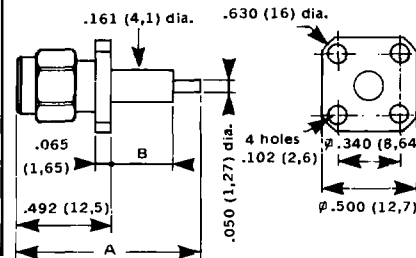

PART NUMBER	R 125 443	R 125 444	R 125 449
Captive contact	NO	YES	YES
Dim. A	.984 (25)	.984 (25)	1.752 (44,5)
Dim. B	.335 (8,5)	.335 (8,5)	1.122 (28,5)

(For passivated stainless steel version, add suffix 001)

NARROW FLANGE RECEPTACLE

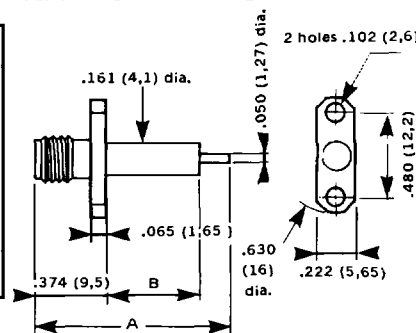
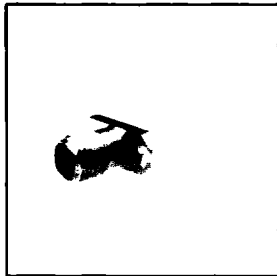

PART NUMBER	R 125 464	R 125 464 270
Captive contact	YES	YES
Dim. A	1.000 (25,4)	1.079 (27,4)
Dim. B	.500 (12,7)	.591 (15)

(Passivated stainless steel versions : R 125 464 001 and R 125 464 271)

NARROW FLANGE MALE RECEPTACLE

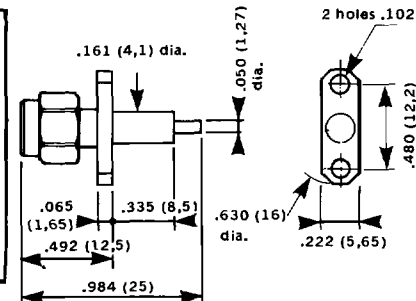
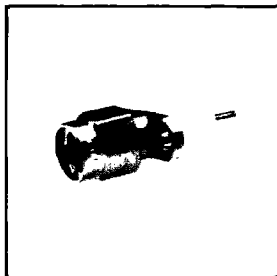

PART NUMBER	R 125 474
Captive contact	YES

(For passivated stainless steel version, add suffix 001)

RECEPTACLES WITH EXTENDED DIELECTRIC-STUB CONTACT

BULKHEAD RECEPTACLE - SCREW IN

PART NUMBER	R 125 555 500
Captive contact	YES

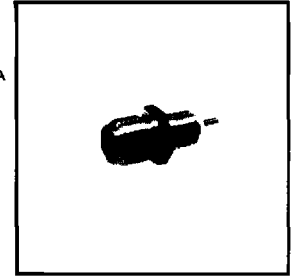
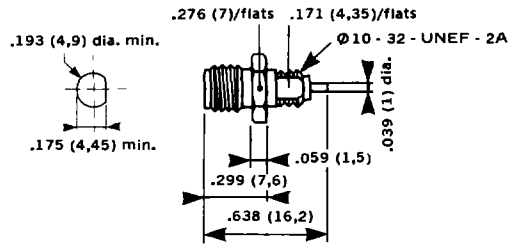

BULKHEAD RECEPTACLE - SCREW IN

PART NUMBER	R 125 560
Captive contact	YES

(For passivated stainless steel version, add suffix 001)

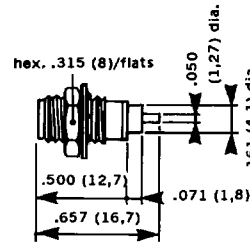

RIGHT ANGLE SQUARE FLANGE RECEPTACLE

PART NUMBER	R 125 654 450
Captive contact	YES

(Passivated stainless steel version : R 125 654 451)

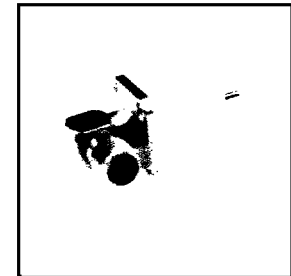
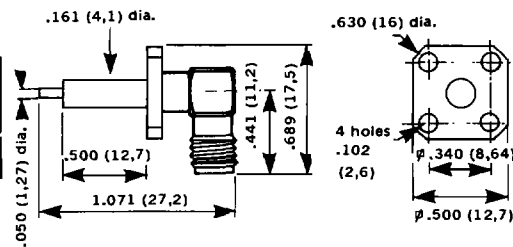

SMA

RECEPTACLES FOR PRINTED CIRCUIT BOARD MOUNTING

STRAIGHT PCB RECEPTACLE

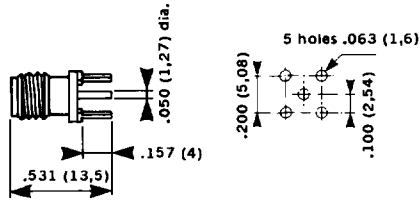
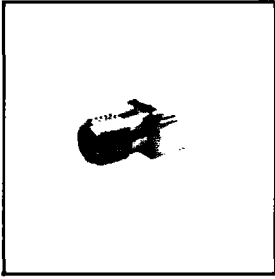

PART NUMBER	R 125 426
Captive contact	YES
MIL no.	93 - 4001

RIGHT ANGLE PCB RECEPTACLE

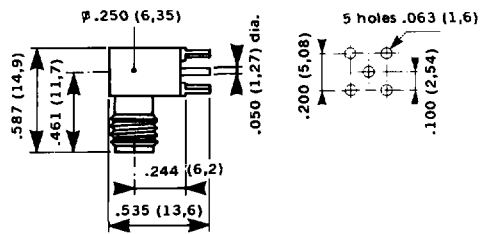
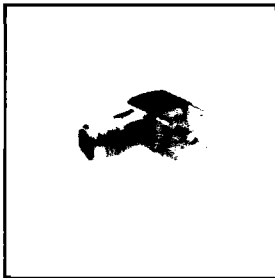

PART NUMBER	R 125 680
Captive contact	YES
MIL no.	94 - 4001

SURFACE MOUNT LAUNCHER

R 125 528

PART NUMBER	R 125 523	R 125 528
Captive contact	NO	NO

(For passivated stainless steel version, add suffix 001)
Frequency range DC - 4 GHz

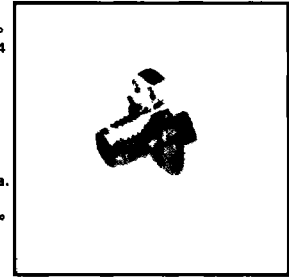
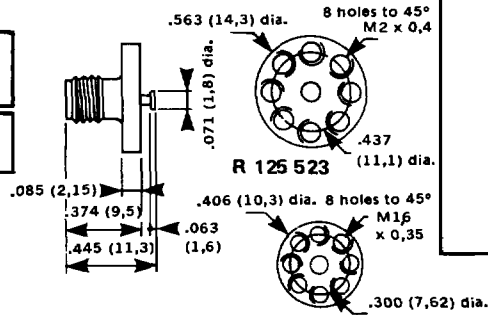

RIGHT ANGLE SURFACE MOUNT LAUNCHER

PART NUMBER	R 125 663
Captive contact	NO

(For passivated stainless steel version, add suffix 001)
Frequency range DC - 4 GHz

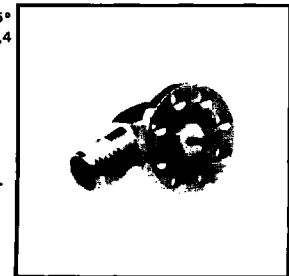
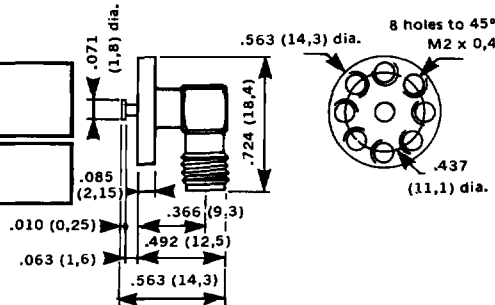

TRIPLATE LAUNCHER, END LAUNCH

PART NUMBER	R 125 539 (1)	R 125 541 (2)	R 125 542 (3)
Captive contact	YES	YES	YES
Dim. A	.062 (1,57)	.125 (3,17)	.250 (6,35)

(For passivated stainless steel version, add suffix 001)
Frequency range : (1) DC - 18 GHz (2) DC - 12.4 GHz (3) DC - 6 GHz

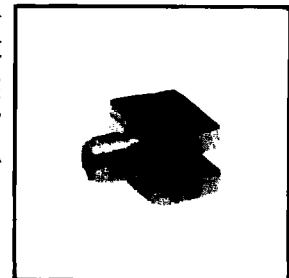
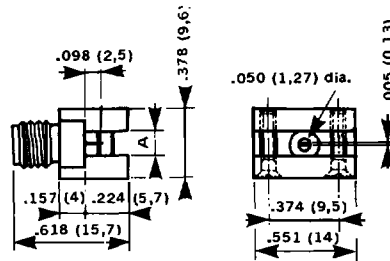

MALE TRIPLATE LAUNCHER, END LAUNCH

PART NUMBER	R 125 544
Captive contact	YES

(For passivated stainless steel version, add suffix 001)
Frequency range DC - 12.4 GHz

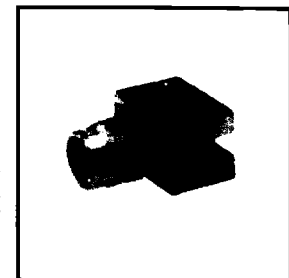
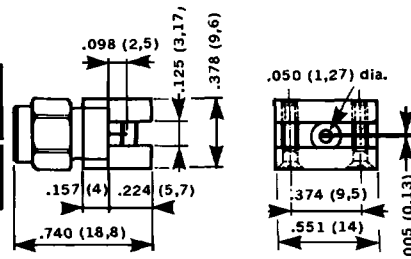

RECEPTACLES FOR STRIPLINE MIC PACKAGES

SQUARE FLANGE RECEPTACLE TAB CONTACT - FLUSH DIELECTRIC

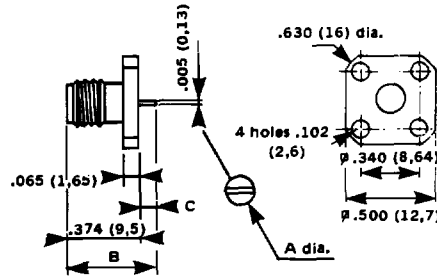
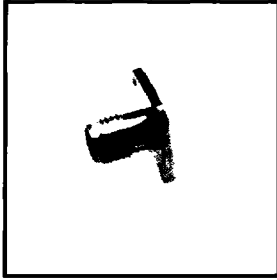

PART NUMBER	R 125 510	R 125 620
Captive contact	YES	YES
A dia.	.050 (1,27)	.024 (0,60)
Dim. B	.500 (12,7)	.409 (10,4)
Dim. C	.126 (3,2)	.035 (0,9)

(For passivated stainless steel version, add suffix 001)

SQUARE FLANGE RECEPTACLE TAB CONTACT - EXTENDED DIELECTRIC

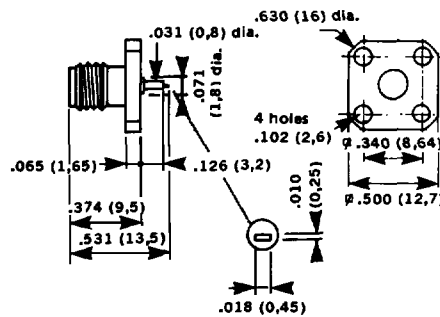
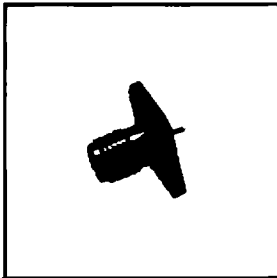

PART NUMBER	R 125 501
Captive contact	YES
Installation	M13

(For passivated stainless steel version, add suffix 001)

SQUARE FLANGE RECEPTACLE STUB CONTACT - EXTENDED DIELECTRIC

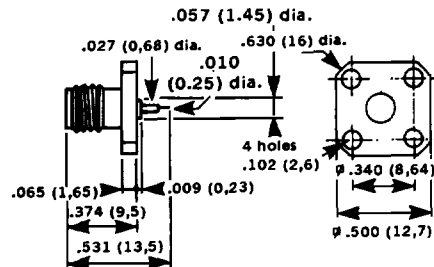
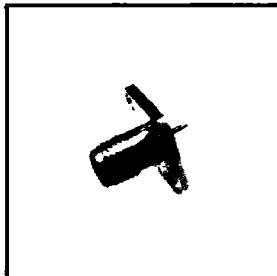

PART NUMBER	R 125 611 001
Captive contact	YES
Installation	M 14

(In passivated stainless steel)

SQUARE FLANGE RECEPTACLE SLOTTED CONTACT

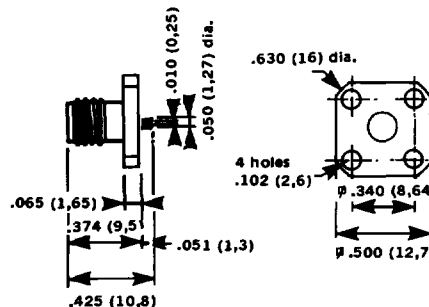
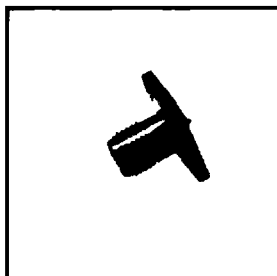

PART NUMBER	R 125 614 011
Captive contact	YES

(In passivated stainless steel)

MALE SQUARE FLANGE RECEPTACLE TAB CONTACT - FLUSH DIELECTRIC

PART NUMBER	R 125 488
Captive contact	YES

(For passivated stainless steel version, add suffix 001)

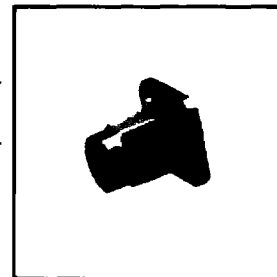
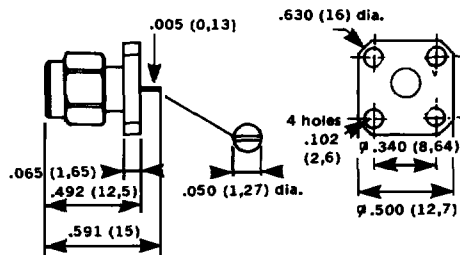

MALE SQUARE FLANGE RECEPTACLE TAB CONTACT - EXTENDED DIELECTRIC

PART NUMBER	R 125 500
Captive contact	YES
Installation	M 13

(For passivated stainless steel version, add suffix 001)

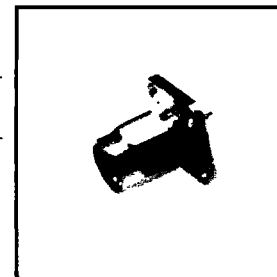
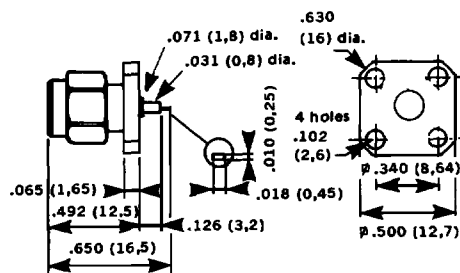

SMA

RECEPTACLES FOR STRIPLINE MIC PACKAGES

NARROW FLANGE RECEPTACLE TAB CONTACT - EXTENDED DIELECTRIC

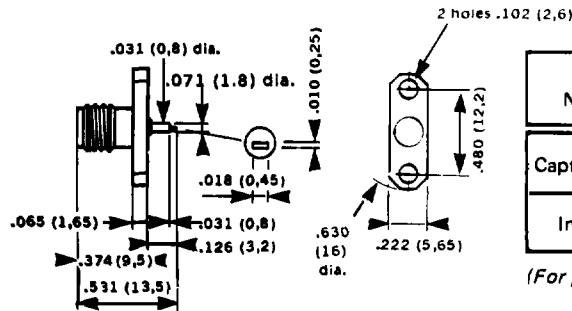
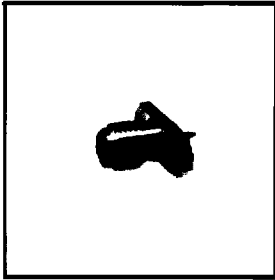

PART NUMBER	R 125 451
Captive contact	YES
Installation	M 13

(For passivated stainless steel version, add suffix 001)

NARROW FLANGE RECEPTACLE SOLDERLESS COMPRESSION CONTACT - FLUSH DIELECTRIC

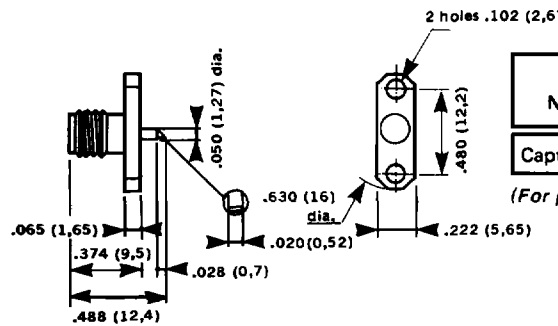
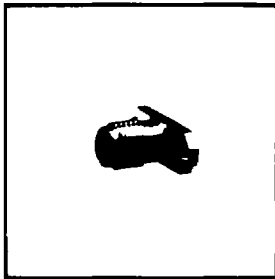

PART NUMBER	R 125 452
Captive contact	YES

(For passivated stainless steel version, add suffix 001)

NARROW FLANGE RECEPTACLE TAB CONTACT - FLUSH DIELECTRIC

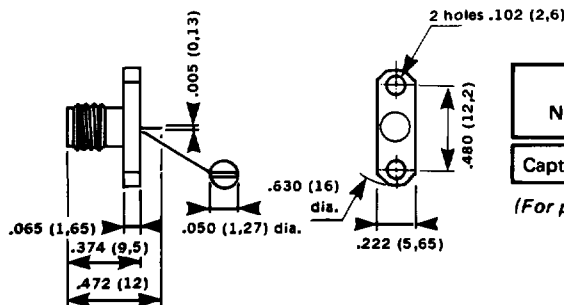
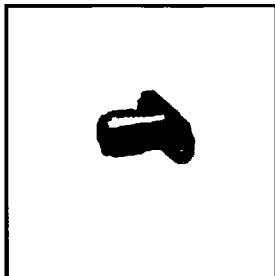

PART NUMBER	R 125 497
Captive contact	YES

(For passivated stainless steel version, add suffix 001)

NARROW FLANGE RECEPTACLE TAB CONTACT - FLUSH DIELECTRIC

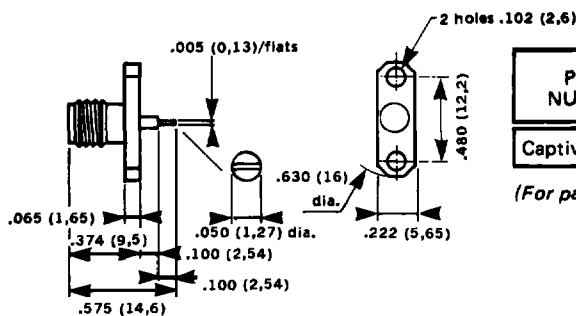
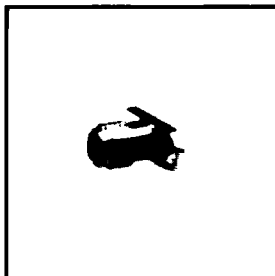

PART NUMBER	R 125 503
Captive contact	NO

(For passivated stainless steel version, add suffix 001)

SQUARE FLANGE RECEPTACLE STUB CONTACT - EXTENDED DIELECTRIC

PART NUMBER	R 125 512	R 125 513	R 125 612
Captive contact	YES	YES	YES
Dim. A	.563 (14,3)	.500 (12,7)	.563 (14,3)
Dim. B	.126 (3,2)	.063 (1,6)	.126 (3,2)
C dia.	.085 (2,16)	.085 (2,16)	.161 (4,1)
Installation	M 14	M 15	M 17

(For passivated stainless steel version, add suffix 001)

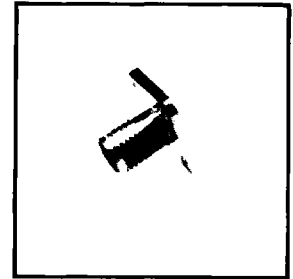
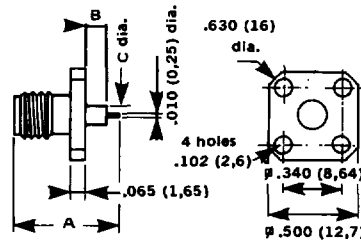

SQUARE FLANGE RECEPTACLE STUB CONTACT - EXTENDED DIELECTRIC

PART NUMBER	R 125 622
Captive contact	YES
Installation	M 18

(For passivated stainless steel version, add suffix 001)

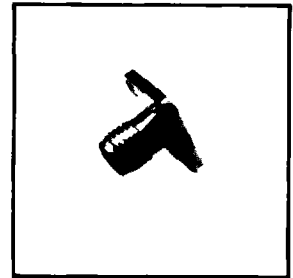
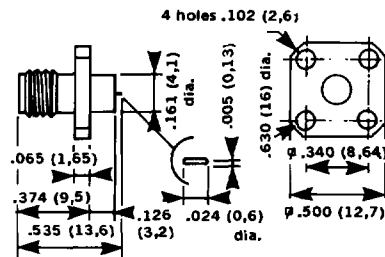

MALE SQUARE FLANGE RECEPTACLE STUB CONTACT - EXTENDED DIELECTRIC

PART NUMBER	R 125 492
Captive contact	YES
Installation	M 14

(For passivated stainless steel version, add suffix 001)

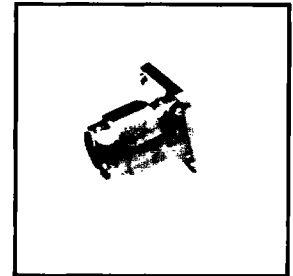
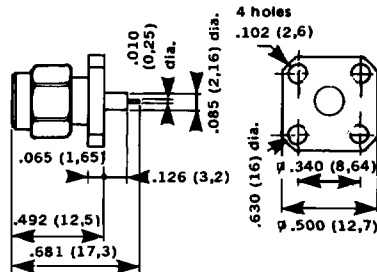

RECEPTACLES FOR STRIPLINE MIC PACKAGES

NARROW FLANGE RECEPTACLE STUB CONTACT - EXTENDED DIELECTRIC

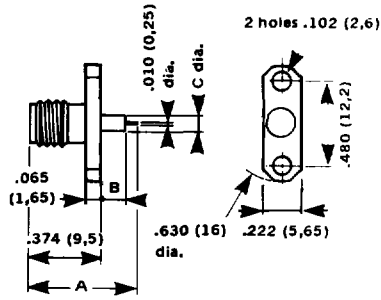
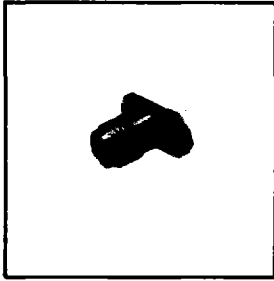

PART NUMBER	R 125 462	R 125 463	R 125 617
Captive contact	YES	YES	YES
Dim. A	.559 (14,2)	.500 (12,7)	.563 (14,3)
Dim. B	.126 (3,2)	.063 (1,6)	.126 (3,2)
C dia.	.085 (2,16)	.085 (2,16)	.161 (4,1)
Installation	M 14	M 15	M 17

(For passivated stainless steel version, add suffix 001)

MALE NARROW FLANGE RECEPTACLE STUB CONTACT - EXTENDED DIELECTRIC

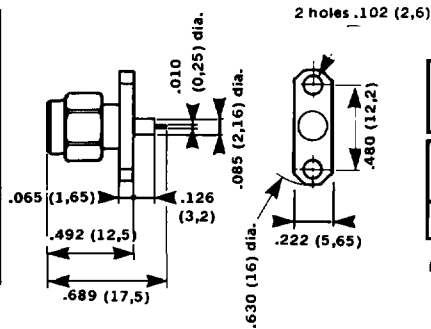
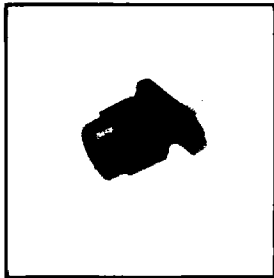

PART NUMBER	R 125 484
Captive contact	YES
Installation	M 14

(For passivated stainless steel version, add suffix 001)

HERMETICALLY SEALED RECEPTACLES FOR STRIPLINE MIC PACKAGES

SOLDER MOUNT RECEPTACLE - STUB CONTACT

PART NUMBER	R 125 630
Captive contact	YES
Installation	M 16

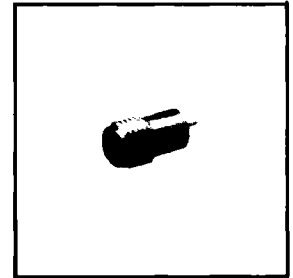
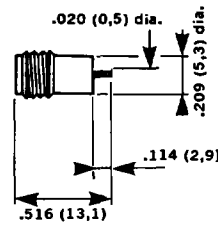

MALE SOLDER MOUNT RECEPTACLE - STUB CONTACT

PART NUMBER	R 125 633
Captive contact	YES
Installation	M 16

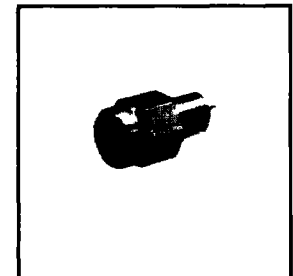
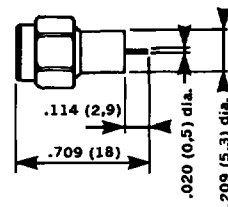

HERMETICALLY SEALED RECEPTACLE-SOLDER CONTACT

BULKHEAD RECEPTACLE

PART NUMBER	R 125 603
Captive contact	YES
MIL no.	62-4001

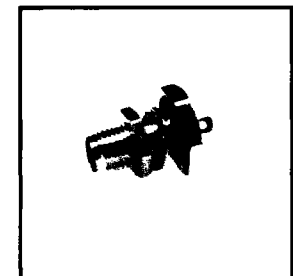
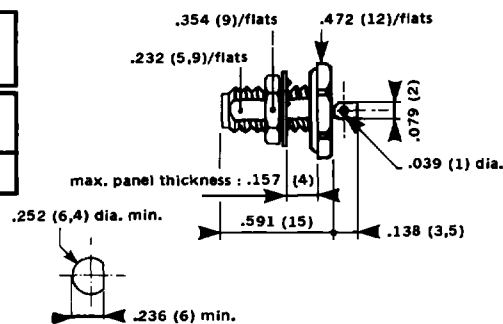

SMA

UNIVERSAL RECEPTACLES FOR STRIPLINE MIC PACKAGES

These receptacles are supplied with center contact and insulator. They have been developed especially for the coaxial outputs of MIC boxes. They can be used with several types of contacts and insulator beads fitted into the flange face. This design allows flexibility in both laboratory and manufacturing applications. Accepts a .036 inch diameter center pin.

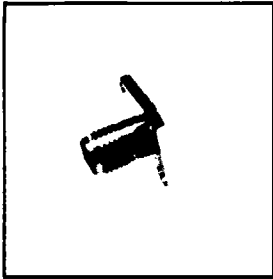

FEMALE SQUARE FLANGE RECEPTACLE

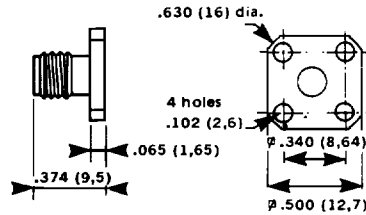

PART
NUMBER

R 125 410 001

(In passivated stainless steel)

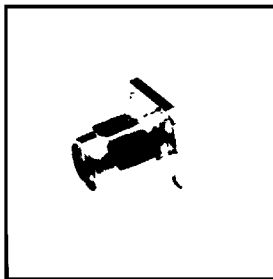

MALE SQUARE FLANGE RECEPTACLE

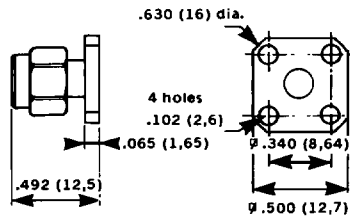

PART
NUMBER

R 125 430 001

(In passivated stainless steel)

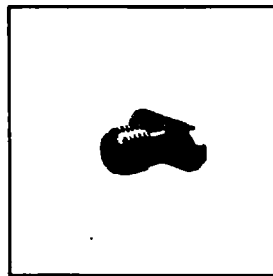

FEMALE NARROW FLANGE RECEPTACLE

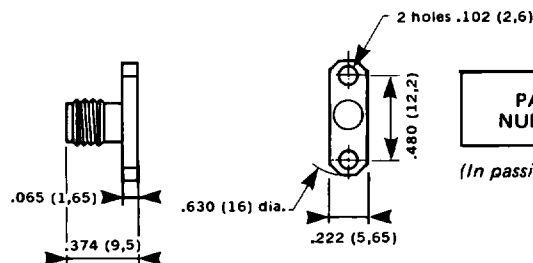

PART
NUMBER

R 125 460 001

(In passivated stainless steel)

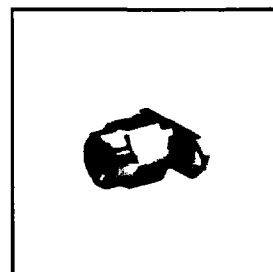

MALE NARROW FLANGE RECEPTACLE

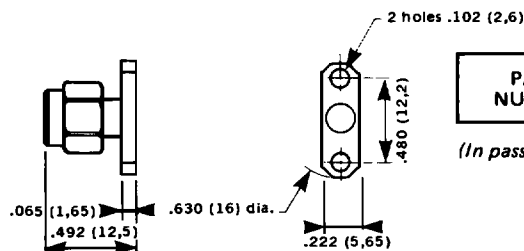

PART
NUMBER

R 125 480 001

(In passivated stainless steel)

UNIVERSAL RECEPTACLES FOR STRIPLINE MIC PACKAGES

RIGHT ANGLE SQUARE FLANGE RECEPTACLE

PART NUMBER **R 125 670 001**

(In passivated stainless steel)

Note: Accepts a .036 inch diameter center pin

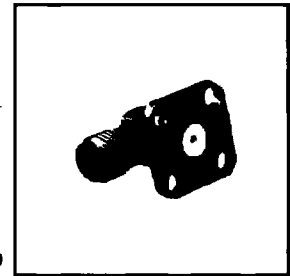
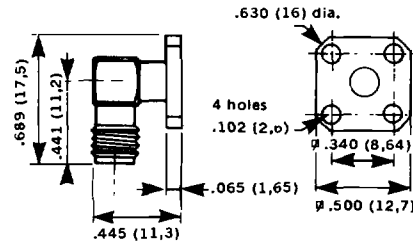

INTERCHANGEABLE CONTACTS AND INSULATOR BEADS

These accessories are introduced at the rear of the receptacles, dimensions are dependent of the circuits or the thickness of the boxes.
 (Note: When ordering, please note that contacts are packaged 10 to a bag.)

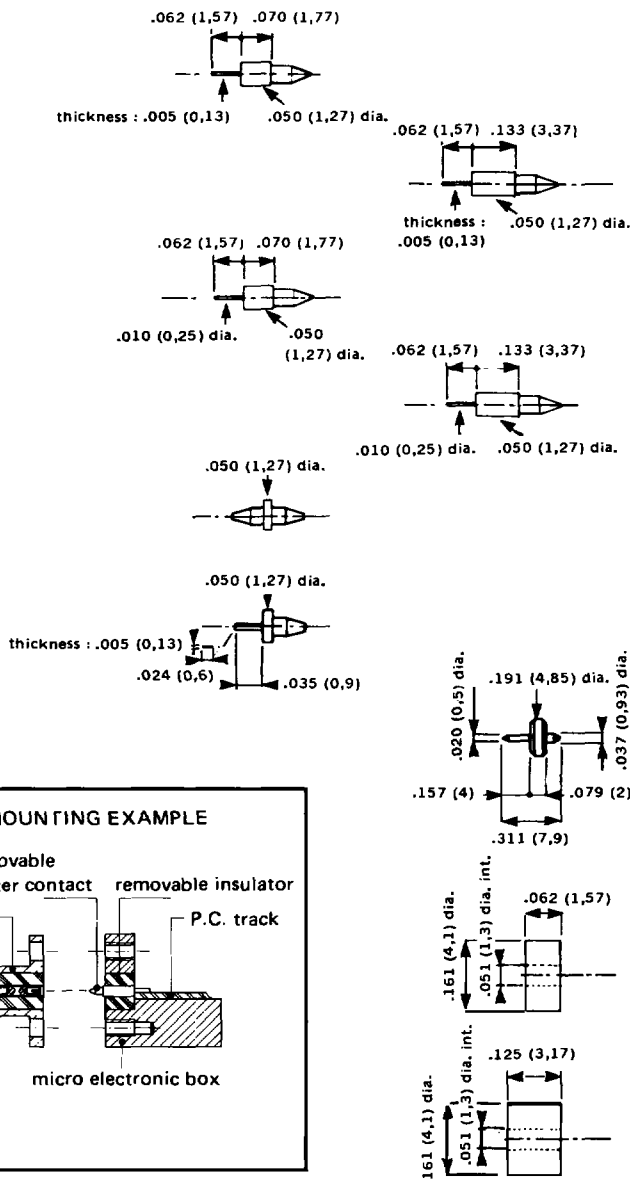

PART NUMBER	DESCRIPTION	box thickness in (mm)
R 280 460	removable contact termination post thickness 0.13 on flats packed by 10 pieces.	1,57
R 280 461	removable contact termination post thickness 0.13 on flats packed by 10 pieces.	3,17
R 280 462	removable contact termination post 0.25 diameter packed by 10 pieces.	1,57
R 280 463	removable contact termination post 0.25 diameter packed by 10 pieces.	3,17
R 280 464	removable contact termination post 1.27 diameter packed by 10 pieces.	
R 280 465	removable contact termination post thickness 0.13 on flats by 0.6 width packed by 10 pieces.	
R 280 940	removable contact with insulator glass bead	stripline installation M 21

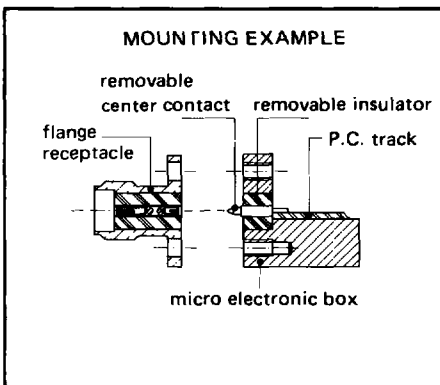

R 280 467	removable insulator 4.1 dia. x 1.57 long. packed by 10 pieces.	1,57
R 280 468	removable insulator 4.1 dia. x 3.17 long. packed by 10 pieces.	3,17

SMA

IN SERIES ADAPTORS

MALE - MALE

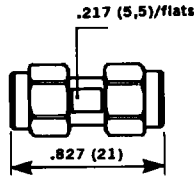
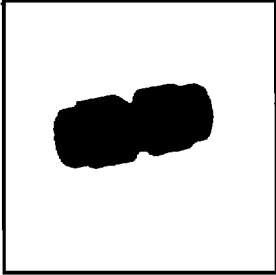

PART NUMBER	R 125 703
MIL no.	M 55339 / 29-30101

(For passivated stainless steel version, add suffix 001)

FEMALE - FEMALE

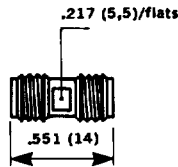

PART NUMBER	R 125 705
MIL no.	M 55339 / 31-30001

(For passivated stainless steel version, add suffix 001)

MALE - FEMALE (connector saver)

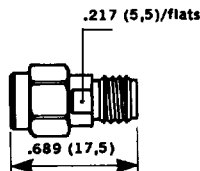
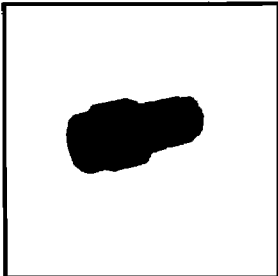

PART NUMBER	R 125 704
-------------	-----------

(For passivated stainless steel version, add suffix 001)

FEMALE - FEMALE BULKHEAD

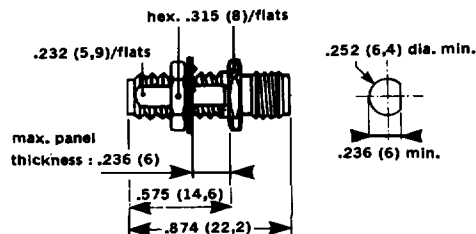
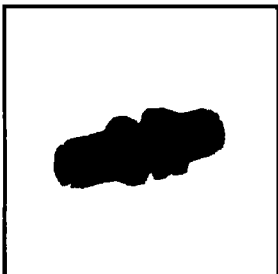

PART NUMBER	R 125 720
-------------	-----------

(For passivated stainless steel version, add suffix 001)

FEMALE - FEMALE HERMETICALLY SEALED BULKHEAD

PART NUMBER	R 125 753
MIL no.	M 55339 / 28 - 30001

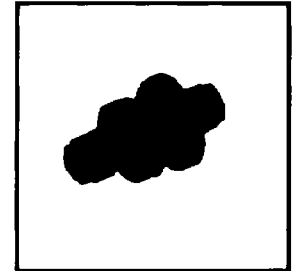
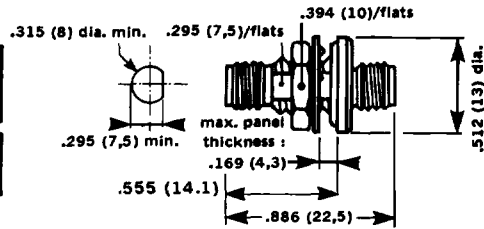

MALE - FEMALE RIGHT ANGLE

PART NUMBER	R 125 771
MIL no.	M 55339 / 02 - 30001

(For passivated stainless steel version, add suffix 001)

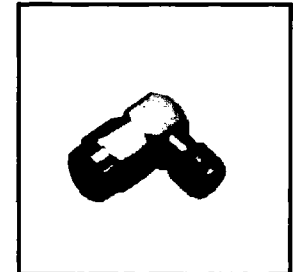
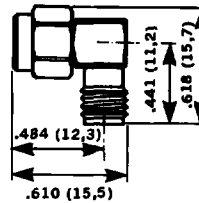

TEE FEMALE - FEMALE/MALE

PART NUMBER	R 125 780
-------------	-----------

(For passivated stainless steel version, add suffix 001)

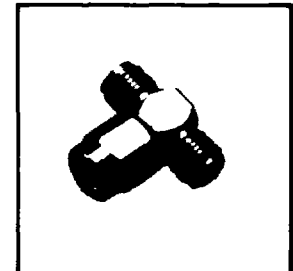
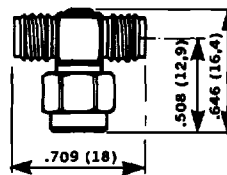

TEE FEMALE - FEMALE/FEMALE

PART NUMBER	R 125 781
-------------	-----------

(For passivated stainless steel version, add suffix 001)

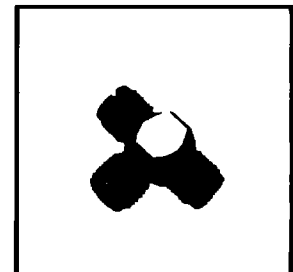
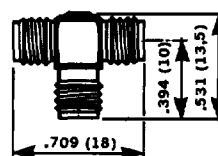

SMA

DUST CAPS AND SHORTS

MALE DUST CAP AND CHAIN

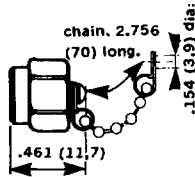
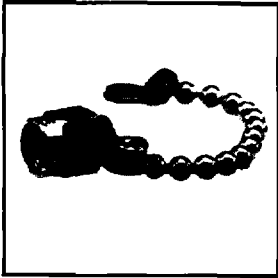

PART
NUMBER

R 125 812

(For passivated stainless steel version, add suffix 001)

MALE SHORT CIRCUIT CAP

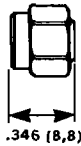
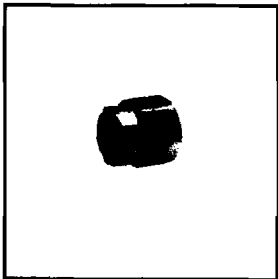

PART
NUMBER

R 125 852

(For passivated stainless steel version, add suffix 001)

R 282 120 TOOL KIT

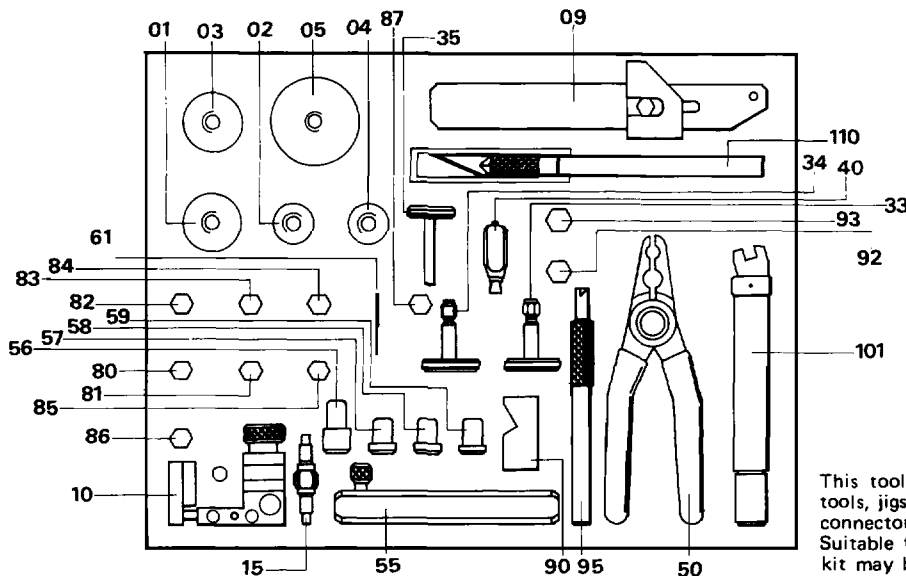

(01)	730.11.030	(59)	731.20.000
(02)	730.11.040	(61)	731.15.020
(03)	730.11.050		
(04)	730.11.060	(80)	730.40.004
(05)	730.11.070	(81)	730.30.005
(09)	730.11.000	(82)	730.15.004
(10)	730.15.021	(83)	730.30.002
(15)	731.15.010	(84)	730.40.025
(33)	730.25.006	(85)	730.40.003
(34)	730.25.005	(86)	730.40.012
(35)	730.25.042	(87)	730.40.027
(40)	730.60.001	(90)	730.20.080
(50)	730.81.021	(92)	731.40.000
(55)	764.49.010	(93)	731.40.020
(56)	731.20.020	(95)	730.22.010
(57)	731.20.030	(101)	730.80.220
(58)	731.20.010	(110)	730.22.000

This tool kit contains all the necessary stripping and bending tools, jigs and torque spanner to facilitate the assembly of SMA connectors onto semi-rigid cables.

Suitable for use with .085", .141" and .250" diameter cables the kit may be employed in the laboratory, the factory or the field to give perfect assembly and optimum r.f. performance up to 18 GHz or 26,5 GHz.

TORQUE WRENCH : R 282 320

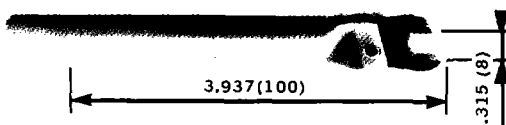

This torque wrench is preset to the recommended tightening torque and designed specifically for tightening the coupling nuts of male connectors to the correct torque.

Its use avoids damage to the interfaces and ensures good resistance to shock and vibration.

HERMETIC SEPARATE GLASS BEAD RECEPTACLES

SQUARE FLANGE PLUG

PART NUMBER	R 125 431 001 * R 125 431 201	R 125 431 011 * R 125 431 211
Pin Diameter	.012 (0.3)	.018 (0.5)
VSWR	1.10 + 0.01 F (GHz)	
Panel Drilling	P 01	P 02

4 Holes .102(2,6) dia.

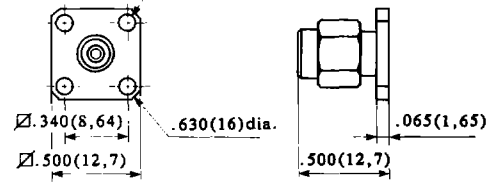

* : With EMI/RFI gasket

2 - HOLE FLANGE PLUG

PART NUMBER	R 125 481 001 * R 125 481 201	R 125 481 011 * R 125 481 211
Pin Diameter	.012 (0.3)	.018 (0.5)
VSWR	1.10 + 0.01 F (GHz)	
Panel Drilling	P 01	P 02

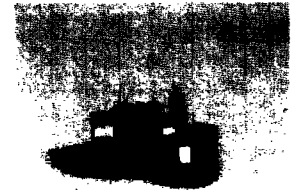
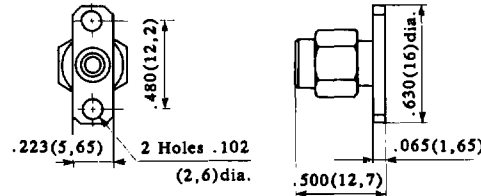

* : With EMI/RFI gasket

SQUARE FLANGE JACK

PART NUMBER	R 125 411 001 * R 125 411 201	R 125 411 011 * R 125 411 211
Pin Diameter	.012 (0.3)	.018 (0.5)
VSWR	1.10 + 0.01 F (GHz)	
Panel Drilling	P 01	P 02

4 Holes .102(2,6) dia.

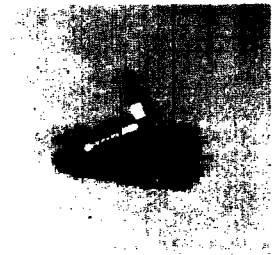
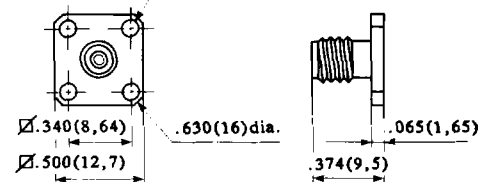

* : With EMI/RFI gasket

2 - HOLE FLANGE JACK

PART NUMBER	R 125 465 001 * R 125 465 201	R 125 465 011 * R 125 465 211
Pin Diameter	.012 (0.3)	.018 (0.5)
VSWR	1.10 + 0.01 F (GHz)	
Panel Drilling	P 01	P 02

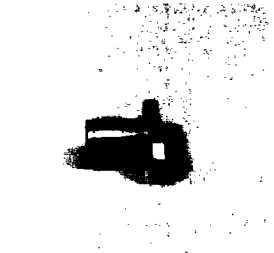
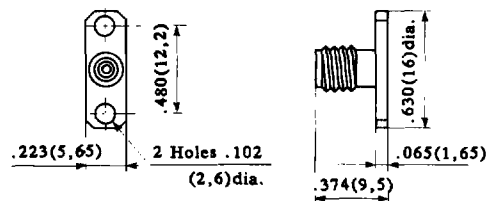

* : With EMI/RFI gasket

The standard units are passivated stainless steel. For gold plated versions, change the part number suffix from 1 to 0.

SMA

HERMETIC SEPARATE GLASS BEAD RECEPTACLES

PANEL FEEDTHROUGH JACK

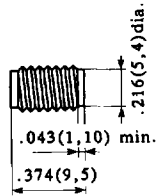

PART NUMBER	R 125 556 001	R 125 556 011
Pin Diameter	.012 (0.3)	.018 (0.5)
VSWR	1.10 + 0.01 F (GHz)	
Panel Drilling	P 03	P 04

The standard units are passivated stainless steel. For gold plated versions, change the part number suffix from 1 to 0.

HERMETIC SCREW-ON RECEPTACLES

ENVIRONMENTALLY DURABLE PANEL FEEDTHROUGH

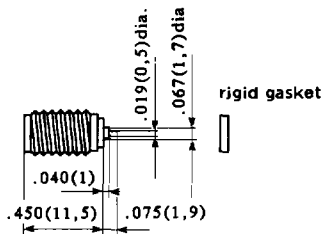
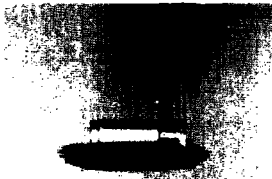

PART NUMBER	R 125 609
Frequency range	DC - 26.5 GHz
Thermal Shocks	- 65 ° to + 125 ° C 1000 cycles
VSWR	DC - 18 GHz 1.06 + 0.006 F (GHz) 18 - 26,5 GHz 1.08 + 0.006 F (GHz)
Panel Drilling	P 05

ENVIRONMENTALLY DURABLE PANEL FEEDTHROUGH JACK WITH SLIDING CONTACT

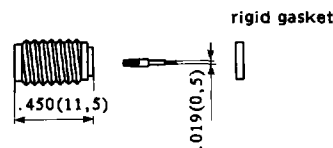

PART NUMBER	R 125 609 010
Frequency range	DC - 26.5 GHz
Thermal Shocks	- 65 ° to + 125 ° C 1000 cycles
VSWR	1.04 + 0.009 F (GHz)
Panel Drilling	P 05

The standard units are gold plated. For passivated stainless steel versions, change the part number suffix from 0 to 1.

ACCESSORIES FOR HERMETIC SEPARATE GLASS BEAD RECEPTACLES

SOLDER HERMETIC GLASS BEAD

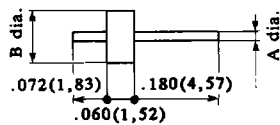

PART NUMBER	R 280 751	R 280 755
A Diameter	.012 (0.3)	.018 (0.5)
B Diameter	.099 (2.5)	.112 (2.8)

REMOVABLE CONTACT

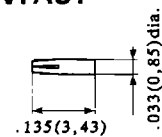

PART NUMBER	R 280 469	R 280 469 010
Pin Diameter	.012 (0.3)	.018 (0.5)

PANEL DRILLING P 01 and P 02

	P 01	P 02
A dia.	.102 ± .001 (2.6 ± 0.025)	.115 ± .001 (2.92 ± 0.025)
B dia.	.127 ± .001 (3.23 ± 0.025)	.140 ± .001 (3.55 ± 0.025)
C dia.	.079 ± .0008 (2 ± 0.02)	
	(2). .028 ± .0008 (0.7 ± 0.02)	.043 ± .0008 (1.08 ± 0.02)
D	.1 ± .004 (2.5 ± 0.1)	
	From .04 to .157 (from 1 mm to 4 mm)	

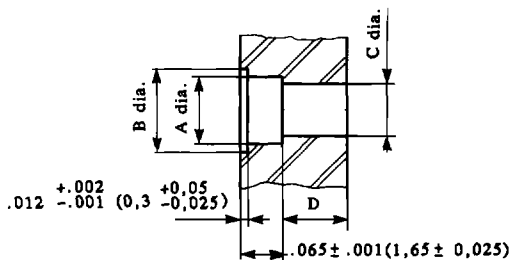

- 1) Using of the removable contact
- 2) The bead pin is directly welded on the track

PANEL DRILLING P 03 and P 04

	P 03	P 04
A dia.	.102 ± .001 (2.6 ± 0.025)	.115 ± .001 (2.92 ± 0.025)
B dia.	.127 ± .001 (3.23 ± 0.025)	.140 ± .001 (3.55 ± 0.025)
C dia.	.079 ± .0008 (2 ± 0.02)	
	(2). .028 ± .0008 (0.7 ± 0.02)	.043 ± .0008 (1.08 ± 0.02)
D	.1 ± .004 (2.5 ± 0.1)	
	From .04 to .157 (from 1 mm to 4 mm)	

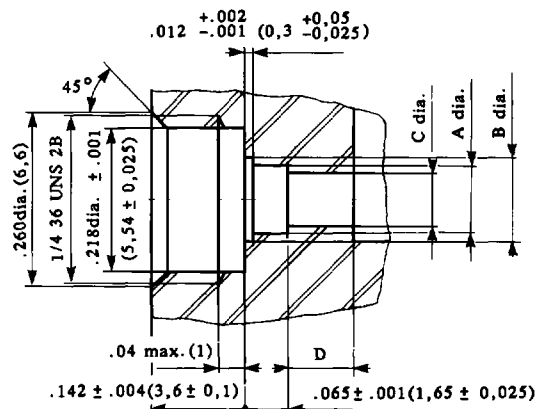

- 1) Using of the removable contact
- 2) The bead pin is directly welded on the track

For the P 01, P 02, P 03, P 04 panel drilling, the C and D dimensions have to be determined according to each using situation. We advise in the two following situations :

- 1) Using of the removable contact
- 2) The bead pin is directly welded on the track

PANEL DRILLING P 05

MOUNTING

Assemble metal gasket onto connector. Screw the whole into the housing. Tighten the connector up to 25 inch-pounds torque (use special tooling set RADIAL R 282 341). Thus the connexion hermiticity is guaranteed at 10^{-8} cc/sec. Then weld the pin on the track. We advise a Sn Pb 60/40 welding with a .012 wire (T 180° C). Beware there is not too much welding.

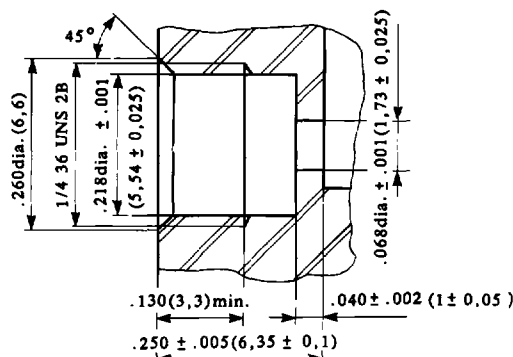

MOUNTING INSTRUCTIONS

M 01

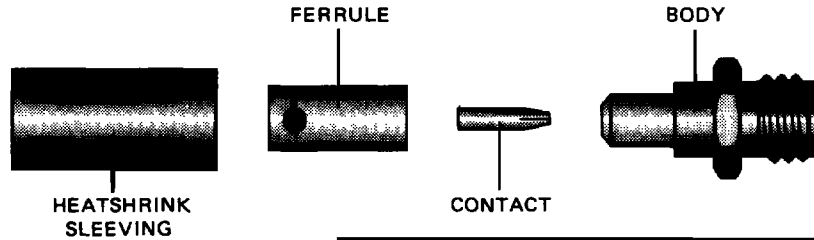

1

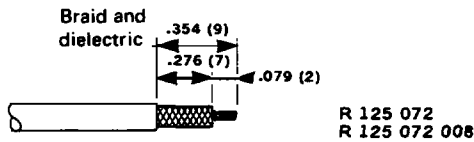

2

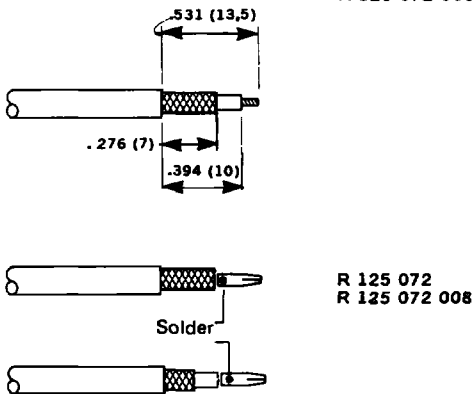

3

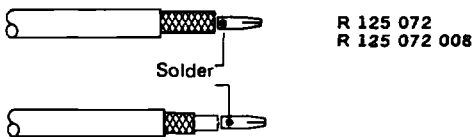

4

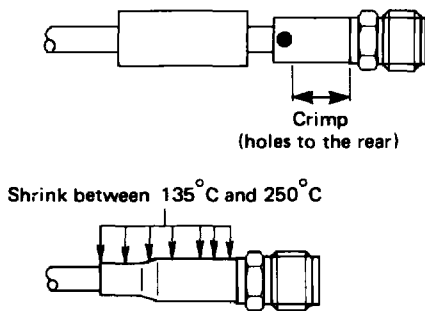

CONNECTORS	TOOLING	
R 125 072 R 125 072 008	RADIALL crimp tool	R 282 211
	or RADIALL crimp tool + RADIALL crimp dies	R 282 240 R 282 241
R 125 075 R 125 076 R 125 237 R 125 238	or BUCHANAN crimp tool + BUCHANAN crimp dies	612 648 612 784
	2.6 mm Ø cable : Hex. 3,25	
R 125 075 R 125 076 R 125 237 R 125 238	RADIALL crimp tool	R 282 223
	or RADIALL crimp tool + RADIALL crimp dies	R 282 240 R 282 242
R 125 075 R 125 076 R 125 237 R 125 238	or BUCHANAN crimp tool + BUCHANAN crimp dies	612 648 612 700
	5 mm Ø cable : Hex. 5,41	

- 1 - 1 Place heatshrink sleeving and ferrule onto the cable
- 1 - 2 Strip the cable

- 2 - 1 Solder the contact
- 2 - 2 Flare the braid

- 3 - 1 Position the body onto the cable
- 3 - 2 Crimp or solder the ferrule
 - pass.st. steel connector : crimp
 - gold plated connector : crimp or solder

- 4 - 1 Shrink the heatshrink sleeving over the ferrule

MOUNTING INSTRUCTIONS

I

M 02

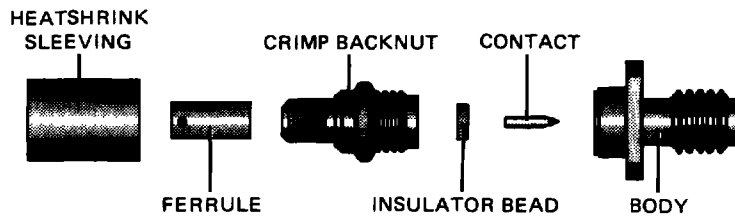

CONNECTOR	TOOLING
R 125 272	RADIALL crimp tool R 282 211 or RADIALL crimp tool R 282 240 + RADIALL crimp dies R 282 241
	or BUCHANAN crimp tool 612 648 + BUCHANAN crimp dies 612 784
	2.6 mm Ø cable : Hex. 3,25

- 1 - 1 Place heatshrink sleeving and ferrule onto the cable
- 1 - 2 Strip the cable

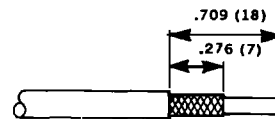

- 2 - 1 Slide the crimp backnut down between dielectric and braid
- 2 - 2 Crimp or solder the ferrule
 - pass.st.steel connector : crimp
 - gold plated connector : crimp or solder

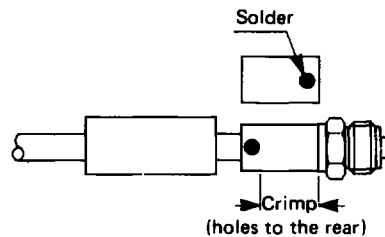

- 3 - 1 Cut the dielectric
- 3 - 2 Fit the insulator bead over the conductor
- 3 - 3 Solder the contact, ensuring that the contact bottoms onto the insulator bead

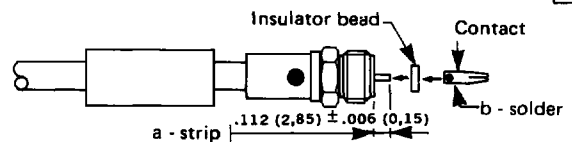

- 4 - 1 Insert sub-assembly into the body

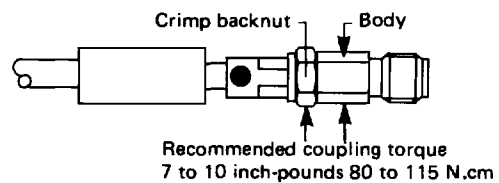

- 5 - 1 Shrink the heatshrink sleeving over the ferrule

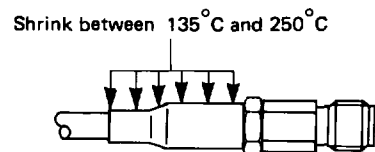

MOUNTING INSTRUCTIONS

M 03



1

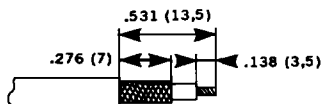

2

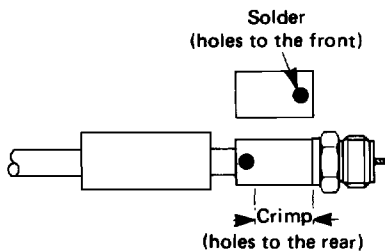

3

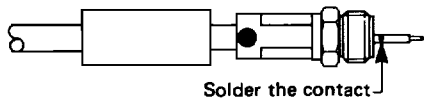

4

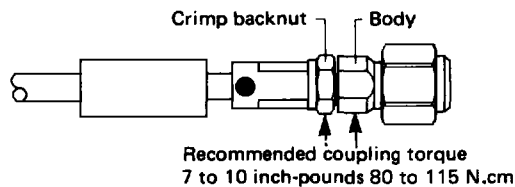

5

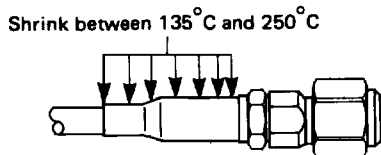

CONNECTORS	TOOLING	
R 125 073 R 125 074 R 125 236 R 125 303	RADIALL crimp tool	R 282 211
	or RADIALL crimp tool + RADIALL crimp dies	R 282 240 R 282 241
	or BUCHANAN crimp tool + BUCHANAN crimp dies	612 648 612 784
	2.6 mm Ø cable : Hex. 3,25 3.8 mm Ø cable : Hex. 4,50	
R 125 077 R 125 078 R 125 308	RADIALL crimp tool	R 282 223
	or RADIALL crimp tool + RADIALL crimp dies	R 282 240 R 282 242
	or BUCHANAN crimp tool + BUCHANAN crimp dies	612 648 612 700
	5 mm Ø cable : Hex. 5,41	

- 1 - 1 Place heatshrink sleeving and ferrule onto the cable
- 1 - 2 Strip the cable
- 1 - 3 Flare the braid

- 2 - 1 Slide the crimp backnut down between dielectric and braid
- 2 - 2 Crimp or solder the ferrule
 - pass.st.steel connector : crimp
 - gold plated connector : crimp or solder

- 3 - 1 Solder the contact ensuring that the contact has been pushed home into the rear insulator

- 4 - 1 Insert sub-assembly into the body

- 5 - 1 Shrink the heatshrink sleeving over the ferrule

MOUNTING INSTRUCTIONS

M 04

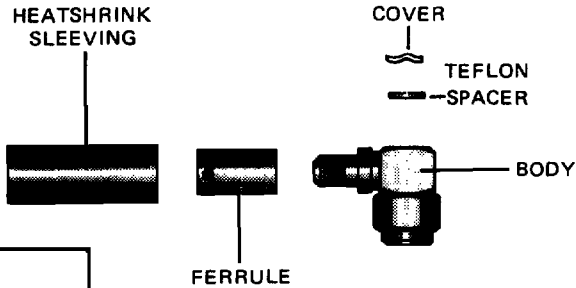

CONNECTORS	TOOLING
R 125 172	Tool kit R 282 120 positioner Item 30
	+ RADIALL crimp tool R 282 211
	or RADIALL crimp tool R 282 240
	+ RADIALL crimp dies R 282 241
R 125 175 R 125 176	or BUCHANAN crimp tool 612 648
	+ BUCHANAN crimp dies 612 784
	2.6 mm Ø cable : Hex. 3,25
	Tool kit R 282 120 positioner Item 30
R 125 175 R 125 176	+ RADIALL crimp tool R 282 223
	or RADIALL crimp tool R 282 240
	+ RADIALL crimp dies R 282 242
	or BUCHANAN crimp tool 612 648
R 125 176	+ BUCHANAN crimp dies 612 700
	5 mm Ø cable : Hex 5.41

- 1 - 1 Place heatshrink sleeving and ferrule onto the cable
1 - 2 Strip the cable

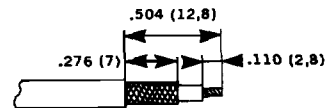

- 2 - 1 Flare the braid
2 - 2 Position the body onto the cable
2 - 3 Secure the positioner into the body
2 - 4 Crimp or solder the ferrule
- pass.st.steel connector : crimp
- gold plated connector : crimp or solder

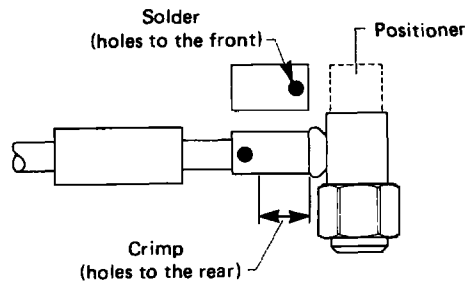

- 3 - 1 Remove the positioner
3 - 2 Solder the contact
3 - 3 Solder the cover (gold version) or for passivated st.steel version fit the teflon spacer and then press the cover into place with punch tool.

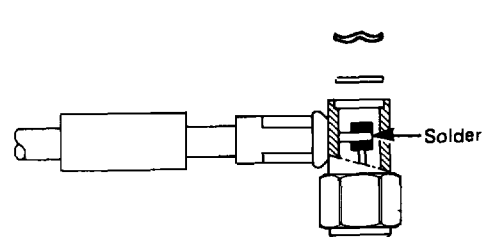

- 4 - 1 Shrink the heatshrink sleeving over the ferrule

Shrink between 135° C and 250° C

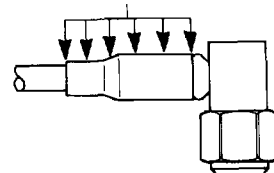

MOUNTING INSTRUCTIONS

M 05

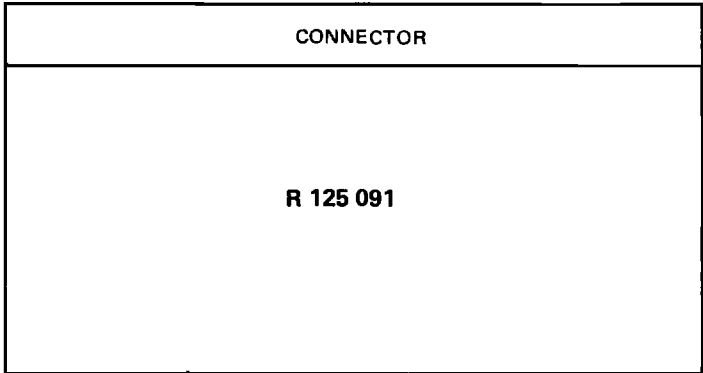
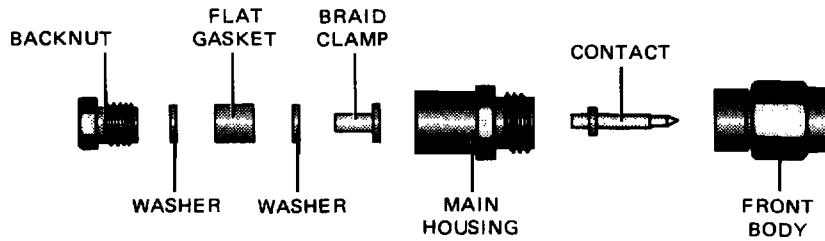

1

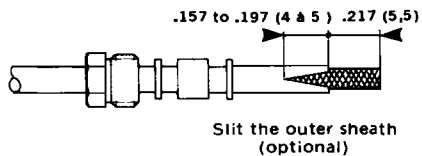

- 1 - 1 Slide the backnut, washer, gasket, washer over the cable
- 1 - 2 Strip the cable
- 1 - 3 Slit the sheath (optional) to ease positioning of the braid clamp under the braid.

2

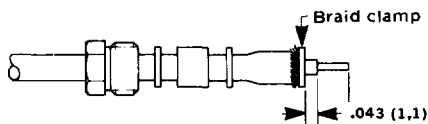

- 2 - 1 Slide the braid clamp between the dielectric and the braid
- 2 - 2 Trim the braid flush with the diameter of the braid clamp
- 2 - 3 Cut the dielectric.

3

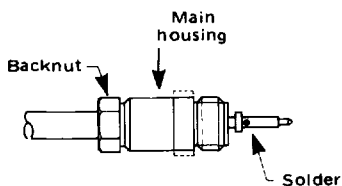

- 3 - 1 Insert sub-assembly into the main housing
- 3 - 2 Solder the contact.

4

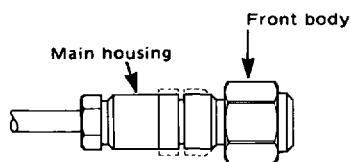

- 4 - 1 Insert sub-assembly into the front body.

MOUNTING INSTRUCTIONS

NOTE : It is recommended that semi-rigid cable with a silvered copper covered steel conductor is used as the conductor becomes the center contact.

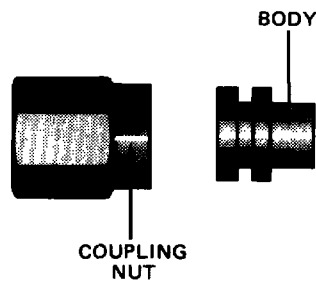

M 07

CONNECTOR	TOOLING
R 125 054 500	Tool kit R 282 120
	assembly jig Item 10
	positioner 82
	cable trimming tool 59
	cable cutting collet 55
	conductor filing gauge 90
	plus 100 or 250 W resistance soldering iron with tweezers.

- 1 - 1 Slide the coupling nut over the cable before beginning the assembly operation
- 1 - 2 Place the cable into the assembly jig
- 1 - 3 Place the connector body and positioner onto the cable, then clamp the cable
- 1 - 4 Put 3 rings of solder around the cable
- 1 - 5 Solder the body onto the semi-rigid.

- 2 - 1 After the sub-assembly has cooled, remove it from the jig
- 2 - 2 Trim extended dielectric flush with the end of the cable outer.

- 3 - 1 Insert the connector body into the cable trimming tool and collet
- 3 - 2 Saw through cable outer whilst turning seated sub-assembly.

- 4 - 1 Cut through dielectric and bare inner conductor
- 4 - 2 Inspect sub-assembly and clean unit free from all chips, foreign matter etc.

- 5 - 1 Push home sub-assembly into the conductor filing gauge and file the conductor to a point while turning the cable.

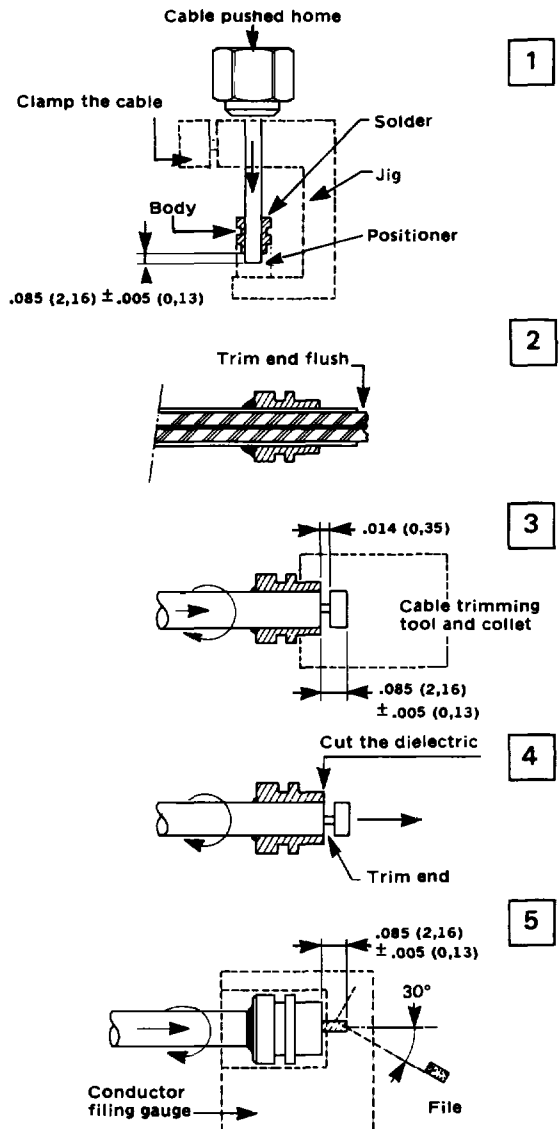

MOUNTING INSTRUCTIONS

M 08

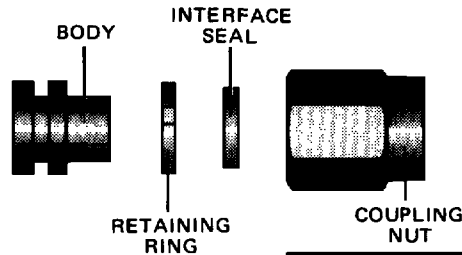

NOTE : It is recommended that semi-rigid cable with a silvered copper covered steel conductor is used as the conductor becomes the center contact.

1

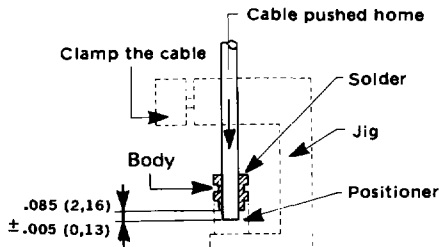

2

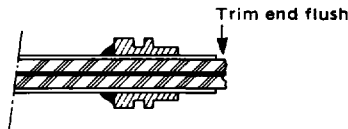

3

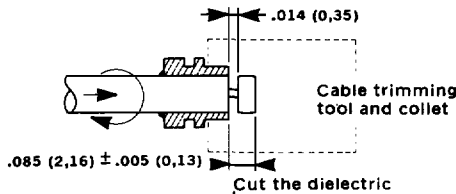

4

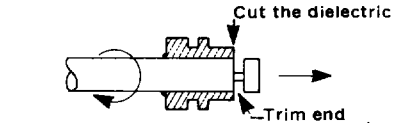

5

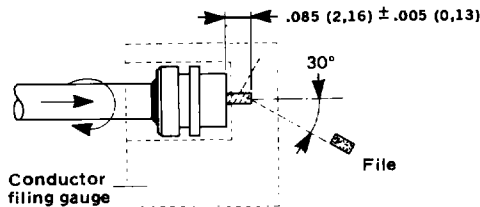

6

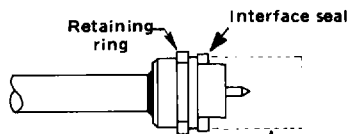

7

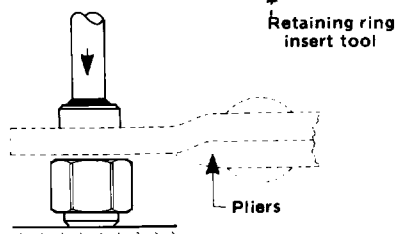

CONNECTORS	TOOLING
	Tool kit R 282 120
	assembly jig 10
	positioner 82
R 125 054	cable trimming tool 55
R 125 057	cable cutting collet 59
	conductor filing gauge 90
	retaining ring insert tool 40
	retaining ring pliers 50
	plus 100 or 250 W resistance soldering iron with tweezers

- 1 - 1 Place the cable into the assembly jig
- 1 - 2 Place the connector body and positioner onto the cable, then clamp the cable
- 1 - 3 Put 3 rings of solder around the cable
- 1 - 4 Solder the body onto the semi-rigid.
- 2 - 1 After the sub-assembly has cooled, remove it from the jig
- 2 - 2 Trim extended dielectric flush with the end of the cable outer.
- 3 - 1 Insert the connector body into the cable trimming tool and collet
- 3 - 2 Saw through cable outer while turning seated sub-assembly.
- 4 - 1 Cut through dielectric and bare inner conductor
- 4 - 2 Inspect sub-assembly and clean unit free from all chips, foreign matter etc.
- 5 - 1 Push home sub-assembly into the conductor filing gauge and file the conductor to a point while turning the cable.
- 6 - 1 Place the interface seal O ring onto body
- 6 - 2 Place retaining ring onto its insert tool
- 6 - 3 Push sub-assembly into the tool until the retaining ring snaps into place.
- 7 - 1 Compress retaining ring using retaining ring pliers
- 7 - 2 Push coupling nut onto sub-assembly and over retaining ring.

MOUNTING INSTRUCTIONS

M 09

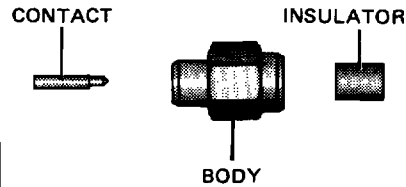

CONNECTORS	TOOLING				
	Tool kit R 282 120				
R 125 052		Item		Item	
	cable trimming tool	.085" cable	55	.141" cable	55
R 125 052 500	cable cutting collet	"	57	"	58
	positioner	"	85	"	87
R 125 055	assembly jig	"	10	"	10
	contact holder	"	15	"	15
R 125 055 500	spacer	"	61	"	61
	trimmer locator	"	93	"	93
R 125 055 500	dielectric trimmer	"	95	"	95
	dielectric insert tool	"	34	"	34
	dielectric plunger	"	35	"	35
	plus 100 or 250 W resistance soldering iron with tweezers				

- 1 - 1 For R 125 052 500 and R 125 055 500 slide the retractable coupling nut over the cable before beginning the assembly operation
- 1 - 2 Insert the cable into the cable trimming tool and cable cutting collet
- 1 - 3 Saw through cable outer and into dielectric while turning the cable.
- 2 - 1 Cut through the dielectric and bare inner conductor
- 2 - 2 Trim the end of the cable
- 2 - 3 Inspect cable and clean free from all chips, foreign matter etc.
- 3 - 1 Place the cable into the assembly jig
- 3 - 2 Position the contact, spacer and contact holder as shown
- 3 - 3 Solder the contact
- 4 - 1 After the sub-assembly has cooled, remove it from the jig
- 4 - 2 Screw the body and positioner together
- 4 - 3 Place cable into the body until the contact bottoms with the positioner and clamp the cable
- 4 - 4 Put 3 rings of solder around the cable and solder the body onto the semi-rigid.
- 5 - 1 After the sub-assembly has cooled, remove it from the jig
- 5 - 2 Screw the trimmer locator into the connector and insert dielectric trimmer to remove any surplus PTFE from the face of the semi-rigid.
- 6 - 1 Screw the dielectric insert tool into the body and insert the insulator with the plunger.

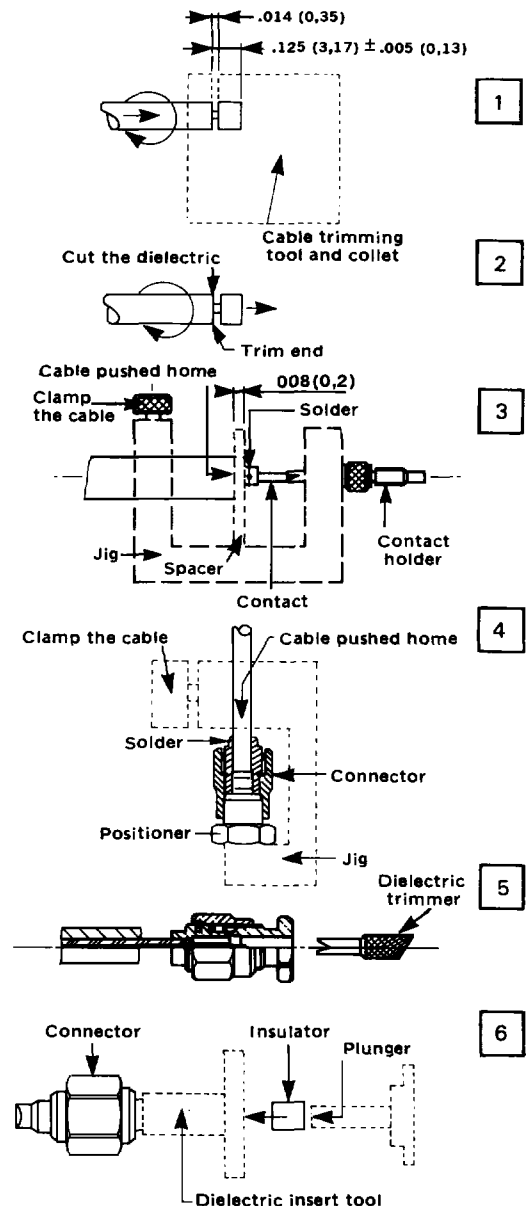

MOUNTING INSTRUCTIONS

M 10

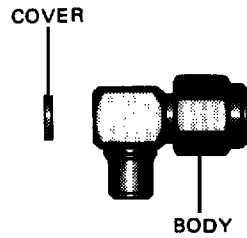

1

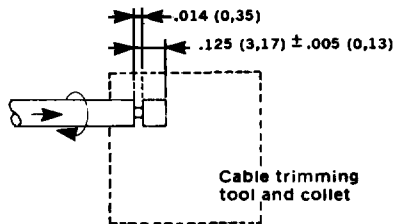

2

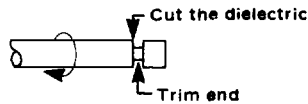

3

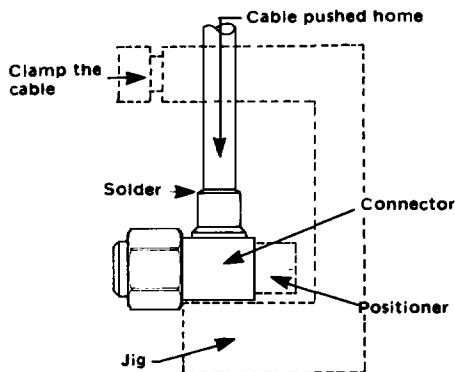

4

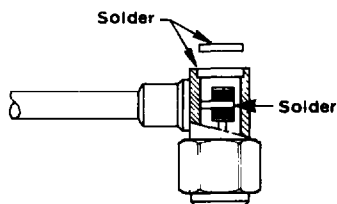

CONNECTORS	TOOLING			
	Tool kit R 282 120			
		Item		Item
R 125 153	cable trimming tool	.085 " cable	.141 " cable	55
	cable cutting collet	"	"	57
R 125 154	positioner	"	"	84
	assembly jig	"	"	10
	plus 100 or 250 W resistance soldering iron with tweezers			

- 1 - 1 Insert the cable into the cable trimming tool and cable cutting collet
- 1 - 2 Saw through cable outer and into dielectric while turning the cable.

- 2 - 1 Cut through the dielectric and bare inner conductor
- 2 - 2 Trim the end of the cable
- 2 - 3 Inspect cable and clean free from all chips, foreign matter etc.

- 3 - 1 Insert the cable into the body
- 3 - 2 Secure the positioner into the body
- 3 - 3 Place the sub-assembly into the assembly jig
- 3 - 4 Put 3 rings of solder around the cable and solder the body onto the semi-rigid.

- 4 - 1 After the sub-assembly has cooled, remove it from the jig
- 4 - 2 Remove the positioner
- 4 - 3 Solder the contact
- 4 - 4 Solder the cover.

MOUNTING INSTRUCTIONS

M 11

CONNECTORS	TOOLING			
R 125 222	Tool kit R 282 120			
R 125 225		Item	Item	
R 125 251	cable trimming tool	.085" cable 55	.141" cable 55	
	cable cutting collet	" 57	" 58	
	positioner	" 85	" 86	
	assembly jig	" 10	" 10	
R 125 252	contact holder	" 15	" 15	
	spacer	" 61	" 61	
R 125 255	trimmer locator	" 92	" 92	
	dielectric trimmer	" 95	" 95	
R 125 256	dielectric insert tool	" 33	" 33	
R 125 325	dielectric plunger	" 35	" 35	
R 125 326	plus 100 or 250 W resistance soldering iron with tweezers.			

CONTACT



BODY



INSULATOR

- 1 - 1 Insert the cable into the cable trimming tool and cable cutting collet
- 1 - 2 Saw through cable outer and into dielectric while turning the cable.

- 2 - 1 Cut through the dielectric and bare inner conductor
- 2 - 2 Trim the end of the cable
- 2 - 3 Inspect cable and clean free from all chips, foreign matter etc.

- 3 - 1 Place the cable into the assembly jig
- 3 - 2 Position the contact, spacer and contact holder as shown
- 3 - 3 Solder the contact.

- 4 - 1 After the sub-assembly has cooled, remove it from the jig
- 4 - 2 Screw the body and positioner together
- 4 - 3 Place cable into the body until the contact bottoms with the positioner and clamp the cable
- 4 - 4 Put 3 rings of solder around the cable and solder the body onto the semi-rigid.

- 5 - 1 After the sub-assembly has cooled, remove it from the jig
- 5 - 2 Screw the trimmer locator into the connector and insert dielectric trimmer to remove any surplus PTFE from the face of the semi-rigid.

- 6 - 1 After the sub-assembly has cooled, remove it from the jig
- 6 - 2 Screw the dielectric insert tool into the body and insert the insulator with the plunger.

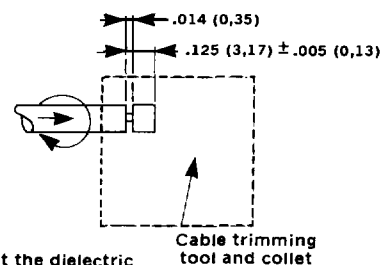

1

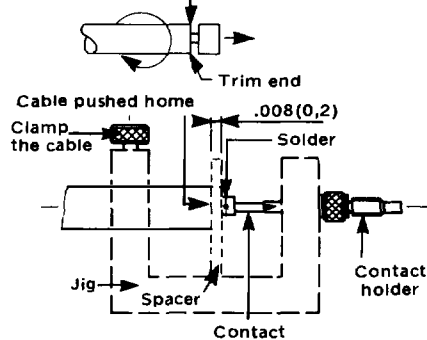

2

3

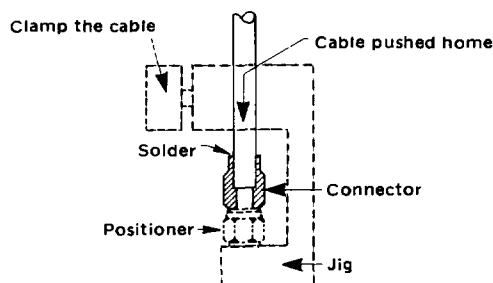

4

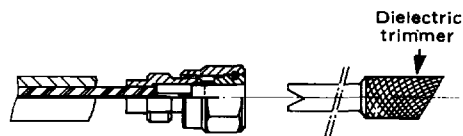

5

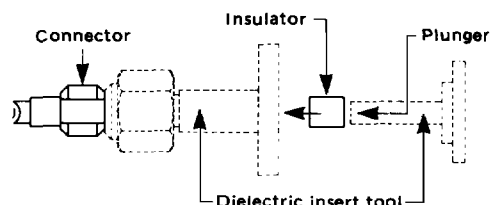

6

MOUNTING INSTRUCTIONS

M 12

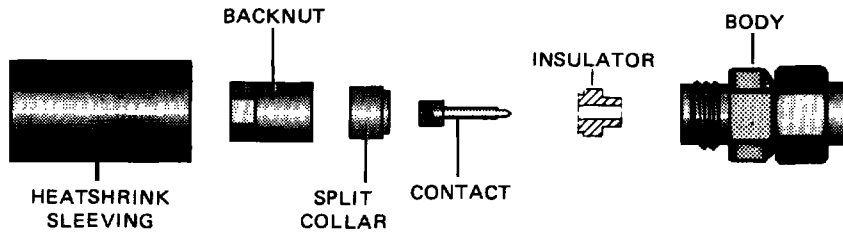

CONNECTORS	TOOLING	
R 125 056 R 125 226	Tool kit R 282 120 cable trimming tool Item 55 cable cutting collet 56 assembly jig 10 contact holder 15	

1

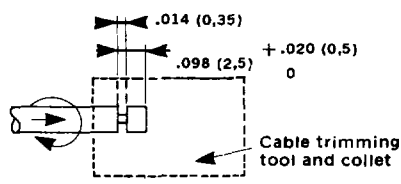

2

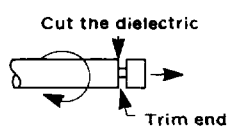

3

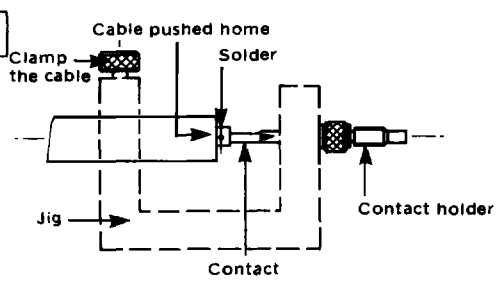

4

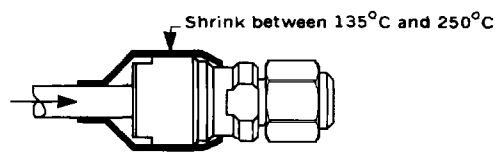

- 1 - 1 Insert the cable into the cable trimming tool and cable cutting collet
- 1 - 2 Saw through cable outer and into dielectric while turning the cable.

- 2 - 1 Cut through the dielectric and bare inner conductor
- 2 - 2 Trim the end of the cable.

- 3 - 1 Place the cable into the assembly jig
- 3 - 2 Position the contact and contact holder as shown
- 3 - 3 Solder the contact.

- 4 - 1 Slide the heatshrink sleeving, backnut and split collar over the sub-assembly
- 4 - 2 Position the insulator over the contact
- 4 - 3 Insert sub-assembly into the body
- 4 - 4 Shrink the heatshrink sleeving over the connector.

Stripline installation

R 125 451
R 125 500
R 125 501

- Insulator : ceramic
- thickness : 0.635 mm
- Dielectric constant : 9.8
- Stripline : gold
- width : 0.635 mm
- Ground plane : gold

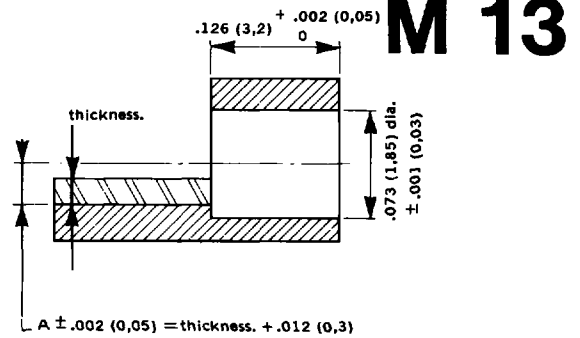

- Ø a -
R 125 462 : 2.2 ± 0.04
R 125 484 : 2.2 ± 0.04
R 125 492 : 2.2 ± 0.04
R 125 512 : 2.2 ± 0.04
R 125 611 001 : 1.45 ± 0.04

- Insulator : ceramic
- thickness : 0.635 mm
- Dielectric constant : 9.8
- Stripline : gold
- width : 0.635 mm
- Ground plane : gold

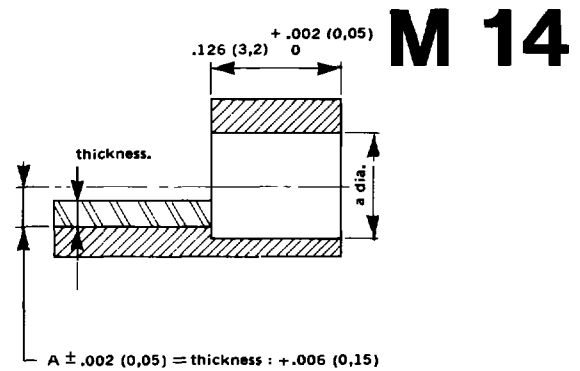

R 125 463
R 125 513

- Insulator : ceramic
- thickness : 0.635 mm
- Dielectric constant : 9.8
- Stripline : gold
- width : 0.635 mm
- Ground plane : gold

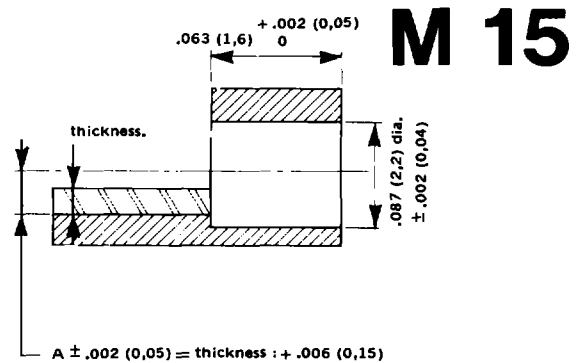

R 125 630
R 125 633

- Insulator : ceramic
- thickness : 0.635 mm
- Dielectric constant : 9.8
- Stripline : gold
- width : 0.635 mm
- Ground plane : gold

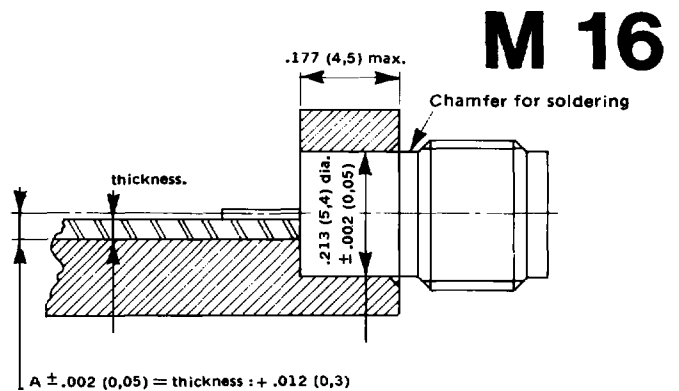

Stripline installation

M 17

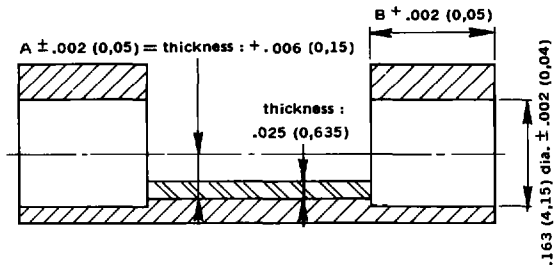

PART NUMBER Dimension B

R 125 612 3,2
R 125 617 3,2

- Insulator : ceramic
- thickness : 0,635 mm
- Dielectric constant : 9,8
- Stripline : gold
- width : 0,635 mm
- Ground plane : gold

M 18

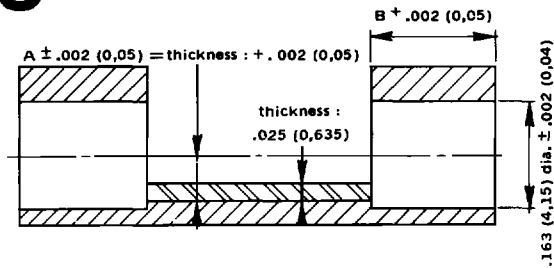

PART NUMBER Dimension B

R 125 622 3,2

- Insulator : ceramic
- thickness : 0,635 mm
- Dielectric constant : 9,8
- Stripline : gold
- width : 0,635 mm
- Ground plane : gold

M 19

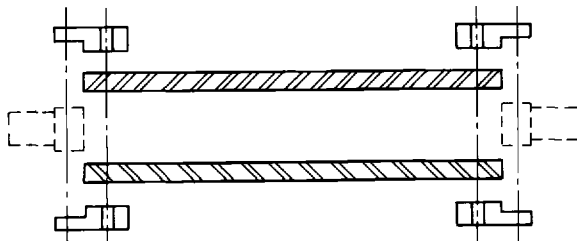

The connectors should be mounted at each end of a copper stripline fitted to a rexolite substrate.

The contacts are held in place under pressure due to the fixing screws on the mounting plates.

Width of stripline	1,12 mm	2,26 mm	4,52 mm
Dielectric constant	2,55	2,55	2,55
Thickness of substrate	0,76 mm	1,52 mm	3,05 mm

R 125 539 R 125 541 R 125 542
R 125 544

M 20

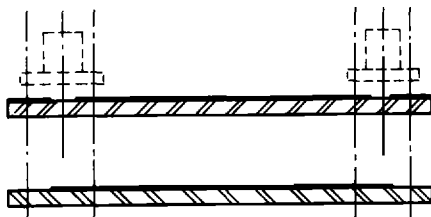

The connectors should be mounted perpendicularly at each end of a copper stripline fitted to a rexolite substrate.

The contacts are held in place by a sandwich clamp method using the connector fixing screws.

Width of stripline	2,26 mm
Dielectric constant	2,55
Thickness of substrate	1,52 mm

R 125 523
R 125 528
R 125 663

N.B. Try to use only 3 fixing screws, if possible in an insulating material, and fix them as far away as possible from the stripline.

M 21

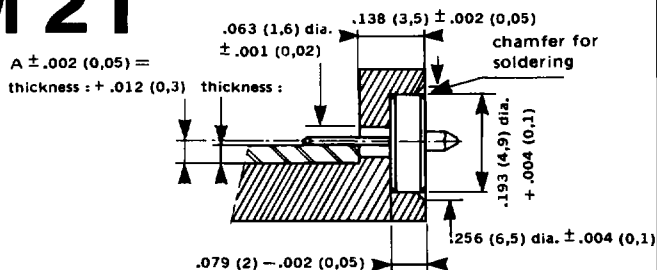

R 280 940

- Insulator : ceramic
- thickness : 0,635 mm
- Dielectric constant : 9,8 mm
- Stripline : gold
- width : 0,635 mm
- Ground plane : gold