

ORIGINAL

TECHNICAL DATA

Page 1 / 2

RIGHT ANGLE PLUG CLAMP TYPE CABLE 2.8/50 + 75S	R142.154.000 SERIES BNC 75
---	---

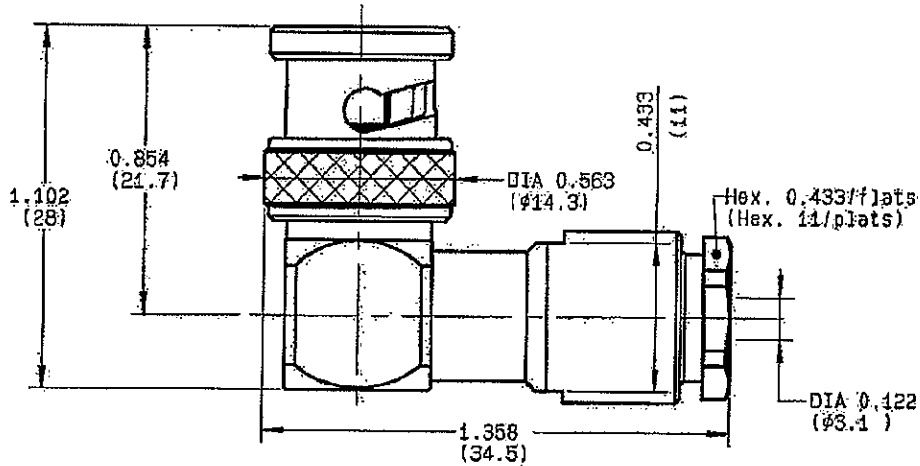

NOMINAL IMPEDANCE	75 Ω	CABLES	KX 22A
FREQUENCY RANGE	0-1.5 GHz		RG 188
TEMPERATURE RATING	-65/+165 °C		RG 316
V.S.W.R	1.65 + 0 x F(GHz) Maxi		RG 179
RF INSERTION LOSS	0.175 \sqrt{F} (GHz) dB Maxi		
VOLTAGE RATING	335 Veff Maxi		
DIELECTRIC WITHSTANDING VOLTAGE	1000 Veff Mini		
INSULATION RESISTANCE	5000 M Ω Mini	OTHERS CHARACTERISTICS	
HERMETIC SEAL	NA Atm.cm ³ /s	CABLE RETENTION	58 N Mini
LEAKAGE (pressurized only)	NA	CENTER CONTACT RETENTION	
MECHANICAL DURABILITY	500 Cycles	Axial force - mating end	27 N Mini
WEIGHT	29.8 gr	Axial force - opposite end	27 N Mini
SPECIFICATION		Torque	NA cm.N Mini
		RECOMMENDED TORQUES	
		Mating	NA cm.N
		Panel nut	NA cm.N
		Clamp nut	450 cm.N

CONNECTOR PARTS	MATERIALS	FINISH	(all values are given in microasters)
BODY	BRASS	NICKEL 2	
OUTER CONTACT			
CENTER CONTACT	BRASS	GOLD 0.5 OVER NICKEL 2	
INSULATOR	PTFE	-	
GASKET	SILICONE RUBBER	-	
OTHERS PIECES	BRASS	NICKEL 2	

ISSUE 0630 H	CREATION DATE	FILE PART-NUMBER	 RADIALL®
------------------------	---------------	------------------	--

The information given here is subject to change without notice. Design changes may be in order to improve the product.

Connect to the future

Y. PERRIN



RADIALL®

R142.154.000

ISSUE **0630 H** SERIES **BNC 75**

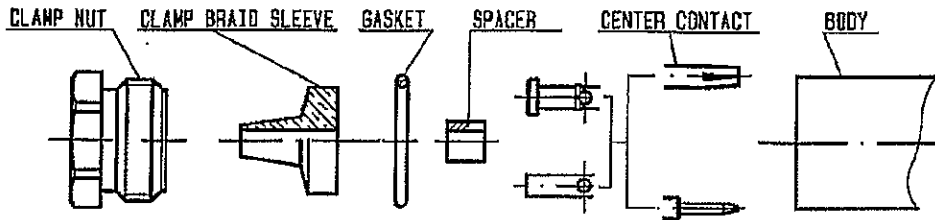

①

Slide clamp nut onto cable .
Strip the cable .
Cut 2 slots in the jacket if necessary .
-

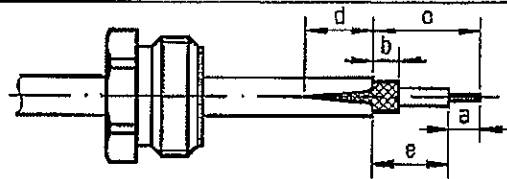

Stripping	a	b	c	d	e
inch	0.157	0.079	0.354	0.079	0.197
mm	4	2	9	2	5

②

Slide the clamp braid sleeve between cable dielectric and braid .
Cut the braid flush with the clamp braid sleeve .
Slide the spacer onto the cable .
-
-
-

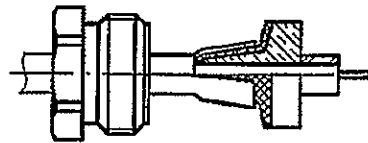

③

Solder center contact onto cable center conductor .
Slide back nut over clamp assembly .
-
-
-
-

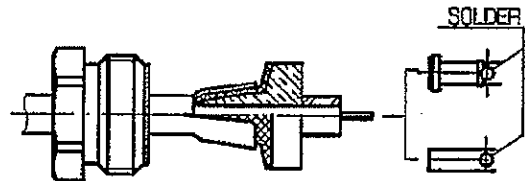

④

Mount gasket into connector .
Screw sub-assembly into the connector body .
(recommended coupling torque 450 N.cm)
39.82 in.lb
-

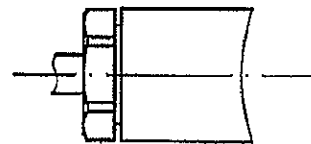

Hex. : 11.00 mm / flats
Hex. : 0.433inch / flats

Y. PERRIN