

**STRAIGHT PLUG CLAMP TYPE
CABLE 14/50 D**

R161.028.000
SERIES N

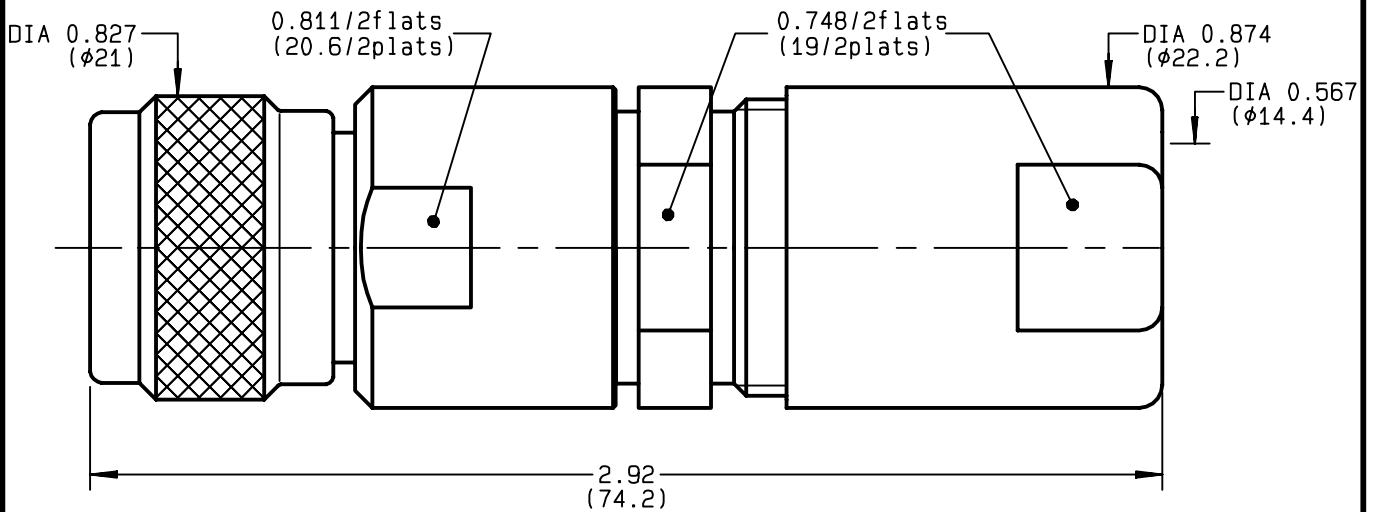

NOMINAL IMPEDANCE	50 Ω	CABLES : RG 217	
FREQUENCY RANGE	0-11 GHz		
TEMPERATURE RATING	-55/+155 °C		
V.S.W.R	1.30 + x F(GHz)Maxi		
RF INSERTION LOSS	0.048 √F(GHz) dB Maxi		
VOLTAGE RATING	1400 Veff Maxi		
DIELECTRIC WITHSTANDING VOLTAGE	2500 Veff Mini		
INSULATION RESISTANCE	5000 MΩMini		OTHERS CHARACTERISTICS
HERMETIC SEAL	NA Atm.cm ³ /s		CABLE RETENTION 400 N Mini
LEAKAGE (pressurized only)	NA		CENTER CONTACT RETENTION
MECHANICAL DURABILITY	500 Cycles	Axial force - mating end NA N Mini	
WEIGHT	95.6 gr	Axial force - opposite end NA N Mini	
SPECIFICATION		Torque NA cm.N Mini	
		RECOMMENDED TORQUES	
		Mating 130 cm.N	
		Panel nut NA cm.N	
		Clamp nut 800 cm.N	

CONNECTOR PARTS	MATERIALS	FINISH	(all values are given) in micrometers
BODY	BRASS	BBR 2	
OUTER CONTACT	BRASS	BBR 2	
CENTER CONTACT	BRASS	GOLD 0.5 OVER NICKEL 2	
INSULATOR	BERYLLIUM COPPER	-	
GASKET	SILICONE RUBBER	-	
OTHERS PIECES	BRASS	BBR 2	

ISSUE	CREATION DATE	FILE PART-NUMBER
9825M00	03/12/1993	EPC 96-07



RADIALL®

BONOMINI

The information given here is subject to change without notice.
Design changes may be in order to improve the product .

Connect to the future



R161.028.000

ISSUE 9825M00 SERIES N

CABLE CLAMP NUT

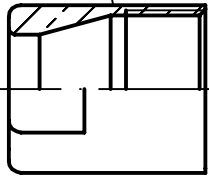

CLAMP NUT

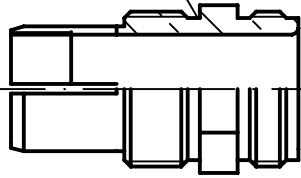

'V' GROOVE GASKET



CLAMP BRAID SLEEVE

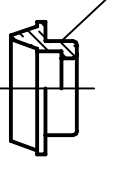

CENTER CONTACT

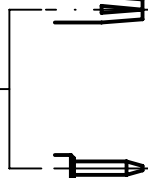

BODY

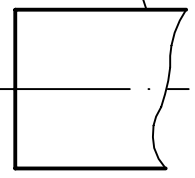

①

Strip the cable .

-
-
-

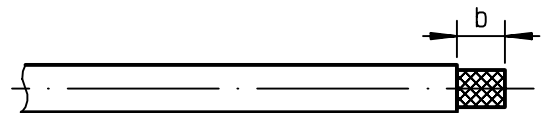

Stripping	a	b	c	d	e
inch	0.197	0.394	0	0	0.039
mm	5	10			1

②

Slide the cable clamp nut, the clamp nut and the 'V' groove gasket onto the cable .
Slide clamp braid sleeve over braid .
Fold back braid and trim off excess of braid .
Trim back dielectric as shown .

-

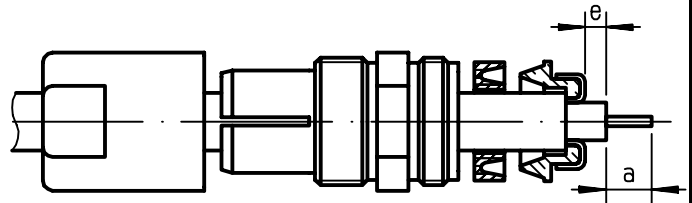

③

Solder the cable inner conductor into centre contact .
Screw sub-assembly without the cable clamp nut into the connector body .
(recommended coupling torque 70.8 in.lb)

-
-

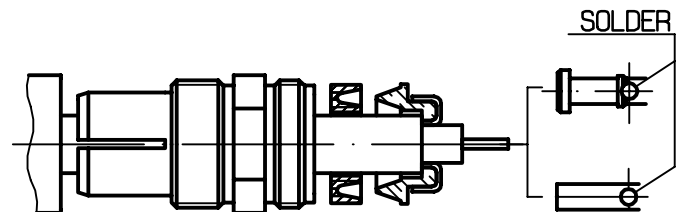

④

Screw the cable clamp nut .
(recommended coupling torque 70.8 in.lb)

-
-

