

RIGHT ANGLE PLUGS, CRIMP TYPE, FOR FLEXIBLE CABLES

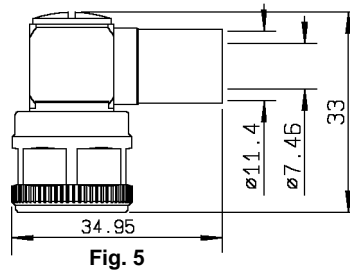

Cable group	Part number	Fig.	Dimensions (mm)				Captured center contact	Assembly instructions	Note
			A	B	C	D			
5 / 50 / S	R161 182 000	1	34.5	28	5.41	3.1	yes	M08	
5 / 50 / D	R161 183 000	1	34.5	28	5.8	3.1	yes	M08	
5 / 50 / D	R161 183 137	4	35	28.3	5.8	3.1	yes	M08	For intermodulation application / tool
10 / 50 / S	R161 184 000	2	37.5		11.05		yes	M08	
10 / 50 / S	R161 185 000	3	42.4	33.2	11.05	7.46	yes	M11	Full crimp
10.3 / 50 / S	R161 184 036	2	46.25		11.05		yes	M08	LMR 400 cable
11 / 50 / D	R161 186 000	2	37.6		11.4		yes	M08	
11 / 50 / D	R161 187 000	3	42.4	33.2	11.4	7.46	yes	M11	Full crimp
11 / 50 / D	R161 186 137	5					yes	M08	For intermodulation application / tool

RIGHT ANGLE PLUGS, CLAMP TYPE, FOR FLEXIBLE CABLES

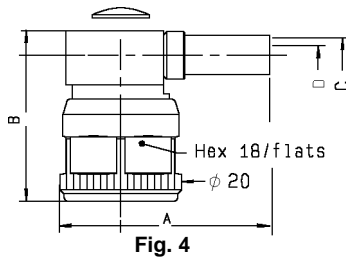
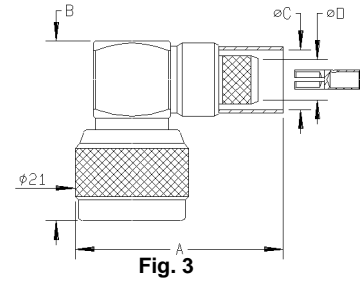
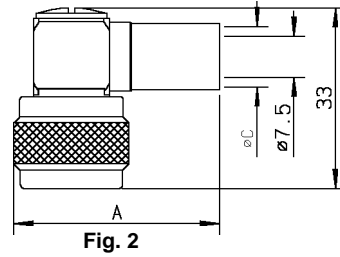
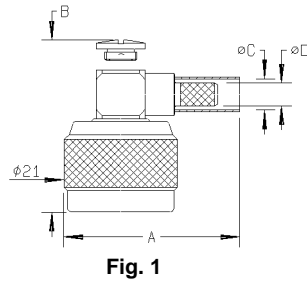
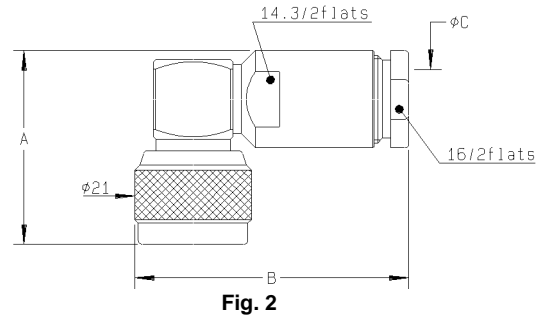
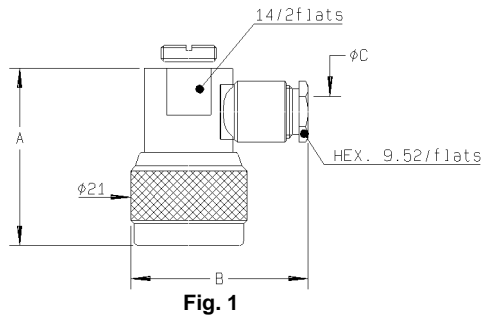

Cable group	Part number	Fig.	Dimensions (mm)			Captured center contact	Assembly instructions
			A	B	C		
5 / 50 / S + D	R161 157 000	1	32	32	5.6	yes	M15
10 + 11 / 50 / S + D	R161 168 000	2	34.85	49.4	11.2	yes	M16