

N / Composite N / N 18 GHz series

R161 / R162 / R163

Pages

Introduction 12-4 to 12-5

N 50Ω and Composite N

Interface 12-6

Characteristics 12-8 to 12-9

ECO N characteristics 12-9

Plugs 12-12 to 12-14

Jacks 12-14 to 12-17

Receptacles 12-18 and 12-20

Composite N receptacle 12-19

Adapters 12-21

Caps 12-22

Accessories 12-22

N 18 GHz

Interface 12-6 to 12-7

Characteristics 12-10

Plugs 12-23

Jacks 12-23

Adapters 12-23

N 75Ω

Interface 12-7

Characteristics 12-11

Plugs 12-24

Jacks 12-24

Receptacles 12-25

Adapters 12-25

Panel drilling 12-26

INTRODUCTION

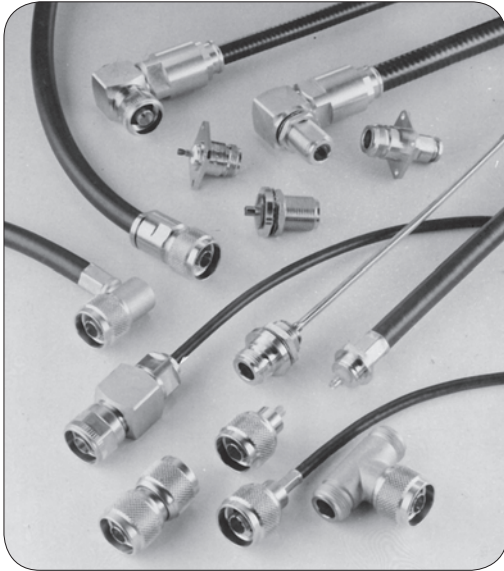

50Ω	DC - 11 GHz (standard N) DC - 18 GHz (N 18 GHz)
75Ω	DC - 1.5 GHz

- | | |
|----------------------------------------------------------------------------------------------------------------------------------------------------------------------------------------------------------------------------------------------------|---------------------------------------------------------------------------------------------------------------------------------------------------------------------------------------------------------------------------------------------------------------|
| <p>GENERAL</p> <ul style="list-style-type: none"> • Standard coaxial connectors • Screw-on coupling • High durability and proven strength • High power rating • Excellent RF performance | <p>APPLICATIONS</p> <ul style="list-style-type: none"> • Wireless communications • Civil and military radio-telecommunication equipment • Countermeasure • Navy equipment • Industrial applications |
|----------------------------------------------------------------------------------------------------------------------------------------------------------------------------------------------------------------------------------------------------|---------------------------------------------------------------------------------------------------------------------------------------------------------------------------------------------------------------------------------------------------------------|

- APPLICABLE STANDARDS**
- MIL-C-39012 / MIL STD 348-304
 - CEI 169-16
 - CECC 22210
 - NF-C-93566
 - DS 8811

NEW
COMPOSITE RECEPTACLES
 Radiall introduces its new composite N receptacles. Composite N connectors offer outstanding electrical performance and are the best compromise in terms of weight, cost and mechanical characteristics to replace existing brass technology.

Features and benefits

- Interchangeable with standard N connectors for backward compatibility
- Evenly distributed contact pressure for a better intermodulation
- Composite material to remove any potential corrosion in outdoor applications
- Color coding, optional
- Light material for weight saving for cost sensitive equipments
- Best material selection for outstanding torque resistance
- Many center contact options available for an easy adaptation to customers application

NEW
POWER SWITCHING CONNECTORS
 It's a "two in one" solution replacing the existing standard RF switches by integrating the switch function into a receptacle connector. This solution provides a unique means of switching between two RF signal paths. As user friendly as a standard connector, the switch is mechanically activated by mating and unmating the connector.

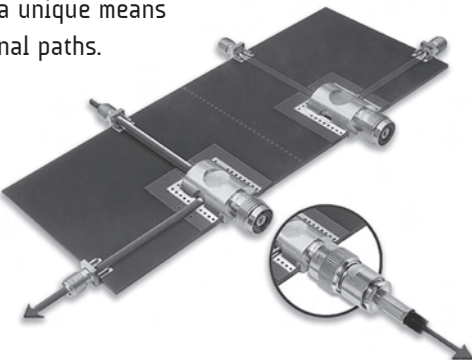

- Main advantages**
- Reliable
 - Increases the density
 - Excellent electrical and mechanical performances
 - Reduction of the cost of ownership
 - Betty RF adaptation
 - Good isolation
 - Available in right or left versions

- Main applications**
- Telecom applications
 - RF power amplifiers

Radiall offers a wide range with a standard plating finish:
BBR (Bright Bronze Radiall) = high performance non magnetic alloy.

• FULL CRIMP MODELS

A fast and reliable attachment system that can be easily achieved in a field environment, with minimum easy-to-use tooling (including models for 2 and 2.6 mm dia cables). All our full crimp connectors are single piece body.

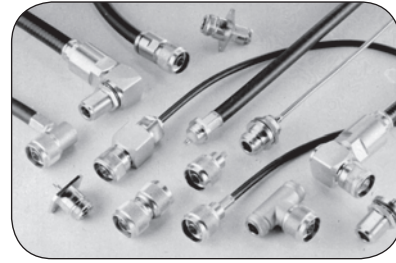

• LOW INTERMODULATION CONNECTORS

Radiall maintains extensive knowledge in this field and has developed N series connectors that are specially designed for base stations of applications where the elimination of intermodulation products is of the utmost importance:

- optimized for 900 - 1800 MHz bands (and able to work up to 11 GHz like the standard models),
- IMP_3 performance = -110 dBm (- 153 dBc),
- new models for corrugated and low loss flexible cables,
- high performance non magnetic materials and platings (silver and BBR),
- new 6 flats coupling nut (18 mm), allowing high coupling torque (170 Ncm) thanks to torque wrench,
- non slotted outer contact.

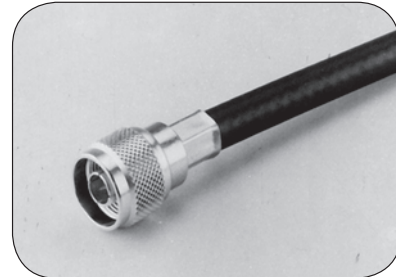

• 18 GHz PRECISION CONNECTORS

Suitable for medium to high power applications and precision microwave test equipment. Long life duration and enhanced electrical performance in severe environmental conditions. N18 series mate with all 50 ohms N connectors.

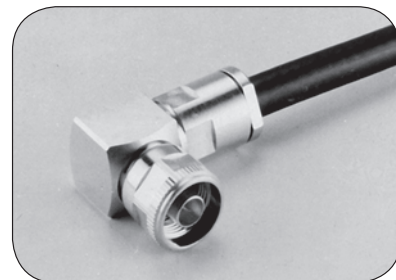

• VERY LOW INTERMODULATION CABLE ASSEMBLIES

For severe intermodulation conditions, we propose a range of low intermodulation cable assemblies $IMP_3 \leq 125$ dBm.

For further details, please read our:

- Intermodulation application guide (D1 032 DE)
- BBR plating application guide (D1 030 DE)

IMPORTANT: the 50 Ω and the 75 Ω connectors are **NOT INTERMATEABLE**, resulting in the interface destruction.

INTERFACE N 50Ω

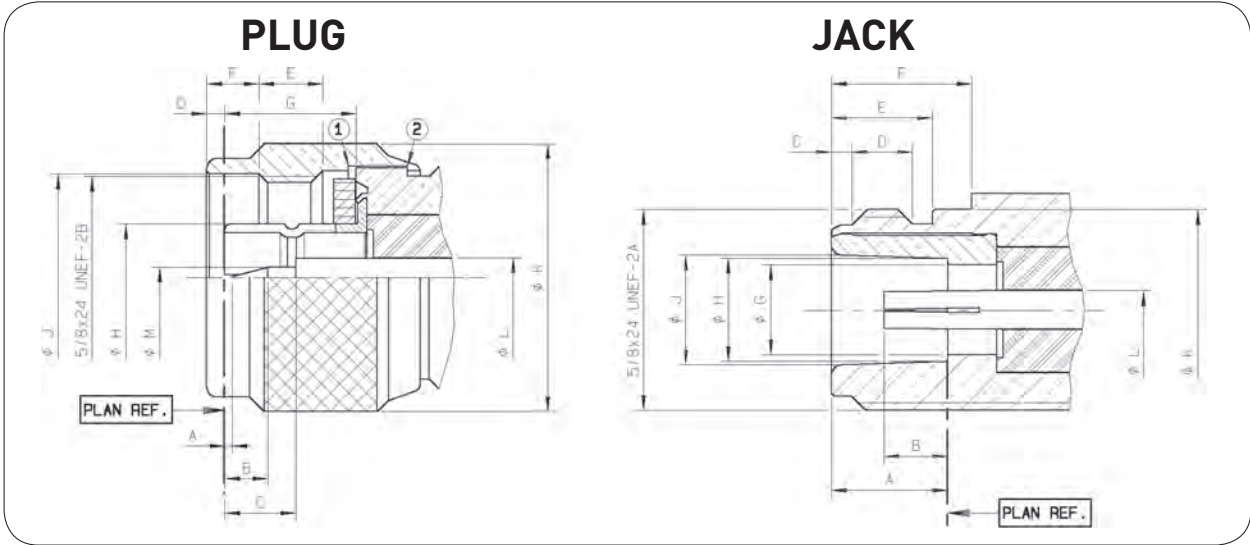

LETTER	mm		inch	
	min.	max.	min.	max.
A	0.13	1.03	.005	.13
B	2.80	3.56	.110	.140
C	5.33	5.83	.210	.229
D	1	2	.016	.066
E	4.54	5.39	.179	.212
F	4.05	4.20	.159	.165
G	10.23	10.43	.403	.411
H DIA	8.27	8.37	.326	.329
J DIA	16.1	16.2	.634	.638
K DIA	20.9	21	.823	.827
L DIA	3.01	3.05	.118	.120
M DIA	1.63	1.67	.064	.066

LETTER	mm		inch	
	min.	max.	min.	max.
A	9.05	9.19	.356	.362
B	4.75	5.25	.187	.207
C	1.20	1.95	.047	.077
D	4.4	5.1	.173	.201
E	6.8	9	.268	.354
F	10.9	11.2	.429	.441
G DIA	6.98	7.02	.275	.276
H DIA	8.03	8.13	.316	.320
J DIA	8.53	8.73	.336	.344
K DIA	15.65	15.85	.616	.624
L DIA	3.01	3.05	.118	.120

INTERFACE N 18 GHz



IMPORTANT: the 50Ω and the 75Ω connectors are NOT INTERMATEABLE, resulting in the interface destruction.

INTERFACE N 18 GHz

N 18 GHz/N 75Ω

LETTER	mm	inch
	0.29	.0114
	1.25	.049
	3.02	.1189
	3.06	.1204
	4.00	.157
	4.20	.165
	4.50	.177
	5.00	.197
	5.28	.208
	5.40	.2126
	6.98	.2748
	7.02	.2764
	8.00	.315
	8.02	.316
	10.60	.417
	10.76	.423
	16.30	.642
	16.40	.646
	18.80	.740
	19.00	.748

LETTER	mm	inch
	0.51	.020
	1.01	.0397
	1.20	.0472
	1.95	.0767
	3.02	.1189
	3.06	.1204
	4.60	.1811
	5.10	.201
	5.14	.202
	5.26	.207
	6.98	.2748
	7.02	.2764
	8.05	.317
	8.10	.319
	8.53	.336
	8.73	.3437
	9.07	.357
	9.17	.361
	11.23	.442
	15.85	.624

Mating dimensions are MIL-C-39012 nominal with tighter tolerances and solid outer contact.

INTERFACE N 75Ω

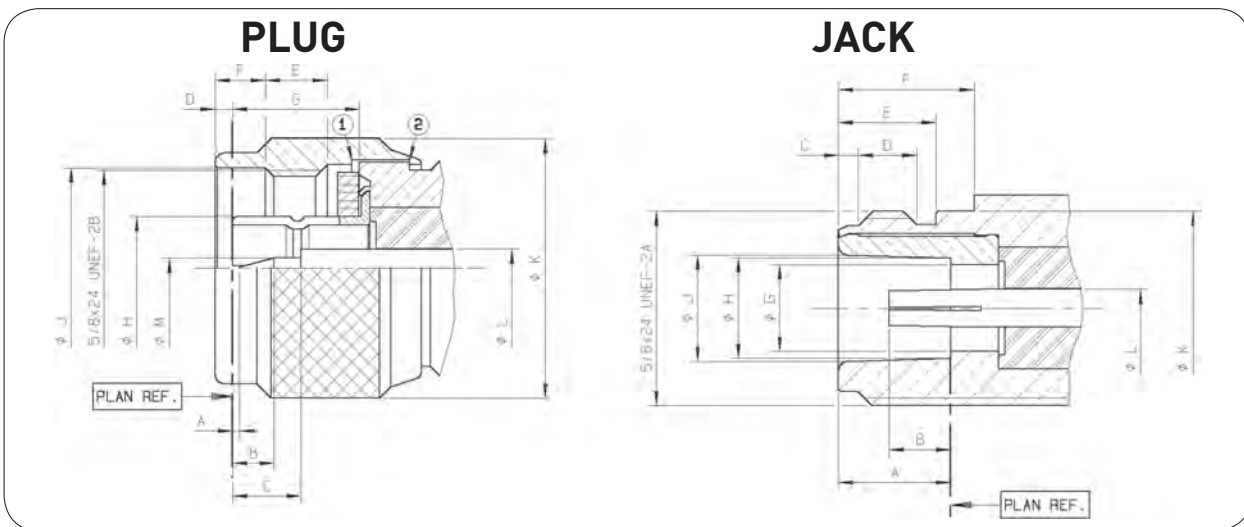

LETTER	mm		inch	
	min.	max.	min.	max.
A	0.13	1.03	.005	.13
B	2.80	3.56	.110	.140
C	5.33	5.83	.210	.230
D	1	2	.016	.066
E	4.54	5.39	.179	.212
F	4.05	4.20	.159	.165
G	10.23	10.43	.403	.411
H DIA	8.27	8.37	.326	.329
J DIA	16.1	16.2	.634	.638
K DIA	20.9	21	.823	.827
L DIA	1.96	2	.077	.079
M DIA	0.87	0.91	.034	.036

LETTER	mm		inch	
	min.	max.	min.	max.
A	9.05	9.19	.356	.362
B	4.75	5.25	.187	.207
C	1.20	1.95	.047	.077
D	4.4	5.1	.173	.201
E	6.8	9	.268	.354
F	10.9	11.2	.429	.441
G DIA	6.98	7.02	.275	.276
H DIA	8.03	8.13	.316	.320
J DIA	8.53	8.73	.336	.344
K DIA	15.65	15.85	.616	.624
L DIA	1.96	2	.077	.079

IMPORTANT: the 50Ω and the 75Ω connectors are **NOT INTERMATEABLE**, resulting in the interface destruction.

*statistics dimensions: .0539 .0055 (.0594 max)/(1.37 0.14)(1.51 max)

- 1) Coupling nut against on datum 1
- 2) Coupling nut against on datum 2

CHARACTERISTICS

Test/characteristics	Standard reference	Values/remarks
----------------------	--------------------	----------------

ELECTRICAL CHARACTERISTICS

Impedance		50Ω			
Frequency range		DC - 11 GHz			
Typical V.S.W.R. straight models cable group: .085" .141" .250" 5/S+5/D 10/S+11/D right angle models: 5/S+D 10/S+11/D	Frequency	1 GHz	2.5 GHz	5 GHz	11 GHz
		1.03	1.03	1.05	1.08
		1.03	1.05	1.05	1.08
		1.03	1.03	1.05	1.07
		1.05	1.06	1.1	1.16
		1.04	1.05	1.09	1.2
		1.04	1.05	1.18	
		1.04	1.1	1.20	
Intermodulation product (IMP ₃) • Standard connectors • Intermodulation connectors • Home made intermodulation cable assemblies		- 90 dBm typ. (- 133 dBc typ. / 20W) - 110 dBm typ. (- 153 dBc typ. / 20W) - 125 dBm typ. (- 165 dBc typ. / 20W)			
Insertion loss	straight connector right-angle connector	MIL	< 0.15 dB max at 10 GHz ~ < 0.05 vF (GHz) < 0.15 dB max at 10 GHz ~ < 0.1 vF (GHz)		
RF Leakage		MIL	-90 dB min from 2 to 3 GHz (interface)		
Insulation resistance		MIL	5000 MΩ min		
Contact resistance	center contact outer contact	MIL	Initial 1 mΩ 0.2 mΩ	After tests 1.5 mΩ -	
Working voltage in VRMS at sea level (at 70, 000 feet)		CECC	Cable 5/50: 850 (250) Cable .085"/.141": 350 (250) Cable 10+11/50: 1400 (400) Cable LMR 400/600: 1400 (400) Cable .250": 1400 (400)		
Dielectric withstanding voltage in VRMS at sea level (at 70, 000 feet)		CECC	Cable 5/50: 1500 (350) Cable .085"/.141": 1000 (350) Cable 10/50: 2500 (600) Cable LMR 400/600: 2500 (600) Cable .250": 2500 (600)		
RF testing voltage	sea level	CECC	1500 VRMS (5 MHz sine wave)		

MECHANICAL CHARACTERISTICS

Durability		CECC	500 matings	
Engagement and separation torque		CECC	6.6 Ncm max (.58 Inch-pounds)	
Recommended coupling nut torque			40 to 60 Ncm (manual) 130 Ncm (11.45 inch pounds) (with pliers R 282 202 000) 170 Ncm (14.96 inch pounds) (with torque wrench R 282 303 020)	
Proof torque		CECC	170 Ncm (14.96 inch pounds)	
Coupling nut retention force		CECC	450 N (101.25 Lbs)	
Cable retention force		CECC	Cable 5/50/S 150 N (33.75 Lbs) Cable 5/50/D 200 N (48 Lbs) Cable 10/50 300 N (67.5 Lbs) Cable 11/50 400 N (90 Lbs) Cable .141" 270 N (60.75 Lbs)	
Center contact retention force	axial	MIL	27 N (6.08 Lbs) cables < ∅ 8 mm 68 N (15.30 Lbs) cables > ∅ 8 mm	

Standard packaging = 50 pieces.

Test/characteristics	Standard reference	Values/remarks
----------------------	--------------------	----------------

ENVIRONMENTAL CHARACTERISTICS

Temperature range	standard models semi-rigid cables	CECC	- 55°C + 155°C - 55°C + 105°C
Thermo cycling test		CECC	- 55°C/+ 155°C/21 j
Thermal shock		CECC	- 40°C/+ 155°C or - 40°C/+ 85°C - 5 cycles
High temperature test		CECC	125°C/1000 H
Corrosion salt spray		CECC	48 H
Vibration		CECC	Sinus 10g/10 - 500 Hz
Shock		CECC	1/2 Sinus 50g/11 ms
Moisture resistance clamp type crimp type		IEC 529	IP 67 IP 65 (with heatshrink sleeve)
Hermetic test		CECC	10 ⁻⁵ bar. cm ³ /s
Leakage		CECC	Differential pressure 100 to 110 KPa: 1 bar cm ³ / H

MATERIALS

Body / nut / center male contact / outer contact	Brass
Center female contact	Treated beryllium copper
Ferrule	Brass
Insulator	PTFE
Gasket	Silicon elastomer

PLATING

	Standard	Intermodulation models + COAXI-KIT
Body crimp + clamp type solder type	BBR Gold	Silver + BBR Silver
Coupling nut/Design	BBR/cross knurled	BBR/hex.
Center contacts	Gold	Silver
Outer contacts/Design	BBR/slotted	Silver + BBR/non slotted

CHARACTERISTICS ECO N

ELECTRICAL AND MECHANICAL CHARACTERISTICS

Impedance	50Ω
Frequency range	DC - 6 GHz
Typical VSWR (straight models)	1.2 at 6 GHz
Temperature range	- 40°C/+ 85°C
Durability	100 mating cycles

MATERIALS AND PLATING

Component	Materials	Platings
Connector body	Brass	BBR
Insulator	PTFE / Polypropylene	
Female center contact	Bronze	Center contact Gold 0.1 μm (typical)
Outer contact	Brass	BBR

PACKAGING

Packaging ⁽¹⁾	50 pieces bulk Unit packaging
--------------------------	----------------------------------

⁽¹⁾ MOQ = Minimum Order Quantity

Some connectors may feature different performances depending on the application they have been designed for, or according to the applicable cable.

CHARACTERISTICS

Test/characteristics	Values/remarks	
ELECTRICAL CHARACTERISTICS		
Impedance	50Ω	
Frequency range	DC - 18 GHz	
Typical V.S.W.R.	With SHF cables	
straight connector	1.10 at 18 GHz	
right angle connector	1.15 at 18 GHz	
Insertion loss	< 0.1 √F (GHz) dB	
RF Leakage	- 90 dB (2 to 3 GHz)	
Insulation resistance	5000 MΩ min	
Contact resistance	After environment test	Initial
outer contact	2 mΩ max	1.5 mΩ max
inner contact	N.A.	2 mΩ max
Peak power (at sea level)	5000 W	
Average power (at sea level, 25°C)	2000 W at 0.1 GHz 600 W at 1 GHz 150 W at 10 GHz	
	.085" semi-rigid cable	.141" semi-rigid cable
Dielectric withstanding voltage		
at sea level	1000 Vrms	1500 Vrms
at 70 000 feet	250 Vrms	375 Vrms
Voltage rating		
at sea level	335 Vrms	500 Vrms
at 70 000 feet	85 Vrms	125 Vrms
RF high potential withstanding voltage	670 Vrms	1000 Vrms
Corona level	250 Vrms	375 Vrms

MECHANICAL CHARACTERISTICS

Durability	500 matings	
Cable retention force	136 N (31 lbf)	272 N (61 lbf)
Recommended coupling torque	160 Ncm (14 lbf.in)	
Contact captivation	27 Ncm (6 lbf) min	

ENVIRONMENTAL CHARACTERISTICS

Temperature range	Standard connectors - 65°C + 165°C	Connectors for semi-rigid cable - 40°C + 125°C
Vibration	MIL-STD-1344 Method 2005 Condition 4	
Shock	MIL-STD-1344 Method 2004 Condition G	
Thermal shock	MIL-STD-1344 Method 1003 Condition A	
Corrosion (salt mist)	MIL-STD-1344 Method 1001 Condition B	
High temperature test	CECC 22000/4.7.2	
Damp heat	CECC 22000/4.6.6	
Low pressure immersion	EN2591 AECMA TestC14	
Resistance to fluids contamination	EN2591 AECMA TestC15	

MATERIALS

Body	Stainless steel
Center contact	Beryllium copper and brass
Coupling nut	Brass
Insulator	PTFE or polyetherimid resin
Gasket	Fluorosilicon or fluorocarbon

PLATING

Body	Passivated
Center contact	Gold
Coupling nut	Nickel

Test/characteristics	Standard reference	Values/remarks
----------------------	--------------------	----------------

ELECTRICAL CHARACTERISTICS

Impedance		75Ω
Frequency range		DC - 1.5 GHz
Typical V.S.W.R.	Cable 6/75 Cable 10+11/75	1.06 1.10
Insertion loss	straight connector right-angle connector	MIL < 0.15 dB
RF Leakage		MIL - 90 dB min at 1 GHz
Insulation resistance		MIL 5000 MΩ min
Contact resistance	center contact outer contact	MIL Initial 1 mΩ 0.2 mΩ After tests 1.5 mΩ -
Working voltage in VRMS at sea level (at 70 000 feet)	CECC	Cable 10+11/75: 1400 (400) Cable 6/75: 850 (250)
Dielectric withstanding voltage in VRMS at sea level (at 70 000 feet)	CECC	Cable 10+11/75: 2500 (600) Cable 6/75: 1500 (350)
RF testing voltage	sea level	CECC 1500 VRMS (5 MHz sine wave)

MECHANICAL CHARACTERISTICS

Durability	CECC	500 matings
Engagement and separation torque	CECC	6.6 Ncm max (.58 Inch-pounds)
Recommended coupling nut torque	CECC	40 to 60 Ncm (manual) 130 Ncm (11.45 inch pounds) (with pliers R282 202 000)
Proof torque	CECC	170 Ncm (14.96 inch pounds)
Coupling nut retention force	CECC	450 N (101.25 Lbs)
Cable retention force	cable 6/75 cable 10+11/75	CECC 200 N 300 N
Center contact retention force	axial	MIL 27 N (6.08 Lbs)

ENVIRONMENTAL CHARACTERISTICS

Temperature range	CECC	- 55°C + 155°C
Thermo cycling test	CECC	- 55°C / + 155°C / 21 j
Thermal shock	CECC	- 40°C / + 155°C or - 40°C / + 85°C - 5 cycles
Hight temperature test	CECC	125°C / 1000 H
Corrosion salt spray	CECC	48 H
Vibration	CECC	Sinus 10 g / 10 - 500 Hz
Shock	CECC	1/2 Sinus 50g / 11 ms
Moisture resistance clamp type crimp type	IEC 529	IP 67 IP 65 (with heatshrink sleeve)
Hermetic test	CECC	10-5 bar. cm ³ /s
Leakage	CECC	Differential pressure 100 to 110 KPa: 1 bar cm ³ / H

MATERIALS

Body (nut)/center male contact/outer contact	Brass
Center female contact	Treated beryllium copper
Ferrule	Brass
Insulator	PTFE
Gasket	Silicon elastomer

PLATING

Body	BBR
Coupling nut/design	BBR/cross knurled
Center contact	Gold
Outer contact/design	BBR/slotted

Standard packaging = 50 pieces.

PLUGS

STRAIGHT PLUGS, FULL CRIMP TYPE, FOR FLEXIBLE CABLES

(single piece body)

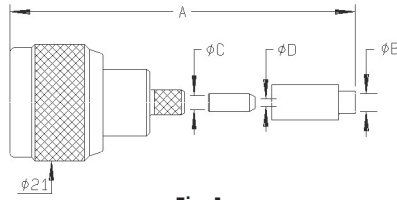

Fig. 1

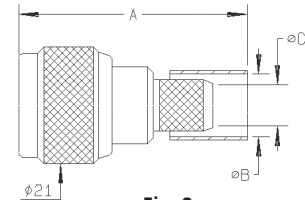

Fig. 2

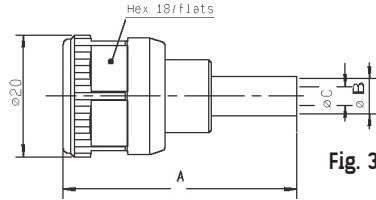

Fig. 3

Cable group	Cable group dia.	Part number	Fig.	Dimensions (mm)				Captive center contact	Note
				A	B dia.	C dia.	D dia.		
RG174/RG316/RD316	2.6/50/S+D	R161 072 000	1	39.7	3.25	3.38	1.63	yes	
RG58/R141	5/50/S	R161 082 000	2	38.5	5.41	3.11	7.46	yes	
		R161A 082 000						yes	ECO version
RG142/RG223/RG400	5/50/D	R161 083 000	2	30.5	5.8	3.11	7.46	yes	
		R161A 083 000						yes	ECO version
RG213	10/50/S	R161 075 000	2	40.2	11.05	3.11	7.46	yes	
		R161A 075 000		37.2				yes	ECO version
	10.3/50/S	R161 075 060	2	40.2	11.05	3.11	7.46	yes	LMR 400 cable
RG214	11/50/D	R161 088 000	2	37	11.4	3.11	7.46	yes	
		R161A 088 000						yes	ECO version
		R161 088 137	3	40.2	11.4	3.11	7.46	yes	For intermodulation application tool

STRAIGHT PLUGS, CLAMP TYPE, FOR FLEXIBLE CABLES

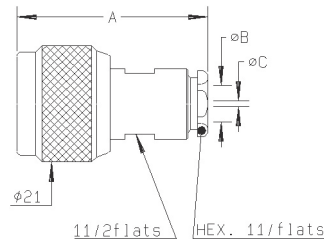

Fig. 1

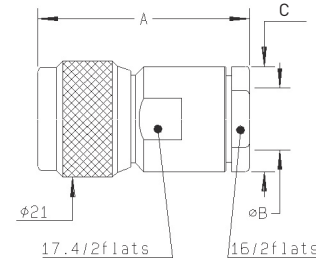

Fig. 2

Cable group	Cable group dia.	Part number	Fig.	Dimensions (mm)			Captive center contact
				A	B dia.	C dia.	
RG174/RG316/RD316	2.6/50/S+D	R161 004 000	1	33.9	3.1	1.7	yes
RG58/RG141/RG142/RG223/RG400	5/50/S+D	R161 006 000		34.4	5.6		no
RG59/RG62/RG71	6/75+93	R161 010 000		34.9	5.6		yes
		R161 012 000		34.4	6.6		
RG213/RG393/RG11/RG12/RG144/RG214/RG216	10+11/50+75	R161 018 000	2	44	11.2	17.5	
		R161 020 000		38.1	11.2	17.5	no
		R161 022 000		38.9	11.2	19	yes
RG217	14/50/D	R161 027 000		40.9	14.4	22.2	

STRAIGHT PLUGS, FOR SEMI-RIGID CABLES

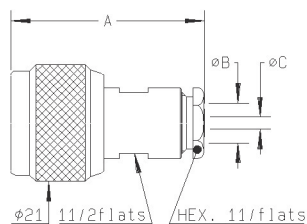

Fig. 1

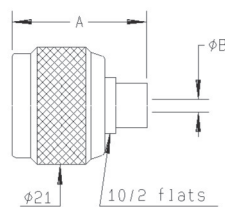

Fig. 2

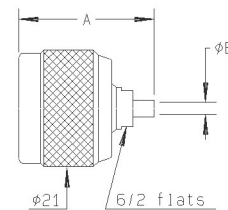

Fig. 3

Cable group	Cable group dia.	Part number	Fig.	Dimensions (mm)			Captive center contact	Note
				A	B dia.	C dia.		
RG405	.085"	R161 050 300	3	24.4	2.25		no	Solder type
RG402	.141"	R161 051 000			3.65			Solder type
		R161 052 000	1	35	5.6	3.65		Clamp type
RG401	.250"	R161 053 000	1	35.4	6.6			Clamp type
		R161 054 000	2	24.4	6.45		Solder type	

RIGHT ANGLE PLUGS, CRIMP TYPE, FOR FLEXIBLE CABLES

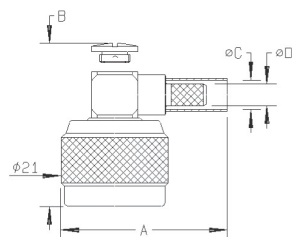
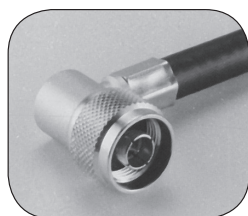

Fig. 1

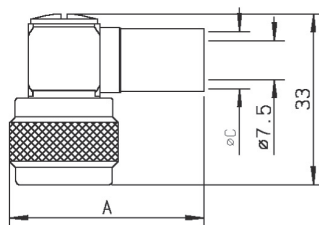

Fig. 2

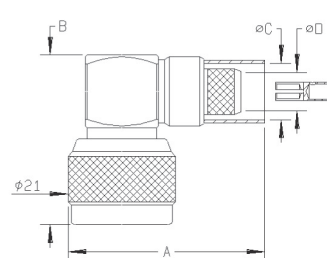

Fig. 3

Cable group	Cable group dia.	Part number	Fig.	Dimensions (mm)				Captive center contact	Note
				A	B	C dia.	D dia.		
RG174/RG316	2.6/50/S	R161 181 000	1	29.5	26.3				
RG58/RG141	5/50/S	R161 182 000		28	5.41	3.1	yes		
		R161A 182 000		28.5				ECO version	
RG142/RG223/RG400	5/50/D	R161 183 000	28	5.8				yes	
		R161A 183 000				ECO version			
RG223	10/50/S	R161A 184 000	1	32.8	35.2		7.4		
		R161 185 000	3	42.4	33.2	11.05	7.46	yes	Full crimp
RG214	11/50/D	R161 186 000	2	37.6		11.4			
		R161A 186 000		33					ECO version
		R161 187 000	3	42.4	33.2	11.4	7.46	yes	Full crimp

To download data sheets and assembly instructions, visit www.radiall.com & enter the part number in the Search box. **Bold** part numbers represent products typically in stock & available for immediate shipment. See page 8 and 9 for packaging information.

PLUGS AND JACKS

RIGHT ANGLE PLUGS, CLAMP TYPE, FOR FLEXIBLE CABLES

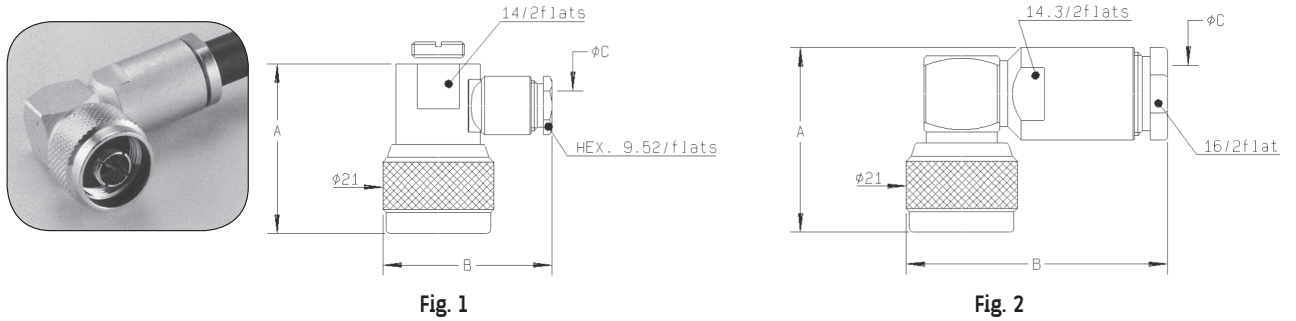

Cable group	Cable group dia.	Part number	Fig.	Dimensions (mm)			Captive center contact
				A	B	C dia.	
RG223/RG142/RG223/RG400	5/50/S+D	R161 157 000	1	32	32	5.6	yes
RG213/RG393/RG214	10+11/50/S+D	R161 168 000	2	34.85	49.4	11.2	yes

RIGHT ANGLE PLUG, SOLDER TYPE, FOR SEMI-RIGID CABLES

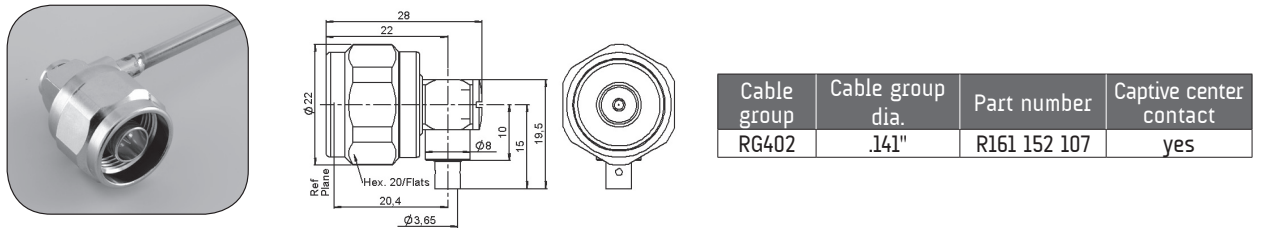

Cable group	Cable group dia.	Part number	Captive center contact
RG402	.141"	R161 152 107	yes

STRAIGHT JACKS, FULL CRIMP TYPE, FOR FLEXIBLE CABLES

(single piece body)

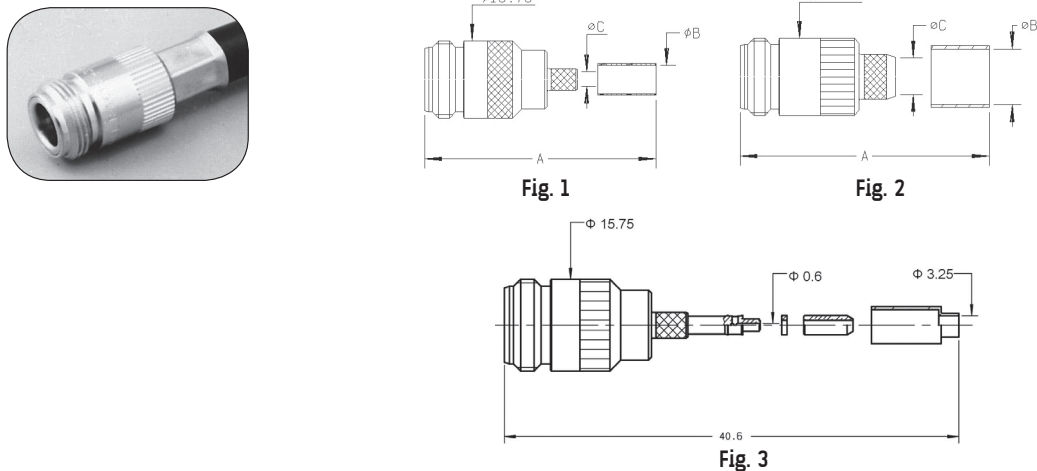

Cable group	Cable group dia.	Part number	Fig.	Dimensions (mm)			Captive center contact
				A	B dia.	C dia.	
RG174/RG216/RD316	2.6/50/S+D	R161 236 000	3				yes
RG58/RG141	5/50/S	R161 237 000	1	39.3	5.41	3.11	
RG142/RG223/RG400	5/50/D	R161 238 000	2	40.6	5.8	7.46	
RG223	10/50/S	R161 241 000			11.05		
RG214	11/50/D	R161 243 000			11.4		

To download data sheets and assembly instructions, visit www.radiall.com & enter the part number in the Search box. **Bold** part numbers represent products typically in stock & available for immediate shipment. See page 8 and 9 for packaging information.

STRAIGHT JACKS, CLAMP TYPE, FOR FLEXIBLE CABLES

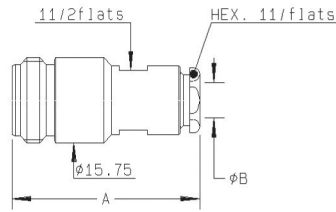

Fig. 1

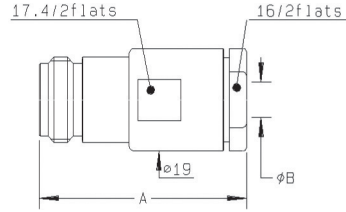

Fig. 2

Cable group	Cable group dia.	Part number	Fig.	Dimensions (mm)		Captive center contact
				A	B dia.	
RG223/RG142/RG223/RG400	5/50/S+D	R161 206 000	1	35.3	5.6	yes
RG213/RG393/RG214	10+11/50/S+D	R161 220 000	2	39.3	11.2	yes

STRAIGHT JACKS

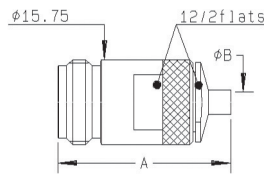

Fig. 1

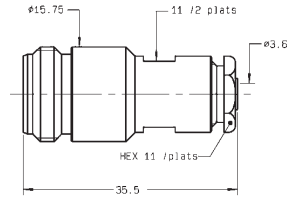
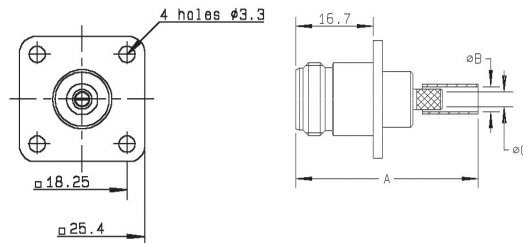
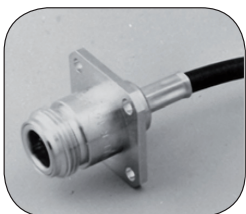

Fig. 2

Cable group	Cable group dia.	Part number	Fig.	Dimensions (mm)		Captive center contact	Note
				A	B dia.		
RG402	.141"	R161 226 020	1	32	3.65	no	Solder type
		R161 227 000	2				Clamp type

SQUARE FLANGE, STRAIGHT JACKS, FULL CRIMP TYPE, FOR FLEXIBLE CABLES (single piece body)



Cable group	Cable group dia.	Part number	Dimensions (mm)			Captive center contact	Panel drilling
			A	B dia.	C dia.		
RG178	2/50/S+D	R161 281 000	40.3	2.35	1		P01
RG174/RG316/RD176	2.6/50/S+D	R161 281 300	40.3	3.25	1.63		
RG58/RG141	5/50/S	R161 282 000	39.3	5.41			
RG142/RG223/RG400/RG213	5/50/D	R161 283 000	39.3	5.8	3.11	yes	
RG213	10/50/S	R161 286 000	40.6	11.05	7.46	yes	

To download data sheets and assembly instructions, visit www.radiall.com & enter the part number in the Search box. Bold part numbers represent products typically in stock & available for immediate shipment. See page 8 and 9 for packaging information.

JACKS

SQUARE FLANGE, STRAIGHT JACKS

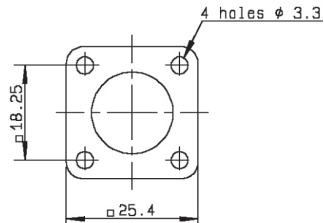

Fig. 1 and 2

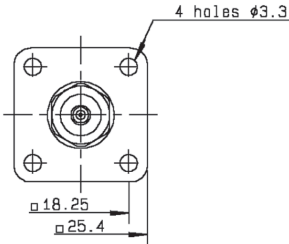

Fig. 3 and 4

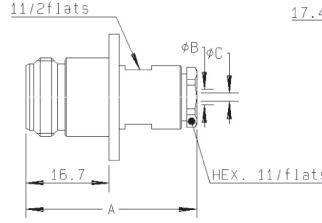

Fig. 1

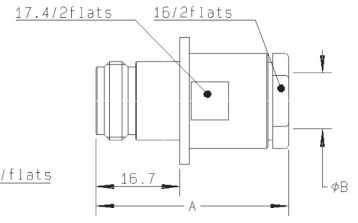

Fig. 2

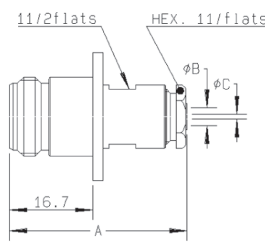

Fig. 3

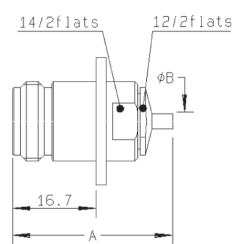

Fig. 4

Cable group	Cable group dia.	Part number	Fig.	Dimensions (mm)			Captive center contact	Panel drilling	Note
				A	B dia.	C dia.			
RG174/RG316/RD316	2.6/50/S + D	R161 252 000	1	34.3	3.1	1.7	yes	P01	Clamp type
RG58/RG141/RG142/RG223/RG400	5/50/S + D	R161 256 000		35.4	5.6				
RG213/RG393/RG214	10 + 11/50/S + D	R161 270 000	2	39.3	11.2		no	P01	Solder type Clamp type
RG402	.141"	R161 277 000	3	35.5	5.6	3.65			
		R161 277 300	4	32	3.65				
RG401	.250"	R161 278 000	3	35.9	6.6				

BULKHEAD STRAIGHT JACKS, FULL CRIMP TYPE, FOR FLEXIBLE CABLES (panel sealed) (single piece body)

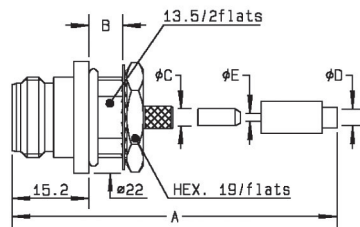

Fig. 1

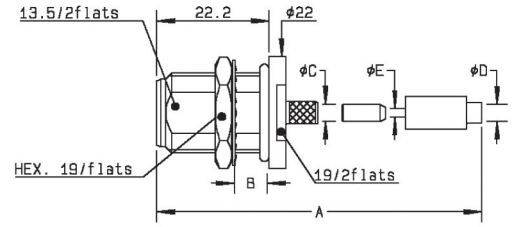

Fig. 2

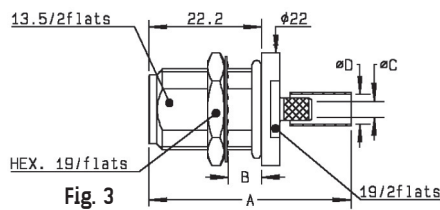

Fig. 3

Cable group	Cable group dia.	Part number	Fig.	Dimensions (mm)					Captive center contact	Panel drilling	Note
				A	B	C dia.	D dia.	E dia.			
RG174/RG316/RD316	2.6/50/S+D	R161 311 200	1	40.4	6.5	3.38	3.25	1.63	yes	P14	Front mount
		R161 311 300	2								
RG58/RG141	5/50/S	R161 329 000	3	39.8	6.5	3.11	5.41	Rear mount			
RG142/RG223/RG400	5/50/D	R161 329 200					5.8				
RG214	11/50D	R161 331 200	3	40.6	6.5	7.46	11.4				

To download data sheets and assembly instructions, visit www.radiall.com & enter the part number in the Search box. **Bold** part numbers represent products typically in stock & available for immediate shipment. See page 8 and 9 for packaging information.

BULKHEAD STRAIGHT JACKS, CLAMP TYPE, FOR FLEXIBLE CABLES (panel sealed)

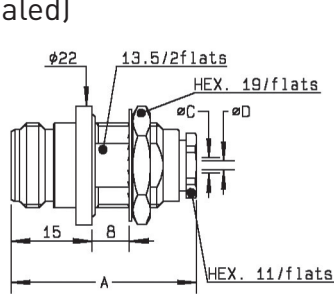

Fig. 1

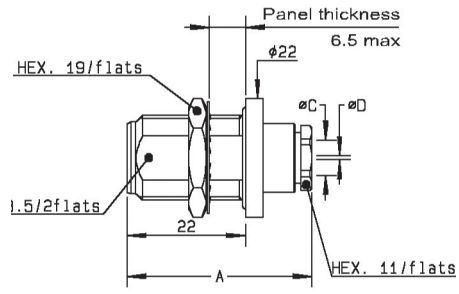

Fig. 2

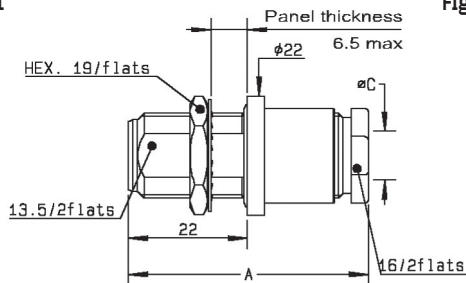

Fig. 3

Cable group	Cable group dia.	Part number	Fig.	Dimensions (mm)			Captive center contact	Panel drilling	Note
				A	C dia	D dia			
RG174/RG316/RD316	2.6/50/S+D	R161 321 000	1	34.3	3.1	1.7	yes	P14	Front mount
		R161 322 000	2						Rear mount
RG58/RG141/RG142/RG223/RG400	5/50/S+D	R161 325 000	2	35.4	5.6				Rear mount
RG213/RG393/RG214	10+11/50/S+D	R161 332 000	3	43	11.2	no			

BULKHEAD STRAIGHT JACKS, FOR SEMI-RIGID CABLES (panel sealed)

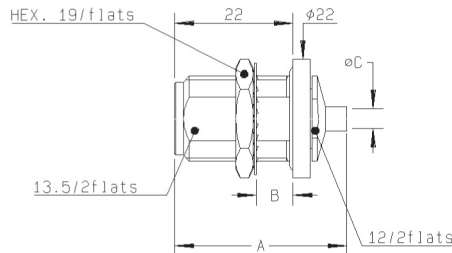
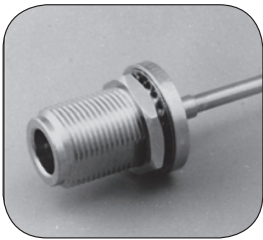

Fig. 1

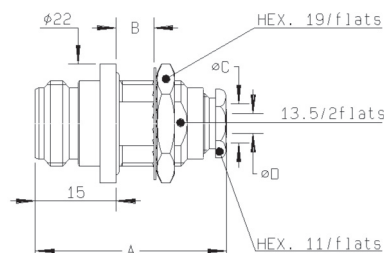

Fig. 2

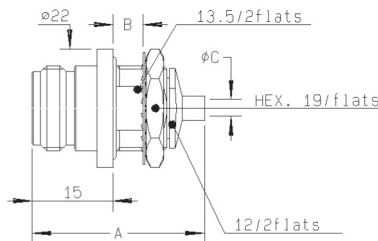

Fig. 3

Cable group	Cable group dia.	Part number	Fig.	Dimensions (mm)				Captive center contact	Panel drilling	Note
				A	B	C dia	D dia			
RG405	.085"	R161 335 200	1	32	6.5	2.25	no	P14	Solder type/Rear mount	
		R161 323 000	2	35.5	8	5.6			3.65	Clamp type/Font mount
RG402	.141"	R161 336 000	1	32	6.5	3.65			Solder type/Rear mount	
		R161 336 200	3						Solder type/Font mount	
RG401	.250"	R161 337 200	1			6.6	Solder type/Rear mount			

To download data sheets and assembly instructions, visit www.radiall.com & enter the part number in the Search box.
Bold part numbers represent products typically in stock & available for immediate shipment.
 See page 8 and 9 for packaging information.

RECEPTACLES

LOW PROFILE SQUARE FLANGE, STRAIGHT FEMALE RECEPTACLES

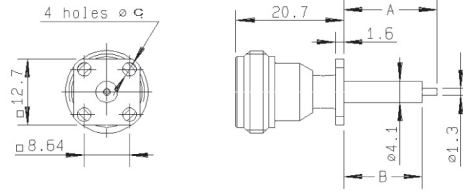

Part number	Dimensions (mm)			Captive center contact	Panel drilling	Note
	A	B	C dia			
R161 410 520	17.9	15	2.9	yes	P11	Extended dielectric

FLANGE, STRAIGHT FEMALE RECEPTACLES

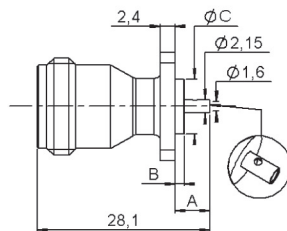

Fig. 1

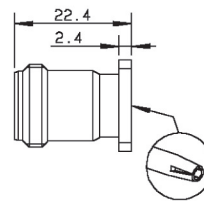

Fig. 2

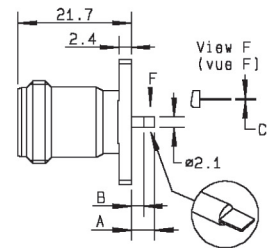

Fig. 3

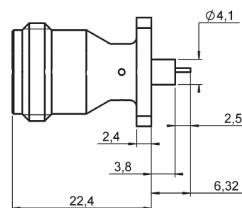

Fig. 4

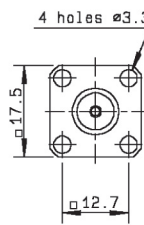

Fig. A

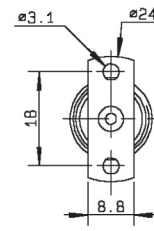

Fig. B

Part number	Fig.	Dimensions (mm)			Captive center contact	Panel drilling	Note
		A	B	C			
R161 410 000	1 + A	5.7	1.5	8.9	yes	P03	ECO version
R161A 410 000							
R161 410 130	4 + A	6.32	3.8	0.64		P16	Solder pot contact
R161 418 000	2 + A				yes	P03	Universal/see contacts page 12-22
R161 461 000	3 + B	6.2	3.9	0.6	yes	P12	2 hole flange/flat tab contact

STRAIGHT MALE AND FEMALE RECEPTACLES

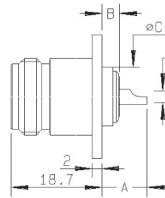

Fig. 1

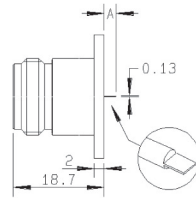

Fig. 2

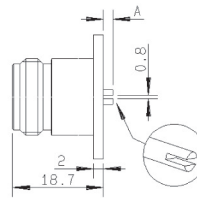

Fig. 3

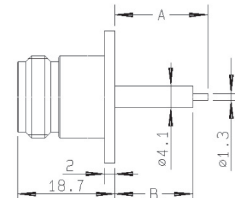

Fig. 4

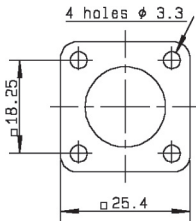

Fig. A

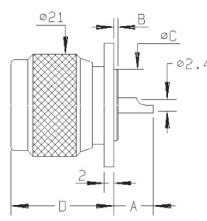

Fig. 5

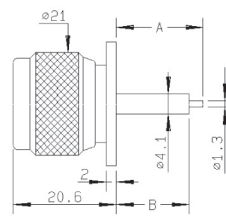

Fig. 6

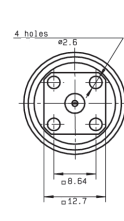
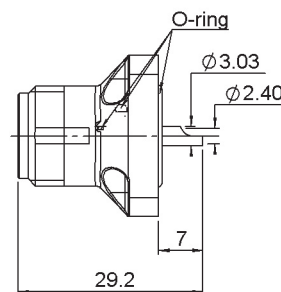
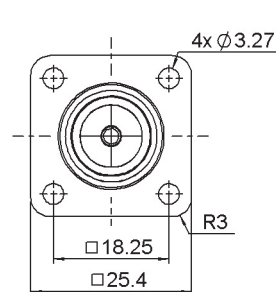

Fig. 7

Part number	Fig.	Dimensions (mm)				Captive center contact	Panel drilling	Note
		A	B	C dia	D			
R161 404 000	1 + A	9.3	0.8	14.6	yes	P07	Solder pot	
R161A 404 000							Solder pot/ECO version	
R161 404 137							For intermodulation application/ Center contact brass	
R161 416 130	4 + A	17.9	15	P09			Extended dielectric	
R161 419 020	2 + A	2.5		P10			Flat tab contact	
R161 419 300	3 + A	2		P01			Slotted contact	
R161 441 000	5 + A	8.7	0.8	14.6			P02	Male/solder pot
R161 441 400	6 + A	17.9	15				P06	Male/extended dielectric
R161 438 200	7						P11	

COMPOSITE FEMALE RECEPTACLES



Part number	Captive center contact	Description	Color	Packaging
R161 404 C01	yes	-	Black	50 pieces
R161 404 C02		Combination seal		
R161 404 C03		Panel seal		

Standard color is black however, other colors are proposed upon request. Other specific demands can be proceeded according to customer needs.

To download data sheets and assembly instructions, visit www.radiall.com & enter the part number in the Search box. **Bold** part numbers represent products typically in stock & available for immediate shipment. See page 8 and 9 for packaging information.

RECEPTACLES

RIGHT ANGLE FEMALE RECEPTACLES

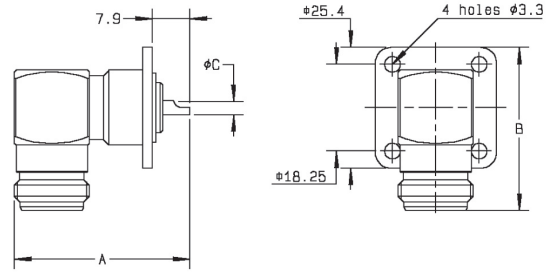

Part number	Dimensions (mm)			Captive center contact	Panel drilling	Note
	A	B	C dia			
R161 653 000	36.9	34.4	2.5	yes	P02	Solder pot

BULKHEAD STRAIGHT RECEPTACLES (fully sealed or panel hermetic)

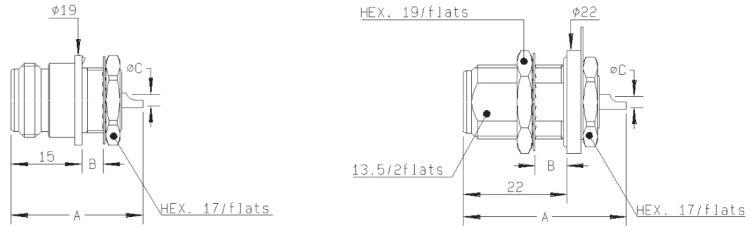

Fig. 1

Fig. 2

Fig. 3

Part number	Fig.	Dimensions (mm)			Captive center contact	Panel drilling	Note
		A	B	C			
R161 570 000	1	28	4.5	2.4	yes	P13	Front mount
R161 606 000	2	34.6	6.5	2.4		P14	Rear mount/fully sealed
R161A 606 010						P14	Rear mount/fully sealed/ECO version
R161 625 000	3	34	6.5	2.5		P14	Front mount/Panel hermetic

N SMT SWITCH AND RECEPTACLE

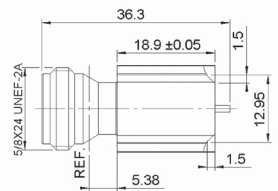

Fig. 1

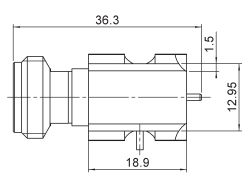
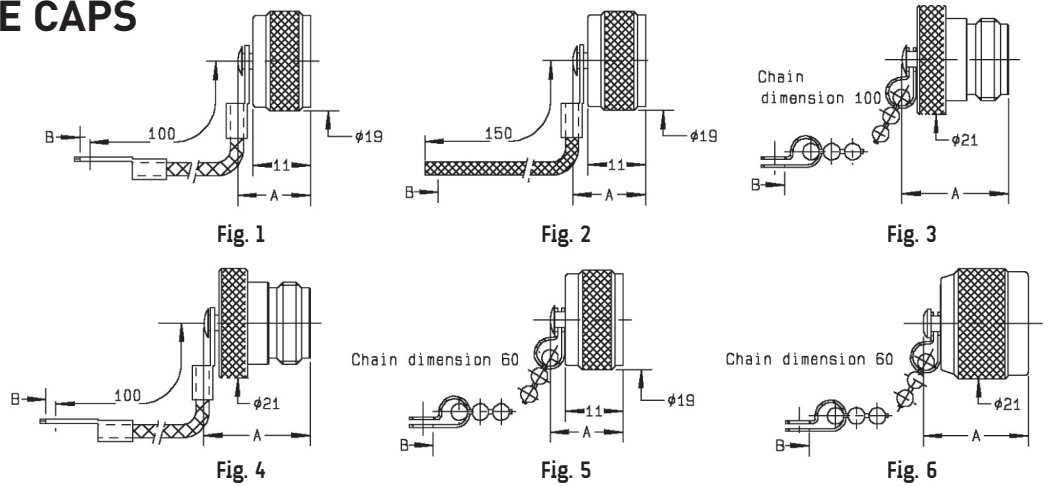

Fig. 2

Part number	Fig.	Note
R161 427 223	1	Edge card female receptacle
R161 428 223	2	Edge card SMT left type switch
R161 428 233		Edge card SMT right type switch

CAPS AND ACCESSORIES

PROTECTIVE CAPS



Part number	Fig.	Dimensions (mm)		Note
		A	B	
R161 804 000	1	13.9	3.8	Male with cord
R161 805 410	2	13.9	2	Male with cord
R161 841 000	3	20.4	3.9	Female with chain
R161 844 000	4	20.4	3.8	Female with cord
R161 853 000	5	13.9		Male with chain
R161 862 000	6	20.1	3.9	Male short circuit with chain

FIELD-REPLACEABLE CONTACTS (for universal receptacle)

These accessories have been specifically designed for the adjustment at the rear of hermetically sealed universal receptacles. The choice of their dimensions depends on the PCB or on the thickness of the MIC box. Moreover these contacts and insulators are also compatible with SMA UNIVERSAL RECEPTACLES.

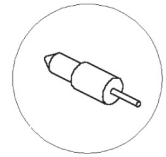
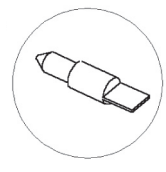
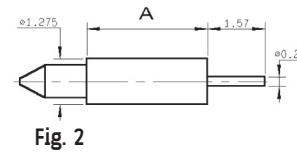
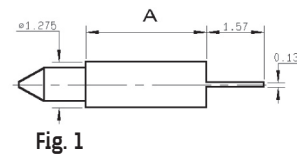
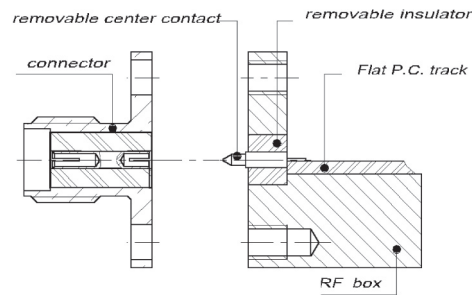
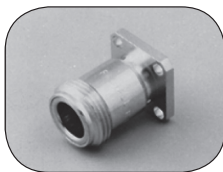

Part number	Fig.	A	Note	Associated insulator P/N
R280 461 000	1	3.37	Flat tab	R280 468 000
R280 463 000	2		Cylindrical tab	

FIELD-REPLACEABLE INSULATORS

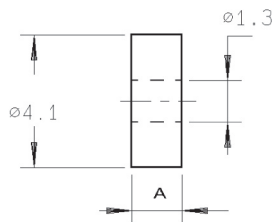

Part number	A	Packaging
R280 468 000	3.17	10

STRAIGHT PLUGS FOR SEMI-RIGID CABLES

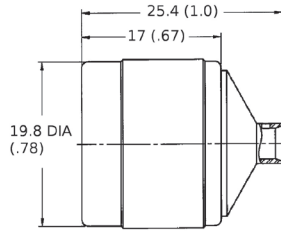

Cable group	Cable group dia.	Part number	Captive center contact	Material	Note
RG402	.141"	4000-1563-009	yes	Stainless steel	Direct solder
RG405	.085"	4000-1563-010			

Note: N18 GHz plugs for SHF high frequency flexible cable are available as cable assemblies only. Consult us for standard N18 GHz cable assembly part numbers.

BULKHEAD STRAIGHT JACKS, FOR SEMI-RIGID CABLES (panel sealed)

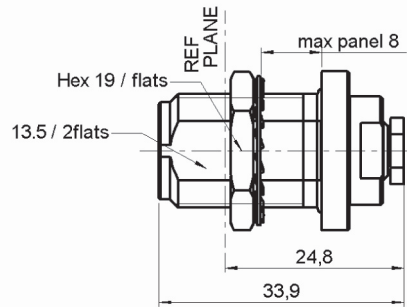
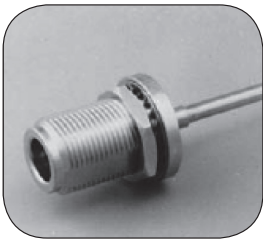

Cable group	Cable group dia.	Part number	Captive center contact	Panel drilling	Material	Note
RG405	.085"	4501-9543-009	yes	P14	Stainless steel	Solder clamp/ rear mount
RG402	.141"	4501-9543-010				
		R163 337 001				

IN SERIES ADAPTERS

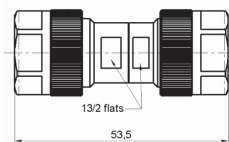

Fig. 1

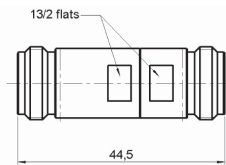

Fig. 2

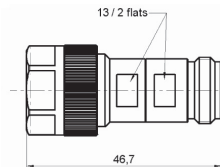

Fig. 3

Part number	Fig.	Dimension (mm)	Note
R163 703 001	1	53.5 (2.106)	Male-Male
R163 705 001	2	44.5 (1.752)	Female-Female
R163 708 001	3	46.7 (1.838)	Male-Female

Note: 7mm air line adapters also available upon request.

To download data sheets and assembly instructions, visit www.radiall.com & enter the part number in the Search box. **Bold part numbers** represent products typically in stock & available for immediate shipment. See page 8 and 9 for packaging information.

PLUGS AND JACKS

STRAIGHT PLUGS, FOR FLEXIBLE CABLES

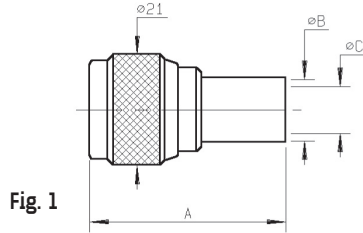

Fig. 1

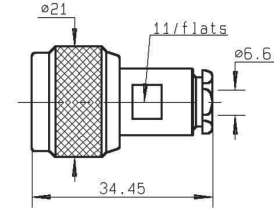

Fig. 2

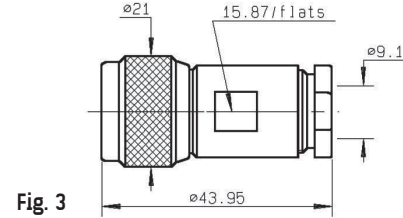

Fig. 3

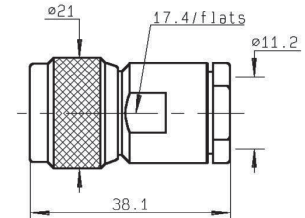

Fig. 4

Cable group	Cable group dia.	Part number	Fig.	Dimensions (mm)			Captive center contact	Note
				A	B dia	C dia		
RG59/RG62	6/75/S	R162 084 000	1	33.9	6.6	4	yes	Crimp type
	6/75+93	R162 012 000	2					
RG6	8/75/D	R162 013 000	3				no	Clamp type
RG11/RG12/RG144/RG216	10+11/75	R162 017 000	4					

STRAIGHT JACKS, CLAMP TYPE, FOR FLEXIBLE CABLES

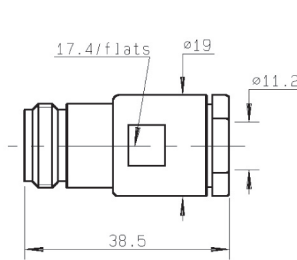
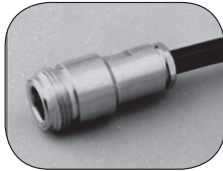

Fig. 1

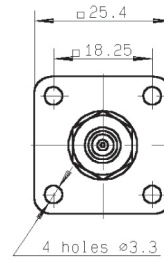
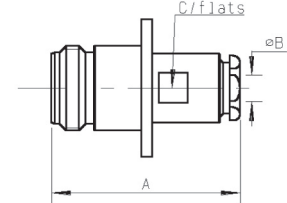
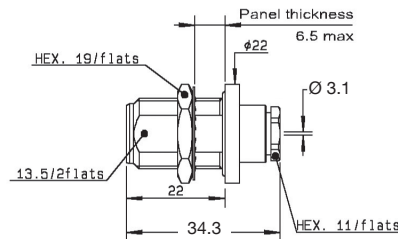

Fig. 2



Cable group	Cable group dia.	Part number	Fig.	Dimensions (mm)			Captive center contact	Panel drilling	Note
				A	B	C			
RG11/RG12/RG144/RG216	10+11/75	R162 217 000	1				no		Square flange
RG59/RG62	6/75+93/S	R162 262 000	2	34.9	6.6	11		P01	

STRAIGHT BULKHEAD JACKS, CLAMP TYPE, FOR FLEXIBLE CABLE (panel seal)



Cable group	Cable group dia.	Part number	Captive center contact	Panel drilling
RG179	2.6/75/S	R162 322 000	no	P14

To download data sheets and assembly instructions, visit www.radiall.com & enter the part number in the Search box. **Bold part numbers** represent products typically in stock & available for immediate shipment. See page 8 and 9 for packaging information.

FEMALE RECEPTACLES

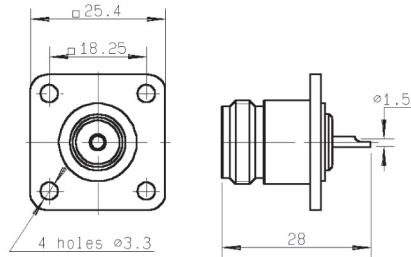

Fig. 1

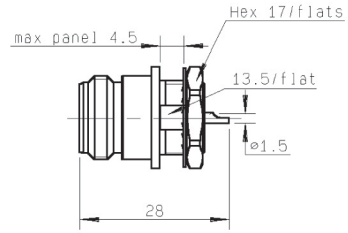

Fig. 2

Part number	Fig.	Captive center contact	Panel drilling
R162 403 000	1	yes	P07
R162 570 000	2		P15

IN SERIES ADAPTERS

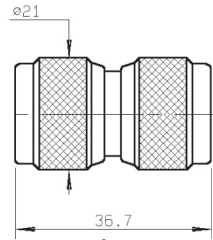
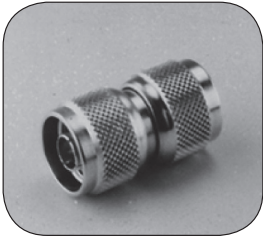

Fig. 1

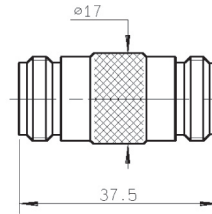
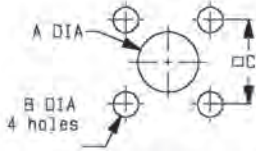

Fig. 2

Part number	Fig.	Captive center contact
R162 703 000	1	yes
R162 705 000	2	

To download data sheets and assembly instructions, visit www.radiall.com & enter the part number in the Search box. **Bold part numbers** represent products typically in stock & available for immediate shipment. See page 8 and 9 for packaging information.

P01



	MM		INCH	
	maxi	mini	maxi	mini
A	16.3	16.1	0.642	0.634
B	3.30	3.20	0.13	0.126
C	18.35	18.15	0.722	0.715

P02

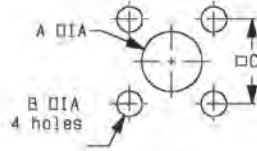

	MM		INCH	
	maxi	mini	maxi	mini
A	15.1	14.9	0.594	0.587
B	3.30	3.20	0.13	0.126
C	18.35	18.15	0.722	0.715

P03

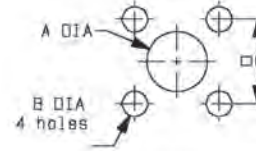

	MM		INCH	
	maxi	mini	maxi	mini
A	9.40	9.20	0.37	0.362
B	3.30	3.20	0.13	0.126
C	12.8	12.6	0.504	0.496

P04

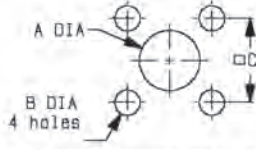

	MM		INCH	
	maxi	mini	maxi	mini
Front	21.7	21.5	0.854	0.846
Rear	19.7	19.5	0.776	0.768
B	3.30	3.20	0.13	0.126
C	18.35	18.15	0.722	0.715

P05



	MM		INCH	
	maxi	mini	maxi	mini
A	7.1	7	0.279	0.275
B	3.4	3.3	0.134	0.13
C	18.35	18.15	0.722	0.715

P06



	MM		INCH	
	maxi	mini	maxi	mini
A	4.2	4.1	0.165	0.161
B	3.3	3.2	0.13	0.126
C	18.35	18.15	0.722	0.715

P07

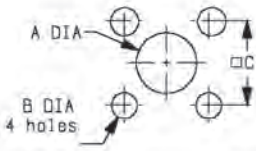

	MM		INCH	
	maxi	mini	maxi	mini
Front	16.3	16.1	0.642	0.634
Rear	15.1	14.9	0.594	0.587
B	3.30	3.20	0.13	0.126
C	18.35	18.15	0.722	0.715

P08



	MM		INCH	
	maxi	mini	maxi	mini
A	12.5	12.3	0.492	0.484
B	3.3	3.2	0.13	0.126
C	18.35	18.15	0.722	0.715

P09



	MM		INCH	
	maxi	mini	maxi	mini
Front	16.3	16.1	0.642	0.634
Rear	4.2	4.1	0.165	0.161
B	3.3	3.2	0.13	0.126
C	18.35	18.15	0.722	0.715

P10



	MM		INCH	
	maxi	mini	maxi	mini
Front	16.3	16.1	0.642	0.634
Rear	12.5	12.3	0.492	0.484
B	3.3	3.2	0.13	0.126
C	18.35	18.15	0.722	0.715

P11



	MM		INCH	
	maxi	mini	maxi	mini
A	4.2	4.1	0.165	0.161
B	2.7	2.6	0.106	0.102
C	8.69	8.59	0.342	0.338

P12

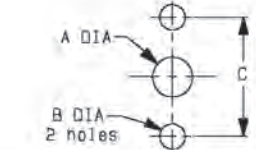

	MM		INCH	
	maxi	mini	maxi	mini
A	5	4.80	0.197	0.189
B	3.30	3.20	0.13	0.126
C	18.1	17.9	0.713	0.705

P13

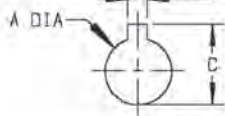

	MM		INCH	
	maxi	mini	maxi	mini
A	14.3	14.1	0.563	0.555
B	2.30	2.20	0.091	0.087
C	17	16.8	0.669	0.661

P14



	MM		INCH	
	maxi	mini	maxi	mini
A	16.1	16	0.634	0.63
B	13.7	13.6	0.539	0.535

P15

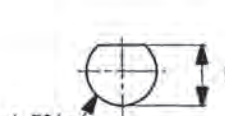

	MM		INCH	
	maxi	mini	maxi	mini
A	14.3	14.1	0.563	0.56
B	13.8	13.6	0.543	0.535

P16

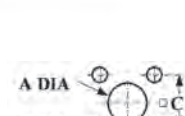

	mm	
	Maxi	mini
A	4.25	4.15
B	3.4	3.2
C	12.8	12.6