

Fakra R3C – Right-Angle housing  
Cable type **RG174** (2.6/50) & **RTK** (3.2/50)

R197.125.\_80

TECHNICAL DATA SHEET

Rev	Date	Edited	Approved	Validated	Modification
1	21/06/2018	C.Chavanne	Y.Gay	R.Chantre	Creation

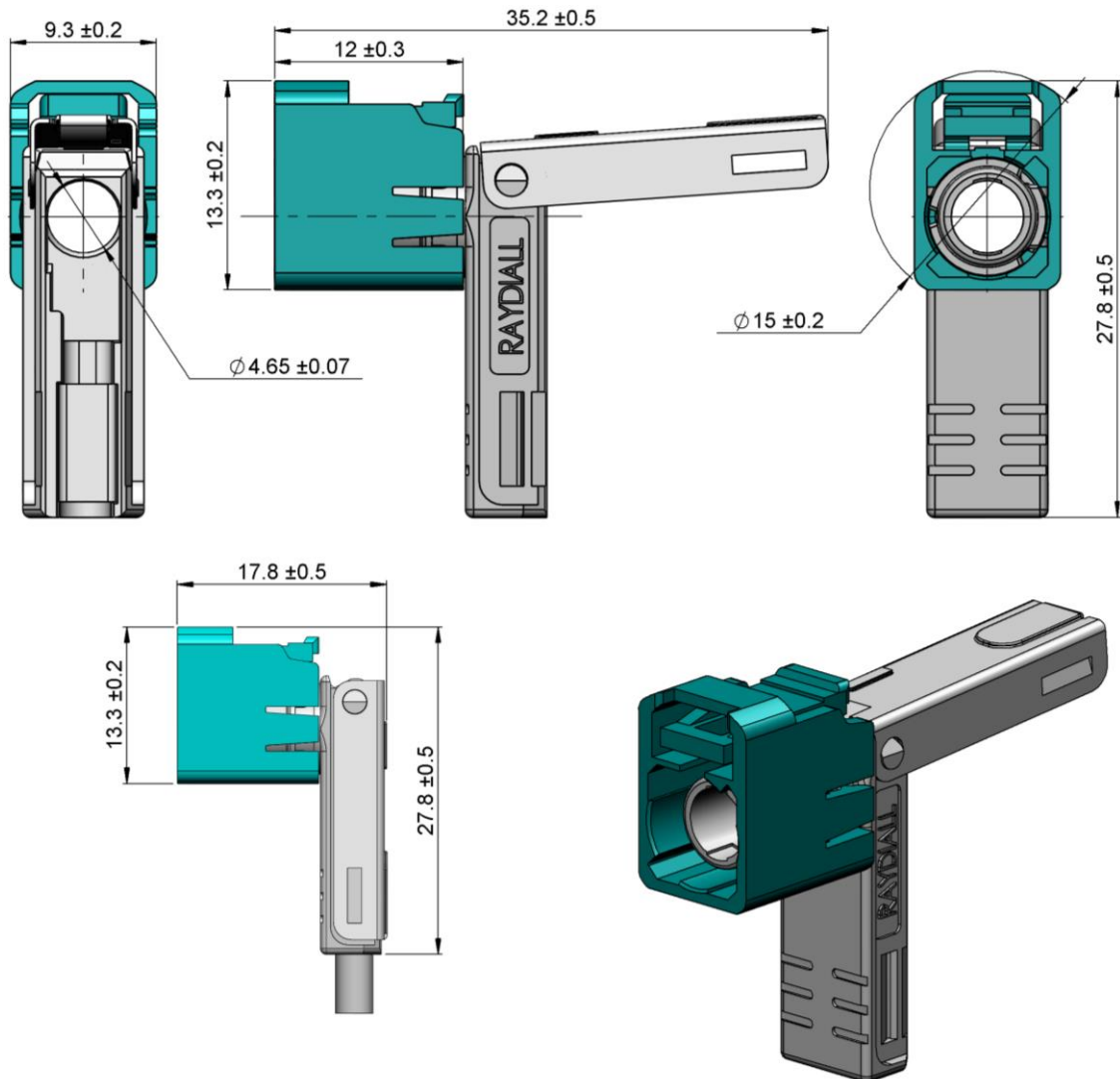

All dimensions are in mm

COMPONENTS	MATERIALS	UL CLASSIFICATION	COLOR
Housing	Polyamide	UL 94 V-2	See page 2
Cap	Inox		
Sleeve	Die Cast	Chromatation	Tint variation may happen depending on moulding shots

Fakra R3C – Right-Angle housing  
Cable type **RG174** (2.6/50) & **RTK** (3.2/50)

R197.125.\_80

TECHNICAL DATA SHEET

**Interface**

According to

**ISO 20860-1**

**Application**

This housing is part of an assembly to create a complete R-A R3C connector. It has to be assembled with a terminal.  
Refer to **Assembly Instructions AI\_R-AR3C** to get the corresponding P/N.

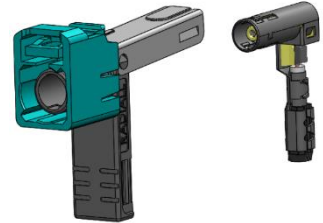

**Codings**

To obtain the complete part number, please fill in the blank “\_” with the coding letter.

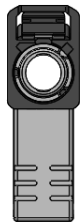

**A**  
Black  
RAL 9005

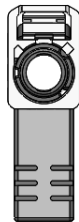

**B**  
Crème White  
RAL 9001

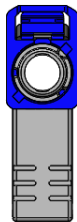

**C**  
Blue  
RAL 5005

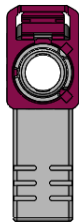

**D**  
Bordeaux  
RAL 4004

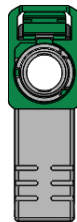

**E**  
Green  
RAL 6002

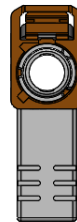

**F**  
Brown  
RAL 8011

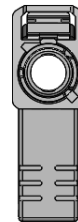

**G**  
Grey  
RAL 7031

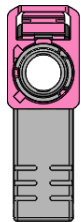

**H**  
Violet  
RAL 4003

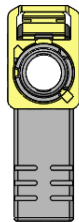

**I**  
Beige  
RAL 1001

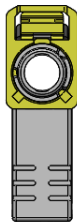

**K**  
Curry  
RAL 1027

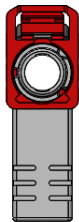

**L**  
Carmin  
RAL 3002

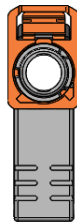

**M**  
Pastel Orange  
RAL 2003

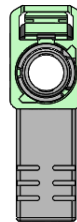

**N**  
Pastel Green  
RAL 6019

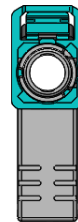

**Z**  
Water blue  
RAL 5021

**Net Weight:** 4.63 g

**Storage condition & Shelf Life**

Boxes should be stored indoors, in its original packaging (box + plastic bag), in a controlled climate environment not exceeding -20°C/+40°C and maximum 70% relative humidity. The boxes should be protected from direct sunlight and should be used on a "first-in, first-out" basis.

It is recommended to use this reference within 1 year from the date of manufacture when stored according the recommended storage condition.

**Product Handling**

Care must be taken when handling the boxes of housings. They must not fall. Indeed it might unwillingly lock the cap, which makes the housing un-usable.