

Fakra R3C – Straight Duplex Female housing
Cable type **RG174** (2.6/50) & **RTK** (3.2/50)

R197.215._80

TECHNICAL DATA SHEET

Rev	Date	Edited	Approved	Validated	Modification
1	25/06/2018	C.Chavanne	Y.Gay	R.Chantre	Creation

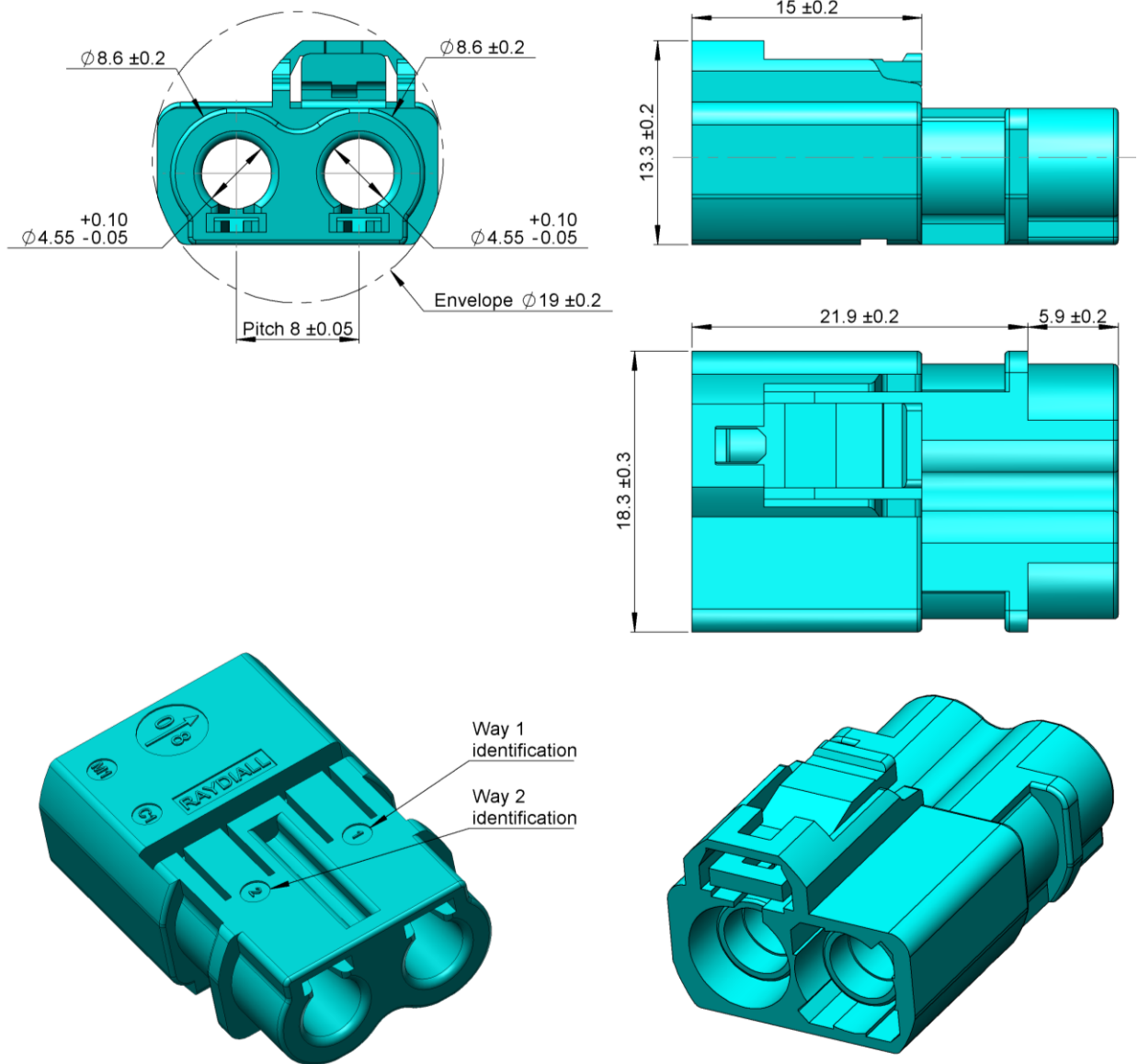

All dimensions are in mm

COMPONENTS	MATERIALS	UL CLASSIFICATION	COLOR
Housing	Polyamide	UL 94 V-2	See page 2

Fakra R3C – Straight Duplex Female housing

Cable type **RG174** (2.6/50) & **RTK** (3.2/50)



R197.215._80

TECHNICAL DATA SHEET

Interface

According to

ISO 20860-1

Application

This housing is part of an assembly to create a complete R3C connector. It has to be assembled with two terminals.

Refer to **Assembly Instructions AI_R3C** to get the corresponding P/N.

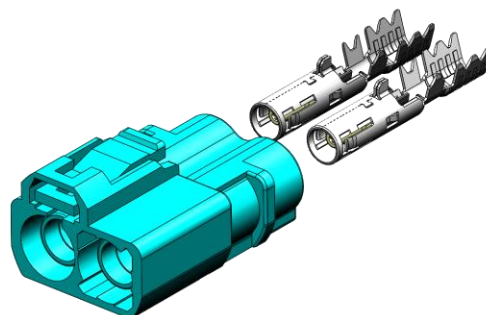

Codings

To obtain the complete part number, please fill in the blank “_” with the coding letter.



A
Black
RAL 9005

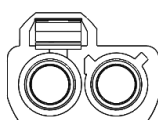

B
Crème White
RAL 9001

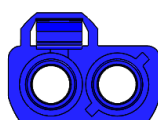

C
Blue
RAL 5005



D
Bordeaux
RAL 4004

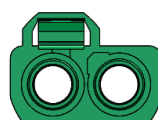

E
Green
RAL 6002

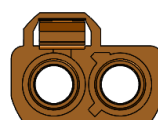

F
Brown
RAL 8011

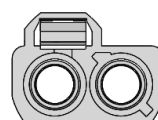

G
Grey
RAL 7031

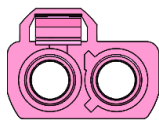

H
Violet
RAL 4003

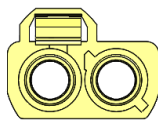

I
Beige
RAL 1001

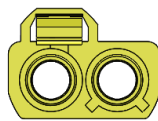

K
Curry
RAL 1027

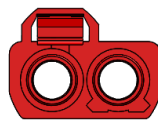

L
Carmin
RAL 3002

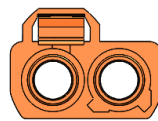

M
Pastel Orange
RAL 2003

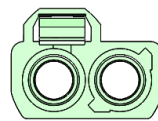

N
Pastel Green
RAL 6019

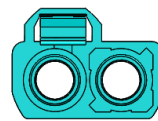

Z
Water blue
RAL 5021

Net Weight: 3.06 g

Storage condition & Shelf Life

Boxes should be stored indoors, in its original packaging (box + plastic bag), in a controlled climate environment not exceeding -20°C/+40°C and maximum 70% relative humidity. The boxes should be protected from direct sunlight and should be used on a "first-in, first-out" basis.

It is recommended to use this reference within 1 year from the date of manufacture when stored according to the recommended storage condition.

Product Handling

Care must be taken when handling the boxes of housings. They must not fall.