

STRAIGHT PCB CABLE TERMINALS

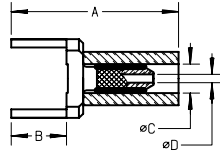
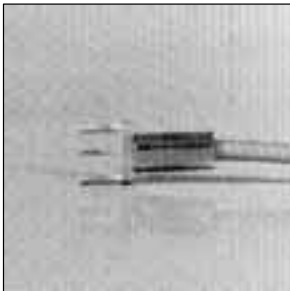

Fig. 1

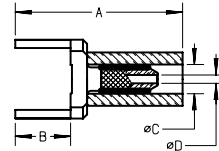
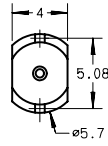

Fig. 2

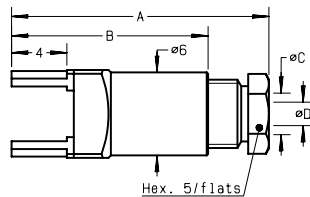
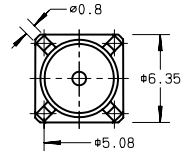

Fig. 3

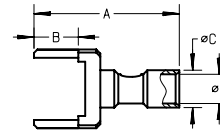
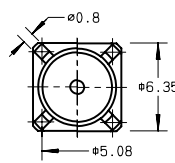

Fig. 4

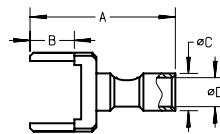
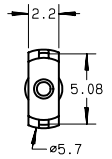

Fig. 5

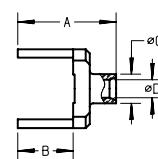
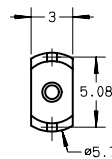
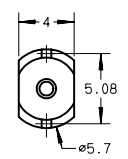

Fig. 6



cable group	part number	fig.	imp.(Ω)	dimensions (mm)				finish	note
				A	B	C	D		
2 /50/ S	R280 280 000	1	50	12.1	4	2.55	1.1	Gold	2 pins / crimp
2 /50/ S	R280 280 020	1	50	12.1	4	2.55	1.1	BBR	2 pins / crimp
2 /50/ S	R280 282 000	2	50	16.2	4	2.55	1	Gold	4 pins / crimp
2 /50/ S	R280 281 000	3	50	18.6	14.2	2.2	1	Nickel	4 pins / clamp
2 /50/ S	R280 221 000	4	50	10.5	3.2	2.7	1.45	Gold	2 pins / solder
2 /50/ S	R280 221 020●	4	50	10.5	3.2	2.7	1.45	BBR	2 pins / solder
2.6 /50 + 75/ S	R280 280 100	1	50	12.1	4	2.95	1.65	Gold	2 pins / crimp
2.6 /50 + 75/ S	R280 280 120	1	50	12.1	4	2.95	1.65	BBR	2 pins / crimp
2.6 /50 + 75/ S	R280 284 000	2	50	17.2	4	3.25	1.7	Nickel	4 pins / crimp
2.6 /50 + 75/ S	R280 283 000	3	50	18.6	14.2	3	1.7	Nickel	4 pins / clamp
2.6 /50 + 75/ S	R280 222 000	5	50	8.4	3.2	3.15	2.3	Gold	2 pins / solder
2.6 /50 + 75/ S	R280 222 020●	5	50	8.4	3.2	3.15	2.3	BBR	2 pins / solder
2.6 /50 + 75/ D	R280 280 200●	1	50	12.1	4	3.25	1.65	Gold	2 pins / crimp
2.6 /50 + 75/ D	R280 280 220●	1	50	12.1	4	3.25	1.65	BBR	2 pins / crimp
.047	R280 287 100●	6	50	7.1	4	2	1.3	Gold	2 pins / solder
.047	R280 287 120●	6	50	7.1	4	2	1.3	Tin lead	2 pins / solder
.085	R280 287 200	6	50	7.1	4	3	2.25	Gold	2 pins / solder
.085	R280 287 220●	6	50	7.1	4	3	2.25	Tin lead	2 pins / solder

● Upon request.

RIGHT ANGLE PCB CABLE TERMINALS

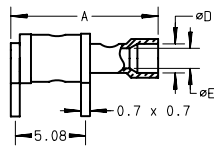

Fig. 1

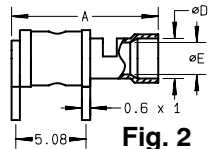

Fig. 2

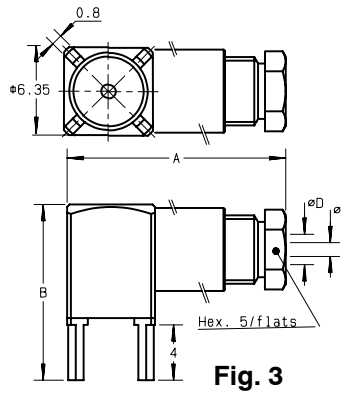

Fig. 3

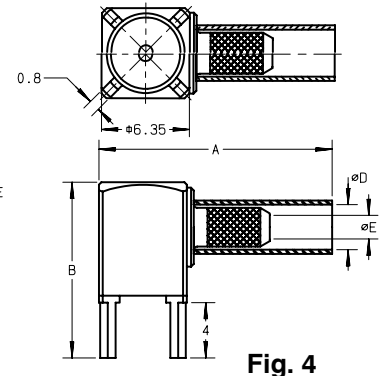

Fig. 4

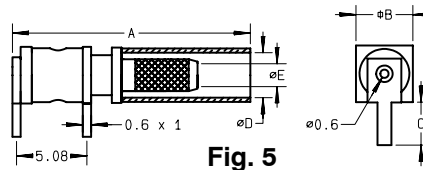
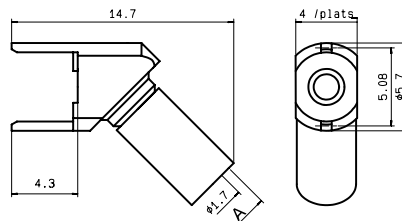

Fig. 5

cable group	part number	fig.	imp.(Ω)	dimensions (mm)					finish	note
				A	B	C	D	E		
2/50/S	R280 219 000	1	50	10.90	3.60	3.45	2.10	1.45	Gold	2 pins / solder
2 / 50 / S	R280 219 008●	1	50	10.90	3.60	3.45	2.10	1.45	Tin lead	2 pins / solder
2 / 50 / S	R280 219 020●	1	50	10.90	3.60	3.45	2.10	1.45	Tin lead	2 pins / solder
2 / 50 / S	R280 291 000	3	50	19.80	12.70		2.20	1.00	Nickel	4 pins / clamp
2 / 50 / S	R280 292 000	4	50	16.85	12.70		2.55	1.00	Gold	4 pins / crimp
2.6/50+75/S	R280 220 007●	2	50	10.70	4.10	3.10	2.90	2.30	BBR	2 pins / solder
2.6/50+75/S	R280 220 008	2	50	10.70	4.10	3.10	2.90	2.30	Tin lead	2 pins / solder
2.6 / 50 / D	R280 220 200	1	50	10.90	4.10	3.10	2.90	2.40	Gold	2 pins / solder
2.6 / 50 / D	R280 220 220	1	50	10.90	4.10	3.10	2.90	2.40	Tin lead	2 pins / solder
2.6/50+75/S	R280 293 000	3	50	19.80	12.70		3.00	1.70	Tin lead	4 pins / clamp
2.6/50+75/S	R280 294 000	4	50	16.85	12.70		3.25	1.70	Tin lead	4 pins / crimp
2.6/50+75/S	R280 294 308●	5	50	17.20	4.10	3.10	3.25	1.70	Nickel+tin lead	2 pins / crimp

45° ANGLE PCB TERMINALS



cable group	part number	imp.(Ω)	dimensions (mm)		finish
			A		
2.6 / 50 / S	R280 296 000	50	2.95		Tin lead
2.6 / 50 / D	R280 296 120	50	3.25		Tin lead

● Upon request.