



# TestPro

## Cable assemblies

 Take advantage of navigation shortcuts

[Click here for Table of Contents](#)  
[Click here for Index by P/N](#)

# COMPANY PROFILE

*Radiall was founded in 1952 as a family owned company making coaxial plugs for the television industry. Today, Radiall is an international and global manufacturer of interconnect components including RF coaxial connectors and cable assemblies, antennas, fiber optic and microwave components, and multipin connectors. Radiall serves the Aerospace, Automotive, Defense, Industrial, Medical, Space, and Telecommunication industries.*

## QSE (Quality Safety Environment) POLICY

Radiall maintains a quality management system that is highly recognized by its customers because it conforms to most international standards, including those for environmental protection.



Since 1994, all Radiall sites are ISO9001 certified. As a result of Radiall's continuous improvement efforts, some dedicated activities are certified to either AS9100, or TS 16949 or ISO14001. Certain product lines are MIL ESA/SCC Qualified products.

Radiall also complies with other industry directives such as RoHS for hazardous substance restrictions and EuP for environmentally friendly designs for energy-consuming products.



## A WORLDWIDE ENGINEERING & MANUFACTURING CAPABILITY



Technical information and sales contacts are available at : [www.radiall.com](http://www.radiall.com)

With expertise centers and manufacturing locations in 3 continents and 12 industrial sites, Radiall offers its customers the proximity needed to provide the best quality, service and delivery performance.

Our facilities feature state of the art equipment for the many technologies involved in the design, manufacturing and assembly of interconnect solutions. Manufacturing plants based in low cost countries give Radiall the opportunity to offer quality at competitive prices.

 **Click on any line to go to the page.**

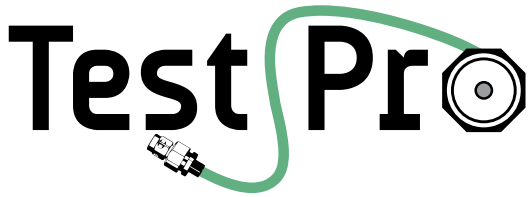

<b>General information</b>	<b>Page</b>
Introduction .....	4
Design .....	5
 <b>Characteristics</b>	
TestPro 4.2 Bench test cable.....	6
TestPro 3 Bench test cable.....	7
TestPro 3 Low Profile test cable.....	8
TestPro 5 Ultra Low Loss .....	9
TestPro 8 Ultra Low Loss .....	10
 <b>TestPro Standard assembly lengths</b>	
TestPro 4.2 Phase Stable .....	11
TestPro 5 & 8 Ultra Low Loss .....	12
 <b>TestPro custom assemblies</b>	
How to order .....	13
Aarmor option .....	14
Connectors for TestPro 4.2 .....	15
Connectors for TestPro 3 .....	16
Connectors for TestPro 3 Low Profile.....	17
Connectors for TestPro 5.....	18
Connectors for TestPro 8 .....	20
Accessories .....	22



The TestPro product range is dedicated to **Test and Measurement applications** requiring excellent electrical performance, high mechanical endurance and excellent resistance to wear and corrosion. We offer 2 product categories to meet your needs:

- **TestPro 4.2 and TestPro 3 « Phase Stable »** are suitable for test benches in production or labs due to its long life and stability in dynamic use.
- **TestPro 5 & 8 « Ultra low loss »** allow the use of long length cables with remote test stations and anechoic chambers. Their high stability with temperature makes them easy to use in temperature chambers. They are also suitable for high power applications.

Our TestPro product range is designed to operate in the DC - 26.5 GHz frequency range depending on connector and cable choice.

Our optional protective jacket "ProJack" protect lab cable assemblies for greater life time. It is also dedicated for all defense systems tests running outdoors.

All components are designed and manufactured by RADIAL in facilities operated under ISO9001-V2000/ASN9100 quality standards.

## ONLINE WEBTOOL FOR QUICK SERVICE

To access our online tools and build your desired cable assembly, go to [www.radiall.com/cableassembly](http://www.radiall.com/cableassembly)

Select our «Test & Measurement» tool for TestPro cable assemblies.

This tool enables you to select from a list of standard assembly lengths and part numbers or to build your own TestPro assembly by selecting cable and connectors that meet your needs. The TestPro tool also provides the performance of the desired cable assembly.

### OPTION 1:

- Select standard assembly lengths
- View performance

### OPTION 2:

- Build your assembly
- Calculate performance



[www.radiall.com](http://www.radiall.com)



## CABLE DESIGN and MANUFACTURING

The TestPro cable range benefits from Radiall's 30 years of experience in manufacturing high tech microwave cables for the military and aerospace markets. TestPro cables were designed to meet test and measurement specific requirements.

Radiall manufactures its own cable using proprietary braiding machines. Low density PTFE tape wrapping is the heart of our process. It elevates our Ultra Low Loss TestPro cable to a position of best performance in the market.

Our expertise in high precision multilayer braiding and wrapping makes the TestPro cable range stable over thousands of bending life cycles.

## 5000 MATING CYCLES GUARANTEED

TestPro cable assemblies for test applications were developed using new highly ruggedized stainless steel connectors. Our TestPro connectors are extremely robust. The combination of higher grade stainless steel and a unique attachment method offers a very reliable product over multiple matings.

Performance after 5,000 matings

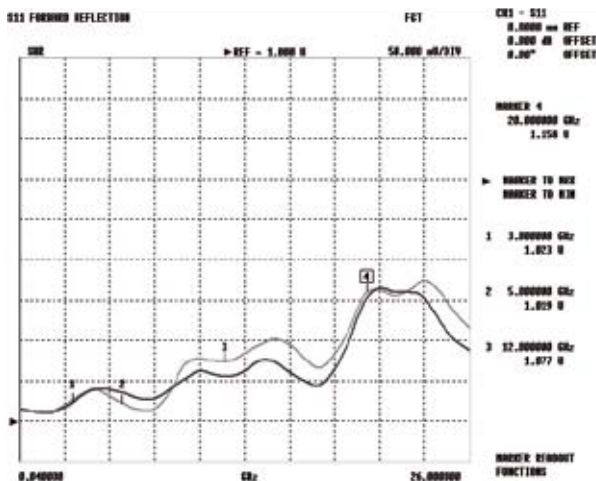

- Low contact resistance variation
- < 0.3 mΩ
- VSWR 1.11 at 18 GHz

## CONNECTOR ATTACHMENT

The connector attachment is the main weakness when using standard cable assemblies in test and measurement applications.

Radiall TestPro connectors are designed with a unique attachment process which elevates the assembly ruggedness, provides high electrical stability and a very long life.



# CHARACTERISTICS



## CONSTRUCTION / DIMENSIONS

	material	mm	inches
center conductor	solid SPCC <sup>(1)</sup>	-	-
dielectric	solid PTFE <sup>(2)</sup>	-	-
inner shield	flat SPC tape	-	-
interlayer	Aluminum-Polyimide tape	-	-
outer shield	round SPC braid	-	-
jacket	clear FEP <sup>(3)</sup>	max. 4.81	max. 0.190

- <sup>(1)</sup> SPCC = Silver Plated Copper Clade Steel
- <sup>(2)</sup> PTFE = Poly TetraFluoroEthylene
- <sup>(3)</sup> FEP = Fluorinated Ethylene Propylene

## ELECTRICAL CHARACTERISTICS

characteristic impedance	50 ohms ± 2 ohms	
operating frequency range	DC - 20 GHz	
cut-off frequency	34 GHz	
screening effectiveness	> 100 dB (at 18 GHz)	
velocity of propagation	71 %	
propagation time	4.75 ns / m	4.75 ns / ft
capacitance	95 pF / m (at 1 GHz)	29 pF / ft (at 1 GHz)
insulation resistance	> 3 x 10 <sup>5</sup> MOhm / m	
nominal phase	1645 ° / m / GHz	
phase stability with bending*	< 0.17° / 360° / GHz (at 18 GHz)	
attenuation stability with bending*	< 0.015 dB (at 18 GHz)	
attenuation stability with shaking	< 0.01 dB/m (at 18 GHz)	

\* = the cable is coiled up 10 times onto a mandrel of 100 mm (3.94") diameter.



Radiall P/N : F1100001

## MECHANICAL CHARACTERISTICS

maximum weight	60g / m	18.3g / ft
recommend. min. bend radius	25 mm	0.98 inch
crush resistance	> 2300N / 100 mm	

### APPLICATION NOTE

TestPro 4.2 is a high frequency microwave cable that delivers good attenuation characteristics. This low loss triple-shielded cable provides the best combination of low attenuation and VSWR/loss/phase stability when compared to similar size flexible cables. The TestPro 4.2 rugged structure is perfectly adapted for dynamic applications such as laboratory measurements when assembled with TestPro connectors.

## ENVIRONMENTAL CHARACTERISTICS

operating temperature range	-55 / +200° C	-67 / +392° C
fire resistance	yes	
halogen free jacket	no	

## FREQUENCY / ATTENUATION (typ.) / CW MAX POWER (sea level / 25° C)

GHz	dB / m	dB / ft	Watts
1.0	0.41	0.12	550
2.0	0.60	0.18	295
4.0	0.87	0.26	210
8.0	1.29	0.39	150
12.4	1.67	0.51	120
18.0	2.10	0.64	95
20.0	2.24	0.68	80
attenuation calculation (dB/m)	(0.384 x √F GHz) + (0.026 x F GHz)		

Note: typical attenuation for two connectors (dB) = 0.0447 x √F GHz + 0.04

**CONSTRUCTION / DIMENSIONS**

	material
center conductor	SPCCS <sup>(1)</sup>
dielectric	PTFE <sup>(2)</sup>
electrical shield	SPC <sup>(3)</sup>
interlayer	Aluminum-polyimide
inner braid	SPC <sup>(3)</sup>
inner jacket	PFA <sup>(4)</sup>
crush protection	stainless steel
strength braid	stainless steel
braid jacket	PTFE <sup>(2)</sup>
outer diameter	7,04 mm ( 0,277 inches)

- <sup>(1)</sup> SPCCS = Silver Plated Copper Clad Steel
- <sup>(2)</sup> PTFE = PolyTetraFluoroEthylene
- <sup>(3)</sup> SPC = Silver Plated Copper
- <sup>(4)</sup> PFA = PerFluoroAlkoxy

**ELECTRICAL CHARACTERISTICS**

characteristic impedance	50 ohms ± 1 ohms	
operating frequency range	DC - 40 GHz	
cut-off frequency	44 GHz	
screening effectiveness	>100 dB at 1GHz; > 90 dB at 18 GHz	
velocity of propagation	76%	
propagation time	4.4 ns / m	1.3 ns / ft
capacitance	88 pF / m (at 1 GHz)	26.7 pF / ft (at 1 GHz)
insulation resistance	> 3 x 10 <sup>5</sup> MOhm / m	
Corona extinction voltage	-	
nominal phase	1590 ° / m / GHz	
phase stability with temperature	< 4 ° / m / GHz ; <2820ppm (-55 / +125°C)	
phase stability with bending (**)	5° (at 40 GHz) Typ.	
attenuation stability with bending(**)	< 0.1 dB (at 40 GHz)	
attenuation stability with shaking	< 0.03 dB/m (at 40 GHz)	
atten. variation with temperature	Att. (at X° C) = att. (at 20° C) x (1 + (X - 20) x 0,002)	

(\*\*) 9.5° Max according to IEC966-1, bending method n°2

**MECHANICAL CHARACTERISTICS**

maximum weight	150 g / m	46.3 g / ft
recommend. min. bend radius	25 mm	0.984 inch
crush resistance	> 4,400 N / 100 mm (260 lb per linear inch)	
Flex life cycle	20,000 (IEC 966-1 section 9.3)	
tensile strength	200 N	

**ENVIRONMENTAL CHARACTERISTICS**

operating temperature range <sup>(*)</sup>	-55 / +200 ° C	-67 / +392 ° F
fire resistance	yes (MIL C 87104)	
abrasion resistance	yes (SAE AS5756, edge 0.5 mm, load 2 pounds)	
halogen free jacket	no	
ROHS / REACH	yes	

(\*) cable alone. Cable assembly operating temperature range is -55 / + 105 °C (-67 / +221°F)

**FREQUENCY / ATTENUATION (typ) / CW MAX POWER <sup>(\*)</sup>**

GHz	(dB/m)	(dB/ft)	Watts
1,0	0,39	0,12	400
2,0	0,56	0,17	280
4,0	0,81	0,25	200
6,0	1,01	0,31	160
8,0	1,19	0,36	140
12,4	1,53	0,46	120
18,0	1,91	0,58	90
26,5	2,41	0,73	80
40,0	3,11	0,94	60

attenuation calculation (dB/m) Typ: (0.365 x √ FGHz) + (0.02 x F GHz)

<sup>(\*)</sup> = CW max power calculated at sea level / 40°C and VSWR 1:1

Power ratings may be limited by the connector type. Please contact us for specific needs)

Note : typical attenuation for a couple of connectors (dB) = 0,0447 x √ F (GHz) + 0.04



**APPLICATION NOTE**

TestPro 3 is a 40GHz measurement cable. It combines electrical advantages and integrated protection system. These ruggedized assemblies offer excellent durability while remaining exceptionally flexible. Unique connector attachment system and strong cable structure provide high tensile stress resistance to the whole assembly.

**Key features & benefits**

- Phase and loss stable with flexure
- Crush, torque and tensile resistant
- Flexible
- Long service life
- Longer calibration intervals
- Easy to configure to DUT

Typical applications include : test labs, production floor testing, anechoic chambers, thermal vacuum chambers and nearfield scanners.

**CONSTRUCTION / DIMENSIONS**

	material
center conductor	SPCCS <sup>(1)</sup>
dielectric	PTFE <sup>(2)</sup>
electrical shield	SPC <sup>(3)</sup>
interlayer	Aluminum-polyimide
strength braid	SPC <sup>(3)</sup>
outer jacket	PFA <sup>(4)</sup>
outer diameter	3,95 mm (0,156 inches)

- <sup>(1)</sup> SPCCS = Silver Plated Copper Clad Steel
- <sup>(2)</sup> PTFE = PolyTetraFluoroEthylene
- <sup>(3)</sup> SPC = Silver Plated Copper
- <sup>(4)</sup> PFA = PerFluoroAlkoxy

**ELECTRICAL CHARACTERISTICS**

characteristic impedance	50 ohms ± 1 ohms	
operating frequency range	DC - 40 GHz	
cut-off frequency	44 GHz	
screening effectiveness	>100 dB at 1GHz; > 90 dB at 18 GHz	
velocity of propagation	76%	
propagation time	4.4 ns / m	1.3 ns / ft
capacitance	88 pF / m (at 1 GHz)	26.7 pF / ft (at 1 GHz)
insulation resistance	> 3 x 10 <sup>5</sup> MOhm / m	
Corona extinction voltage	-	
nominal phase	1590 ° / m / GHz	
phase stability with temperature	< 4 ° / m / GHz ; <2820ppm (-55 / +125°C)	
phase stability with bending (**)	5° (at 40 GHz) Typ.	
attenuation stability with bending(**)	< 0.1 dB (at 40 GHz)	
attenuation stability with shaking	< 0.03 dB/m (at 40 GHz)	
atten. variation with temperature	Att. (at X° C) = att. (at 20° C) x (1 + (X - 20) x 0,002)	

(\*\*) 9,5° Max according to IEC966-1, bending method n°2

**MECHANICAL CHARACTERISTICS**

maximum weight	50 g / m	15.3 g / ft
recommend. min. bend radius	25 mm	0.984 inch
crush resistance	> 400 N / 100 mm (23 lb per linear inch)	
Flex life cycle	20,000 (IEC 966-1 section 9.3)	
tensile strength	200 N	

**ENVIRONMENTAL CHARACTERISTICS**

operating temperature range <sup>(*)</sup>	-55 / +200 ° C	-67 / +392 ° F
fire resistance	yes (MIL C 87104)	
halogen free jacket	no	
ROHS / REACH	yes	

(\*) cable alone. Cable assembly operating temperature range is -55 / + 105 °C (-67 / +221°F)

**FREQUENCY / ATTENUATION (typ) / CW MAX POWER <sup>(\*)</sup>**

GHz	(dB/m)	(dB/ft)	Watts
1,0	0,39	0,12	400
2,0	0,56	0,17	280
4,0	0,81	0,25	200
6,0	1,01	0,31	160
8,0	1,19	0,36	140
12,4	1,53	0,46	120
18,0	1,91	0,58	90
26,5	2,41	0,73	80
40,0	3,11	0,94	60
attenuation calculation (dB/m)	Typ: (0.365 x √ FGHz) + (0.02 x F GHz)		

(\*) = CW max power calculated at sea level / 40°C and VSWR 1:1

Power ratings may be limited by the connector type. Please contact us for specific needs

Note : typical attenuation for a couple of connectors (dB) = 0,0447 x √ F (GHz) + 0.04



**APPLICATION NOTE**

TestPro 3 is a 40GHz measurement cable. It combines electrical advantages and small form factor. These assemblies offer excellent durability while remaining exceptionally flexible. It is dedicated to connect to high density connectors panel. Unique connector attachment system and strong cable structure provide high tensile stress resistance to the whole assembly.

**Key features & benefits**

- Phase and loss stable with flexure
- Low Profile (assemblies max dia < 9 mm)
- Flexible
- Longer calibration intervals
- Easy to configure to DUT

Typical applications include : test labs, production floor testing, anechoic chambers, thermal vacuum chambers and nearfield scanners.



**CONSTRUCTION / DIMENSIONS**

	material	mm	inches
center conductor	solid SPC <sup>(1)</sup>	-	-
dielectric	low density PTFE <sup>(2)</sup>	-	-
inner shield	SPC tape	-	-
outer shield	SPC braid	-	-
jacket	green FEP <sup>(3)</sup>	max. 5.85	max. 0.230

- <sup>(1)</sup> SPC = Silver Plated Copper  
<sup>(2)</sup> PTFE = Poly TetraFluoroEthylene  
<sup>(3)</sup> FEP = Fluorinated Ethylene Propylene

**ELECTRICAL CHARACTERISTICS**

characteristic impedance	50 ohms ± 1 ohms	
operating frequency range	DC - 26.5 GHz	
cut-off frequency	31 GHz	
screening effectiveness	> 90 dB (at 18 GHz)	
velocity of propagation	85 %	
propagation time	3.9 ns / m	1.2 ns / ft
capacitance	79 pF / m (at 1 GHz)	23.9 pF / ft (at 1 GHz)
insulation resistance	> 3 x 10 <sup>5</sup> MOhm / m	
Corona extinction voltage	> 2.3 kV	
nominal phase	1400 ° / m / GHz	
phase stability with temperature	< 1° / m / GHz (-55 / +100°C)	
phase stability with bending	< 0.4° / 360° / GHz	
attenuation stability with bending	< 0.05 dB (at 18 GHz) / < 0.1 dB (at 26.5 GHz)	
attenuation stability with shaking	< 0.01 dB/m (at 18 GHz) / < 0.015 dB/m (at 26.5 GHz)	
atten. variation with temperature	Att. (at X° C) = att. (at 20° C) x 1 + (X - 20) x 0,002	



Radiall P/N : F1703159GR

**MECHANICAL CHARACTERISTICS**

maximum weight	73g / m	22.1g / ft
recommend. min. bend radius	25 mm	0.984 inch
crush resistance	> 700N / 100 mm	

**ENVIRONMENTAL CHARACTERISTICS**

operating temperature range	-70 / +200° C	-94 / +392° C
fire resistance	yes (MIL C 87104)	
halogen free jacket	no	

**APPLICATION NOTE**

This Ultra-low loss cable is fully adapted to laboratory applications. It can be reinforced with "ProJack" protective jacket for high mechanical stress applications.

**Main benefits:**

- ultra-low loss
- high electrical stability with bending and temperature
- high phase stability with temperature
- strain relief
- high mechanical strength and crush resistance
- broad range of connectors available

**FREQUENCY / ATTENUATION (typ.) / CW MAX POWER (\*)**

GHz	dB / m	dB / ft	Watts
1.0	0.23	0.07	850
2.0	0.32	0.10	600
4.0	0.46	0.14	420
6.0	0.57	0.17	340
8.0	0.66	0.20	300
10.0	0.75	0.23	270
12.4	0.84	0.25	240
18.0	1.02	0.31	200
26.5	1.27	0.38	190
attenuation calculation (dB/m)	(0.22 x √f GHz) + (0.005 x F GHz)		

(\*) = CW max power calculated at sea level / 40°C and VSWR 1:1 (Cable-assembly power ratings may be limited by the connector type. Please contact us for specific needs).  
 Note: typical attenuation for two connectors (dB) = 0.045 x √f GHz + 0.04

# CHARACTERISTICS



## CONSTRUCTION / DIMENSIONS

	material	mm	inches
center conductor	solid SPC <sup>(1)</sup>	-	-
dielectric	low density PTFE <sup>(2)</sup>	-	-
inner shield	SPC tape	-	-
outer shield	SPC braid	-	-
jacket	green FEP <sup>(3)</sup>	max. 8.50	max. 0.335

- <sup>(1)</sup> SPC = Silver Plated Copper
- <sup>(2)</sup> PTFE = Poly TetraFluoroEthylene
- <sup>(3)</sup> FEP = Fluorinated Ethylene Propylene

## ELECTRICAL CHARACTERISTICS

characteristic impedance	50 ohms ± 1 ohms	
operating frequency range	DC - 18 GHz	
cut-off frequency	20 GHz	
screening effectiveness	> 90 dB (at 18 GHz)	
velocity of propagation	85 %	
propagation time	3.9 ns / m	1.2 ns / ft
capacitance	79 pF / m (at 1 GHz)	23.9 pF / ft (at 1 GHz)
insulation resistance	> 3 x 10 <sup>5</sup> MOhm / m	
Corona extinction voltage	> 3.3 kV	
nominal phase	1400 ° / m / GHz	
phase stability with temperature	< 1° / m / GHz (-55 / +100°C)	
phase stability with bending	< 0.4° / 360° / GHz	
attenuation stability with bending	< 0.05 dB (at 18 GHz)	
attenuation stability with shaking	< 0.01 dB/m (at 18 GHz)	
atten. variation with temperature	Att. (at X° C) = att. (at 20° C) x 1 + (X - 20) x 0,002	



Radiall P/N : F1703160GR

## MECHANICAL CHARACTERISTICS

maximum weight	155g / m	47.0g / ft
recommend. min. bend radius	40 mm	1.575 inch
crush resistance	> 1000N / 100 mm	

## ENVIRONMENTAL CHARACTERISTICS

operating temperature range	-70 / +200° C	-94 / +392° C
fire resistance	yes (MIL C 87104)	
halogen free jacket	no	

### APPLICATION NOTE

This Ultra-low loss cable is fully adapted to laboratory applications. It can be reinforced with "ProJack" protective jacket for high mechanical stress applications.

#### Main benefits:

- ultra-low loss
- high electrical stability with bending and temperature
- high phase stability with temperature
- strain relief
- high mechanical strength and crush resistance
- broad range of connectors available

## FREQUENCY / ATTENUATION (typ.) / CW MAX POWER (\*)

GHz	dB / m	dB / ft	Watts
1.0	0.15	0.04	1600
2.0	0.21	0.06	1100
3.0	0.26	0.08	920
4.0	0.30	0.09	800
5.0	0.34	0.10	710
6.0	0.37	0.11	650
8.0	0.44	0.13	560
10.0	0.49	0.15	500
12.4	0.55	0.17	450
18.0	0.68	0.21	380
attenuation calculation (dB/m)	(0.14 x √F GHz) + (0,005 x F GHz)		

(\*) = CW max power calculated at sea level / 40°C and VSWR 1:1 (Cable-assembly power ratings may be limited by the connector type. Please contact us for specific needs).

Note: typical attenuation for two connectors (dB) = 0.0447 x √F GHz + 0.04

## PHASE STABLE TEST BENCH CABLE ASSEMBLIES

TestPro 4.2 standard assemblies meet the most common requested configurations suitable for test benches in production or labs due to their very long life and great stability in dynamic use.

In order to receive optimized service and price, select from the list of existing part numbers.

Part Number	Model		Length		Attenuation-Nom at 2GHz - at 18GHz	VSWR-Nom at 18GHz
R288940034	SMA male	SMA male	24 in.		0.47 dB - 1.51 dB	1.20
R288940001	SMA male	SMA male	36 in.		0.65 dB - 2.15 dB	1.20
R288940002	SMA male	SMA male	48 in.		0.83 dB - 2.79 dB	1.20
R288940003	SMA male	SMA male	72 in.		1.19 dB - 4.06 dB	1.20
R288940035	SMA male	N Type (*)	24 in.		0.47 dB - 1.51 dB	1.20
R288940004	SMA male	N Type (*)	36 in.		0.65 dB - 2.15 dB	1.25
R288940005	SMA male	N Type (*)	48 in.		0.83 dB - 2.79 dB	1.25
R288940006	SMA male	N Type (*)	72 in.		1.19 dB - 4.06 dB	1.25
R288940007	N Type (*)	N Type (*)	36 in.		0.65 dB - 2.15 dB	1.25
R288940008	N Type (*)	N Type (*)	48 in.		0.83 dB - 2.79 dB	1.25
R288940009	N Type (*)	N Type (*)	72 in.		1.19 dB - 4.06 dB	1.25
R288940010	PC7	PC7	36 in.		0.65 dB - 2.15 dB	1.30
R288940011	PC7	PC7	48 in.		0.83 dB - 2.79 dB	1.30
R288940012	PC7	PC7	72 in.		1.19 dB - 4.06 dB	1.30
R288940013	PC7	SMA male	36 in.		0.65 dB - 2.15 dB	1.30
R288940014	PC7	SMA male	48 in.		0.83 dB - 2.79 dB	1.30
R288940015	PC7	SMA male	72 in.		1.19 dB - 4.06 dB	1.30
R288940016	PC7	N Type (*)	36 in.		0.65 dB - 2.15 dB	1.30
R288940017	PC7	N Type (*)	48 in.	0.83 dB - 2.79 dB	1.30	
R288940018	PC7	N Type (*)	72 in.	1.19 dB - 4.06 dB	1.30	

All TestPro cable assemblies are delivered in individual packaging with attached test report.

\* One turn precision N Type connector

## VSWR AND POWER HANDLING

VSWR max	0-4 GHz		4-8 GHz		8-12.4 GHz		12.4-18 GHz		18-20 GHz	
	VSWR	dB	VSWR	dB	VSWR	dB	VSWR	dB	VSWR	dB
2 x SMA	1.12	25	1.20	21	1.20	21	1.25	19	1.27	18
2 x N	1.15	23	1.25	19	1.25	19	1.30	18	-	-
2 x PC7	1.25	19	1.30	18	1.30	18	1.35	16	-	-

This table gives values for assembly lengths between 200 to 5000 mm (8 to 196 in.)

MAXIMUM POWER HANDLING	VHF/UHF	L Band	S Band	C Band	X Band	Ku Band	K Band	
	1 GHz	2 GHz	4 GHz	8 GHz	12,4 GHz	18 GHz	20 GHz	26,5 GHz
20°C, SEA LEVEL (W)								
2 x SMA	550	295	210	150	115	80	70	-
2 x N	550	295	210	150	115	80	-	-
2 x PC7	550	295	210	150	115	80	-	-

## TEMPERATURE DERATING

Attenuation at X°C = Attenuation (20°C) x (1 + (X - 20) x q). Ex: q = 0.002 for copper and silver

## ULTRA LOW LOSS TEST AND MEASUREMENT CABLE ASSEMBLIES

TestPro 5 and TestPro 8 standard assemblies are required when loss become an issue. Their high stability with temperature make them easy to use in temperature chambers. They are also suitable for high power applications.

In order to receive optimized service and price, select from the list of existing part numbers.

Part Number	Model		Length		Attenuation-Nom at 2GHz - at 18GHz	VSWR-Nom at 18GHz
<b>TestPro 5</b>						
R288931001	SMA male	SMA male	39.4 in.		0.42 dB - 1.25 dB	1.20
R288931002	N Type	N Type	39.4 in.		0.42 dB - 1.25 dB	1.25
R288931003	N Type	SMA male	39.4 in.		0.42 dB - 1.25 dB	1.25
<b>TestPro 8</b>						
R288931004	SMA male	SMA male	39.4 in.		0.31 dB - 0.91 dB	1.25
R288931005	N Type	N Type	39.4 in.		0.31 dB - 0.91 dB	1.25
R288931006	N Type	SMA male	39.4 in.		0.31 dB - 0.91 dB	1.25

All TestPro cable assemblies are delivered in individual packaging with attached test report.

## VSWR AND POWER HANDLING

VSWR max	0-4 GHz		4-8 GHz		8-12.4 GHz		12.4-18 GHz		18-26.5 GHz		
	VSWR	dB	VSWR	dB	VSWR	dB	VSWR	dB	VSWR	dB	
<b>TestPro 5</b>	2 x SMA	1.15	23	1.20	21	1.20	21	1.25	19	1.27	18
	2 x TNC	1.20	21	1.30	18	1.30	18	1.35	17	-	-
	2 x N	1.20	21	1.25	19	1.25	19	1.30	18	-	-
<b>Testpro 8</b>	VSWR	dB	VSWR	dB	VSWR	dB	VSWR	dB	VSWR	dB	
	2 x SMA	1.15	23	1.20	21	1.20	21	1.25	19	-	-
	2 x TNC	1.20	21	1.30	18	1.30	18	1.35	17	-	-
	2 x N	1.20	21	1.25	19	1.25	19	1.30	18	-	-

This table gives value for assembly lengths between 200 to 5000 mm (8 to 196 in.)

MAXIMUM POWER HANDLING, 20°C, SEA LEVEL (W)		VHF/UHF	L Band	S Band	C Band	X Band	Ku Band	K Band	
		1 GHz	2 GHz	4 GHz	8 GHz	12,4 GHz	18 GHz	20 GHz	26,5 GHz
Testpro 5	2 x SMA	450	330	240	180	145	130	120	105
	2 x N	495	360	270	200	160	140	-	-
	2 x PC7	750	520	360	250	200	160	-	-
TestPro 8	2 x SMA	520	390	280	210	170	145	-	-
	2 x N	585	430	315	235	195	160	-	-
	2 x PC7	870	610	420	300	235	200	-	-

## TEMPERATURE DERATING

Attenuation at X°C = Attenuation (20°C) x (1 + (X - 20) x q). Ex: q = 0.002 for copper and silver

Many applications require specific assemblies. The Radiall TestPro range is available in custom lengths and configurations. Use the following pages to select cable and connectors to meet your needs and send us your request for quotation.

## HOW TO ORDER

### Select the right TestPro cable.

- TestPro 4.2 “Phase Stable” is suitable for test benches in production or labs due to its long life and great stability in dynamic use.
- TestPro 5 & 8 “Ultra Low Loss” allows the use of long length cables with remote test stations and anechoic chambers. Their high stability with temperature makes them easy to use in temperature chambers. They are also suitable for high power applications.

Properties	TestPro 4.2	TestPro 5	TestPro 8
	Phase Stable	Ultra Low Loss	
Frequency range	DC - 20GHz	DC - 26.5GHz	DC - 18GHz
Impedance	50 Ω ± 2 Ω	50 Ω ± 1 Ω	50 Ω ± 1 Ω
IL (dB/m at 2 GHz - at 18 GHz)	0.54 - 1.90	0.32 - 1.02	0.21 - 0.68
IL (dB/ft at 2 GHz - at 18 GHz)	0.16 - 0.58	0.10 - 0.31	0.06 - 0.21
Phase with flexure stability	2° at 18 GHz	7° at 18 GHz	7° at 18 GHz
Amplitude stability (dB at 18GHz)	< 0,02	< 0,05	< 0,05
Shielding Effectiveness (at 1GHz)	-110 dB min	-110 dB min	-110 dB min
Crush resistance (N/100 mm)	2300	700	1000
Minimum bend radius	25 mm (1 in.)	25 mm (1 in.)	40 mm (1.57 in.)
Temperature (°C)	-55 / + 105 °C	-70 / + 125 °C	-70 / + 125 °C
Phase matching	-	By set, with master or per absolute phase, available with a typical phase matching of +/-0.4°/GHz	
Connectors	SMA, N, PC7	SMA, N, TNC	SMA, N, TNC
Flexure life cycle	10,000	5,000	5,000
Mating cycles durability	5,000	5,000	5,000
Armor	Available	Available	Available

See details cable characteristics on page 6 to 8.

### Select armor option for reinforced cable assemblies.

“ProJack” protect lab cable assemblies for greater life time. It is also dedicated for all defense systems tests running outdoors. See details protective jacket characteristics on page 12.

### Select connectors.

Select the right connectors compatible with your choice of TestPro cable on page 13 to 17.

Send quote requests to your Radiall sales contact.

You may also use our cable assembly builder at [www.radiall.com/cableassembly](http://www.radiall.com/cableassembly)

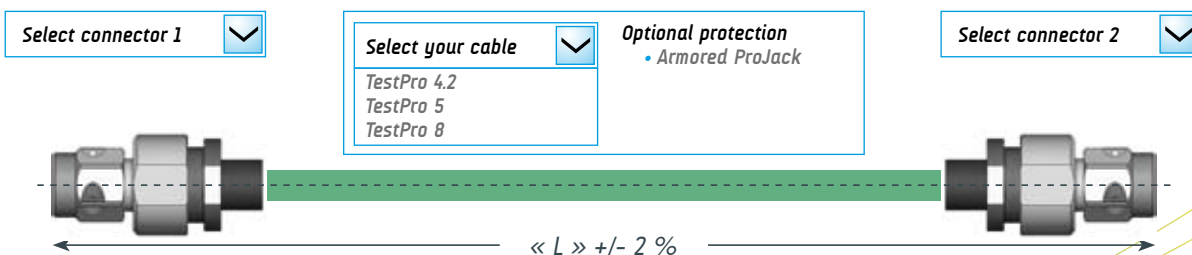





## PROJACK

### APPLICATION NOTE

**Main benefits:**

- high mechanical protection (resistance to crush, traction, abrasion, ...)
- high flexibility
- anti-torque
- strain relief
- anti-kinking action
- secured watertightness when used with compound chamber

Radiall P/N : G940RP10 - G941RP10

### CONSTRUCTION

	Material
Spring	Stainless steel
Braid	Stainless steel
Jacket	Black PU

### MECHANICAL CHARACTERISTICS

	For TestPro 4.2 and TestPro 5	For TestPro 8
Outer dia. (max)	11 mm (0.433 in.)	15 mm (0.590 in.)
Maximum weight	340 g/m (103 g/ft)	190 g/m (57.6 g/ft)
Recommend. min. bend radius	25 mm	38 mm
Crush resistance	2 500 N / 100 mm	
Tensile strength	900 N	

### ENVIRONMENTAL CHARACTERISTICS

Operating temperature range	-55 / +100 °C (-67 / +212° F)
Fire resistance	yes (FAR 25 853)
Halogen free jacket	no

Connector part numbers are for reference only. Connectors and cables cannot be ordered separately.

## SMA SERIES

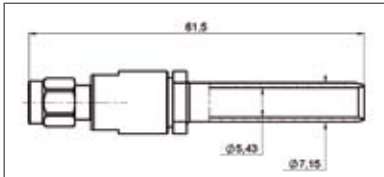

<b>Designation</b>	<b>Straight Plug</b>
Item	M125064C00
Max. Freq	20 GHz
VSWR ≤ 18 GHz	1.25

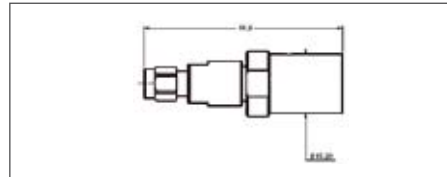

<b>Designation</b>	<b>Straight Plug For ProJack</b>
Item	M125064C01
Max. Freq	20 GHz
VSWR ≤ 18 GHz	1.25

### SMA Series characteristics.

Voltage withstanding 750 Vrms  
 Connector material is stainless steel.  
 Finish is passivated  
 Temperature range with TestPro cables = -55 / +105 °C  
 Nominal coupling nut torque si 110 N  
 (recommended torque wrench for plugs: R282320000 / 8 mm / 80-120 Ncm)

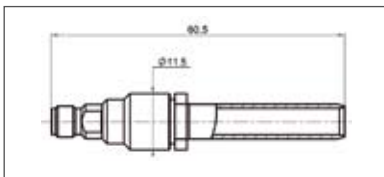

<b>Designation</b>	<b>Straight Jack</b>
Item	M125207C00
Max. Freq	20 GHz
VSWR ≤ 18 GHz	1.25

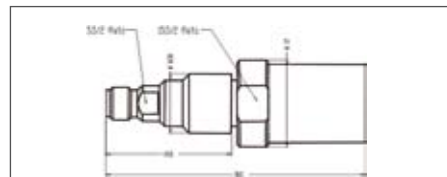

<b>Designation</b>	<b>Straight Jack For ProJack</b>
Item	M125207C01
Max. Freq	20 GHz
VSWR ≤ 18 GHz	1.25

## N SERIES

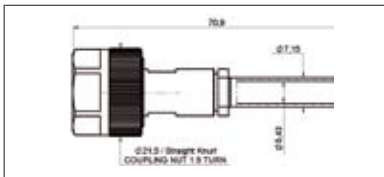

<b>Designation</b>	<b>Straight Plug</b>
Item	M163064C00
Max. Freq	18 GHz
VSWR ≤ 18 GHz	1.30

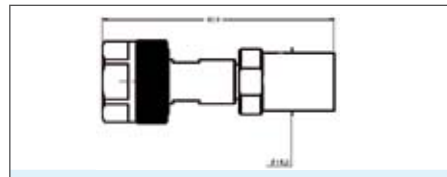

<b>Designation</b>	<b>Straight Plug For ProJack</b>
Item	M163064C01
Max. Freq	18 GHz
VSWR ≤ 18 GHz	1.30

### N Series characteristics.

Voltage withstanding 750 Vrms  
 Connector material is stainless steel.  
 Finish is passivated  
 Temperature range with TestPro cables = -55 / +105 °C  
 Nominal coupling nut torque si 400 N  
 (recommended torque wrench for plugs: R282 303 000 / 19 mm / 160 Ncm)

## PC7 SERIES

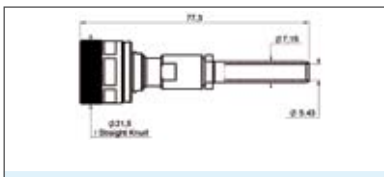

<b>Designation</b>	<b>Straight Plug</b>
Item	M151064C00
Max. Freq	18 GHz
VSWR ≤ 18 GHz	1.30

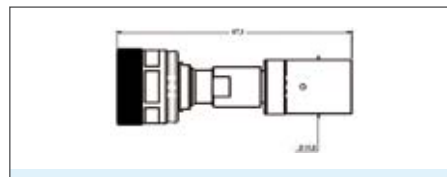

<b>Designation</b>	<b>Straight Plug For ProJack</b>
Item	M151064C01
Max. Freq	18 GHz
VSWR ≤ 18 GHz	1.30

### PC7 Series characteristics.

Voltage withstanding 750 Vrms  
 Connector material is stainless steel.  
 Finish is passivated  
 Temperature range with TestPro cables = -55 / +105 °C

Connector part numbers are for indication only. Connectors and cables cannot be ordered separately.

### SMA 2.9 series

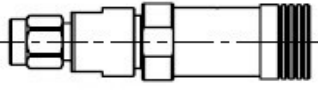
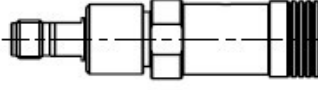
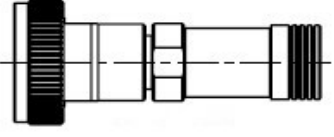
			
Designation	<b>Straight Plug</b>	Designation	<b>Straight Jack</b>
Item	R127801321	Item	R127822111
Max. Freq	40 GHz	Max. Freq	40 GHz
VSWR ≤ 40 GHz	1.40	VSWR ≤ 40 GHz	1.40
			
Designation	<b>NMD 2.9 port femal</b>		
Item	R299776101		
Max. Freq	40 GHz		
VSWR ≤ 40 GHz	1.40		

**SMA 2.9 Series characteristics.**  
 Voltage withstanding 750 Vrms  
 Connector material is stainless steel.  
 Finish is passivated  
 Temperature range = -55 / +105 °C  
 Nominal coupling nut torque si 110 N  
 Recommended torque wrench for plugs :  
 R282 320 000 / 8 mm / 80-120 Ncm

### SMA 2.9 series Vented connectors

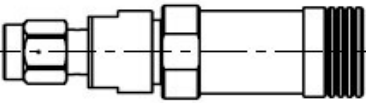
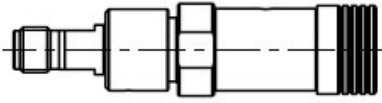
			
Designation	<b>Straight Plug</b>	Designation	<b>Straight Jack</b>
Item	R127801311	Item	R127822101
Max. Freq	40 GHz	Max. Freq	40 GHz
VSWR ≤ 40 GHz	1.40	VSWR ≤ 40 GHz	1.40

CONNECTORS COMPATIBLE WITH

Connector part numbers are for indication only. Connectors and cables cannot be ordered separately.

SMA 2.9 series

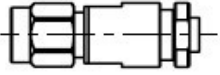
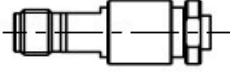
			
Designation	Straight Plug	Designation	Straight Jack
Item	R127801311	Item	R127822121
Max. Freq	40 GHz	Max. Freq	40 GHz
VSWR ≤ 40 GHz	1.40	VSWR ≤ 40 GHz	1.40

**SMA 2.9 Series characteristics.**  
 Voltage withstanding 750 Vrms  
 Connector material is stainless steel.  
 Finish is passivated  
 Temperature range = -55 / +105 °C  
 Nominal coupling nut torque si 110 N  
 Recommended torque wrench for plugs :  
 R282 320 000 / 8 mm / 80-120 Ncm

# CONNECTORS COMPATIBLE WITH



Connector part numbers are for reference only. Connectors and cables cannot be ordered separately.

## SMA SERIES

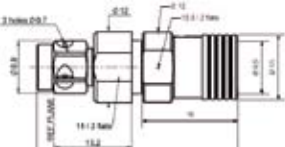
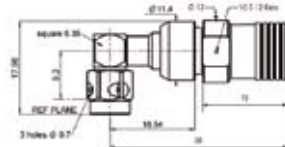
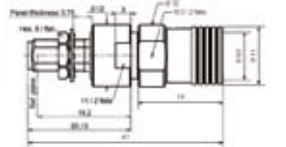
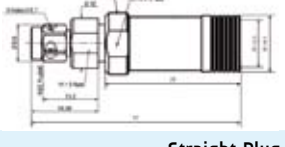
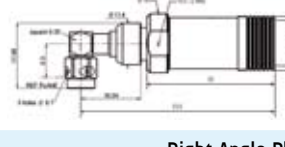
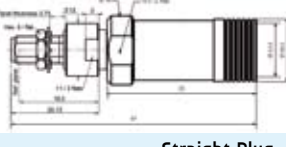
		
<b>Designation</b> Straight Plug	<b>Designation</b> Right Angle Plug	<b>Designation</b> Straight Jack
Item M125065L02 Max. Freq 26.5 GHz VSWR ≤ 18 GHz 1.25 ≤ 26.5 GHz 1.30	Item M125195L02 Max. Freq 18 GHz VSWR ≤ 18 GHz 1.30	Item M125330L02 Max. Freq 26.5 GHz 1.25 VSWR ≤ 18 GHz 1.30 ≤ 26.5 GHz 1.30 Miscellaneous Panel sealed panel nut torque 200N
		
<b>Designation</b> Straight Plug For ProJack	<b>Designation</b> Right Angle Plug For ProJack	<b>Designation</b> Straight Plug For ProJack
Item M125065L03 Max. Freq 26.5 GHz 1.25 VSWR ≤ 18 GHz 1.30 ≤ 26.5 GHz 1.30	Item M125195L03 Max. Freq 18 GHz 1.30 VSWR ≤ 18 GHz 1.30	Item M125330L03 Max. Freq 26.5 GHz 1.25 VSWR ≤ 18 GHz 1.30 ≤ 26.5 GHz 1.30 Miscellaneous Panel sealed panel nut torque 200N

### SMA Series characteristics.

Voltage withstanding 1000 Vrms. Connector material is stainless steel 316L. Finish is passivated. Temperature range with TestPro cables = -55 / +130 °C. Nominal coupling nut torque si 110 N (recommended torque wrench for plugs: R282320000 / 8 mm / 80-120 Ncm)

## TNC SERIES

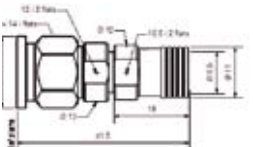
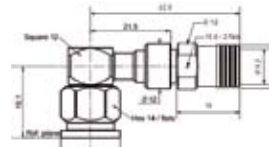
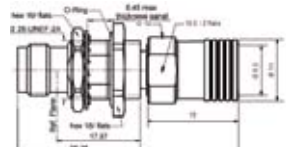
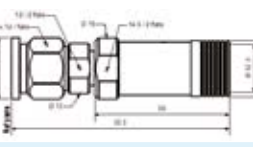
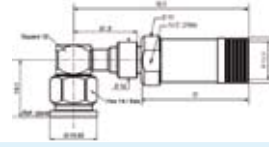
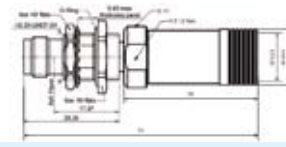
		
<b>Designation</b> Straight Plug	<b>Designation</b> Right Angle Plug	<b>Designation</b> Straight Jack
Item M143065L02 Max. Freq 18 GHz VSWR ≤ 18 GHz 1.30	Item M143195L02 Max. Freq 18 GHz VSWR ≤ 18 GHz 1.30	Item M143330L02 Max. Freq 18 GHz VSWR ≤ 18 GHz 1.30 Miscellaneous Panel sealed panel nut torque 200N
		
<b>Designation</b> Straight Plug For ProJack	<b>Designation</b> Right Angle Plug For ProJack	<b>Designation</b> Straight Plug For ProJack
Item M143065L03 Max. Freq 26.5 GHz 1.25 VSWR ≤ 18 GHz 1.30 ≤ 26.5 GHz 1.30	Item M143195L03 Max. Freq 18 GHz 1.30 VSWR ≤ 18 GHz 1.30	Item M125330L03 Max. Freq 18 GHz 1.30 VSWR ≤ 18 GHz 1.30 Miscellaneous Panel sealed panel nut torque 370N

### TNC Series characteristics.

Voltage withstanding 1500 Vrms. Connector material is stainless steel 316 L. Finish is passivated. Temperature range with TestPro cables = -55 / +130 °C. Nominal coupling nut torque si 330 N (recommended torque wrench for plugs: R282300000 / 14 mm / 265 Ncm)



Connector part numbers are for reference only. Connectors and cables cannot be ordered separately.

**N 18 SERIES**

<b>Designation</b> <b>Straight Plug</b>	<b>Designation</b> <b>Right Angle Plug</b>	<b>Designation</b> <b>Straight Jack</b>
Item <b>M163065L02</b> Max. Freq              18 GHz VSWR ≤ 18 GHz      1.30	Item <b>M163195L02</b> Max. Freq              18 GHz VSWR ≤ 18 GHz      1.30	Item <b>M163325L02</b> Max. Freq              18 GHz VSWR ≤ 18 GHz      1.25 Miscellaneous      Panel sealed panel nut torque 500N
<b>Designation</b> <b>Straight Plug For ProJack</b>	<b>Designation</b> <b>Right Angle Plug For ProJack</b>	<b>Designation</b> <b>Straight Plug For ProJack</b>
Item <b>M163065L03</b> Max. Freq              26.5 GHz VSWR ≤ 18 GHz      1.25	Item <b>M163195L03</b> Max. Freq              18 GHz VSWR ≤ 18 GHz      1.30	Item <b>M163325L03</b> Max. Freq              18 GHz VSWR ≤ 18 GHz      1.25 Miscellaneous      Panel sealed panel nut torque 500N

**N 18 Series characteristics.**

Voltage withstanding 1500 Vrms. Connector material is stainless steel 316L. Finish is passivated. Temperature range with TestPro cables = -55 / +130 °C. Nominal coupling nut torque si 400 N (recommended torque wrench for plugs: R282303000 / 19 mm / 160 Ncm)

# CONNECTORS COMPATIBLE WITH



Connector part numbers are for reference only. Connectors and cables cannot be ordered separately.

## SMA SERIES

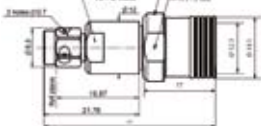
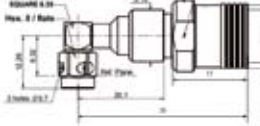
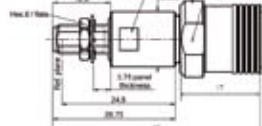
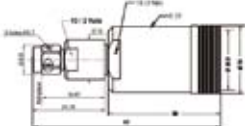
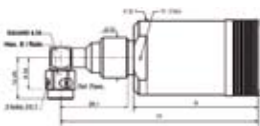
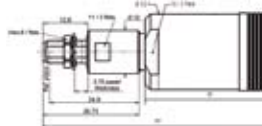
		
<b>Designation</b> Straight Plug	<b>Designation</b> Right Angle Plug	<b>Designation</b> Straight Jack
Item <b>M125068L04</b> Max. Freq 18 GHz VSWR ≤ 18 GHz	Item <b>M125199L04</b> Max. Freq 18 GHz VSWR ≤ 18 GHz	Item <b>M125338L04</b> Max. Freq 26,5 GHz VSWR ≤ 18 GHz Miscellaneous Panel sealed panel nut torque 250N
		
<b>Designation</b> Straight Plug For ProJack	<b>Designation</b> Right Angle Plug For ProJack	<b>Designation</b> Straight Plug For ProJack
Item <b>M125068L05</b> Max. Freq 18 GHz VSWR ≤ 18 GHz	Item <b>M125199L05</b> Max. Freq 18 GHz VSWR ≤ 18 GHz	Item <b>M125338L05</b> Max. Freq 18 GHz VSWR ≤ 18 GHz Miscellaneous Panel sealed panel nut torque 250N

### SMA Series characteristics.

Voltage withstanding 1000 Vrms. Connector material is stainless steel 316L. Finish is passivated. Temperature range with TestPro cables = -55 / +130 °C. Nominal coupling nut torque si 110 N (recommended torque wrench for plugs: R28220000 / 8 mm / 80-120 Ncm)

## TNC SERIES

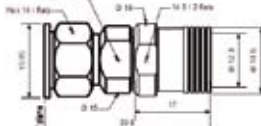
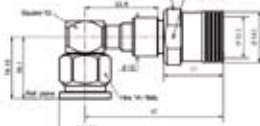
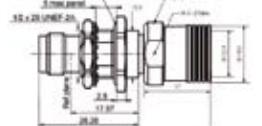
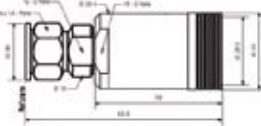
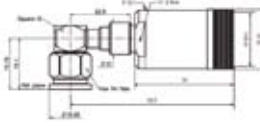
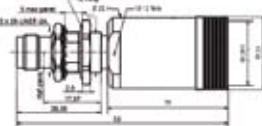
		
<b>Designation</b> Straight Plug	<b>Designation</b> Right Angle Plug	<b>Designation</b> Straight Jack
Item <b>M143068L04</b> Max. Freq 18 GHz VSWR ≤ 18 GHz	Item <b>M143198L04</b> Max. Freq 18 GHz VSWR ≤ 18 GHz	Item <b>M143338L04</b> Max. Freq 18 GHz VSWR ≤ 18 GHz Miscellaneous Panel sealed panel nut torque 370N
		
<b>Designation</b> Straight Plug For ProJack	<b>Designation</b> Right Angle Plug For ProJack	<b>Designation</b> Straight Plug For ProJack
Item <b>M143068L05</b> Max. Freq 18 GHz VSWR ≤ 18 GHz	Item <b>M143198L05</b> Max. Freq 18 GHz VSWR ≤ 18 GHz	Item <b>M143338L05</b> Max. Freq 18 GHz VSWR ≤ 18 GHz Miscellaneous Panel sealed panel nut torque 370N

### TNC Series characteristics.

Voltage withstanding 1500 Vrms. Connector material is stainless steel 316 L. Finish is passivated. Temperature range with TestPro cables = -55 / +130 °C. Nominal coupling nut torque si 330 N (recommended torque wrench for plugs: R282300000 / 14 mm / 265 Ncm)

Connector part numbers are for reference only. Connectors and cables cannot be ordered separately.

**N 18 SERIES**

<b>Designation</b> Straight Plug Item <b>M163068L04</b> Max. Freq 18 GHz VSWR ≤ 18 GHz 1.25	<b>Designation</b> Right Angle Plug Item <b>M163198L04</b> Max. Freq 18 GHz VSWR ≤ 18 GHz 1.30	<b>Designation</b> Straight Jack Item <b>M163328L04</b> Max. Freq 18 GHz VSWR ≤ 18 GHz 1.25 Miscellaneous Panel sealed panel nut torque 500N
<b>Designation</b> Straight Plug For ProJack Item <b>M163068L05</b> Max. Freq 18 GHz VSWR ≤ 18 GHz 1.25	<b>Designation</b> Right Angle Plug For ProJack Item <b>M163198L05</b> Max. Freq 18 GHz VSWR ≤ 18 GHz 1.30	<b>Designation</b> Straight Plug For ProJack Item <b>M163328L05</b> Max. Freq 18 GHz VSWR ≤ 18 GHz 1.25 Miscellaneous Panel sealed panel nut torque 500N

**N 18 Series characteristics.**

Voltage withstanding 1500 Vrms. Connector material is stainless steel 316L. Finish is passivated. Temperature range with TestPro cables = -55 / +130 °C. Nominal coupling nut torque si 400 N (recommended torque wrench for plugs: R282303000 / 19 mm / 160 Ncm)

## IN-SERIES ADAPTORS (DC-18 GHZ)



Interface	Male - Male	Male - Female	Female - Female	Miscellaneous
SMA	R125703000	R125704000	R125705000	Gold plated stainless steel Passivated stainless steel
	R125703001	R125704001	R125705001	
TNC 18	R143703700	R143705700	R143704700 R143710700 R143730700	Square flange Bulkhead
N 18	R163703701	R163708701	R163705701	silicon gasket
	R163703001	R163708001	R163705001	

## BETWEEN SERIES ADAPTORS (DC-18 GHZ)



Interface		Part Number	N 18		
			Male	Female	Female bulkhead panel sealed
SMA	Male	R191009000			
	Female	R191011000			
PC 3,5	Male	R191010000	R191324000	R191326000	R191333000
	Female	R191012000	R191328000	R191330000	
TNC	Male	R191017000			
	Female	R191019000			
TNC 18	Male	R191017700			
	Female	R191019700			

## ATTENUATORS (DC-18GHZ)



Interface	Part Number	Attenuation (dB)	Power (W)	Miscellaneous
SMA	R4118XX121	0 to 30	2	Flat frequency response Flat frequency response Flat frequency response
	R4138XX000	0 to 60	2	
	R4161XX000	3 to 20	10 to 15	
TNC	R4145XX161	0 to 20	2	
	R4168XX000	3 to 20	10 to 15	
N	R4147XX161	0 to 20	2	
	R4160XX000	3 to 20	10 to 15	

## LOADS (DC-18 GHZ)



Interface	Part Number	Gender	Power (W)	Miscellaneous
SMA	R404210000	Male	2	With cord
	R404210120	Male	2	
	R404215000	Female	2	
	R404523000	Male	6	
	R404523500	Female	6	
	R404573000	Male	12	
	R404573500	Female	12	
	R404589000	Male	20	
	R404589500	Female	20	
	TNC	R404370000	Male	
R404370120		Male	2	
R404375000		Female	2	
R404521000		Male	6	
R404521500		Female	6	
R404571000		Male	12	
R404571500		Female	12	
R404586000		Male	20	
R404586500		Female	20	
N		R404340000	Male	2
	R404340120	Male	2	
	R404355000	Female	2	
	R404522000	Male	6	
	R404522500	Female	6	
	R404572000	Male	12	
	R404572500	Female	12	
	R404588000	Male	20	
	R404588500	Female	20	

 Click on any line to go to the page.

Part number	Page	Part number	Page	Part number	Page
F1703159GR	7	ProJack	12	R288940015	9
F1703160GR	8			R288940016	9
F1100001	6	R125703000	19	R288940017	9
		R125703001	19	R288940018	9
		R125704000	19		
		R125704001	19	R404210000	19
		R125705000	19	R404210120	19
		R125705001	19	R404215000	19
G940RP10	12	R143703700	19	R404340000	19
G941RP10	12	R143704700	19	R404340120	19
		R143705700	19	R404355000	19
M125064C00	13	R143710700	19	R404370000	19
M125064C01	13	R143730700	19	R404370120	19
M125065L02	14	R163703001	19	R404375000	19
M125065L03	14	R163703701	19	R404521000	19
M125068L04	16	R163705001	19	R404521500	19
M125068L05	16	R163705701	19	R404522000	19
M125195L02	14	R163708001	19	R404522500	19
M125195L03	14	R163708701	19	R404523000	19
M125199L04	16	R191009000	19	R404523500	19
M125199L05	16	R191010000	19	R404571000	19
M125330L02	14	R191011000	19	R404571500	19
M125330L03	14	R191012000	19	R404572000	19
M125338L04	16	R191017000	19	R404572500	19
M125338L05	16	R191017700	19	R404573000	19
M143065L02	14	R191019000	19	R404573500	19
M143065L03	14	R191019700	19	R404586000	19
M143068L04	16	R191324000	19	R404586500	19
M143068L05	16	R191326000	19	R404588000	19
M143195L02	14	R191328000	19	R404588500	19
M143195L03	14	R191330000	19	R404589000	19
M143198L04	16	R191333000	19	R404589500	19
M143198L05	16			R4118XX121	19
M143330L02	14	R288931001	10	R4138XX000	19
M143330L03	14	R288931002	10	R4145XX161	19
M143338L04	16	R288931003	10	R4147XX161	19
M143338L05	16	R288931004	10	R4160XX000	19
M151064C00	13	R288931005	10	R4161XX000	19
M151064C01	13	R288931006	10	R4168XX000	19
M163064C00	13	R288940001	9		
M163064C01	13	R288940002	9	TestPro 4.2	6
M163065L02	15	R288940003	9	TestPro 5	7
M163065L03	15	R288940004	9	TestPro 8	8
M163068L04	17	R288940005	9		
M163068L05	17	R288940006	9		
M163195L02	15	R288940007	9		
M163195L03	15	R288940008	9		
M163198L04	17	R288940009	9		
M163198L05	17	R288940010	9		
M163325L02	15	R288940011	9		
M163325L03	15	R288940012	9		
M163328L04	17	R288940013	9		
M163328L05	17	R288940014	9		