

PAGE 1/2	ISSUE 26-05-20A	SERIES ATTENUATOR	PART NUMBER R422106030
----------	-----------------	----------------------	------------------------

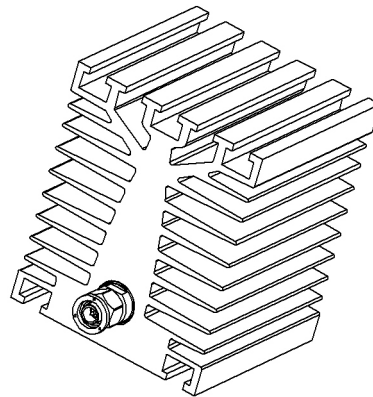

All dimensions are in mm. Tolerances according ISO 2768 m-H

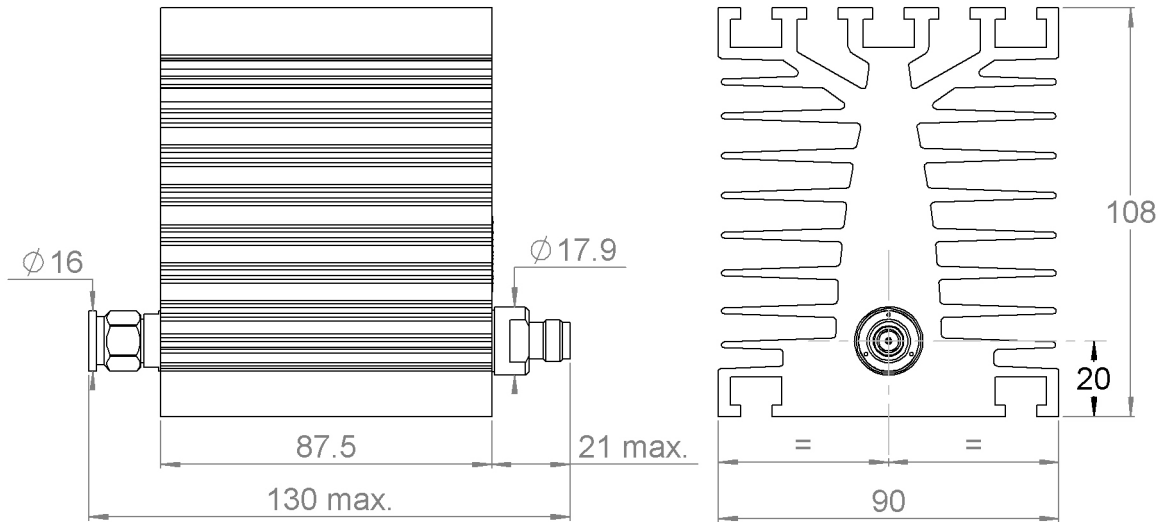
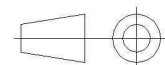

COMPONENTS	MATERIALS	PLATING (µm)
Body	<b>STAINLESS STEEL</b>	<b>PASSIVATED.</b>
Male center contact	<b>BERYLLIUM COPPER</b>	<b>GOLD 0.5 OVER NICKEL PHOSPHORUS 2</b>
Female center contact	<b>BERYLLIUM COPPER</b>	<b>GOLD 0.5 OVER NICKEL PHOSPHORUS 2</b>
Outer contact		
Insulator	<b>PTFE</b>	
Gasket	<b>SILICONE RUBBER</b>	
Substrate	<b>ALUMINIUM NITRIDE</b>	
Resistor	<b>THICK FILM</b>	
Others parts	<b>ALUMINIUM</b>	<b>BLACK ANODIZATION</b>

PAGE 2/2	ISSUE <b>26-05-20A</b>	SERIES <b>ATTENUATOR</b>	PART NUMBER <b>R422106030</b>
----------	------------------------	-----------------------------	-------------------------------

**ELECTRICAL CHARACTERISTICS**

Frequency (GHz)	<b>DC - 6</b>
V.S.W.R ( $\leq$ )	<b>1.25</b>
Deviation( $\pm$ dB)	<b>0.75</b>

Operating Frequency Range	<b>DC - 6</b>	GHz
Impedance	<b>50</b>	$\Omega$
Nominal Attenuation	<b>6</b>	dB
Peak power at 25°C (1 $\mu$ s, 1%)	<b>2000</b>	W
Average power at 25°C	<b>100</b>	W (Free Air Cooled)
		W (Conduction Cooled)

**MECHANICAL CHARACTERISTICS**

Connectors	<b>TNC</b>	<b>Male Female</b>	<b>MIL C39012</b>
Weight	<b>1187,36 g</b>		

**ENVIRONMENTAL CHARACTERISTICS**

Operating temperature range	<b>-55/+125</b> °C
Storage temperature range	<b>-55/+125</b> °C

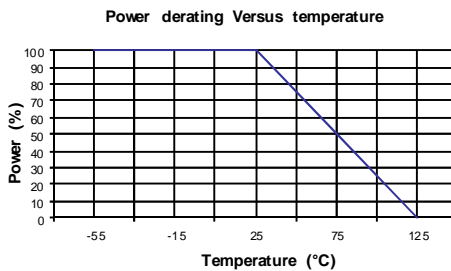

**SPECIFICATION**

**OTHER CHARACTERISTICS**