

PAGE 1/2	ISSUE 22-06-20A	SERIES COUPLER	PART NUMBER R433611700
----------	-----------------	-------------------	------------------------

Scale 2 : 1

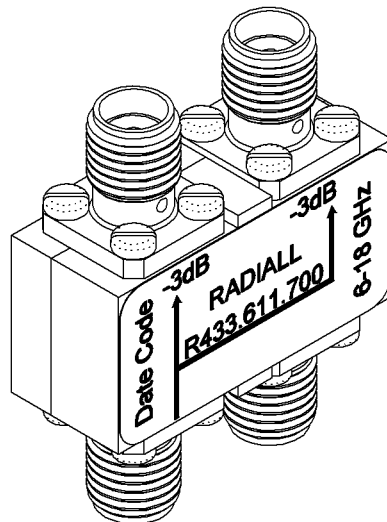

All dimensions are in mm. Tolerances according ISO 2768 m-H

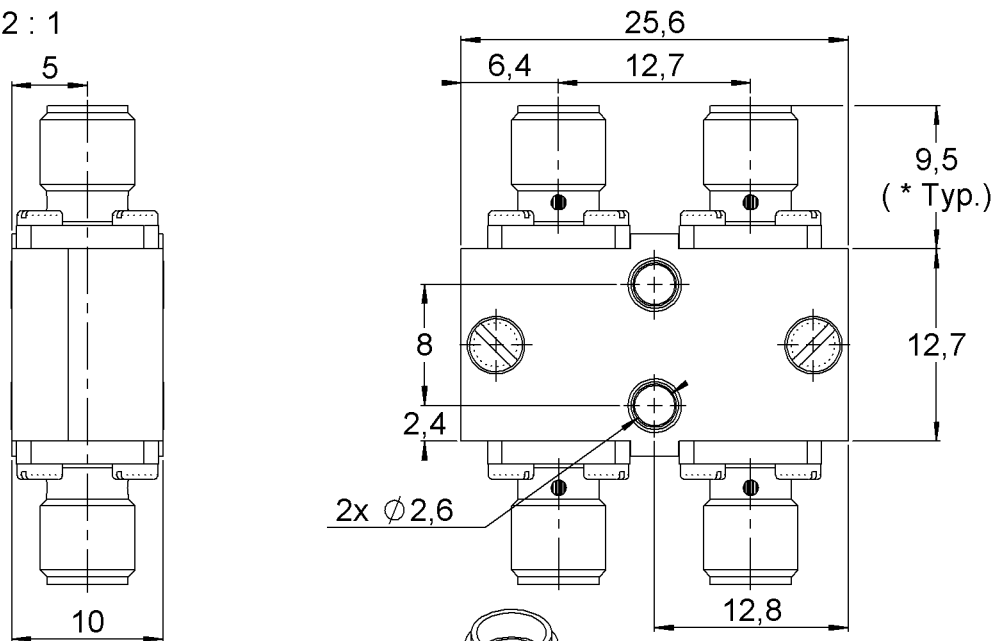

Weight **12,1700** g
Specification

ELECTRICAL CHARACTERISTICS

Frequency operating range :	6 – 18 GHz
Impedance :	50 Ω
VSWR :	1.50 max.
Nominal Coupling :	3 dB
Insertion Loss :	0.75 dB max.
Isolation :	15 dB mini
Amplitude Balance :	± 0.6 dB
Phase Balance :	$90^\circ \pm 6^\circ$
Average Power at 25°C	30W
Peak Power at 25°C	3000W

MECHANICAL CHARACTERISTICS

Connector type :	SMA female per MIL-C 39012
------------------	----------------------------

ENVIRONMENTAL CHARACTERISTICS

Operating temperature :	-40°C / +100°C
Storage temperature :	-40°C / +100°C