

PAGE 1/2

ISSUE 17.12.13

SERIE : SPnT

PART NUMBER : R574F02430

## RF CHARACTERISTICS

Number of ways : 4  
 Frequency range : 0 - 26.5 GHz  
 Impedance : 50 Ohms

Frequency (GHz)	DC - 3	3 - 8	8 - 12.4	12.4 - 18	18-26.5
VSWR max	1,20	1,30	1,40	1,50	1,70
Insertion loss max	0.20 dB	0.30 dB	0.40 dB	0.50 dB	0.70 dB
Isolation min	80 dB	70 dB	60 dB	60 dB	50 dB
Average power (*)	240 W	150 W	120 W	100 W	40 W

TERMINATION IMPEDANCE : 50 Ohms  
 TERM. AVG. POWER AT 25° C : 1 W per termination / 3 W total power

## ELECTRICAL CHARACTERISTICS

Actuator : NORMALLY OPEN  
 Nominal current \*\* : 250 mA  
 Actuator voltage (Vcc) : 12V (10.2 to 13V) / NEGATIVE COMMON  
 Terminals : solder pins (250°C max. / 30 sec.)

## MECHANICAL CHARACTERISTICS

Connectors : SMA female per MIL-C 39012  
 Life : 2.000.000 cycles per position  
 Switching Time\*\*\* : < 15 ms  
 Construction : Splashproof  
 Weight : < 250 g

## ENVIRONMENTAL CHARACTERISTICS

Operating temperature range : -40°C to +85°C  
 Storage temperature range : -55°C to +85°C

(\* Average power at 25°C per RF Path)

(\*\* At 25° C ±10%)

(\*\*\* Nominal voltage ; 25° C)



PAGE 2/2

ISSUE 17.12.13

SERIE : SPnT

PART NUMBER : R574F02430

DRAWING

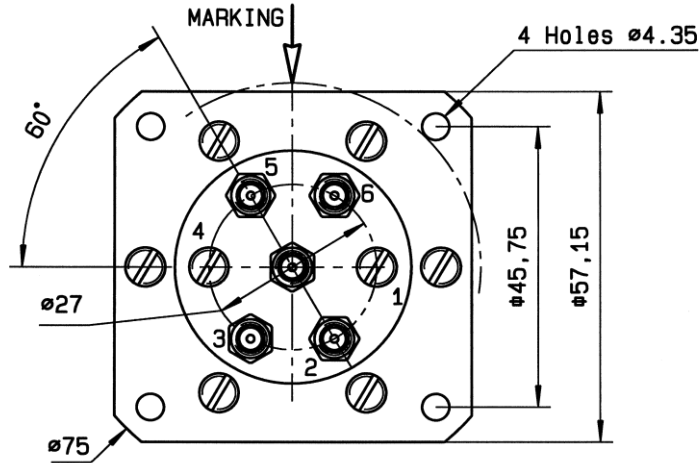

Voltage	RF Continuity
-C +2	IN ↔ 2
-C +3	IN ↔ 3
-C +5	IN ↔ 5
-C +6	IN ↔ 6

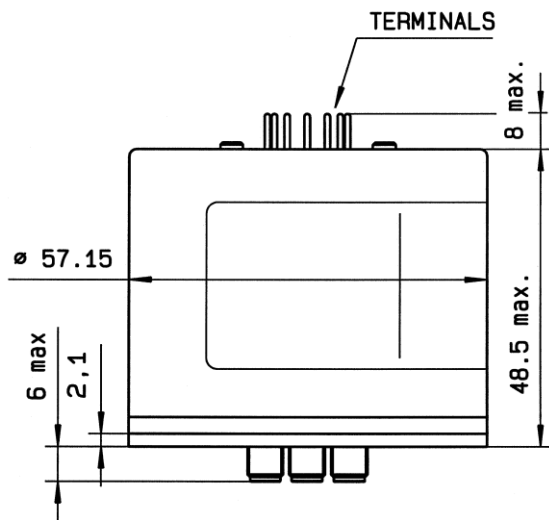

**LABEL**

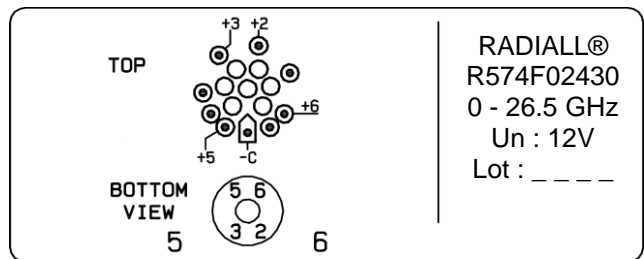

General tolerances : ±0.5 mm

SCHEMATIC DIAGRAM

