

## RL78/I1C

R01DS0281EJ0211

RENESAS MCU

Rev.2.11

Nov 30, 2022

True Low Power Platform, Independent power supply RTC, Hardware AES, 32-bit MAC, 1.9 V to 5.5 V operation, 64 to 256 Kbyte Flash, for Electric AMI Power Meter Application

## 1. OUTLINE

### 1.1 Features

#### Target application

- Power meters

#### Ultra-low power consumption technology

- $V_{DD}$  = single power supply voltage of 1.7 to 5.5 V<sup>Note 1</sup>
- HALT mode
- STOP mode
- SNOOZE mode

#### RL78 CPU core

- CISC architecture with 3-stage pipeline
- Minimum instruction execution time: Can be changed from high speed (0.03125  $\mu$ s: @ 32 MHz selection with PLL clock, 0.04167  $\mu$ s: @ 24 MHz selection with high-speed on-chip oscillator) to ultra-low speed (66.6  $\mu$ s: @ 15 kHz operation with low-speed on-chip oscillator)
- 16-bit multiplication, 16-bit multiply-accumulation, and 32-bit division are supported.
- Address space: 1 MB
- General-purpose registers: (8-bit register  $\times$  8)  $\times$  4 banks
- On-chip RAM: 6 KB to 16 KB

#### Code flash memory

- Code flash memory: 64 KB to 256 KB
- Block size: 1 KB
- Prohibition of block erase and rewriting (security function)
- On-chip debug function
- Self-programming (with boot swap function/flash shield window function)

#### Data flash memory

- Data flash memory: 2 KB
- Back ground operation (BGO): Instructions can be executed from the program memory while rewriting the data flash memory
- Number of rewrites: 1,000,000 times (TYP.)
- Voltage of rewrites:  $V_{DD}$  = 1.9 to 5.5 V

#### PLL clock<sup>Note 2</sup>

- 32 MHz is selectable ( $\Delta\Sigma$  A/D converter is operable even when the PLL clock is selected as a CPU clock.)

#### High-speed on-chip oscillator

- Select from 1 to 24 MHz (TYP.). However when it is used as a clock for the  $\Delta\Sigma$  A/D converter, select from 24 MHz (TYP.), 12 MHz (TYP.), 6 MHz (TYP.), or 3 MHz (TYP.).
- High accuracy:  $\pm 1.0\%$  ( $V_{DD}$  = 1.9 to 5.5 V,  $T_A$  = -20 to +85°C)
- On-chip high-speed on-chip oscillator clock frequency correction function

#### Middle-speed on-chip oscillator

- Select from 4 MHz/2 MHz/1 MHz (However  $\Delta\Sigma$  A/D converter is disabled.)

#### Operating ambient temperature

- $T_A$  = -40 to +85°C

#### Power management and reset function

- On-chip power-on-reset (POR) circuit for Internal  $V_{DD}$ <sup>Note 3</sup> power supply
- On-chip RTC power-on-reset (RTCPOR) circuit for VRTC power supply
- On-chip voltage detector (LVD) (Select interrupt and reset from 13 levels)

#### Voltage detective circuit

- Detective voltage for  $V_{DD}$  pin (Select interrupt from 6 levels)
- Detective voltage for VBAT pin (Select interrupt from 7 levels)
- Detective voltage for VRTC pin (Select interrupt from 4 levels)
- Detective voltage for EXLVD pin (Select interrupt from 1 level)

## Data transfer controller (DTC)

- Transfer mode: Normal mode, repeat mode, block mode
- Activation source: Start by interrupt sources
- Chain transfer function

## Event link controller (ELC)

- Event signals of 22 types can be linked to the specified peripheral function.

## On-chip 32-bit multiplier and multiply-accumulator

- 32 bits × 32 bits = 64 bits (Unsigned or signed)
- 32 bits × 32 bits + 64 bits = 64 bits (Unsigned or signed)

## Serial interface

- Simplified SPI (CSI): 2 to 3 channels
- UART/UART (LIN-bus supported): 2 to 3 channels
- UART/IrDA: 1 channel
- Simplified I<sup>2</sup>C communication: 2 to 3 channels
- I<sup>2</sup>C communication: 1 channel

## Timer

- 16-bit timer: 8 channels
- 12-bit interval timer: 1 channel
- 8-bit interval timer: 4 channels
- Independent power supply RTC: 1 channel (calendar for 99 years, alarm function, and clock correction function)
- Watchdog timer: 1 channel
- Oscillation stop detection circuit: 1 channel

## LCD controller/driver

- Internal voltage boosting method, capacitor split method, and external resistance division method are switchable
- Segment signal output: 19 (15)<sup>Note 4</sup> to 42 (38)<sup>Note 4</sup>
- Common signal output: 4 (8)<sup>Note 4</sup>

## A/D converter

- 24-Bit  $\Delta\Sigma$  A/D converter: 3 or 4 channels
- 8/10-bit resolution A/D converter ( $V_{DD} = 1.9$  to 5.5 V): 4 or 6 channels
- Internal reference voltage (1.45 V) and temperature sensor

## I/O port

- I/O port: 35 to 68 (N-ch open drain I/O [6 V tolerance]: 3, N-ch open drain I/O [ $V_{DD}$  tolerance<sup>Note 5</sup>/ $EV_{DD}$  tolerance<sup>Note 6</sup>]: 10 to 16)
- Can be set to N-ch open drain, TTL input buffer, and on-chip pull-up resistor
- Different potential interface: Can connect to a 1.8/2.5/3 V device
- On-chip clock output/buzzer output controller
- On-chip key interrupt function

AES circuit<sup>Note 7</sup>

- Cipher modes of operation: GCM/ECB/CBC
- Encryption key length: 128/192/256 bits

## Others

- On-chip BCD (binary-coded decimal) correction circuit
- On-chip battery backup function

**Notes** 1. The minimum operating voltage of this product varies according to the VBATEN setting value.

When VBATEN = 0, the minimum operating voltage is 1.7 V.

When VBATEN = 1, the minimum operating voltage is 1.9 V.

As well, the minimum operating voltage of VRTC is 1.6 V.

2. R5F10NPJ, R5F10NMJ, R5F10NPG only.

3. Either  $V_{DD}$  or VBAT is selected by the battery backup function.

4. The values in parentheses are the number of signal outputs when 8 com is used.

5. 64 pin products only

6. 80 pin, 100 pin products only

7. Only available in R5F10N products.

**Remark** The functions mounted depend on the product. See **1.6 Outline of Functions**.

## O ROM, RAM capacities

Code Flash	Data Flash	RAM	AES Function	RL78/I1C		
				64 pins	80 pins	100 pins
256 KB	2 KB	16 KB <sup>Note 1</sup>	Mounted	-	R5F10NMJ	R5F10NPJ
128 KB	2 KB	8 KB <sup>Note 2</sup>	Mounted	R5F10NLG	R5F10NMG	R5F10NPG
			Not mounted	R5F11TLG	-	-
64 KB	2 KB	6 KB	Mounted	R5F10NLE	R5F10NME	-
			Not mounted	R5F11TLE	-	-

**Notes 1.** This is about 15 KB when the self-programming function is used. (For details, refer to **CHAPTER 3 in the RL78/I1C User's Manual.**)

**2.** This is about 7 KB when the self-programming function is used (excluding in the case of the R5F10NPG). (For details, refer to **CHAPTER 3 in the RL78/I1C User's Manual.**)

1.2 List of Part Numbers

Figure 1-1. Part Number, Memory Size, and Package of RL78/I1C

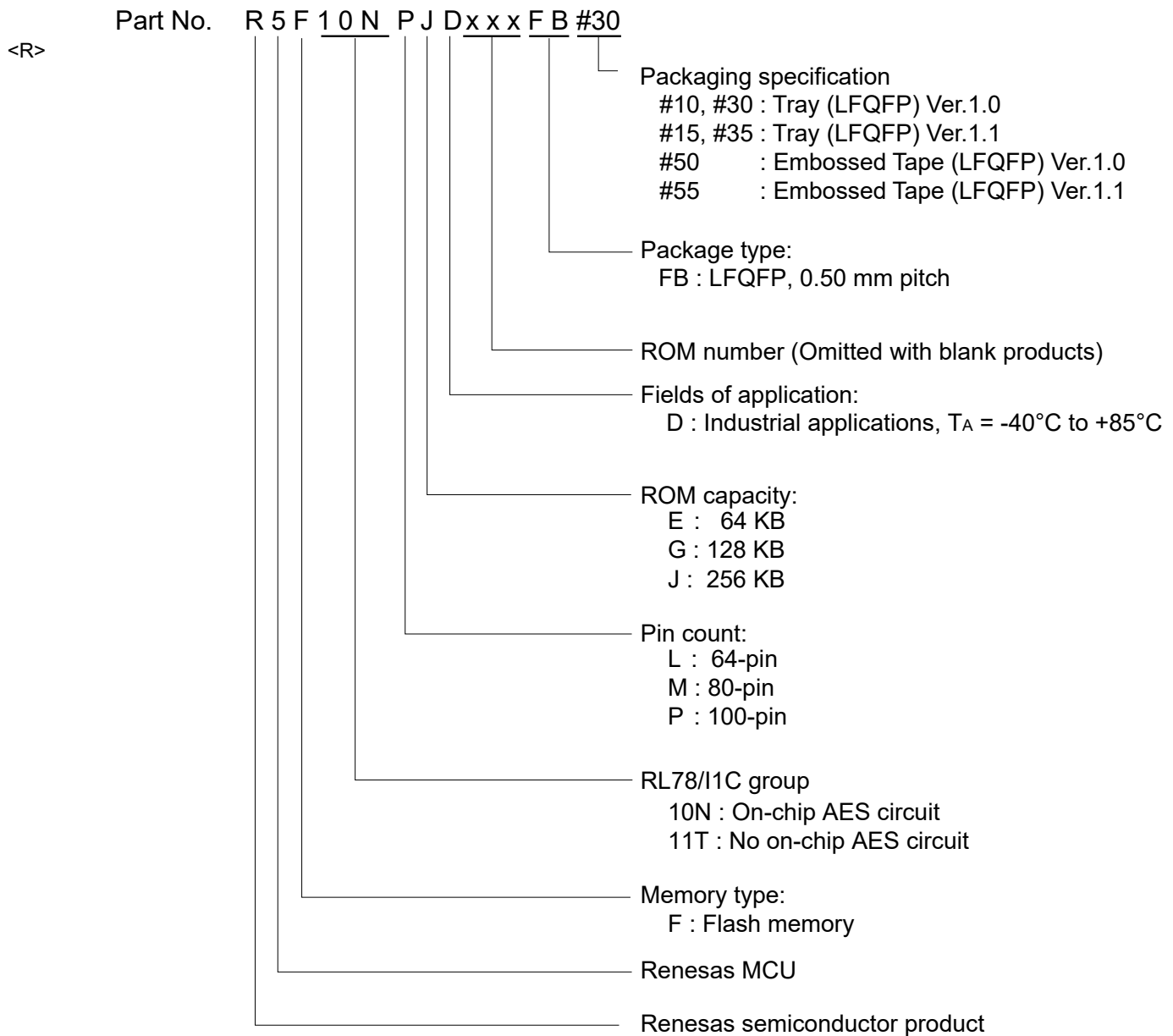

&lt;R&gt;

Table 1-1. List of Ordering Part Numbers

Pin Count	Package	Data Flash	AES Function	Fields of Application <sup>Note</sup>	Ordering Part Number
64 pins	64-pin plastic LFQFP (10 × 10 mm, 0.5 mm pitch)	Mounted	Mounted	D	R5F10NLEDFB#10, R5F10NLGDFB#10, R5F10NLEDFB#15, R5F10NLGDFB#15, R5F10NLEDFB#30, R5F10NLGDFB#30, R5F10NLEDFB#50, R5F10NLGDFB#50, R5F10NLEDFB#35, R5F10NLGDFB#35, R5F10NLEDFB#55, R5F10NLGDFB#55
			Not mounted	D	R5F11TLEDFB#10, R5F11TLGDFB#10, R5F11TLEDFB#15, R5F11TLGDFB#15, R5F11TLEDFB#30, R5F11TLGDFB#30, R5F11TLEDFB#50, R5F11TLGDFB#50, R5F11TLEDFB#35, R5F11TLGDFB#35, R5F11TLEDFB#55, R5F11TLGDFB#55
80 pins	80-pin plastic LFQFP (12 × 12 mm, 0.5 mm pitch)	Mounted	Mounted	D	R5F10NMEDFB#10, R5F10NMGDFB#10, R5F10NMJDFB#10, R5F10NMEDFB#15, R5F10NMGDFB#15, R5F10NMJDFB#15, R5F10NMEDFB#30, R5F10NMGDFB#30, R5F10NMJDFB#30, R5F10NMEDFB#35, R5F10NMGDFB#35, R5F10NMJDFB#35, R5F10NMEDFB#50, R5F10NMGDFB#50, R5F10NMJDFB#50, R5F10NMEDFB#55, R5F10NMGDFB#55, R5F10NMJDFB#55
100 pins	100-pin plastic LFQFP (14 × 14 mm, 0.5 mm pitch)	Mounted	Mounted	D	R5F10NPJDFB#10, R5F10NPGDFB#10, R5F10NPJDFB#15, R5F10NPGDFB#15, R5F10NPJDFB#30, R5F10NPGDFB#30, R5F10NPJDFB#35, R5F10NPGDFB#35, R5F10NPJDFB#50, R5F10NPGDFB#50, R5F10NPJDFB#55, R5F10NPGDFB#55

**Note** For the fields of application, see **Figure 1-1 Part Number, Memory Size, and Package of RL78/I1C**.

**Caution** The ordering part numbers represent the numbers at the time of publication. For the latest ordering part numbers, refer to the target product page of the Renesas Electronics website.

### 1.3 Pin Configuration (Top View)

#### 1.3.1 64-pin products

- 64-pin plastic LFQFP (10 × 10 mm, 0.5 mm pitch)

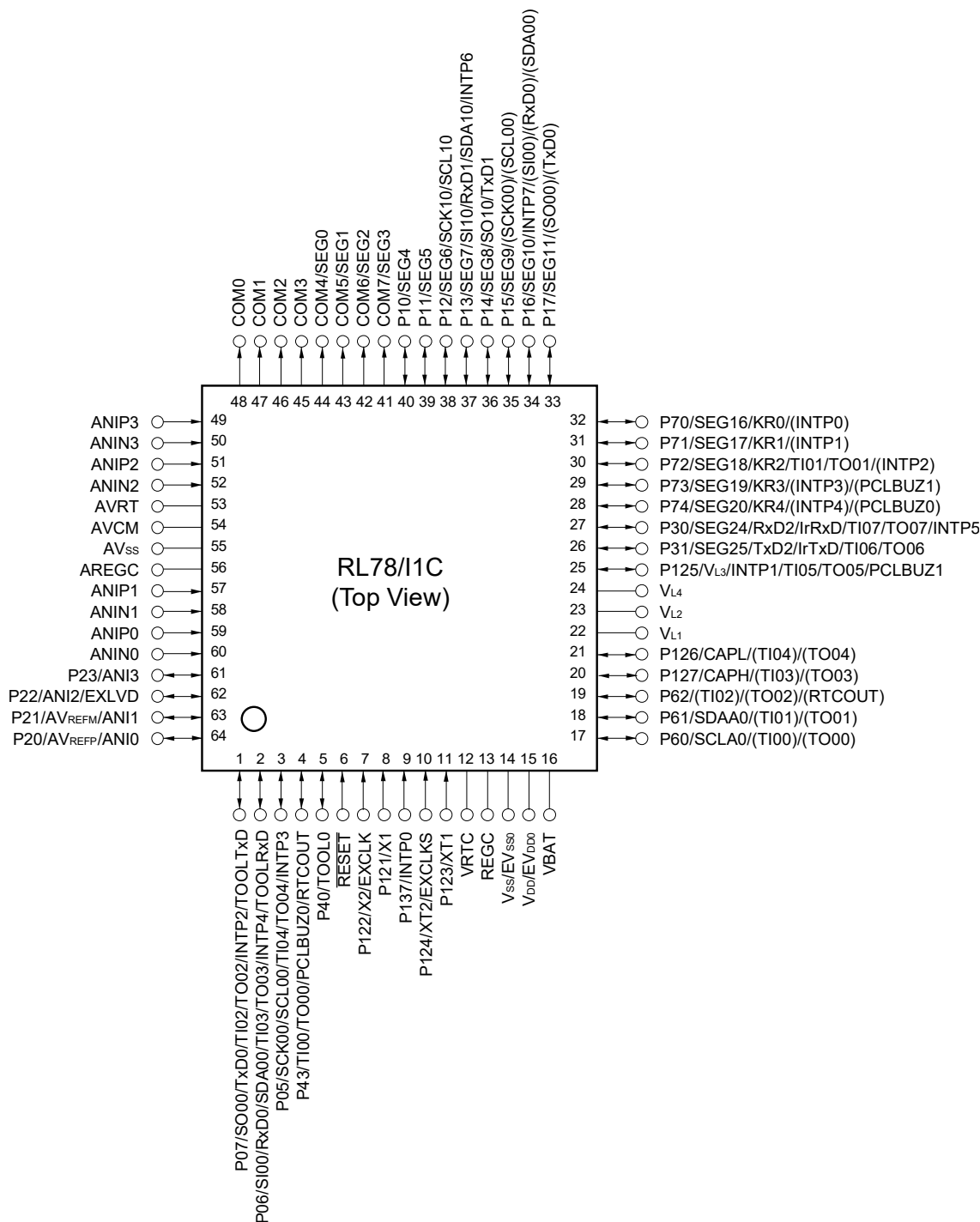

**Caution** Connect the REGC pin to V<sub>ss</sub> via a capacitor (0.47 to 1 μF).

**Remarks 1.** For pin identification, see 1.4 Pin Identification.

**2.** Functions in parentheses in the above figure can be assigned via settings in the peripheral I/O redirection register (PIOR0). See Figure 4-8 Format of Peripheral I/O Redirection Register (PIOR0) in the RL78/I1C User's Manual.

1.3.2 80-pin products

- 80-pin plastic LFQFP (12 × 12 mm, 0.5 mm pitch)

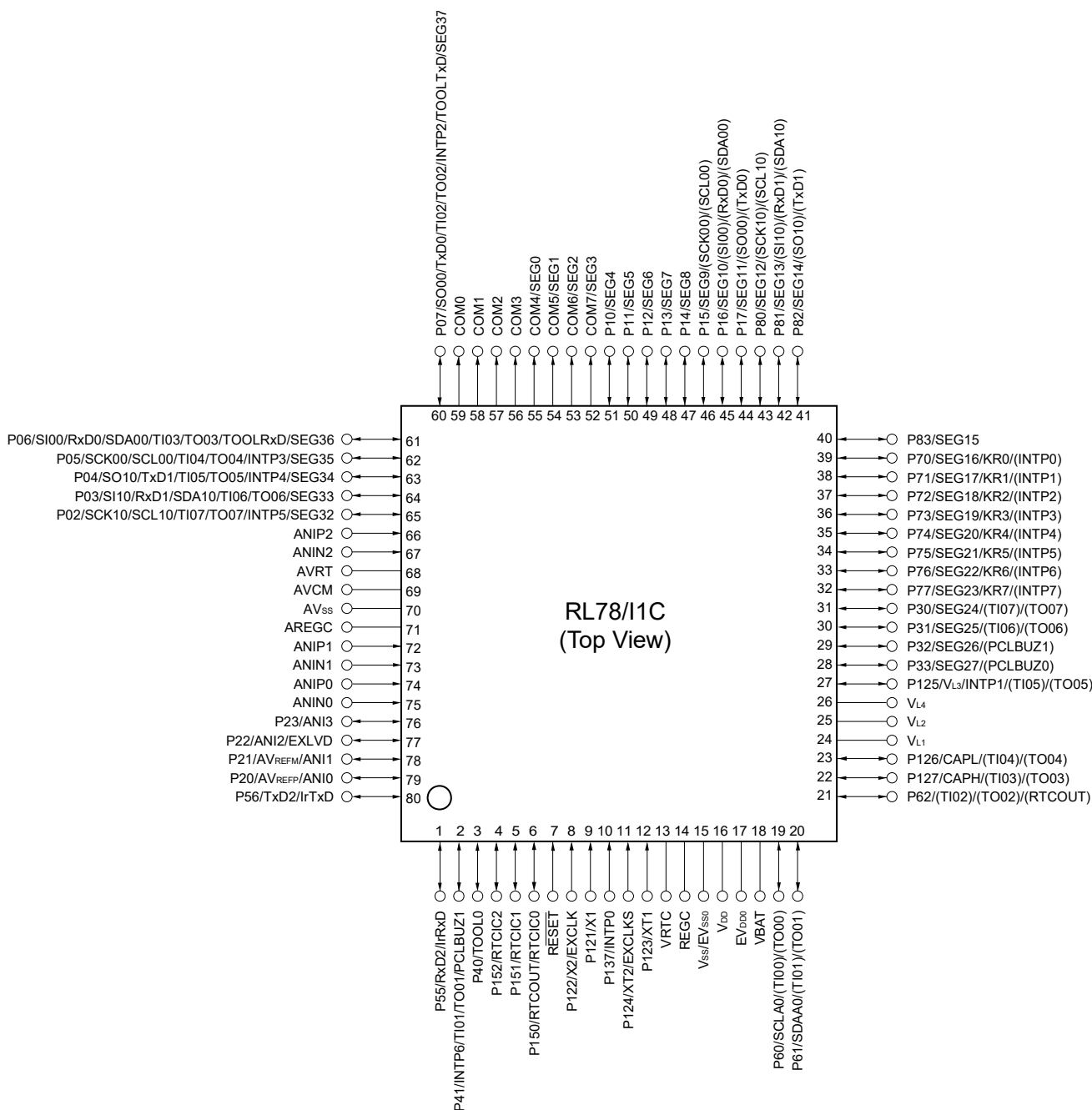

**Caution** Connect the REGC pin to V<sub>SS</sub> via a capacitor (0.47 to 1 μF).

- Remarks**
- For pin identification, see 1.4 Pin Identification.
  - Functions in parentheses in the above figure can be assigned via settings in the peripheral I/O redirection register (PIOR0). See Figure 4-8 Format of Peripheral I/O Redirection Register (PIOR0) in the RL78/I1C User's Manual.

1.3.3 100-pin products

- 100-pin plastic LQFP (14 × 14 mm, 0.5 mm pitch)

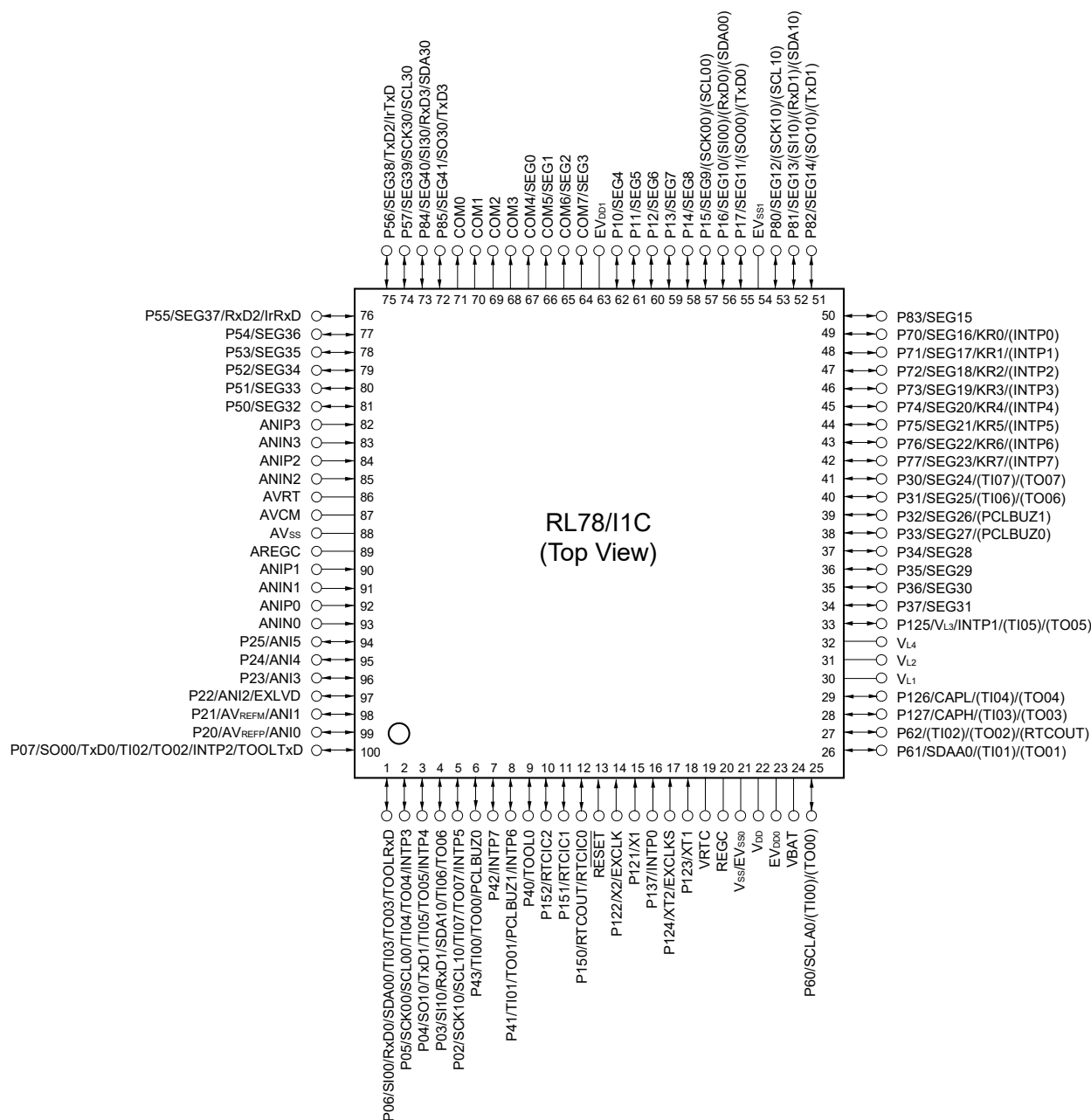

- Cautions**
1. Make EV<sub>SS1</sub> the same potential as V<sub>SS</sub>/EV<sub>SS0</sub>.
  2. Make EV<sub>DD1</sub> the same potential as EV<sub>DD0</sub>.
  3. Connect the REGC pin to V<sub>SS</sub> via a capacitor (0.47 to 1 μF).

- Remarks**
1. For pin identification, see 1.4 Pin Identification.
  2. When using the microcontroller for an application where the noise generated inside the microcontroller must be reduced, it is recommended to supply separate powers to the V<sub>DD</sub> and EV<sub>DD1</sub> pins and connect the V<sub>SS</sub> and EV<sub>SS1</sub> pins to separate ground lines.
  3. Functions in parentheses in the above figure can be assigned via settings in the peripheral I/O redirection register (PIOR0). See Figure 4-8 Format of Peripheral I/O Redirection Register (PIOR0) in the RL78/I1C User's Manual.



## 1.4 Pin Identification

ANI0 to ANI5:	Analog Input	P137:	Port 13
ANIN0 to ANIN3, ANIP0 to ANIP3:	Analog Input for $\Delta\Sigma$ ADC	P150 to P152:	Port 15
AREGC:	Regulator Capacitance for $\Delta\Sigma$ ADC	PCLBUZ0, PCLBUZ1:	Programmable Clock Output/Buzzer Output
AVCM:	Control for $\Delta\Sigma$ ADC	REGC:	Regulator Capacitance
AVREFM:	A/D Converter Reference Potential (– side) Input	RESET:	Reset
AVREFP:	A/D Converter Reference Potential (+ side) Input	RTCOUT:	Real-time Clock Correction Clock (1 Hz/64 Hz) Output
AVRT:	Reference Potential for $\Delta\Sigma$ ADC	RTCIC0 to RTCIC2:	RTC Time Capture Event Input
AVss:	Ground for $\Delta\Sigma$ ADC	RxD0 to RxD3:	Receive Data for UART
CAPH, CAPL:	Capacitor Connection for LCD Controller/Driver	SCL00, SCL10, SCL30:	Serial Clock Output for Simplified IIC
COM0 to COM7:	Common Signal Output for LCD Controller/Driver	SDA00, SDA10, SDA30:	Serial Data Input/Output for Simplified IIC
EVDD0, EVDD1:	Power Supply for Port	SCLA0 :	Serial Clock Input/Output for IICA0
EVSS0, EVSS1:	Ground for Port	SDAA0:	Serial Data Input/Output for IICA0
EXCLK:	External Clock Input (Main System Clock)	SCK00, SCK10, SCK30:	Serial Clock Input/Output for CSI
EXCLKS:	External Clock Input (Subsystem clock)	SEG0 to SEG41:	Segment Signal Output for LCD Controller/Driver
EXLVD:	External Input for Low Voltage Detector	SI00, SI10, SI30:	Serial Data Input for CSI
INTP0 to INTP7:	Interrupt Request From Peripheral	SO00, SO10, SO30:	Serial Data Output for CSI
IrRxD:	Receive Data for IrDA	TI00 to TI07:	Timer Input
IrTxD:	Transmit Data for IrDA	TO00 to TO07:	Timer Output
KR0 to KR7:	Key Return	TOOL0:	Data Input/Output for Tool
P02 to P07:	Port 0	TOOLRxD, TOOLTxD:	Data Input/Output for External Device
P10 to P17:	Port 1	TxD0 to TxD3:	Transmit Data for UART
P20 to P25:	Port 2	VBAT:	Battery Backup Power Supply
P30 to P37:	Port 3	VDD:	Power Supply
P40 to P43:	Port 4	VL1 to VL4:	Voltage for Driving LCD
P50 to P57:	Port 5	VRTC:	RTC Power Supply
P60 to P62:	Port 6	Vss:	Ground
P70 to P77:	Port 7	X1, X2:	Crystal Oscillator (Main System Clock)
P80 to P85:	Port 8	XT1, XT2:	Crystal Oscillator (Subsystem Clock)
P121 to P127:	Port 12		

### 1.5 Block Diagram

#### 1.5.1 64-pin products

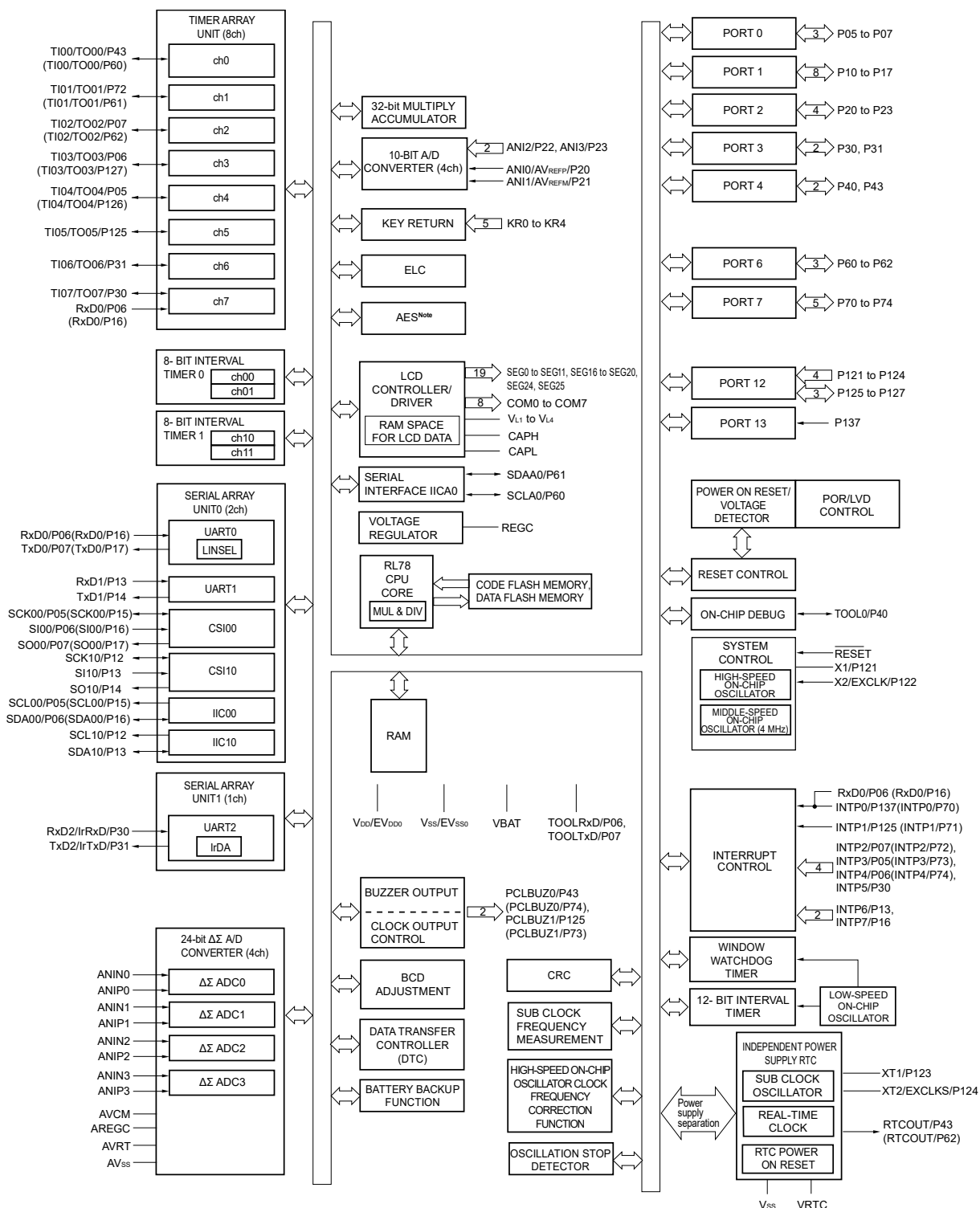

**Note** Only available in R5F10N products.

**Remark** Functions in parentheses in the above figure can be assigned via settings in the peripheral I/O redirection register (PIOR0). See **Figure 4-8 Format of Peripheral I/O Redirection Register (PIOR0) in the RL78/I1C User's Manual.**

1.5.2 80-pin products

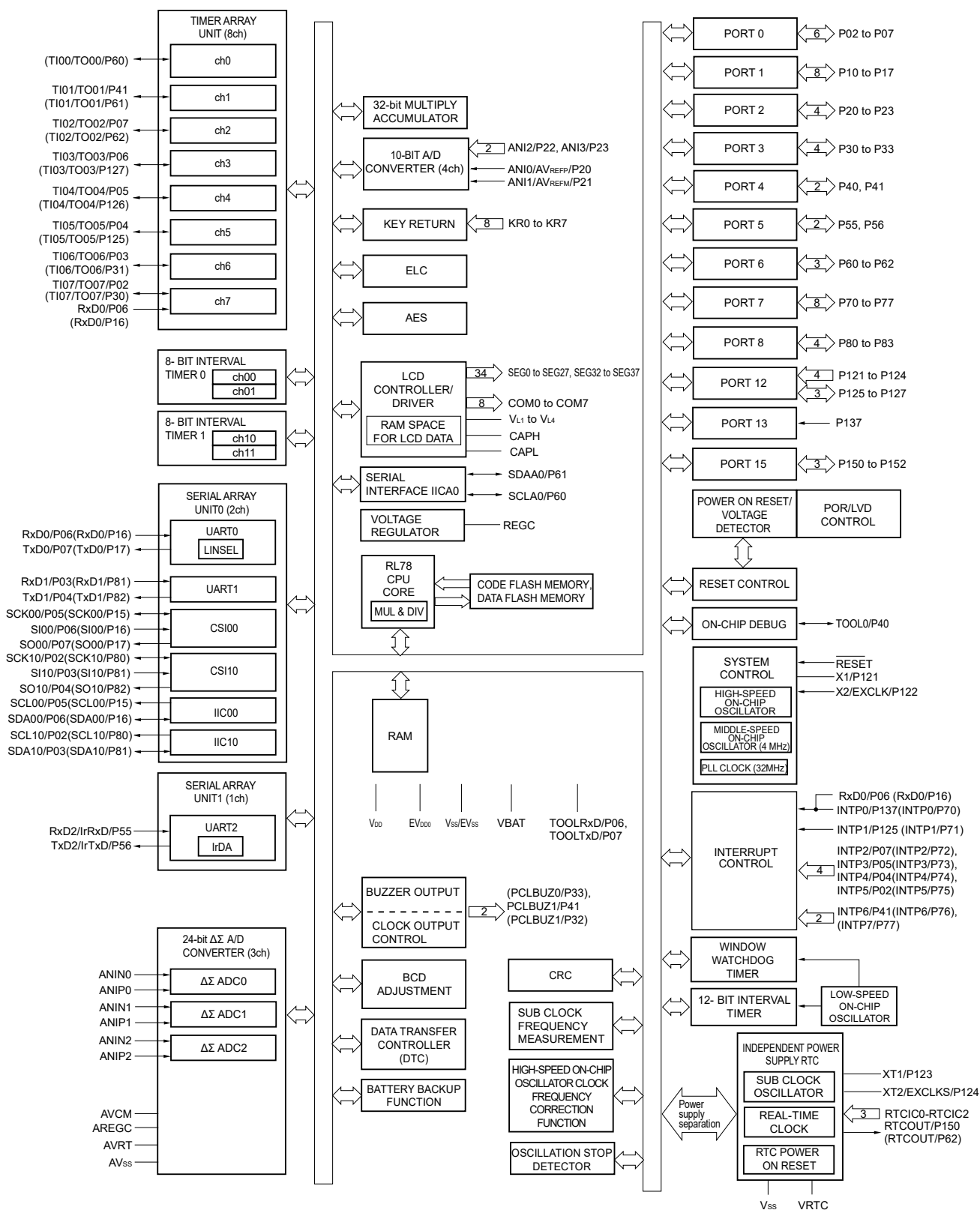

**Remark** Functions in parentheses in the above figure can be assigned via settings in the peripheral I/O redirection register (PIOR0). See **Figure 4-8 Format of Peripheral I/O Redirection Register (PIOR0)** in the **RL78/I1C User's Manual**.

1.5.3 100-pin products

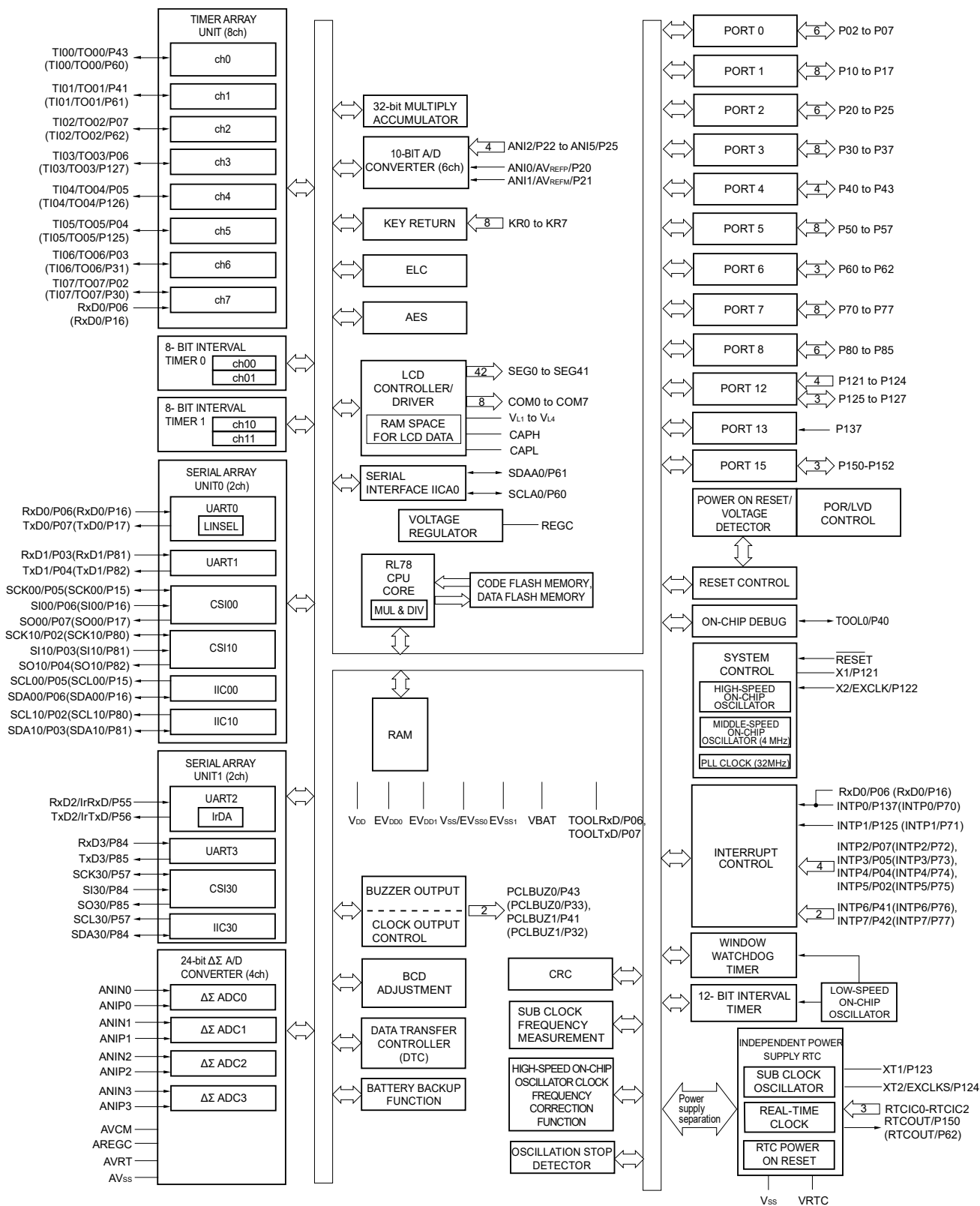

**Remark** Functions in parentheses in the above figure can be assigned via settings in the peripheral I/O redirection register (PIOR0). See **Figure 4-8 Format of Peripheral I/O Redirection Register (PIOR0) in the RL78/I1C User's Manual.**

## 1.6 Outline of Functions

(1/3)

Item		64-pin		80-pin			100-pin	
		R5F10NLEDFB/ R5F11TLEDFB	R5F10NLGDFB/ R5F11TLGDFB	R5F10NMEDFB	R5F10NMGDFB	R5F10NMJDFB	R5F10NPGDFB	R5F10NPJDFB
Code flash memory (KB)		64 KB	128 KB	64 KB	128 KB	256 KB	128 KB	256 KB
Data flash memory (KB)		2 KB						
RAM (KB)		6 KB	8 KB <sup>Note 1</sup>	6 KB	8 KB <sup>Note 1</sup>	16 KB <sup>Note 2</sup>	8 KB	16 KB <sup>Note 2</sup>
Address space		1 MB						
Main system clock	High-speed system clock	X1 (crystal/ceramic) oscillation, external main system clock input (EXCLK) HS (High-speed main) mode: 1 to 20 MHz ( $V_{DD} = 2.7$ to 5.5 V), HS (High-speed main) mode: 1 to 16 MHz ( $V_{DD} = 2.5$ to 5.5 V), HS (High-speed main) mode: 1 to 12 MHz ( $V_{DD} = 2.4$ to 5.5 V), HS (High-speed main) mode: 1 to 6 MHz ( $V_{DD} = 2.1$ to 5.5 V), LS (Low-speed main) mode: 1 to 8 MHz ( $V_{DD} = 1.9$ to 5.5 V), LV (Low-voltage main) mode: 1 to 4 MHz ( $V_{DD} = 1.7$ to 5.5 V), LP (Low-power main) mode: 1 MHz ( $V_{DD} = 1.9$ to 5.5 V)						
	High-speed on-chip oscillator clock ( $f_{IH}$ ) MAX.: 24 MHz	HS (High-speed main) mode: 1 to 24 MHz ( $V_{DD} = 2.7$ to 5.5 V), HS (High-speed main) mode: 1 to 16 MHz ( $V_{DD} = 2.5$ to 5.5 V), HS (High-speed main) mode: 1 to 12 MHz ( $V_{DD} = 2.4$ to 5.5 V), HS (High-speed main) mode: 1 to 6 MHz ( $V_{DD} = 2.1$ to 5.5 V), LS (Low-speed main) mode: 1 to 8 MHz ( $V_{DD} = 1.9$ to 5.5 V), LV (Low-voltage main) mode: 1 to 4 MHz ( $V_{DD} = 1.7$ to 5.5 V), LP (Low-power main) mode: 1 MHz ( $V_{DD} = 1.9$ to 5.5 V)						
	Middle-speed on-chip oscillator clock ( $f_{IM}$ ) MAX.: 4 MHz	LS (Low-speed main) mode: 1 to 8 MHz ( $V_{DD} = 1.9$ to 5.5 V), LV (Low-voltage main) mode: 1 to 4 MHz ( $V_{DD} = 1.7$ to 5.5 V), LP (Low-power main) mode: 1 MHz ( $V_{DD} = 1.9$ to 5.5 V)						
	PLL clock ( $f_{PLL}$ )	-					HS (High-speed main) mode: 32 MHz ( $V_{DD} = 2.8$ to 5.5 V)	
Subsystem clock	Subsystem clock oscillator clock ( $f_{SX}$ )	XT1 (crystal) oscillation, external subsystem clock input (EXCLKS) 32.768 kHz (TYP.): $V_{DD} = 1.7$ to 5.5 V						
	Low-speed on-chip oscillator clock ( $f_{IL}$ )	15 kHz (TYP.): $V_{DD} = 1.7$ to 5.5 V						
High-speed on-chip oscillator clock frequency correction function		Correct the frequency of the high-speed on-chip oscillator clock by the subsystem clock.						
General-purpose register		8 bits × 8 registers × 4 banks						
Minimum instruction execution time		0.03125 $\mu$ s (PLL clock: $f_{PLL} = 32$ MHz selection)						
		0.04167 $\mu$ s (High-speed on-chip oscillator: $f_{IH} = 24$ MHz operation)						
		30.5 $\mu$ s (Subsystem clock: $f_{SUB} = 32.768$ kHz operation)						
		66.6 $\mu$ s (Low-speed on-chip oscillator: $f_{IL} = 15$ kHz operation)						
Instruction set		<ul style="list-style-type: none"> <li>• Data transfer (8/16 bits)</li> <li>• Adder and subtractor/logical operation (8/16 bits)</li> <li>• Multiplication (16 bits × 16 bits), division (32 bits ÷ 32 bits)</li> <li>• Multiplication and accumulation (16 bits × 16 bits + 32 bits)</li> <li>• Rotate, barrel shift, and bit manipulation (set, reset, test, and boolean operation), etc.</li> </ul>						
I/O port	Total	35		52			68	
	CMOS I/O	27		44			60	
	CMOS input	5		5			5	
	CMOS output	-		-			-	
	N-ch O.D I/O (6 V tolerance)	3		3			3	

**Notes** 1. In the case of the 8 KB, this is about 7 KB when the self-programming function is used.

2. In the case of the 16 KB, this is about 15 KB when the self-programming function is used.

(2/3)

Item		64-pin		80-pin			100-pin	
		R5F10NLEDFB/ R5F11TLEDFB	R5F10NLGDFB/ R5F11TLGDFB	R5F10NMEDFB	R5F10NMGDFB	R5F10NMJDFB	R5F10NPGDFB	R5F10NPJDFB
Timer	16-bit timer TAU	8 channels						
	Watchdog timer	1 channel						
	12-bit interval timer	1 channel						
	8/16-bit interval timer	4 channels (8-bit)/2 channels (16-bit)						
	Independent power supply real-time clock (RTC)	1 channel						
	Oscillation stop detection circuit	1 channel						
	Timer output	Timer outputs: 8 channels PWM outputs: 7 <sup>Note 1</sup>						
	RTC output	1 channel • 1 Hz/64 Hz (sub clock: $f_{sx} = 32.768$ kHz)						
	RTC time capture input	-	3 channels					
Clock output/buzzer output		2 • 2.44 kHz, 4.88 kHz, 9.76 kHz, 1.25 MHz, 2.5 MHz, 5 MHz, 10 MHz (Main system clock: $f_{MAIN} = 20$ MHz operation) • 256 Hz, 512 Hz, 1.024 kHz, 2.048 kHz, 4.096 kHz, 8.192 kHz, 16.384 kHz, 32.768 kHz (Sub clock: $f_{sx} = 32.768$ kHz operation)						
10-bit resolution A/D converter		4 channels		4 channels			6 channels	
24-Bit $\Delta\Sigma$ A/D Converter		4 channels		3 channels			4 channels	
	SNDR	Typ. 80 dB (gain $\times 1$ ) Min. 69 dB (gain $\times 16$ ) Min. 65 dB (gain $\times 32$ )						
	Sampling frequency	3.906 kHz/1.953 kHz						
	PGA	$\times 1, \times 2, \times 4, \times 8, \times 16, \times 32$						
Serial interface	Simplified SPI (CSI)/ UART/simplified I <sup>2</sup> C:	2 channels		2 channels			3 channels	
	UART/IrDA	1 channel						
	I <sup>2</sup> C bus	1 channel						
32-bit multiplier and multiply-accumulator		32 bits $\times$ 32 bits = 64 bits (Unsigned or signed) (5 clock) 32 bits $\times$ 32 bits + 64 bits = 64 bits (Unsigned or signed) (5 clock)						
Data transfer controller (DTC)		36 sources					38 sources	
Event link controller (ELC)	Event input	9						
	Event trigger input	13						
LCD controller/driver		Internal voltage boosting method, capacitor split method, and external resistance division method are switchable.						
	Segment signal output	19 (15) <sup>Note 2</sup>		34 (30) <sup>Note 2</sup>			42 (38) <sup>Note 2</sup>	
	Common signal output	4 (8) <sup>Note 2</sup>						
Vectored interrupt sources	Internal	41		41			44	
	External	9		12			12	

**Notes 1.** The number of outputs varies, depending on the setting of channels in use and the number of the master (see **8.9.3 Operation as multiple PWM output function in the RL78/I1C User's Manual**).

**2.** The values in parentheses are the number of signal outputs when 8 com is used.

(3/3)

Item	64-pin		80-pin			100-pin	
	R5F10NLEDFB/ R5F11TLEDFB	R5F10NLGDFB/ R5F11TLGDFB	R5F10NMEDFB	R5F10NMGDFB	R5F10NMJDFB	R5F10NPGDFB	R5F10NPJDFB
Key interrupt input	5		8				
AES circuit <sup>Note 3</sup>	Cipher modes of operation: GCM/ECB/CBC Encryption key length: 128/192/256-bit						
Reset	MCU	<ul style="list-style-type: none"> <li>Reset by <math>\overline{\text{RESET}}</math> pin</li> <li>Internal reset by watchdog timer</li> <li>Internal reset by power-on-reset of internal <math>V_{DD}</math><sup>Note 1</sup> power supply</li> <li>Internal reset by voltage detector of internal <math>V_{DD}</math><sup>Note 1</sup> power supply</li> <li>Internal reset by illegal instruction execution<sup>Note 2</sup></li> <li>Internal reset by RAM parity error</li> <li>Internal reset by illegal-memory access</li> </ul>					
	RTC	<ul style="list-style-type: none"> <li>RTC circuit reset by RTC Power-on-reset</li> </ul>					
Power-on-reset circuit	Internal $V_{DD}$ <sup>Note 1</sup>	<ul style="list-style-type: none"> <li>Power-on-reset: 1.51 V (TYP.)</li> <li>Power-down-reset: 1.50 V (TYP.)</li> </ul>					
	VRTC	<ul style="list-style-type: none"> <li>RTC Power-on-reset: 1.52 V (TYP.)</li> <li>RTC Power-down-reset: 1.50 V (TYP.)</li> </ul>					
Voltage detector	Internal $V_{DD}$ <sup>Note 1</sup>	<ul style="list-style-type: none"> <li>Rising edge: 1.77 V to 4.06 V (13 stages)</li> <li>Falling edge: 1.73 V to 3.98 V (13 stages)</li> </ul>					
	$V_{DD}$	<ul style="list-style-type: none"> <li>Rising edge: 2.53 V to 3.77 V (6 stages)</li> <li>Falling edge: 2.46 V to 3.70 V (6 stages)</li> </ul>					
	VBAT	<ul style="list-style-type: none"> <li>Rising edge: 2.11 V to 2.73 V (7 stages)</li> <li>Falling edge: 2.05 V to 2.67 V (7 stages)</li> </ul>					
	VRTC	<ul style="list-style-type: none"> <li>Rising edge: 2.22 V to 2.84 V (4 stages)</li> <li>Falling edge: 2.16 V to 2.78 V (4 stages)</li> </ul>					
	EXLVD	<ul style="list-style-type: none"> <li>Rising edge: 1.33 V</li> <li>Falling edge: 1.28 V</li> </ul>					
Battery backup function	CPU	$V_{DD}$ /VBAT					
	$\Delta\Sigma$ A/D Converter	$V_{DD}$ /VBAT					
	RTC	VRTC (independent power supply)					
On-chip debug function	Provided						
Power supply voltage	$V_{DD} = 1.7$ to 5.5 V						
Operating ambient temperature	$T_A = -40$ to +85°C						

- Notes**
1. Either  $V_{DD}$  or VBAT is selected by the battery backup function.
  2. This reset occurs when instruction code FFH is executed.  
This reset does not occur during emulation using an in-circuit emulator or an on-chip debugging emulator.
  3. Only available in R5F10N products.

## 2. ELECTRICAL SPECIFICATIONS

- Cautions**
1. The RL78 microcontrollers have an on-chip debug function, which is provided for development and evaluation. Do not use the on-chip debug function in products designated for mass production, because the guaranteed number of rewritable times of the flash memory may be exceeded when this function is used, and product reliability therefore cannot be guaranteed. Renesas Electronics is not liable for problems occurring when the on-chip debug function is used.
  2. The pins mounted depend on the product. See 2.1 Port Function to 2.2.1 With functions for each product in the RL78/I1C User's Manual.

- Remarks**
1. In the descriptions in this chapter, read  $EV_{DD}$  as  $EV_{DD0}$  and  $EV_{DD1}$ , and  $EV_{SS}$  as  $EV_{SS0}$  and  $EV_{SS1}$ .
  2. For 64-pin products, read  $EV_{DD}$  as  $V_{DD}$  and  $EV_{SS}$  as  $V_{SS}$ .



## 2.1 Absolute Maximum Ratings

### Absolute Maximum Ratings (1/3)

Parameter	Symbols	Conditions	Ratings	Unit
Supply voltage	V <sub>DD</sub>		-0.5 to +6.5	V
	EV <sub>DD</sub>		-0.5 to +6.5	V
	V <sub>BAT</sub>		-0.5 to +6.5	V
	V <sub>RTC</sub>		-0.5 to +6.5	V
REGC pin input voltage	V <sub>IREGC</sub>	REGC	-0.3 to +2.8 and -0.3 to V <sub>DD</sub> <sup>Note 4</sup> +0.3 <sup>Note 1</sup>	V
Input voltage	V <sub>I1</sub>	P02 to P07, P10 to P17, P30 to P37, P40 to P43, P50 to P57, P70 to P77, P80 to P85, P125 to P127	-0.3 to EV <sub>DD</sub> +0.3 and -0.3 to V <sub>DD</sub> <sup>Note 4</sup> +0.3 <sup>Note 2</sup>	V
	V <sub>I2</sub>	P60 to P62 (N-ch open-drain)	-0.3 to +6.5	V
	V <sub>I3</sub>	P20 to P25, P121 to P122, P137, P150 to 152, EXCLK	-0.3 to V <sub>DD</sub> <sup>Note 4</sup> +0.3 <sup>Note 2</sup>	V
	V <sub>I4</sub>	RESET	-0.3 to +6.5	V
	V <sub>I5</sub>	P123, P124, EXCLKS	-0.3 to V <sub>RTC</sub> +0.3 <sup>Note 2</sup>	V
Output voltage	V <sub>O1</sub>	P02 to P07, P10 to P17, P30 to P37, P40 to P43, P50 to P57, P60 to P62, P70 to P77, P80 to P85, P125 to P127	-0.3 to EV <sub>DD</sub> +0.3 and -0.3 to V <sub>DD</sub> <sup>Note 4</sup> +0.3 <sup>Note 2</sup>	V
	V <sub>O2</sub>	P20 to P25, P150 to P152	-0.3 to V <sub>DD</sub> <sup>Note 4</sup> +0.3 <sup>Note 2</sup>	V
Analog input voltage	V <sub>AI1</sub>	ANI0 to ANI5	-0.3 to V <sub>DD</sub> <sup>Note 4</sup> +0.3 and -0.3 to AV <sub>REF(+)</sub> +0.3 <sup>Notes 2, 3</sup>	V
	V <sub>AI2</sub>	ANIP0 to ANIP3, ANIN0 to ANIN3	-0.6 to +2.8 and -0.6 to AREGC +0.3 <sup>Note 5</sup>	V
Reference supply voltage	V <sub>IDSAD</sub>	AREGC, AVCM, AVRT	-0.3 to +2.8 and -0.3 to V <sub>DD</sub> <sup>Note 4</sup> +0.3 <sup>Note 6</sup>	V

**Notes 1.** Connect the REGC pin to V<sub>SS</sub> via a capacitor (0.47 to 1 μF). This value regulates the absolute maximum rating of the REGC pin. Do not use this pin with voltage applied to it.

2. Must be 6.5 V or lower.
3. Do not exceed AV<sub>REF(+)</sub> + 0.3 V in case of A/D conversion target pin.
4. Either V<sub>DD</sub> or V<sub>BAT</sub> is selected by the battery backup function.
5. The ΔΣ A/D conversion target pin must not exceed AREGC +0.3 V.
6. Connect AREGC, AVCM, and AVRT terminals to V<sub>SS</sub> via capacitor (0.47 μF).

This value defines the absolute maximum rating of AREGC, AVCM, and AVRT terminal. Do not use with voltage applied.

**Caution** Product quality may suffer if the absolute maximum rating is exceeded even momentarily for any parameter. That is, the absolute maximum ratings are rated values at which the product is on the verge of suffering physical damage, and therefore the product must be used under conditions that ensure that the absolute maximum ratings are not exceeded.

**Remarks 1.** Unless specified otherwise, the characteristics of alternate-function pins are the same as those of the port pins.

2. AV<sub>REF(+)</sub>: + side reference voltage of the A/D converter.
3. V<sub>SS</sub>: Reference voltage

**Absolute Maximum Ratings (2/3)**

Parameter	Symbols	Conditions	Ratings	Unit
LCD voltage	V <sub>LI1</sub>	V <sub>L1</sub> voltage <sup>Note 1</sup>	-0.3 to 2.8 and -0.3 to V <sub>L4</sub> +0.3	V
	V <sub>LI2</sub>	V <sub>L2</sub> voltage <sup>Note 1</sup>	-0.3 to V <sub>L4</sub> +0.3 <sup>Note 2</sup>	V
	V <sub>LI3</sub>	V <sub>L3</sub> voltage <sup>Note 1</sup>	-0.3 to V <sub>L4</sub> +0.3 <sup>Note 2</sup>	V
	V <sub>LI4</sub>	V <sub>L4</sub> voltage <sup>Note 1</sup>	-0.3 to +6.5	V
	V <sub>LCAP</sub>	CAPL, CAPH voltage <sup>Note 1</sup>	-0.3 to V <sub>L4</sub> +0.3 <sup>Note 2</sup>	V
	V <sub>OUT</sub>	COM0 to COM7, SEG0 to SEG41, output voltage	External resistance division method Capacitor split method Internal voltage boosting method	-0.3 to V <sub>DD</sub> <sup>Note 3</sup> +0.3 <sup>Note 2</sup> -0.3 to V <sub>DD</sub> <sup>Note 3</sup> +0.3 <sup>Note 2</sup> -0.3 to V <sub>L4</sub> +0.3 <sup>Note 2</sup>

- Notes**
- This value only indicates the absolute maximum ratings when applying voltage to the V<sub>L1</sub>, V<sub>L2</sub>, V<sub>L3</sub>, and V<sub>L4</sub> pins; it does not mean that applying voltage to these pins is recommended. When using the internal voltage boosting method or capacitance split method, connect these pins to V<sub>SS</sub> via a capacitor (0.47 μF ± 30%) and connect a capacitor (0.47 μF ± 30%) between the CAPL and CAPH pins.
  - Must be 6.5 V or lower.
  - Either V<sub>DD</sub> or V<sub>BAT</sub> is selected by the battery backup function.

**Caution** Product quality may suffer if the absolute maximum rating is exceeded even momentarily for any parameter. That is, the absolute maximum ratings are rated values at which the product is on the verge of suffering physical damage, and therefore the product must be used under conditions that ensure that the absolute maximum ratings are not exceeded.

**Remark** V<sub>SS</sub>: Reference voltage

**Absolute Maximum Ratings (3/3)**

Parameter	Symbols	Conditions		Ratings	Unit
Output current, high	I <sub>OH1</sub>	Per pin	P02 to P07, P10 to P17, P30 to P37, P40 to P43, P50 to P57, P70 to P77, P80 to P85, P125 to P127	-40	mA
		Total of all pins -170 mA	P02 to P07, P40 to P43	-70	mA
			P10 to P17, P30 to P37, P50 to P57, P70 to P77, P80 to P85, P125 to P127	-100	mA
	I <sub>OH2</sub>	Per pin	P20 to P25, P150 to P152	-0.5	mA
		Total of all pins		-2	mA
Output current, low	I <sub>OL1</sub>	Per pin	P02 to P07, P10 to P17, P30 to P37, P40 to P43, P50 to P57, P70 to P77, P80 to P85, P125 to P127	40	mA
		Total of all pins 170 mA	P02 to P07, P40 to P43	70	mA
			P10 to P17, P30 to P37, P50 to P57, P60 to P62, P70 to P77, P80 to P85, P125 to P127	100	mA
	I <sub>OL2</sub>	Per pin	P20 to P25, P150 to P152	1	mA
		Total of all pins		5	mA
Operating ambient temperature	T <sub>A</sub>	In normal operation mode		-40 to +85	°C
		In flash memory programming mode			
Storage temperature	T <sub>stg</sub>			-65 to +150	°C

**Caution** Product quality may suffer if the absolute maximum rating is exceeded even momentarily for any parameter. That is, the absolute maximum ratings are rated values at which the product is on the verge of suffering physical damage, and therefore the product must be used under conditions that ensure that the absolute maximum ratings are not exceeded.

**Remark** Unless specified otherwise, the characteristics of alternate-function pins are the same as those of the port pins.

## 2.2 Oscillator Characteristics

### 2.2.1 X1, XT1 oscillator characteristics

( $T_A = -40$  to  $+85^\circ\text{C}$ ,  $1.7\text{ V} \leq V_{DD}^{\text{Note 2}} \leq 5.5\text{ V}$ ,  $V_{SS} = 0\text{ V}$ )

Parameter	Resonator	Conditions	MIN.	TYP.	MAX.	Unit
X1 clock oscillation frequency ( $f_x$ ) <sup>Notes 1, 2</sup>	Ceramic resonator/ crystal resonator	$2.7\text{ V} \leq V_{DD} \leq 5.5\text{ V}$	1.0		20.0	MHz
		$2.5\text{ V} \leq V_{DD} < 2.7\text{ V}$	1.0		16.0	MHz
		$2.4\text{ V} \leq V_{DD} < 2.5\text{ V}$	1.0		12.0	MHz
		$1.9\text{ V} \leq V_{DD} < 2.4\text{ V}$	1.0		8.0	MHz
		$1.7\text{ V} \leq V_{DD} < 1.9\text{ V}$	1.0		4.0	MHz
XT1 clock oscillation frequency ( $f_{XT}$ ) <sup>Notes 1, 2</sup>	Crystal resonator		32	32.768	35	kHz

- Notes**
1. Indicates only permissible oscillator frequency ranges. See **2.4 AC Characteristics** for instruction execution time. Request evaluation by the manufacturer of the oscillator circuit mounted on a board to check the oscillator characteristics.
  2. Either  $V_{DD}$  or  $V_{BAT}$  is selected by the battery backup function.

**Caution** Since the CPU is started by the high-speed on-chip oscillator clock after a reset release, check the X1 clock oscillation stabilization time using the oscillation stabilization time counter status register (OSTC) by the user. Determine the oscillation stabilization time of the OSTC register and the oscillation stabilization time select register (OSTS) after sufficiently evaluating the oscillation stabilization time with the resonator to be used.

**Remark** When using the X1 oscillator and XT1 oscillator, see **6.4 System Clock Oscillator in the RL78/I1C User's Manual**.

## 2.2.2 On-chip oscillator characteristics

(T<sub>A</sub> = -40 to +85°C, 1.7 V ≤ V<sub>DD</sub><sup>Note 3</sup> ≤ 5.5 V, V<sub>SS</sub> = 0 V)

Oscillators	Parameters	Conditions		MIN.	TYP.	MAX.	Unit
High-speed on-chip oscillator clock frequency <sup>Notes 1, 2</sup>	f <sub>H</sub>			1.5		24	MHz
High-speed on-chip oscillator clock frequency accuracy		-20 to +85°C	1.9 V ≤ V <sub>DD</sub> <sup>Note 3</sup> ≤ 5.5 V	-1.0		+1.0	%
			1.7 V ≤ V <sub>DD</sub> <sup>Note 3</sup> ≤ 1.9 V	-5.0		+5.0	%
		-40 to -20°C	1.9 V ≤ V <sub>DD</sub> <sup>Note 3</sup> ≤ 5.5 V	-1.5		+1.5	%
			1.7 V ≤ V <sub>DD</sub> <sup>Note 3</sup> ≤ 1.9 V	-5.5		+5.5	%
Middle-speed on-chip oscillator clock frequency <sup>Note 2</sup>	f <sub>M</sub>			1		4	MHz
Middle-speed on-chip oscillator clock frequency accuracy		1.9 V ≤ V <sub>DD</sub> <sup>Note 3</sup> ≤ 5.5 V		-12		+12	%
Low-speed on-chip oscillator clock frequency	f <sub>L</sub>				15		kHz
Low-speed on-chip oscillator clock frequency accuracy				-15		+15	%

- Notes 1.** The high-speed on-chip oscillator frequency is selected by using bits 0 to 3 of option byte (000C2H/010C2H) and bits 0 to 2 of the HOCODIV register.
- 2.** This indicates the oscillator characteristics only. See **2.4 AC Characteristics** for the instruction execution time.
- 3.** Either V<sub>DD</sub> or VBAT is selected by the battery backup function.

### 2.2.3 PLL oscillator characteristics

( $T_A = -40$  to  $+85^\circ\text{C}$ ,  $2.7\text{ V} \leq V_{DD}$ <sup>Note 2</sup>  $\leq 5.5\text{ V}$ ,  $V_{SS} = 0\text{ V}$ )

Oscillators	Parameters	Conditions	MIN.	TYP.	MAX.	Unit
PLL input frequency <sup>Note 1</sup>	$f_{\text{PLLIN}}$	$f_{\text{IH}}$		4		MHz
PLL output frequency <sup>Note 1</sup>	$f_{\text{PLL}}$			32		MHz
Lockup wait time		Wait time from PLL output enable to frequency stabilization	40			$\mu\text{s}$
Interval wait time		Wait time from PLL stop to PLL restart setting	4			$\mu\text{s}$
Setting wait time		Wait time from PLL input clock stabilization and PLL setting fixedness to start-up setting	1			$\mu\text{s}$

**Notes 1.** Indicates only permissible oscillator frequency ranges.

**2.** Either  $V_{DD}$  or  $V_{BAT}$  is selected by the battery backup function.

## 2.3 DC Characteristics

### 2.3.1 Pin characteristics

( $T_A = -40$  to  $+85^\circ\text{C}$ ,  $1.7\text{ V} \leq EV_{DD0} = EV_{DD1} \leq V_{DD}^{\text{Note 4}} \leq 5.5\text{ V}$ ,  $V_{SS} = EV_{SS0} = EV_{SS1} = 0\text{ V}$ )

Items	Symbol	Conditions	MIN.	TYP.	MAX.	Unit	
Output current, high <sup>Note 1</sup>	I <sub>OH1</sub>	Per pin for P02 to P07, P10 to P17, P30 to P37, P40 to P43, P50 to P57, P70 to P77, P80 to P85, P125 to P127	$1.9\text{ V} \leq EV_{DD} \leq 5.5\text{ V}$			-10.0 <sup>Note 2</sup>	mA
		Total of P02 to P07, P40 to P43 (When duty $\leq 70\%$ <sup>Note 3</sup> )	$4.0\text{ V} \leq EV_{DD} \leq 5.5\text{ V}$			-55.0	mA
			$2.7\text{ V} \leq EV_{DD} < 4.0\text{ V}$			-10.0	mA
			$1.9\text{ V} \leq EV_{DD} < 2.7\text{ V}$			-5.0	mA
			$1.7\text{ V} \leq EV_{DD} < 1.9\text{ V}$			-2.5	mA
		Total of P10 to P17, P30 to P37, P50 to P57, P70 to P77, P80 to P85, P125 to P127 (When duty $\leq 70\%$ <sup>Note 3</sup> )	$4.0\text{ V} \leq EV_{DD} \leq 5.5\text{ V}$			-80.0	mA
			$2.7\text{ V} \leq EV_{DD} < 4.0\text{ V}$			-19.0	mA
			$1.9\text{ V} \leq EV_{DD} < 2.7\text{ V}$			-10.0	mA
			$1.7\text{ V} \leq EV_{DD} < 1.9\text{ V}$			-5.0	mA
		Total of all pins (When duty $\leq 70\%$ <sup>Note 3</sup> )				-100.0	mA
	I <sub>OH2</sub>	Per pin for P20 to P25, P150 to P152	$1.7\text{ V} \leq V_{DD}^{\text{Note 4}} \leq 5.5\text{ V}$			-0.1 <sup>Note 2</sup>	mA
		Total of all pins (When duty $\leq 70\%$ <sup>Note 3</sup> )	$1.7\text{ V} \leq V_{DD}^{\text{Note 4}} \leq 5.5\text{ V}$			-0.9	mA

- Notes**
- Value of current at which the device operation is guaranteed even if the current flows from the EV<sub>DD</sub> and V<sub>DD</sub> pins to an output pin.
  - Do not exceed the total current value.
  - Specification under conditions where the duty factor  $\leq 70\%$ .  
The output current value that has changed to the duty factor  $> 70\%$  the duty ratio can be calculated with the following expression (when changing the duty factor from 70% to n%).
    - Total output current of pins =  $(I_{OH} \times 0.7)/(n \times 0.01)$   
 <Example> Where  $n = 80\%$  and  $I_{OH} = -10.0\text{ mA}$   
 Total output current of pins =  $(-10.0 \times 0.7)/(80 \times 0.01) \cong -8.7\text{ mA}$   
 However, the current that is allowed to flow into one pin does not vary depending on the duty factor.  
 A current higher than the absolute maximum rating must not flow into one pin.
  - Either V<sub>DD</sub> or V<sub>BAT</sub> is selected by the battery backup function.

**Caution** P02 to P07, P12 to P17, P31, P56, P57, P80 to P82, P84, and P85 do not output high level in N-ch open-drain mode.

**Remark** Unless specified otherwise, the characteristics of alternate-function pins are the same as those of the port pins.

( $T_A = -40$  to  $+85^\circ\text{C}$ ,  $1.7\text{ V} \leq EV_{DD0} = EV_{DD1} \leq V_{DD}^{\text{Note 4}} \leq 5.5\text{ V}$ ,  $V_{SS} = EV_{SS0} = EV_{SS1} = 0\text{ V}$ )

Items	Symbol	Conditions	MIN.	TYP.	MAX.	Unit	
Output current, $I_{OL}^{\text{Note 1}}$	$I_{OL1}$	Per pin for P02 to P07, P10 to P17, P30 to P37, P40 to P43, P50 to P57, P70 to P77, P80 to P85, P125 to P127			20.0 <sup>Note 2</sup>	mA	
		Per pin for P60 to P62			15.0 <sup>Note 2</sup>	mA	
		Total of P02 to P07, P40 to P43 (When duty $\leq 70\%$ <sup>Note 3</sup> )	$4.0\text{ V} \leq EV_{DD} \leq 5.5\text{ V}$			70.0	mA
			$2.7\text{ V} \leq EV_{DD} < 4.0\text{ V}$			15.0	mA
			$1.9\text{ V} \leq EV_{DD} < 2.7\text{ V}$			9.0	mA
			$1.7\text{ V} \leq EV_{DD} < 1.9\text{ V}$			4.5	mA
		Total of P10 to P17, P30 to P37, P50 to P57, P60 to P62, P70 to P77, P80 to P85, P125 to P127 (When duty $\leq 70\%$ <sup>Note 3</sup> )	$4.0\text{ V} \leq EV_{DD} \leq 5.5\text{ V}$			80.0	mA
			$2.7\text{ V} \leq EV_{DD} < 4.0\text{ V}$			35.0	mA
			$1.9\text{ V} \leq EV_{DD} < 2.7\text{ V}$			20.0	mA
			$1.7\text{ V} \leq EV_{DD} < 1.9\text{ V}$			10.0	mA
	Total of all pins (When duty $\leq 70\%$ <sup>Note 3</sup> )				150.0	mA	
	$I_{OL2}$	Per pin for P20 to P25, P150 to P152	$1.7\text{ V} \leq V_{DD}^{\text{Note 4}} \leq 5.5\text{ V}$			0.4 <sup>Note 2</sup>	mA
Total of all pins (When duty $\leq 70\%$ <sup>Note 3</sup> )		$1.7\text{ V} \leq V_{DD}^{\text{Note 4}} \leq 5.5\text{ V}$			3.6	mA	

- Notes**
- Value of current at which the device operation is guaranteed even if the current flows from an output pin to the  $EV_{SS}$  and  $V_{SS}$  pins.
  - However, do not exceed the total current value.
  - Specification under conditions where the duty factor  $\leq 70\%$ .  
The output current value that has changed to the duty factor  $> 70\%$  the duty ratio can be calculated with the following expression (when changing the duty factor from 70% to n%).
    - Total output current of pins =  $(I_{OL} \times 0.7)/(n \times 0.01)$
    - <Example> Where  $n = 80\%$  and  $I_{OL} = 10.0\text{ mA}$   
Total output current of pins =  $(10.0 \times 0.7)/(80 \times 0.01) \cong 8.7\text{ mA}$
 However, the current that is allowed to flow into one pin does not vary depending on the duty factor. A current higher than the absolute maximum rating must not flow into one pin.
  - Either  $V_{DD}$  or  $V_{BAT}$  is selected by the battery backup function.

**Remark** Unless specified otherwise, the characteristics of alternate-function pins are the same as those of the port pins.



( $T_A = -40$  to  $+85^\circ\text{C}$ ,  $1.7\text{ V} \leq EV_{DD0} = EV_{DD1} \leq V_{DD}^{\text{Note}} \leq 5.5\text{ V}$ ,  $V_{SS} = EV_{SS0} = EV_{SS1} = 0\text{ V}$ )

Items	Symbol	Conditions	MIN.	TYP.	MAX.	Unit	
Input voltage, high	$V_{IH1}$	P02 to P07, P10 to P17, P30 to P37, P40 to P43, P50 to P57, P70 to P77, P80 to P85, P125 to P127	Normal input buffer	$0.8EV_{DD}$		$EV_{DD}$	V
	$V_{IH2}$	P02, P03, P05, P06, P12, P13, P15, P16, P30, P55, P57, P80, P81, P84	TTL input buffer $4.0\text{ V} \leq EV_{DD} \leq 5.5\text{ V}$	2.2		$EV_{DD}$	V
			TTL input buffer $3.3\text{ V} \leq EV_{DD} < 4.0\text{ V}$	2.0		$EV_{DD}$	V
			TTL input buffer $1.7\text{ V} \leq EV_{DD} < 3.3\text{ V}$	1.5		$EV_{DD}$	V
	$V_{IH3}$	P20 to P25		$0.7V_{DD}^{\text{Note}}$		$V_{DD}^{\text{Note}}$	V
	$V_{IH4}$	P60 to P62		$0.7EV_{DD}$		6.0	V
	$V_{IH5}$	P121 to P122, P137, P150 to P152, EXCLK		$0.8V_{DD}^{\text{Note}}$		$V_{DD}^{\text{Note}}$	V
	$V_{IH6}$	RESET		$0.8V_{DD}^{\text{Note}}$		6.0	V
$V_{IH7}$	P123, P124, EXCLKS		$0.8V_{RTC}$		$V_{RTC}$	V	
Input voltage, low	$V_{IL1}$	P02 to P07, P10 to P17, P30 to P37, P40 to P43, P50 to P57, P70 to P77, P80 to P85, P125 to P127	Normal input buffer	0		$0.2EV_{DD}$	V
	$V_{IL2}$	P02, P03, P05, P06, P12, P13, P15, P16, P30, P55, P57, P80, P81, P84	TTL input buffer $4.0\text{ V} \leq EV_{DD} \leq 5.5\text{ V}$	0		0.8	V
			TTL input buffer $3.3\text{ V} \leq EV_{DD} < 4.0\text{ V}$	0		0.5	V
			TTL input buffer $1.7\text{ V} \leq EV_{DD} < 3.3\text{ V}$	0		0.32	V
	$V_{IL3}$	P20 to P25		0		$0.3V_{DD}^{\text{Note}}$	V
	$V_{IL4}$	P60 to P62		0		$0.3EV_{DD}$	V
	$V_{IL5}$	P121, P122, P137, P150 to P152, EXCLK, RESET		0		$0.2V_{DD}^{\text{Note}}$	V
	$V_{IL6}$	P123, P124, EXCLKS		0		$0.2V_{RTC}$	V

**Note** Either  $V_{DD}$  or  $V_{BAT}$  is selected by the battery backup function.

**Caution** The maximum value of  $V_{IH}$  of pins P02 to P07, P12 to P17, P31, P56, P57, P80 to P82, P84, and P85 is  $EV_{DD}$ , even in the N-ch open-drain mode.

**Remark** Unless specified otherwise, the characteristics of alternate-function pins are the same as those of the port pins.

( $T_A = -40$  to  $+85^\circ\text{C}$ ,  $1.7\text{ V} \leq EV_{DD0} = EV_{DD1} \leq V_{DD}^{\text{Note}} \leq 5.5\text{ V}$ ,  $V_{SS} = EV_{SS0} = EV_{SS1} = 0\text{ V}$ )

Items	Symbol	Conditions	MIN.	TYP.	MAX.	Unit	
Output voltage, high	$V_{OH1}$	P02 to P07, P10 to P17, P30 to P37, P40 to P43, P50 to P57, P70 to P77, P80 to P85, P125 to P127	$4.0\text{ V} \leq EV_{DD} \leq 5.5\text{ V}$ , $I_{OH1} = -10.0\text{ mA}$			$EV_{DD} - 1.5$	V
			$4.0\text{ V} \leq EV_{DD} \leq 5.5\text{ V}$ , $I_{OH1} = -3.0\text{ mA}$			$EV_{DD} - 0.7$	V
			$2.7\text{ V} \leq EV_{DD} \leq 5.5\text{ V}$ , $I_{OH1} = -2.0\text{ mA}$			$EV_{DD} - 0.6$	V
			$1.9\text{ V} \leq EV_{DD} \leq 5.5\text{ V}$ , $I_{OH1} = -1.5\text{ mA}$			$EV_{DD} - 0.5$	V
			$1.7\text{ V} \leq EV_{DD} \leq 5.5\text{ V}$ , $I_{OH1} = -1.0\text{ mA}$			$EV_{DD} - 0.5$	V
	$V_{OH2}$	P20 to P25, P150 to P152	$1.7\text{ V} \leq V_{DD}^{\text{Note}} \leq 5.5\text{ V}$ , $I_{OH2} = -100\text{ }\mu\text{A}$			$V_{DD} - 0.5$	V
Output voltage, low	$V_{OL1}$	P02 to P07, P10 to P17, P30 to P37, P40 to P43, P50 to P57, P70 to P77, P80 to P85, P125 to P127	$4.0\text{ V} \leq EV_{DD} \leq 5.5\text{ V}$ , $I_{OL1} = 20\text{ mA}$			1.3	V
			$4.0\text{ V} \leq EV_{DD} \leq 5.5\text{ V}$ , $I_{OL1} = 8.5\text{ mA}$			0.7	V
			$2.7\text{ V} \leq EV_{DD} \leq 5.5\text{ V}$ , $I_{OL1} = 3.0\text{ mA}$			0.6	V
			$2.7\text{ V} \leq EV_{DD} \leq 5.5\text{ V}$ , $I_{OL1} = 1.5\text{ mA}$			0.4	V
			$1.9\text{ V} \leq EV_{DD} \leq 5.5\text{ V}$ , $I_{OL1} = 0.6\text{ mA}$			0.4	V
			$1.7\text{ V} \leq EV_{DD} \leq 5.5\text{ V}$ , $I_{OL1} = 0.3\text{ mA}$			0.4	V
	$V_{OL2}$	P20 to P25, P150 to P152	$1.7\text{ V} \leq V_{DD}^{\text{Note}} \leq 5.5\text{ V}$ , $I_{OL2} = 400\text{ }\mu\text{A}$			0.4	V
	$V_{OL3}$	P60 to P62	$4.0\text{ V} \leq EV_{DD} \leq 5.5\text{ V}$ , $I_{OL3} = 15.0\text{ mA}$			2.0	V
			$4.0\text{ V} \leq EV_{DD} \leq 5.5\text{ V}$ , $I_{OL3} = 5.0\text{ mA}$			0.4	V
			$2.7\text{ V} \leq EV_{DD} \leq 5.5\text{ V}$ , $I_{OL3} = 3.0\text{ mA}$			0.4	V
			$1.9\text{ V} \leq EV_{DD} \leq 5.5\text{ V}$ , $I_{OL3} = 2.0\text{ mA}$			0.4	V
			$1.7\text{ V} \leq EV_{DD} \leq 5.5\text{ V}$ , $I_{OL3} = 1.0\text{ mA}$			0.4	V

**Note** Either  $V_{DD}$  or  $V_{BAT}$  is selected by the battery backup function.

**Caution** P02 to P07, P12 to P17, P31, P56, P57, P80 to P82, P84, and P85 do not output high level in N-ch open-drain mode.

**Remark** Unless specified otherwise, the characteristics of alternate-function pins are the same as those of the port pins.

( $T_A = -40$  to  $+85^\circ\text{C}$ ,  $1.7\text{ V} \leq EV_{DD0} = EV_{DD1} \leq V_{DD}^{\text{Note}} \leq 5.5\text{ V}$ ,  $V_{SS} = EV_{SS0} = EV_{SS1} = 0\text{ V}$ )

Items	Symbol	Conditions	MIN.	TYP.	MAX.	Unit		
Input leakage current, high	I <sub>LIH1</sub>	P02 to P07, P10 to P17, P30 to P37, P40 to P43, P50 to P57, P60 to P62, P70 to P77, P80 to P85, P125 to P127	V <sub>I</sub> = EV <sub>DD</sub>		1	μA		
	I <sub>LIH2</sub>	P20 to P25, P137, P150 to P152, RESET	V <sub>I</sub> = V <sub>DD</sub> <sup>Note</sup>		1	μA		
	I <sub>LIH3</sub>	P121, P122 (X1, X2, EXCLK)	V <sub>I</sub> = V <sub>DD</sub> <sup>Note</sup>	In input port or external clock input		1	μA	
				In resonator connection		10	μA	
	I <sub>LIH4</sub>	P123, P124 (EXCLKS)	V <sub>I</sub> = V <sub>RTC</sub>	In input port or external clock input		1	μA	
				In resonator connection		10	μA	
Input leakage current, low	I <sub>LIL1</sub>	P02 to P07, P10 to P17, P30 to P37, P40 to P43, P50 to P57, P70 to P77, P80 to P85, P125 to P127	V <sub>I</sub> = EV <sub>SS</sub>		-1	μA		
	I <sub>LIL2</sub>	P20 to P25, P137, P150 to P152, RESET	V <sub>I</sub> = V <sub>SS</sub>		-1	μA		
	I <sub>LIL3</sub>	P121, P122 (X1, X2, EXCLK)	V <sub>I</sub> = V <sub>SS</sub>	In input port or external clock input		-1	μA	
				In resonator connection		-10	μA	
	I <sub>LIL4</sub>	P123, P124 (EXCLKS)	V <sub>I</sub> = V <sub>SS</sub>	In input port or external clock input		-1	μA	
				In resonator connection		-10	μA	
On-chip pull-up resistance	R <sub>U1</sub>	P10 to P17, P30 to P37, P50 to P57, P70 to P77, P80 to P85, P125 to P127	V <sub>I</sub> = EV <sub>SS</sub>	2.4 V ≤ EV <sub>DD</sub> ≤ 5.5 V	10	20	100	kΩ
				1.7 V ≤ EV <sub>DD</sub> ≤ 5.5 V	10	30	100	kΩ
	R <sub>U2</sub>	P02 to P07, P40 to P43, P150 to P152	V <sub>I</sub> = EV <sub>SS</sub>	10	20	100	kΩ	

**Note** Either V<sub>DD</sub> or V<sub>BAT</sub> is selected by the battery backup function.

**Remark** Unless specified otherwise, the characteristics of alternate-function pins are the same as those of the port pins.

## 2.3.2 Supply current characteristics

(TA = -40 to +85°C, 1.7 V ≤ EVDD0 = EVDD1 ≤ VDD<sup>Note 8</sup> ≤ 5.5 V, VSS = EVSS0 = EVSS1 = 0 V)

(1/6)

Parameter	Symbol	Conditions				MIN.	TYP.	MAX.	Unit	
Supply current <sup>Note 1</sup>	I <sub>DD1</sub>	Operating mode	HS (high-speed main) mode <sup>Note 5</sup>	f <sub>CLK</sub> = 32 MHz <sup>Note 3</sup> PLL operation	Normal operation	V <sub>DD</sub> = 5.0 V		5.2	8.5	mA
						V <sub>DD</sub> = 3.0 V		5.2	8.5	mA
				Basic operation	f <sub>IH</sub> = 24 MHz <sup>Note 3</sup>	V <sub>DD</sub> = 5.0 V		1.7		mA
						V <sub>DD</sub> = 3.0 V		1.7		mA
					Normal operation	V <sub>DD</sub> = 5.0 V		3.9	6.6	mA
						V <sub>DD</sub> = 3.0 V		3.9	6.6	mA
			f <sub>IH</sub> = 12 MHz <sup>Note 3</sup>	Normal operation	V <sub>DD</sub> = 5.0 V		2.4	3.8	mA	
					V <sub>DD</sub> = 3.0 V		2.4	3.8	mA	
			f <sub>IH</sub> = 6 MHz <sup>Note 3</sup>	Normal operation	V <sub>DD</sub> = 5.0 V		1.7	2.6	mA	
					V <sub>DD</sub> = 3.0 V		1.7	2.6	mA	
			f <sub>IH</sub> = 3 MHz <sup>Note 3</sup>	Normal operation	V <sub>DD</sub> = 5.0 V		1.3	2.0	mA	
					V <sub>DD</sub> = 3.0 V		1.3	2.0	mA	
			LS (low-speed main) mode <sup>Note 5</sup>	f <sub>IH</sub> = 8 MHz <sup>Note 3</sup>	Normal operation	V <sub>DD</sub> = 3.0 V		1.3	2.2	mA
						V <sub>DD</sub> = 2.0 V		1.3	2.2	mA
				f <sub>IH</sub> = 6 MHz <sup>Note 3</sup>	Normal operation	V <sub>DD</sub> = 3.0 V		1.1	2.1	mA
						V <sub>DD</sub> = 2.0 V		1.1	2.1	mA
				f <sub>IH</sub> = 4 MHz <sup>Note 3</sup>	Normal operation	V <sub>DD</sub> = 3.0 V		0.84	1.40	mA
						V <sub>DD</sub> = 2.0 V		0.84	1.40	mA
			f <sub>IM</sub> = 4 MHz <sup>Note 6</sup>	Normal operation	V <sub>DD</sub> = 3.0 V		0.70	1.20	mA	
					V <sub>DD</sub> = 2.0 V		0.70	1.20	mA	
f <sub>IH</sub> = 3 MHz <sup>Note 3</sup>	Normal operation	V <sub>DD</sub> = 3.0 V		0.7	1.4	mA				
		V <sub>DD</sub> = 2.0 V		0.7	1.4	mA				
LV (low-voltage main) mode <sup>Note 5</sup>	f <sub>IH</sub> = 4 MHz <sup>Note 3</sup>	Normal operation	V <sub>DD</sub> = 3.0 V		1.3	1.9	mA			
			V <sub>DD</sub> = 2.0 V		1.3	1.9	mA			
LP (low-power main) mode <sup>Note 5</sup>	f <sub>IH</sub> = 1 MHz <sup>Note 3</sup>	Normal operation	V <sub>DD</sub> = 3.0 V		315	530	μA			
			V <sub>DD</sub> = 2.0 V		315	530	μA			
	f <sub>IM</sub> = 1 MHz <sup>Note 6</sup>	Normal operation	V <sub>DD</sub> = 3.0 V		160	300	μA			
			V <sub>DD</sub> = 2.0 V		160	300	μA			

(Notes and Remarks are listed on the page after the next page.)

( $T_A = -40$  to  $+85^\circ\text{C}$ ,  $1.7\text{ V} \leq EV_{DD0} = EV_{DD1} \leq V_{DD} \text{Note } 8 \leq 5.5\text{ V}$ ,  $V_{SS} = EV_{SS0} = EV_{SS1} = 0\text{ V}$ ) (2/6)

Parameter	Symbol	Conditions				MIN.	TYP.	MAX.	Unit	
Supply current <sup>Note 1</sup>	I <sub>DD1</sub>	Operating mode	HS (high-speed main) mode <sup>Note 5</sup>	f <sub>MX</sub> = 20 MHz <sup>Note 2</sup> , V <sub>DD</sub> = 5.0 V	Normal operation	Square wave input		3.3	5.5	mA
						Resonator connection		3.5	5.7	mA
				f <sub>MX</sub> = 20 MHz <sup>Note 2</sup> , V <sub>DD</sub> = 3.0 V	Normal operation	Square wave input		3.3	5.5	mA
						Resonator connection		3.5	5.7	mA
				f <sub>MX</sub> = 16 MHz <sup>Note 2</sup> , V <sub>DD</sub> = 5.0 V	Normal operation	Square wave input		2.8	4.4	mA
						Resonator connection		2.9	4.6	mA
				f <sub>MX</sub> = 16 MHz <sup>Note 2</sup> , V <sub>DD</sub> = 3.0 V	Normal operation	Square wave input		2.8	4.4	mA
						Resonator connection		2.9	4.6	mA
				f <sub>MX</sub> = 12 MHz <sup>Note 2</sup> , V <sub>DD</sub> = 5.0 V	Normal operation	Square wave input		2.3	3.6	mA
						Resonator connection		2.4	3.7	mA
				f <sub>MX</sub> = 12 MHz <sup>Note 2</sup> , V <sub>DD</sub> = 3.0 V	Normal operation	Square wave input		2.3	3.6	mA
						Resonator connection		2.4	3.7	mA
			f <sub>MX</sub> = 10 MHz <sup>Note 2</sup> , V <sub>DD</sub> = 5.0 V	Normal operation	Square wave input		2.0	3.2	mA	
					Resonator connection		2.1	3.3	mA	
			f <sub>MX</sub> = 10 MHz <sup>Note 2</sup> , V <sub>DD</sub> = 3.0 V	Normal operation	Square wave input		2.0	3.2	mA	
					Resonator connection		2.1	3.3	mA	
			LS (low-speed main) mode <sup>Note 5</sup>	f <sub>MX</sub> = 8 MHz <sup>Note 2</sup> , V <sub>DD</sub> = 3.0 V	Normal operation	Square wave input		1.1	2.0	mA
						Resonator connection		1.2	2.1	mA
				f <sub>MX</sub> = 8 MHz <sup>Note 2</sup> , V <sub>DD</sub> = 2.0 V	Normal operation	Square wave input		1.1	2.0	mA
						Resonator connection		1.2	2.1	mA
				f <sub>MX</sub> = 4 MHz <sup>Note 2</sup> , V <sub>DD</sub> = 3.0 V	Normal operation	Square wave input		0.7	1.2	mA
						Resonator connection		0.7	1.3	mA
				f <sub>MX</sub> = 4 MHz <sup>Note 2</sup> , V <sub>DD</sub> = 2.0 V	Normal operation	Square wave input		0.7	1.2	mA
						Resonator connection		0.7	1.3	mA
			LP (low-power main) mode <sup>Note 5</sup>	f <sub>IH</sub> = 1 MHz <sup>Note 2</sup> , V <sub>DD</sub> = 3.0 V	Normal operation	Square wave input		140	240	μA
						Resonator connection		190	300	μA
				f <sub>IH</sub> = 1 MHz <sup>Note 2</sup> , V <sub>DD</sub> = 2.0 V	Normal operation	Square wave input		140	240	μA
						Resonator connection		190	300	μA
Subclock operation	f <sub>SUB</sub> = 32.768 kHz <sup>Note 4</sup> , T <sub>A</sub> = -40°C	Normal operation	Square wave input		5.1	6.6	μA			
			Resonator connection		5.2	6.7	μA			
	f <sub>SUB</sub> = 32.768 kHz <sup>Note 4</sup> , T <sub>A</sub> = +25°C	Normal operation	Square wave input		5.4	7.1	μA			
			Resonator connection		5.5	7.2	μA			
	f <sub>SUB</sub> = 32.768 kHz <sup>Note 4</sup> , T <sub>A</sub> = +50°C	Normal operation	Square wave input		5.6	8.0	μA			
			Resonator connection		5.7	8.1	μA			
	f <sub>SUB</sub> = 32.768 kHz <sup>Note 4</sup> , T <sub>A</sub> = +70°C	Normal operation	Square wave input		6.1	9.7	μA			
			Resonator connection		6.2	9.8	μA			
f <sub>SUB</sub> = 32.768 kHz <sup>Note 4</sup> , T <sub>A</sub> = +85°C	Normal operation	Square wave input		6.8	13.7	μA				
		Resonator connection		6.9	13.8	μA				
f <sub>IL</sub> = 15 kHz, T <sub>A</sub> = +85°C <sup>Note 7</sup>	Normal operation			2.5	7.0	μA				
f <sub>IL</sub> = 15 kHz, T <sub>A</sub> = -40°C <sup>Note 7</sup>	Normal operation			2.8	7.0	μA				
f <sub>IL</sub> = 15 kHz, T <sub>A</sub> = +25°C <sup>Note 7</sup>	Normal operation			4.1	11.0	μA				

(Notes and Remarks are listed on the next page.)

- Notes**
1. Total current flowing into  $V_{DD}$ ,  $EV_{DD}$ , and  $V_{RTC}$  including the input leakage current flowing when the level of the input pin is fixed to  $V_{DD}$ ,  $EV_{DD}$  or  $V_{SS}$ ,  $EV_{SS}$ . The values below the MAX. column include the peripheral operation current. However, not including the current flowing into the LCD controller/driver, A/D converter,  $\Delta\Sigma$  A/D converter, LVD circuit, battery backup circuit, I/O port, and on-chip pull-up/pull-down resistors. When the VBAT pin (pin for battery backup) is selected, current flowing into VBAT.
  2. When high-speed on-chip oscillator, middle-speed on-chip oscillator, low-speed on-chip oscillator, and subsystem clock are stopped.
  3. When high-speed system clock, middle-speed on-chip oscillator, low-speed on-chip oscillator, and subsystem clock are stopped.
  4. When high-speed on-chip oscillator, middle-speed on-chip oscillator, and high-speed system clock are stopped. When setting ultra-low current consumption (AMPHS1 = 1). However, not including the current flowing into Independent power supply RTC, 12-bit interval timer, and watchdog timer.
  5. Relationship between operation voltage width, operation frequency of CPU and operation mode is as below.
    - HS (high-speed main) mode:  $2.8\text{ V} \leq V_{DD} \leq 5.5\text{ V}@1\text{ MHz to }32\text{ MHz}$
    - $2.7\text{ V} \leq V_{DD} \leq 5.5\text{ V}@1\text{ MHz to }24\text{ MHz}$
    - $2.5\text{ V} \leq V_{DD} \leq 5.5\text{ V}@1\text{ MHz to }16\text{ MHz}$
    - $2.4\text{ V} \leq V_{DD} \leq 5.5\text{ V}@1\text{ MHz to }12\text{ MHz}$
    - $2.1\text{ V} \leq V_{DD} \leq 5.5\text{ V}@1\text{ MHz to }6\text{ MHz}$
    - LS (low-speed main) mode:  $1.9\text{ V} \leq V_{DD} \leq 5.5\text{ V}@1\text{ MHz to }8\text{ MHz}$
    - LP (low-power main) mode:  $1.9\text{ V} \leq V_{DD} \leq 5.5\text{ V}@1\text{ MHz}$
    - LV (low-voltage main) mode:  $1.7\text{ V} \leq V_{DD} \leq 5.5\text{ V}@1\text{ MHz to }4\text{ MHz}$
  6. When high-speed on-chip oscillator, low-speed on-chip oscillator, high-speed system clock, and subsystem clock are stopped.
  7. When high-speed on-chip oscillator, middle-speed on-chip oscillator, high-speed system clock, and subsystem clock are stopped.
  8. Either  $V_{DD}$  or VBAT is selected by the battery backup function.

- Remarks**
1.  $f_{MX}$ : High-speed system clock frequency (X1 clock oscillation frequency or external main system clock frequency)
  2.  $f_{IH}$ : High-speed on-chip oscillator clock frequency
  3.  $f_{IM}$ : Middle-speed on-chip oscillator clock frequency
  4.  $f_{IL}$ : Low-speed on-chip oscillator clock frequency
  5.  $f_{SUB}$ : Subsystem clock frequency (XT1 clock oscillation frequency)
  6. Except subsystem clock operation, temperature condition of the TYP. value is  $T_A = 25^\circ\text{C}$

(TA = -40 to +85°C, 1.7 V ≤ EVDD0 = EVDD1 ≤ VDD<sup>Note 10</sup> ≤ 5.5 V, VSS = EVSS0 = EVSS1 = 0 V) (3/6)

Parameter	Symbol	Conditions		MIN.	TYP.	MAX.	Unit	
Supply current <sup>Note 1</sup>	IDD2 <sup>Note 2</sup>	HALT mode	HS (high-speed main) mode <sup>Note 7</sup>	f <sub>CLK</sub> = 32 MHz <sup>Note 4</sup> , PLL operation	V <sub>DD</sub> = 5.0 V	0.80	2.0	mA
					V <sub>DD</sub> = 3.0 V	0.80	2.0	mA
				f <sub>IH</sub> = 24 MHz <sup>Note 4</sup>	V <sub>DD</sub> = 5.0 V	0.48	1.45	mA
					V <sub>DD</sub> = 3.0 V	0.48	1.45	mA
				f <sub>IH</sub> = 12 MHz <sup>Note 4</sup>	V <sub>DD</sub> = 5.0 V	0.37	0.91	mA
					V <sub>DD</sub> = 3.0 V	0.37	0.91	mA
			f <sub>IH</sub> = 6 MHz <sup>Note 4</sup>	V <sub>DD</sub> = 5.0 V	0.32	0.63	mA	
				V <sub>DD</sub> = 3.0 V	0.32	0.63	mA	
			f <sub>IH</sub> = 3 MHz <sup>Note 4</sup>	V <sub>DD</sub> = 5.0 V	0.29	0.49	mA	
				V <sub>DD</sub> = 3.0 V	0.29	0.49	mA	
			LS (low-speed main) mode <sup>Note 7</sup>	f <sub>IH</sub> = 8 MHz <sup>Note 4</sup>	V <sub>DD</sub> = 3.0 V	280	740	μA
					V <sub>DD</sub> = 2.0 V	280	740	μA
				f <sub>IH</sub> = 6 MHz <sup>Note 4</sup>	V <sub>DD</sub> = 3.0 V	230	620	μA
					V <sub>DD</sub> = 2.0 V	230	620	μA
				f <sub>IH</sub> = 4 MHz <sup>Note 4</sup>	V <sub>DD</sub> = 3.0 V	220	440	μA
					V <sub>DD</sub> = 2.0 V	220	440	μA
				f <sub>IM</sub> = 4 MHz <sup>Note 9</sup>	V <sub>DD</sub> = 3.0 V	55	300	μA
					V <sub>DD</sub> = 2.0 V	55	300	μA
		f <sub>IH</sub> = 3 MHz <sup>Note 4</sup>		V <sub>DD</sub> = 3.0 V	200	534	μA	
				V <sub>DD</sub> = 2.0 V	200	534	μA	
		LV (low-voltage main) mode <sup>Note 7</sup>	f <sub>IH</sub> = 4 MHz <sup>Note 4</sup>	V <sub>DD</sub> = 3.0 V	450	825	μA	
				V <sub>DD</sub> = 2.0 V	450	825	μA	
		LP (low-power main) mode <sup>Note 7</sup>	f <sub>IH</sub> = 1 MHz <sup>Note 4</sup>	V <sub>DD</sub> = 3.0 V	195	400	μA	
				V <sub>DD</sub> = 2.0 V	195	400	μA	
			f <sub>IM</sub> = 1 MHz <sup>Note 9</sup>	V <sub>DD</sub> = 3.0 V	33	100	μA	
				V <sub>DD</sub> = 2.0 V	33	100	μA	
		HS (high-speed main) mode <sup>Note 7</sup>	f <sub>MX</sub> = 20 MHz <sup>Note 3</sup> , V <sub>DD</sub> = 5.0 V	Square wave input	0.31	1.08	mA	
				Resonator connection	0.48	1.28	mA	
			f <sub>MX</sub> = 20 MHz <sup>Note 3</sup> , V <sub>DD</sub> = 3.0 V	Square wave input	0.31	1.08	mA	
				Resonator connection	0.48	1.28	mA	
			f <sub>MX</sub> = 16 MHz <sup>Note 3</sup> , V <sub>DD</sub> = 5.0 V	Square wave input	0.28	0.86	mA	
				Resonator connection	0.42	1.00	mA	
			f <sub>MX</sub> = 16 MHz <sup>Note 3</sup> , V <sub>DD</sub> = 3.0 V	Square wave input	0.28	0.86	mA	
				Resonator connection	0.42	1.00	mA	
			f <sub>MX</sub> = 12 MHz <sup>Note 3</sup> , V <sub>DD</sub> = 5.0 V	Square wave input	0.23	0.70	mA	
				Resonator connection	0.37	0.79	mA	
f <sub>MX</sub> = 12 MHz <sup>Note 3</sup> , V <sub>DD</sub> = 3.0 V	Square wave input		0.23	0.70	mA			
	Resonator connection		0.36	0.79	mA			
f <sub>MX</sub> = 10 MHz <sup>Note 3</sup> , V <sub>DD</sub> = 5.0 V	Square wave input		0.21	0.63	mA			
	Resonator connection		0.29	0.71	mA			
f <sub>MX</sub> = 10 MHz <sup>Note 3</sup> , V <sub>DD</sub> = 3.0 V	Square wave input	0.21	0.63	mA				
	Resonator connection	0.28	0.71	mA				

(Notes and Remarks are listed on the page after the next page.)

(T<sub>A</sub> = -40 to +85°C, 1.7 V ≤ E<sub>VDD0</sub> = E<sub>VDD1</sub> ≤ V<sub>DD</sub><sup>Note 10</sup> ≤ 5.5 V, V<sub>SS</sub> = E<sub>VSS0</sub> = E<sub>VSS1</sub> = 0 V) (4/6)

Parameter	Symbol	Conditions				MIN.	TYP.	MAX.	Unit
Supply current <sup>Note 1</sup>	I <sub>DD2</sub> <sup>Note 2</sup>	HALT mode	LS (low-speed main) mode <sup>Note 7</sup>	f <sub>MX</sub> = 8 MHz <sup>Note 3</sup> , V <sub>DD</sub> = 3.0 V	Square wave input		110	360	μA
					Resonator connection		160	420	μA
				f <sub>MX</sub> = 8 MHz <sup>Note 3</sup> , V <sub>DD</sub> = 2.0 V	Square wave input		110	360	μA
					Resonator connection		160	420	μA
				f <sub>MX</sub> = 4 MHz <sup>Note 3</sup> , V <sub>DD</sub> = 3.0 V	Square wave input		39	200	μA
					Resonator connection		81	250	μA
				f <sub>MX</sub> = 4 MHz <sup>Note 3</sup> , V <sub>DD</sub> = 2.0 V	Square wave input		39	200	μA
					Resonator connection		81	250	μA
			LP (low-power main) mode <sup>Note 7</sup>	f <sub>MX</sub> = 1 MHz <sup>Note 3</sup> , V <sub>DD</sub> = 3.0 V	Square wave input		14	100	μA
					Resonator connection		70	200	μA
				f <sub>MX</sub> = 1 MHz <sup>Note 3</sup> , V <sub>DD</sub> = 2.0 V	Square wave input		14	100	μA
					Resonator connection		70	200	μA
			Subsystem clock operation	f <sub>SUB</sub> = 32.768 kHz <sup>Note 5</sup> , T <sub>A</sub> = -40°C	Square wave input		0.80	1.60	μA
					Resonator connection		1.00	1.80	μA
		f <sub>SUB</sub> = 32.768 kHz <sup>Note 5</sup> , T <sub>A</sub> = +25°C		Square wave input		0.93	1.70	μA	
				Resonator connection		1.13	1.90	μA	
		f <sub>SUB</sub> = 32.768 kHz <sup>Note 5</sup> , T <sub>A</sub> = +50°C		Square wave input		1.10	3.00	μA	
				Resonator connection		1.30	3.20	μA	
		f <sub>SUB</sub> = 32.768 kHz <sup>Note 5</sup> , T <sub>A</sub> = +70°C		Square wave input		1.50	5.00	μA	
				Resonator connection		1.70	5.20	μA	
		f <sub>SUB</sub> = 32.768 kHz <sup>Note 5</sup> , T <sub>A</sub> = +85°C		Square wave input		2.80	9.00	μA	
				Resonator connection		3.00	9.20	μA	
I <sub>DD3</sub> <sup>Note 6</sup>	STOP mode <sup>Note 8</sup>	T <sub>A</sub> = -40°C			0.47	0.90	μA		
		T <sub>A</sub> = +25°C			0.65	1.20	μA		
		T <sub>A</sub> = +50°C			0.84	2.80	μA		
		T <sub>A</sub> = +70°C			1.21	4.70	μA		
T <sub>A</sub> = +85°C			1.82	9.00	μA				

(Notes and Remarks are listed on the next page.)



- Notes**
1. Total current flowing into  $V_{DD}$ ,  $EV_{DD}$ , and  $V_{RTC}$  including the input leakage current flowing when the level of the input pin is fixed to  $V_{DD}$ ,  $EV_{DD}$  or  $V_{SS}$ ,  $EV_{SS}$ . The values below the MAX. column include the peripheral operation current. However, not including the current flowing into the LCD controller/driver, A/D converter,  $\Delta\Sigma$  A/D converter, LVD circuit, battery backup circuit, I/O port, and on-chip pull-up/pull-down resistors. When the VBAT pin (pin for battery backup) is selected, current flowing into VBAT.
  2. During HALT instruction execution by flash memory.
  3. When high-speed on-chip oscillator, middle-speed on-chip oscillator, low-speed on-chip oscillator, and subsystem clock are stopped.
  4. When high-speed system clock, middle-speed on-chip oscillator, low-speed on-chip oscillator, and subsystem clock are stopped.
  5. When operating independent power supply RTC and setting ultra-low current consumption (AMPHS1 = 1). When high-speed on-chip oscillator, middle-speed on-chip oscillator, and high-speed system clock are stopped. However, not including the current flowing into the 12-bit interval timer and watchdog timer.
  6. When high-speed on-chip oscillator, high-speed system clock, and subsystem clock are stopped. However, not including the current flowing into independent power supply RTC, 12-bit interval timer, and watchdog timer.
  7. Relationship between operation voltage width, operation frequency of CPU and operation mode is as below.
    - HS (high-speed main) mode:  $2.8\text{ V} \leq V_{DD} \leq 5.5\text{ V}@1\text{ MHz to }32\text{ MHz}$
    - $2.7\text{ V} \leq V_{DD} \leq 5.5\text{ V}@1\text{ MHz to }24\text{ MHz}$
    - $2.5\text{ V} \leq V_{DD} \leq 5.5\text{ V}@1\text{ MHz to }16\text{ MHz}$
    - $2.4\text{ V} \leq V_{DD} \leq 5.5\text{ V}@1\text{ MHz to }12\text{ MHz}$
    - $2.1\text{ V} \leq V_{DD} \leq 5.5\text{ V}@1\text{ MHz to }6\text{ MHz}$
    - LS (low-speed main) mode:  $1.9\text{ V} \leq V_{DD} \leq 5.5\text{ V}@1\text{ MHz to }8\text{ MHz}$
    - LP (low-power main) mode:  $1.9\text{ V} \leq V_{DD} \leq 5.5\text{ V}@1\text{ MHz}$
    - LV (low-voltage main) mode:  $1.7\text{ V} \leq V_{DD} \leq 5.5\text{ V}@1\text{ MHz to }4\text{ MHz}$
  8. If operation of the subsystem clock when STOP mode, same as when HALT mode of subsystem clock operation.
  9. When high-speed on-chip oscillator, middle-speed on-chip oscillator, and high-speed system clock are stopped.
  10. Either  $V_{DD}$  or VBAT is selected by the battery backup function.

- Remarks**
1.  $f_{MX}$ : High-speed system clock frequency (X1 clock oscillation frequency or external main system clock frequency)
  2.  $f_{IH}$ : High-speed on-chip oscillator clock frequency
  3.  $f_{IM}$ : Middle-speed on-chip oscillator clock frequency
  4.  $f_{IL}$ : Low-speed on-chip oscillator clock frequency
  5.  $f_{SUB}$ : Subsystem clock frequency (XT1 clock oscillation frequency)
  6. Except subsystem clock operation and STOP mode, temperature condition of the TYP. value is  $T_A = 25^\circ\text{C}$

(TA = -40 to +85°C, 1.7 V ≤ EVDD0 = EVDD1 ≤ VDD<sup>Note 15</sup> ≤ 5.5 V, VSS = EVSS0 = EVSS1 = 0 V) (5/6)

Parameter	Symbol	Conditions		MIN.	TYP.	MAX.	Unit
Independent power supply RTC operating current	I <sub>RTC</sub> <sup>Notes 3</sup>	f <sub>SUB</sub> = 32.768 kHz			0.70		μA
12-bit interval timer operating current	I <sub>TMKA</sub> <sup>Notes 1, 2, 4</sup>	f <sub>SUB</sub> = 32.768 kHz, f <sub>MAIN</sub> is stopped			0.04		μA
8-bit interval timer operating current	I <sub>TMT</sub> <sup>Notes 1, 2, 5</sup>	f <sub>SUB</sub> = 32.768 kHz, f <sub>MAIN</sub> is stopped, per unit	8-bit counter mode × 2 ch operation		0.12		μA
			16-bit counter mode operation		0.10		μA
Watchdog timer operating current	I <sub>WDT</sub> <sup>Notes 1, 2, 6</sup>	f <sub>IL</sub> = 15 kHz, f <sub>MAIN</sub> is stopped			0.22		μA
LVD operating current	I <sub>LVD</sub> <sup>Notes 1, 7</sup>				0.10		μA
LVDVDD operating current	I <sub>LVDVDD</sub>	Current flowing to V <sub>DD</sub>			0.05		μA
		Current flowing to V <sub>DD</sub> or VBAT <sup>Note 1</sup>			0.04		μA
LVDVBAT operating current	I <sub>LVDVBAT</sub>	Current flowing to VBAT			0.04		μA
		Current flowing to V <sub>DD</sub> or VBAT <sup>Note 1</sup>			0.04		μA
LVDVRTC operating current	I <sub>LVDVRTC</sub>	Current flowing to VRTC			0.04		μA
		Current flowing to V <sub>DD</sub> or VBAT <sup>Note 1</sup>			0.04		μA
LVDEXLVD operating current	I <sub>LVDEXLVD</sub>	Current flowing to EXLVD			0.16		μA
		Current flowing to V <sub>DD</sub> or VBAT <sup>Note 1</sup>			0.04		μA
Oscillation stop detection circuit operating current	I <sub>OSDC</sub> <sup>Note 1</sup>				0.02		μA
Battery backup circuit operating current	I <sub>BUP</sub> <sup>Note 1</sup>				0.05		μA
A/D converter operating current	I <sub>ADC</sub> <sup>Notes 1, 8</sup>	When conversion at maximum speed	Normal mode, AV <sub>REFP</sub> = V <sub>DD</sub> = 5.0 V		1.3	2.4	mA
			Low voltage mode, AV <sub>REFP</sub> = V <sub>DD</sub> = 3.0 V		0.5	1.0	mA
A/D converter reference voltage current	I <sub>ADREF</sub> <sup>Note 1</sup>				75.0		μA
Temperature sensor operating current	I <sub>TMPS</sub> <sup>Note 1</sup>				105		μA
BGO operating current	I <sub>BGO</sub> <sup>Notes 1, 9</sup>				2.00	12.20	mA
Self-programming operating current	I <sub>FSP</sub> <sup>Notes 1, 10</sup>				2.00	12.20	mA

(Notes and Remarks are listed on the next page.)

( $T_A = -40$  to  $+85^\circ\text{C}$ ,  $1.7\text{ V} \leq EV_{DD0} = EV_{DD1} \leq V_{DD} \text{Note } 15 \leq 5.5\text{ V}$ ,  $V_{SS} = EV_{SS0} = EV_{SS1} = 0\text{ V}$ ) (6/6)

Parameter	Symbol	Conditions		MIN.	TYP.	MAX.	Unit
24-Bit $\Delta\Sigma$ A/D Converter operating current	$I_{DSAD}$ Notes 1, 11	In 4 ch $\Delta\Sigma$ A/D converter operation			1.45	2.30	mA
		In 3 ch $\Delta\Sigma$ A/D converter operation			1.14	1.85	mA
		In 1 ch $\Delta\Sigma$ A/D converter operation			0.52	0.94	mA
SNOOZE operating current	$I_{SNOZ}$ Notes 1, 12	ADC operation	The mode is performed		0.50	0.80	mA
			The A/D conversion operations are performed, low voltage mode, $AV_{REFP} = V_{DD} = 3.0\text{ V}$		1.20	1.80	mA
		Simplified SPI (CSI)/UART operation			0.70	1.05	mA
		DTC operation			2.20		mA
LCD operating current	$I_{LCD1}$ Notes 1, 13, 14	External resistance division method	$f_{LCD} = f_{SUB}$ LCD clock = 128 Hz 1/3 bias, four-time-slices	$V_{DD} = 5.0\text{ V}$ , $V_{L4} = 5.0\text{ V}$		0.06	$\mu\text{A}$
			$f_{LCD} = f_{SUB}$ LCD clock = 128 Hz 1/3 bias, four-time-slices	$V_{DD} = 3.0\text{ V}$ , $V_{L4} = 3.0\text{ V}$ (VLCD = 04H)		0.85	$\mu\text{A}$
	$I_{LCD2}$ Notes 1, 13	Internal voltage boosting method	$f_{LCD} = f_{SUB}$ LCD clock = 128 Hz 1/3 bias, four-time-slices	$V_{DD} = 5.0\text{ V}$ , $V_{L4} = 5.1\text{ V}$ (VLCD = 12H)		1.55	$\mu\text{A}$
			$f_{LCD} = f_{SUB}$ LCD clock = 128 Hz 1/3 bias, four-time-slices	$V_{DD} = 3.0\text{ V}$ , $V_{L4} = 3.0\text{ V}$		0.20	$\mu\text{A}$
$I_{LCD3}$ Notes 1, 13	Capacitor split method	$f_{LCD} = f_{SUB}$ LCD clock = 128 Hz 1/3 bias, four-time-slices	$V_{DD} = 3.0\text{ V}$ , $V_{L4} = 3.0\text{ V}$		0.20	$\mu\text{A}$	

**Notes** 1. Current flowing to  $V_{DD}$ . When the VBAT pin (battery backup power supply pin) is selected, current flowing to the VBAT.

2. When high speed on-chip oscillator and high-speed system clock are stopped.
3. Current flowing to VRTC pin, including RTC power supply, subsystem clock oscillator circuit, and RTC.
4. Current flowing only to the 12-bit interval timer (excluding the operating current of the low-speed on-chip oscillator and XT1 oscillator). The value of the current value of the RL78 microcontrollers is the sum of the values of either  $I_{DD1}$  or  $I_{DD2}$ , and  $I_{TMKA}$ , when the 12-bit interval timer operates in operation mode or HALT mode. When the low-speed on-chip oscillator is selected,  $I_{FIL}$  should be added.
5. Current flowing only to the 8-bit interval timer (excluding the operating current of the low-speed on-chip oscillator and XT1 oscillator). The value of the current value of the RL78 microcontrollers is the sum of the values of either  $I_{DD1}$  or  $I_{DD2}$ , and  $I_{TMT}$ , when the 8-bit interval timer operates in operation mode or HALT mode. When the low-speed on-chip oscillator is selected,  $I_{FIL}$  should be added.
6. Current flowing only to the watchdog timer (including the operating current of the low-speed on-chip oscillator). The current value of the RL78 microcontrollers is the sum of  $I_{DD1}$ ,  $I_{DD2}$  or  $I_{DD3}$  and  $I_{WDT}$  when the watchdog timer operates.
7. Current flowing only to the LVD circuit. The current value of the RL78 microcontrollers is the sum of  $I_{DD1}$ ,  $I_{DD2}$  or  $I_{DD3}$  and  $I_{LVD}$  when the LVD circuit operates.
8. Current flowing only to the A/D converter. The current value of the RL78 microcontrollers is the sum of  $I_{DD1}$  or  $I_{DD2}$  and  $I_{ADC}$  when the A/D converter operates in an operation mode or the HALT mode.
9. Current flowing only during rewrite of 1 KB data flash memory.
10. Current flowing only during self programming.
11. Current flowing only to the 24-bit  $\Delta\Sigma$  A/D converter. The current value of the RL78 microcontrollers is the sum of  $I_{DD1}$  or  $I_{DD2}$ , and  $I_{DSAD}$  when the 24-bit  $\Delta\Sigma$  A/D converter operates.
12. For shift time to the SNOOZE mode, see **26.3.3 SNOOZE mode in the RL78/I1C User's Manual**.

**Notes 13.** Current flowing only to the LCD controller/driver. The current value of the RL78 microcontrollers is the sum of the LCD operating current ( $I_{LCD1}$ ,  $I_{LCD2}$  or  $I_{LCD3}$ ) to the supply current ( $I_{DD1}$ , or  $I_{DD2}$ ) when the LCD controller/driver operates in an operation mode or HALT mode. Not including the current that flows through the LCD panel. Conditions of the TYP. value and MAX. value are as follows.

- Setting 20 pins as the segment function and blinking all
- Selecting  $f_{SUB}$  for system clock when LCD clock = 128 Hz ( $LCDC0 = 07H$ )
- Setting four time slices and 1/3 bias

**14.** Not including the current flowing into the external division resistor when using the external resistance division method.

**15.** Either  $V_{DD}$  or  $V_{BAT}$  is selected by the battery backup function.

- Remarks 1.**  $f_{IL}$ : Low-speed on-chip oscillator clock frequency
- 2.**  $f_{SUB}$ : Subsystem clock frequency (XT1 clock oscillation frequency)
- 3.**  $f_{CLK}$ : CPU/peripheral hardware clock frequency
- 4.** Temperature condition of the TYP. value is  $T_A = 25^\circ\text{C}$

## 2.4 AC Characteristics

(T<sub>A</sub> = -40 to +85°C, 1.7 V ≤ EV<sub>DD0</sub> = EV<sub>DD1</sub> ≤ V<sub>DD</sub><sup>Note 1</sup> ≤ 5.5 V, V<sub>SS</sub> = EV<sub>SS0</sub> = EV<sub>SS1</sub> = 0 V) (1/2)

Items	Symbol	Conditions		MIN.	TYP.	MAX.	Unit	
Instruction cycle (minimum instruction execution time)	T <sub>CY</sub>	Main system clock (f <sub>MAIN</sub> ) operation	HS (high-speed main) mode	2.8 V ≤ V <sub>DD</sub> <sup>Note 1</sup> ≤ 5.5 V	0.03125		1	μs
				2.7 V ≤ V <sub>DD</sub> <sup>Note 1</sup> < 2.8 V	0.04167		1	μs
				2.5 V ≤ V <sub>DD</sub> <sup>Note 1</sup> < 2.7 V	0.0625		1	μs
				2.4 V ≤ V <sub>DD</sub> <sup>Note 1</sup> < 2.5 V	0.08333		1	μs
				2.1 V ≤ V <sub>DD</sub> <sup>Note 1</sup> < 2.4 V	0.16667		1	μs
			LS (low-speed main) mode	1.9 V ≤ V <sub>DD</sub> <sup>Note 1</sup> ≤ 5.5 V	0.125		1	μs
			LS (low-speed main) mode @4 MHz	1.9 V ≤ V <sub>DD</sub> <sup>Note 1</sup> ≤ 5.5 V	0.25		1	μs
			LP (low-power main) mode	1.9 V ≤ V <sub>DD</sub> <sup>Note 1</sup> ≤ 5.5 V	1		2	μs
		LV (low-voltage main) mode	1.7 V ≤ V <sub>DD</sub> <sup>Note 1</sup> ≤ 5.5 V	0.25		1	μs	
		Subsystem clock (f <sub>SUB</sub> ) operation		1.9 V ≤ V <sub>DD</sub> <sup>Note 1</sup> ≤ 5.5 V	28.5	30.5	31.3	μs
		In the self programming mode	HS (high-speed main) mode	2.8 V ≤ V <sub>DD</sub> <sup>Note 1</sup> ≤ 5.5 V	0.03125		1	μs
				2.7 V ≤ V <sub>DD</sub> <sup>Note 1</sup> < 2.8 V	0.04167		1	μs
				2.5 V ≤ V <sub>DD</sub> <sup>Note 1</sup> < 2.7 V	0.0625		1	μs
				2.4 V ≤ V <sub>DD</sub> <sup>Note 1</sup> < 2.5 V	0.08333		1	μs
2.1 V ≤ V <sub>DD</sub> <sup>Note 1</sup> < 2.4 V	0.16667				1	μs		
LS (low-speed main) mode	1.9 V ≤ V <sub>DD</sub> <sup>Note 1</sup> ≤ 5.5 V		0.125		1	μs		
LV (low-voltage main) mode	1.7 V ≤ V <sub>DD</sub> <sup>Note 1</sup> ≤ 5.5 V	0.25		1	μs			
External system clock frequency	f <sub>EX</sub>	2.7 V ≤ V <sub>DD</sub> <sup>Note 1</sup> ≤ 5.5 V		1		20	MHz	
		2.5 V ≤ V <sub>DD</sub> <sup>Note 1</sup> < 2.7 V		1		16	MHz	
		2.4 V ≤ V <sub>DD</sub> <sup>Note 1</sup> < 2.5 V		1		12	MHz	
		1.9 V ≤ V <sub>DD</sub> <sup>Note 1</sup> < 2.4 V		1		8	MHz	
		1.7 V ≤ V <sub>DD</sub> <sup>Note 1</sup> < 1.9 V		1		4	MHz	
	f <sub>EXS</sub>			32		35	kHz	
External system clock input high-level width, low-level width	t <sub>EXH</sub>	2.7 V ≤ V <sub>DD</sub> <sup>Note 1</sup> ≤ 5.5 V		24			ns	
	t <sub>EXL</sub>	2.5 V ≤ V <sub>DD</sub> <sup>Note 1</sup> < 2.7 V		30			ns	
		2.4 V ≤ V <sub>DD</sub> <sup>Note 1</sup> < 2.5 V		40			ns	
		1.9 V ≤ V <sub>DD</sub> <sup>Note 1</sup> < 2.4 V		60			ns	
		1.7 V ≤ V <sub>DD</sub> <sup>Note 1</sup> < 1.9 V		120			ns	
	t <sub>EXHS</sub> , t <sub>EXLS</sub>			13.7			μs	
TI00 to TI07 input high-level width, low-level width	t <sub>TIH</sub> , t <sub>TIL</sub>			1/f <sub>MCK</sub> +10			ns <sup>Note 2</sup>	

(Notes and Remark are listed on the next page.)

( $T_A = -40$  to  $+85^\circ\text{C}$ ,  $1.7\text{ V} \leq EV_{DD0} = EV_{DD1} \leq V_{DD}^{\text{Note 1}} \leq 5.5\text{ V}$ ,  $V_{SS} = EV_{SS0} = EV_{SS1} = 0\text{ V}$ ) (2/2)

Items	Symbol	Conditions	MIN.	TYP.	MAX.	Unit
TO00 to TO07 output frequency	$f_{TO}$	HS (high-speed main) mode	$4.0\text{ V} \leq EV_{DD} \leq 5.5\text{ V}$		16	MHz
			$2.7\text{ V} \leq EV_{DD} < 4.0\text{ V}$		8	MHz
			$2.4\text{ V} \leq EV_{DD} < 2.7\text{ V}$		4	MHz
			$2.1\text{ V} \leq EV_{DD} < 2.4\text{ V}$		4	MHz
		LS (low-speed main) mode	$1.9\text{ V} \leq EV_{DD} \leq 5.5\text{ V}$		4	MHz
		LP (low-power main) mode	$1.9\text{ V} \leq EV_{DD} \leq 5.5\text{ V}$		0.5	MHz
PCLBUZ0, PCLBUZ1 output frequency	$f_{PCL}$	HS (high-speed main) mode	$4.0\text{ V} \leq EV_{DD} \leq 5.5\text{ V}$		16	MHz
			$2.7\text{ V} \leq EV_{DD} < 4.0\text{ V}$		8	MHz
			$2.4\text{ V} \leq EV_{DD} < 2.7\text{ V}$		4	MHz
			$2.1\text{ V} \leq EV_{DD} < 2.4\text{ V}$		4	MHz
		LS (low-speed main) mode	$1.9\text{ V} \leq EV_{DD} \leq 5.5\text{ V}$		4	MHz
		LP (low-power main) mode	$1.9\text{ V} \leq EV_{DD} \leq 5.5\text{ V}$		1	MHz
Interrupt input high-level width, low-level width	$t_{INTH}$ , $t_{INTL}$	INTP0	$1.7\text{ V} \leq V_{DD}^{\text{Note 1}} \leq 5.5\text{ V}$	1		$\mu\text{s}$
		INTP1 to INTP7	$1.7\text{ V} \leq EV_{DD} \leq 5.5\text{ V}$	1		$\mu\text{s}$
Key interrupt input low-level width	$t_{KR}$	KR0 to KR7	$1.9\text{ V} \leq EV_{DD} \leq 5.5\text{ V}$	250		ns
			$1.7\text{ V} \leq EV_{DD} < 1.9\text{ V}$	1		$\mu\text{s}$
$\overline{\text{RESET}}$ low-level width	$t_{RSL}$		10			$\mu\text{s}$

**Notes** 1. Either  $V_{DD}$  or  $V_{BAT}$  is selected by the battery backup function.

2. The following conditions are required for low voltage interface:

$1.9\text{ V} \leq V_{DD} < 2.7\text{ V}$ : MIN. 125 ns

**Remark**  $f_{MCK}$ : Timer array unit operation clock frequency

(Operation clock to be set by the  $CKSmn0$ ,  $CKSmn1$  bits of timer mode register  $mn$  (TMR $mn$ ))

$m$ : Unit number ( $m = 0$ ),  $n$ : Channel number ( $n = 0$  to  $7$ ))

**AC Timing Test Points**

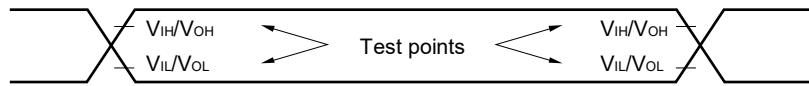

**External System Clock Timing**

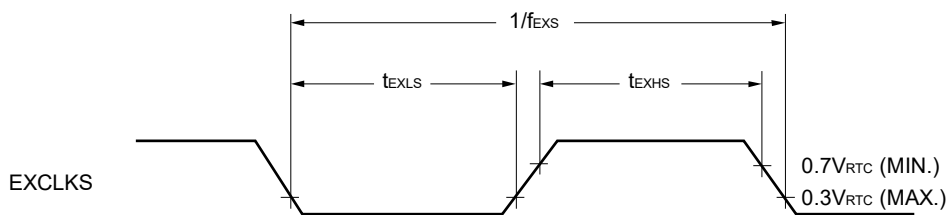
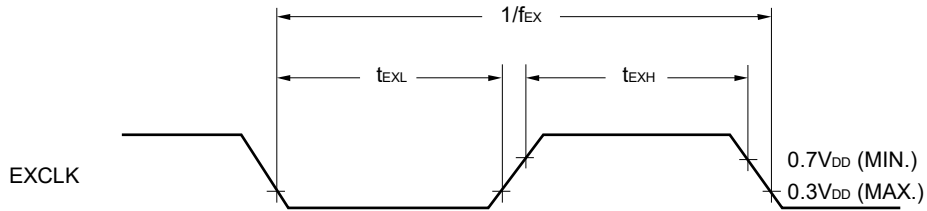

**TI/TO Timing**

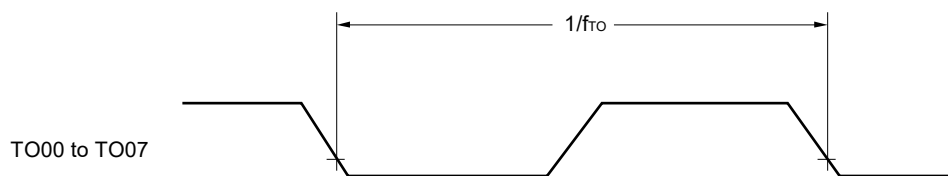
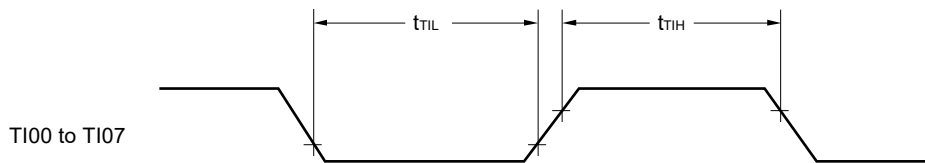

**Interrupt Request Input Timing**

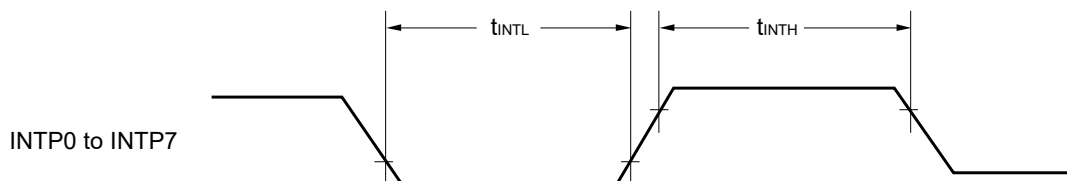

**Key interrupt Input Timing**

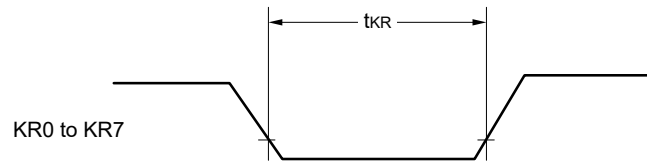

**$\overline{\text{RESET}}$  Input Timing**

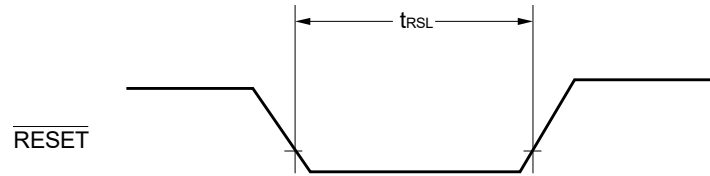



2.5 Peripheral Functions Characteristics

AC Timing Test Points

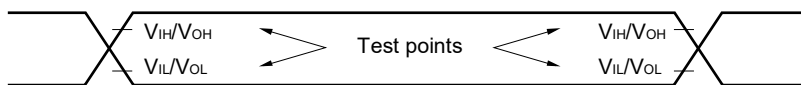

2.5.1 Serial array unit

(1) During communication at same potential (UART mode) (dedicated baud rate generator output)

(TA = -40 to +85°C, 1.7 V ≤ EVDD0 = EVDD1 ≤ VDD<sup>Note 4</sup> ≤ 5.5 V, VSS = EVSS0 = EVSS1 = 0 V)

Parameter	Symbol	Conditions	HS (high-speed main) Mode		LS (low-speed main) Mode		LP (low-power main) Mode		LV (low-voltage main) Mode		Unit
			MIN.	MAX.	MIN.	MAX.	MIN.	MAX.	MIN.	MAX.	
Transfer rate <sup>Note 1</sup>		2.4 V ≤ VDD ≤ 5.5 V		f <sub>MCK</sub> /6 <sup>Note 2</sup>		f <sub>MCK</sub> /6 <sup>Note 2</sup>		f <sub>MCK</sub> /6 <sup>Note 2</sup>		f <sub>MCK</sub> /6 <sup>Note 2</sup>	bps
		Theoretical value of the maximum transfer rate f <sub>MCK</sub> = f <sub>CLK</sub> <sup>Note 3</sup>		4.0		1.3		0.1		0.6	Mbps
		1.9 V ≤ VDD ≤ 5.5 V		f <sub>MCK</sub> /6 <sup>Note 2</sup>		f <sub>MCK</sub> /6 <sup>Note 2</sup>		f <sub>MCK</sub> /6 <sup>Note 2</sup>		f <sub>MCK</sub> /6 <sup>Note 2</sup>	bps
		Theoretical value of the maximum transfer rate f <sub>MCK</sub> = f <sub>CLK</sub> <sup>Note 3</sup>		1.0		1.3		0.1		0.6	Mbps
		1.8 V ≤ VDD ≤ 5.5 V		f <sub>MCK</sub> /6 <sup>Note 2</sup>		f <sub>MCK</sub> /6 <sup>Note 2</sup>		f <sub>MCK</sub> /6 <sup>Note 2</sup>		f <sub>MCK</sub> /6 <sup>Note 2</sup>	bps
		Theoretical value of the maximum transfer rate f <sub>MCK</sub> = f <sub>CLK</sub> <sup>Note 3</sup>		1.0		1.3		0.1		0.6	Mbps
		1.7 V ≤ VDD ≤ 5.5 V								f <sub>MCK</sub> /6 <sup>Note 2</sup>	bps
		Theoretical value of the maximum transfer rate f <sub>MCK</sub> = f <sub>CLK</sub> <sup>Note 3</sup>								0.6	Mbps

- Notes**
- Transfer rate in the SNOOZE mode is 4800 bps only.
  - The following conditions are required for low voltage interface.
    - 2.4 V ≤ EVDD < 2.7 V: MAX. 2.6 Mbps
    - 1.9 V ≤ EVDD < 2.4 V: MAX. 1.3 Mbps
  - The maximum operating frequencies of the CPU/peripheral hardware clock (f<sub>CLK</sub>) are:
    - HS (high-speed main) mode: 32 MHz (2.8 V ≤ EVDD ≤ 5.5 V), 24 MHz (2.7 V ≤ EVDD ≤ 5.5 V), 16 MHz (2.5 V ≤ EVDD ≤ 5.5 V), 12 MHz (2.4 V ≤ EVDD ≤ 5.5 V), 6 MHz (2.1 V ≤ EVDD ≤ 5.5 V),
    - LS (low-speed main) mode: 8 MHz (1.9 V ≤ EVDD ≤ 5.5 V), 4 MHz (1.9 V ≤ EVDD ≤ 5.5 V)
    - LP (low-power main) mode: 1 MHz (1.9 V ≤ EVDD ≤ 5.5 V)
    - LV (low-voltage main) mode: 4 MHz (1.7 V ≤ EVDD ≤ 5.5 V)
  - Either VDD or VBAT is selected by the battery backup function.

**Caution** Select the normal input buffer for the RxDq pin and the normal output mode for the TxDq pin by using port input mode register g (PIMg) and port output mode register g (POMg).

**UART mode connection diagram (during communication at same potential)**

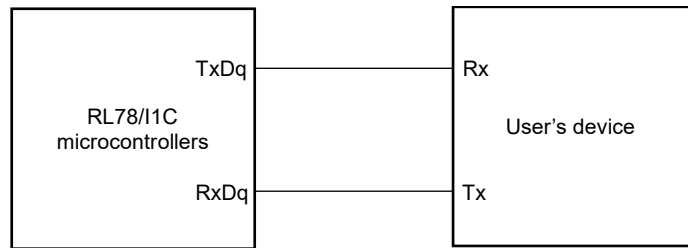

**UART mode bit width (during communication at same potential) (reference)**

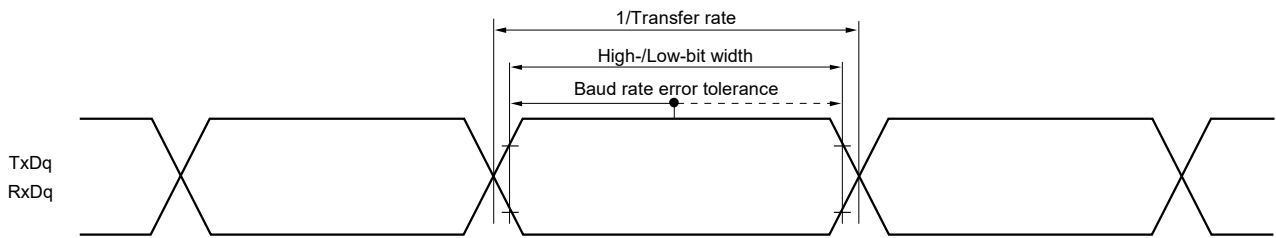

- Remarks**
1. q: UART number (q = 0 to 3), g: PIM and POM number (g = 0, 1, 3, 5, 8)
  2.  $f_{MCK}$ : Serial array unit operation clock frequency  
 (Operating clock that is set with the serial clock select register m (SPSm) and the CKSmn bit of serial mode register mn (SMRmn).  
 m: Unit number, n: Channel number (mn = 00 to 03, 10 to 13))

**(2) During communication at same potential (Simplified SPI (CSI) mode) (master mode, SCKp... internal clock output)****( $T_A = -40$  to  $+85^\circ\text{C}$ ,  $1.7\text{ V} \leq \text{EV}_{\text{DD}0} = \text{EV}_{\text{DD}1} \leq \text{V}_{\text{DD}}^{\text{Note 4}} \leq 5.5\text{ V}$ ,  $\text{V}_{\text{SS}} = \text{EV}_{\text{SS}0} = \text{EV}_{\text{SS}1} = 0\text{ V}$ )**

Parameter	Symbol	Conditions	HS (high-speed main) Mode		LS (low-speed main) Mode		LP (low-power main) Mode		LV (low-voltage main) Mode		Unit
			MIN.	MAX.	MIN.	MAX.	MIN.	MAX.	MIN.	MAX.	
SCKp cycle time	$t_{\text{CY}1}$	$2.7\text{ V} \leq \text{EV}_{\text{DD}} \leq 5.5\text{ V}$	125		500		4000		1000		ns
		$2.4\text{ V} \leq \text{EV}_{\text{DD}} \leq 5.5\text{ V}$	250		500		4000		1000		ns
		$1.9\text{ V} \leq \text{EV}_{\text{DD}} \leq 5.5\text{ V}$	500		500		4000		1000		ns
		$1.8\text{ V} \leq \text{EV}_{\text{DD}} \leq 5.5\text{ V}$	1000		1000		4000		1000		ns
		$1.7\text{ V} \leq \text{EV}_{\text{DD}} \leq 5.5\text{ V}$			1000		4000		1000		ns
SCKp high-/low-level width	$t_{\text{KH}1}$ , $t_{\text{KL}1}$	$4.0\text{ V} \leq \text{EV}_{\text{DD}} \leq 5.5\text{ V}$	$t_{\text{CY}1}/$ 2 – 12		$t_{\text{CY}1}/$ 2 – 50		$t_{\text{CY}1}/$ 2 – 50		$t_{\text{CY}1}/$ 2 – 50		ns
		$2.7\text{ V} \leq \text{EV}_{\text{DD}} \leq 5.5\text{ V}$	$t_{\text{CY}1}/$ 2 – 18		$t_{\text{CY}1}/$ 2 – 50		$t_{\text{CY}1}/$ 2 – 50		$t_{\text{CY}1}/$ 2 – 50		ns
		$2.4\text{ V} \leq \text{EV}_{\text{DD}} \leq 5.5\text{ V}$	$t_{\text{CY}1}/$ 2 – 38		$t_{\text{CY}1}/$ 2 – 50		$t_{\text{CY}1}/$ 2 – 50		$t_{\text{CY}1}/$ 2 – 50		ns
		$1.9\text{ V} \leq \text{EV}_{\text{DD}} \leq 5.5\text{ V}$	$t_{\text{CY}1}/$ 2 – 50		$t_{\text{CY}1}/$ 2 – 50		$t_{\text{CY}1}/$ 2 – 50		$t_{\text{CY}1}/$ 2 – 50		ns
		$1.8\text{ V} \leq \text{EV}_{\text{DD}} \leq 5.5\text{ V}$			$t_{\text{CY}1}/$ 2 – 100		$t_{\text{CY}1}/$ 2 – 100		$t_{\text{CY}1}/$ 2 – 100		ns
		$1.7\text{ V} \leq \text{EV}_{\text{DD}} \leq 5.5\text{ V}$			$t_{\text{CY}1}/$ 2 – 100		$t_{\text{CY}1}/$ 2 – 100		$t_{\text{CY}1}/$ 2 – 100		ns
Slp setup time (to SCKp $\uparrow$ ) <sup>Note 1</sup>	$t_{\text{SIK}1}$	$4.0\text{ V} \leq \text{EV}_{\text{DD}} \leq 5.5\text{ V}$	44		110		110		110		ns
		$2.7\text{ V} \leq \text{EV}_{\text{DD}} \leq 5.5\text{ V}$	44		110		110		110		ns
		$2.4\text{ V} \leq \text{EV}_{\text{DD}} \leq 5.5\text{ V}$	75		110		110		110		ns
		$1.9\text{ V} \leq \text{EV}_{\text{DD}} \leq 5.5\text{ V}$	110		110		110		110		ns
		$1.8\text{ V} \leq \text{EV}_{\text{DD}} \leq 5.5\text{ V}$	220		220		220		220		ns
Slp hold time (from SCKp $\uparrow$ ) <sup>Note 2</sup>	$t_{\text{KS}11}$	$1.8\text{ V} \leq \text{EV}_{\text{DD}} \leq 5.5\text{ V}$	19		19		19		19		ns
		$1.7\text{ V} \leq \text{EV}_{\text{DD}} \leq 5.5\text{ V}$			19		19		19		ns
Delay time from SCKp $\downarrow$ to SOp output <sup>Note 3</sup>	$t_{\text{KS}01}$	$C = 30$ $\mu\text{F}^{\text{Note 3}}$	$1.8\text{ V} \leq \text{EV}_{\text{DD}} \leq 5.5\text{ V}$	25		25		25		25	ns
			$1.7\text{ V} \leq \text{EV}_{\text{DD}} \leq 5.5\text{ V}$			25		25		25	ns

**Notes 1.** When DAPmn = 0 and CKPmn = 0, or DAPmn = 1 and CKPmn = 1. The Slp setup time becomes “to SCKp $\downarrow$ ” when DAPmn = 0 and CKPmn = 1, or DAPmn = 1 and CKPmn = 0.

**2.** When DAPmn = 0 and CKPmn = 0, or DAPmn = 1 and CKPmn = 1. The Slp hold time becomes “from SCKp $\uparrow$ ” when DAPmn = 0 and CKPmn = 1, or DAPmn = 1 and CKPmn = 0.

**3.** C is the load capacitance of the SCKp and SOp output lines.

**4.** Either V<sub>DD</sub> or V<sub>BAT</sub> is selected by the battery backup function.

**Caution** Select the normal input buffer for the Slp pin and the normal output mode for the SOp pin and SCKp pin by using port input mode register g (PIMg) and port output mode register g (POMg).

**Remarks 1.** p: CSI number (p = 00, 10, 30), m: Unit number (m = 0), n: Channel number (n = 0),  
g: PIM and POM numbers (g = 0, 1, 8)

**2.** f<sub>MCK</sub>: Serial array unit operation clock frequency

(Operating clock that is set with the serial clock select register m (SPSm) and the CKSmn bit of serial mode register mn (SMRmn).

m: Unit number, n: Channel number (mn = 00, 10, 30))

## (3) During communication at same potential (Simplified SPI (CSI) mode) (slave mode, SCKp... external clock input)

(T<sub>A</sub> = -40 to +85°C, 1.7 V ≤ EV<sub>DD0</sub> = EV<sub>DD1</sub> ≤ V<sub>DD</sub><sup>Note 5</sup> ≤ 5.5 V, V<sub>SS</sub> = EV<sub>SS0</sub> = EV<sub>SS1</sub> = 0 V)

Parameter	Symbol	Conditions		HS (high-speed main) Mode		LS (low-speed main) Mode		LP (low-power main) Mode		LV (low-voltage main) Mode		Unit	
				MIN.	MAX.	MIN.	MAX.	MIN.	MAX.	MIN.	MAX.		
SCKp cycle time <sup>Note 4</sup>	t <sub>KCY2</sub>	4.0 V ≤ EV <sub>DD</sub> ≤ 5.5 V	20 MHz < f <sub>MCK</sub>	8/f <sub>MCK</sub>		–		–		–		ns	
			f <sub>MCK</sub> ≤ 20 MHz	6/f <sub>MCK</sub>		6/f <sub>MCK</sub>		6/f <sub>MCK</sub>		6/f <sub>MCK</sub>		ns	
		2.7 V ≤ EV <sub>DD</sub> ≤ 5.5 V	16 MHz < f <sub>MCK</sub>	8/f <sub>MCK</sub>		–		–		–		ns	
			f <sub>MCK</sub> ≤ 16 MHz	6/f <sub>MCK</sub>		6/f <sub>MCK</sub>		6/f <sub>MCK</sub>		6/f <sub>MCK</sub>		ns	
		2.4 V ≤ EV <sub>DD</sub> ≤ 5.5 V			6/f <sub>MCK</sub> and 500		6/f <sub>MCK</sub> and 500		6/f <sub>MCK</sub> and 500		6/f <sub>MCK</sub> and 500		ns
		1.9 V ≤ EV <sub>DD</sub> ≤ 5.5 V			6/f <sub>MCK</sub> and 750		6/f <sub>MCK</sub> and 750		6/f <sub>MCK</sub> and 750		6/f <sub>MCK</sub> and 750		ns
		1.8 V ≤ EV <sub>DD</sub> ≤ 5.5 V			6/f <sub>MCK</sub> and 1500		6/f <sub>MCK</sub> and 1500		6/f <sub>MCK</sub> and 1500		6/f <sub>MCK</sub> and 1500		ns
		1.7 V ≤ EV <sub>DD</sub> ≤ 5.5 V					6/f <sub>MCK</sub> and 1500		6/f <sub>MCK</sub> and 1500		6/f <sub>MCK</sub> and 1500		ns
SCKp high-/low-level width	t <sub>KH2</sub> , t <sub>KL2</sub>	4.0 V ≤ EV <sub>DD</sub> ≤ 5.5 V		t <sub>KCY2</sub> / 2 – 7		t <sub>KCY2</sub> / 2 – 7		t <sub>KCY2</sub> / 2 – 7		t <sub>KCY2</sub> / 2 – 7		ns	
		2.7 V ≤ EV <sub>DD</sub> ≤ 5.5 V		t <sub>KCY2</sub> / 2 – 8		t <sub>KCY2</sub> / 2 – 8		t <sub>KCY2</sub> / 2 – 8		t <sub>KCY2</sub> / 2 – 8		ns	
		1.9 V ≤ EV <sub>DD</sub> ≤ 5.5 V		t <sub>KCY2</sub> / 2 – 18		t <sub>KCY2</sub> / 2 – 18		t <sub>KCY2</sub> / 2 – 18		t <sub>KCY2</sub> / 2 – 18		ns	
		1.8 V ≤ EV <sub>DD</sub> ≤ 5.5 V		t <sub>KCY2</sub> / 2 – 66		t <sub>KCY2</sub> / 2 – 66		t <sub>KCY2</sub> / 2 – 66		t <sub>KCY2</sub> / 2 – 66		ns	
		1.7 V ≤ EV <sub>DD</sub> ≤ 5.5 V				t <sub>KCY2</sub> / 2 – 66		t <sub>KCY2</sub> / 2 – 66		t <sub>KCY2</sub> / 2 – 66		ns	
Slp setup time (to SCKp↑) <sup>Note 1</sup>	t <sub>SIK2</sub>	2.7 V ≤ EV <sub>DD</sub> ≤ 5.5 V		1/f <sub>MCK</sub> +20		1/f <sub>MCK</sub> +30		1/f <sub>MCK</sub> +30		1/f <sub>MCK</sub> +30		ns	
		1.9 V ≤ EV <sub>DD</sub> ≤ 5.5 V		1/f <sub>MCK</sub> +30		1/f <sub>MCK</sub> +30		1/f <sub>MCK</sub> +30		1/f <sub>MCK</sub> +30		ns	
		1.8 V ≤ EV <sub>DD</sub> ≤ 5.5 V		1/f <sub>MCK</sub> +40		1/f <sub>MCK</sub> +40		1/f <sub>MCK</sub> +40		1/f <sub>MCK</sub> +40		ns	
		1.7 V ≤ EV <sub>DD</sub> ≤ 5.5 V				1/f <sub>MCK</sub> +40		1/f <sub>MCK</sub> +40		1/f <sub>MCK</sub> +40		ns	
Slp hold time (from SCKp↑) <sup>Note 1</sup>	t <sub>SI2</sub>	2.1 V ≤ EV <sub>DD</sub> ≤ 5.5 V		1/f <sub>MCK</sub> +31		1/f <sub>MCK</sub> +31		1/f <sub>MCK</sub> +31		1/f <sub>MCK</sub> +31		ns	
		1.9 V ≤ EV <sub>DD</sub> ≤ 5.5 V				1/f <sub>MCK</sub> +31		1/f <sub>MCK</sub> +31		1/f <sub>MCK</sub> +31		ns	
		1.7 V ≤ EV <sub>DD</sub> ≤ 5.5 V								1/f <sub>MCK</sub> +250		ns	
Delay time from SCKp↓ to SOp output <sup>Note 2</sup>	t <sub>KS02</sub>	C = 30 pF <sup>Note 3</sup>	2.7 V ≤ EV <sub>DD</sub> ≤ 5.5 V		2/f <sub>MCK</sub> + 44		2/f <sub>MCK</sub> + 110		2/f <sub>MCK</sub> + 110		2/f <sub>MCK</sub> + 110	ns	
			2.4 V ≤ EV <sub>DD</sub> ≤ 5.5 V		2/f <sub>MCK</sub> + 75		2/f <sub>MCK</sub> + 110		2/f <sub>MCK</sub> + 110		2/f <sub>MCK</sub> + 110	ns	
			1.9 V ≤ EV <sub>DD</sub> ≤ 5.5 V		2/f <sub>MCK</sub> + 100		2/f <sub>MCK</sub> + 110		2/f <sub>MCK</sub> + 110		2/f <sub>MCK</sub> + 110	ns	
			1.8 V ≤ EV <sub>DD</sub> ≤ 5.5 V		2/f <sub>MCK</sub> + 220		2/f <sub>MCK</sub> + 220		2/f <sub>MCK</sub> + 220		2/f <sub>MCK</sub> + 220	ns	
			1.7 V ≤ EV <sub>DD</sub> ≤ 5.5 V				2/f <sub>MCK</sub> + 220		2/f <sub>MCK</sub> + 220		2/f <sub>MCK</sub> + 220	ns	

(Notes, Caution, and Remarks are listed on the next page.)

- Notes**
1. When  $DAP_{mn} = 0$  and  $CKP_{mn} = 0$ , or  $DAP_{mn} = 1$  and  $CKP_{mn} = 1$ . The  $S_{lp}$  setup time becomes “to  $SCK_{p\downarrow}$ ” when  $DAP_{mn} = 0$  and  $CKP_{mn} = 1$ , or  $DAP_{mn} = 1$  and  $CKP_{mn} = 0$ .
  2. When  $DAP_{mn} = 0$  and  $CKP_{mn} = 0$ , or  $DAP_{mn} = 1$  and  $CKP_{mn} = 1$ . The  $S_{lp}$  hold time becomes “from  $SCK_{p\uparrow}$ ” when  $DAP_{mn} = 0$  and  $CKP_{mn} = 1$ , or  $DAP_{mn} = 1$  and  $CKP_{mn} = 0$ .
  3.  $C$  is the load capacitance of the  $S_{Op}$  output lines.
  4. Transfer rate in the SNOOZE mode: MAX. 1 Mbps
  5. Either  $V_{DD}$  or  $V_{BAT}$  is selected by the battery backup function.

**Caution** Select the normal input buffer for the  $S_{lp}$  pin and  $SCK_{p}$  pin and the normal output mode for the  $S_{Op}$  pin by using port input mode register  $g$  ( $PIM_g$ ) and port output mode register  $g$  ( $POM_g$ ).

- Remarks**
1.  $p$ : CSI number ( $p = 00, 10, 30$ ),  $m$ : Unit number ( $m = 0$ ),  $n$ : Channel number ( $n = 0$ ),  
 $g$ : PIM number ( $g = 0, 1, 8$ )
  2.  $f_{MCK}$ : Serial array unit operation clock frequency  
(Operating clock that is set with the serial clock select register  $m$  ( $SPS_m$ ) and the  $CKS_{mn}$  bit of serial mode register  $mn$  ( $SMR_{mn}$ ).  
 $m$ : Unit number,  $n$ : Channel number ( $mn = 00, 10, 30$ ))

**Simplified SPI (CSI) mode connection diagram (during communication at same potential)**

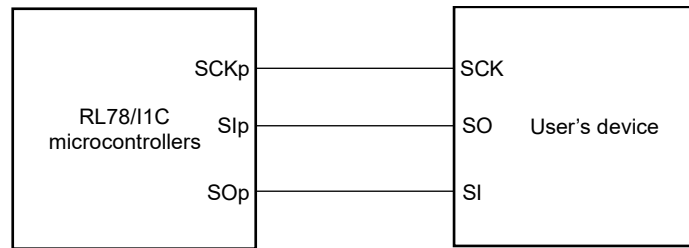

**Simplified SPI (CSI) mode serial transfer timing (during communication at same potential)  
(when DAPmn = 0 and CKPmn = 0, or DAPmn = 1 and CKPmn = 1)**

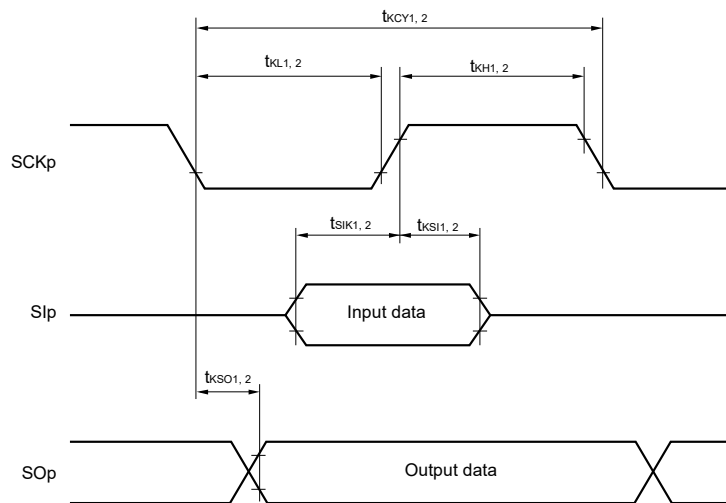

**Simplified SPI (CSI) mode serial transfer timing (during communication at same potential)  
(when DAPmn = 0 and CKPmn = 1, or DAPmn = 1 and CKPmn = 0)**

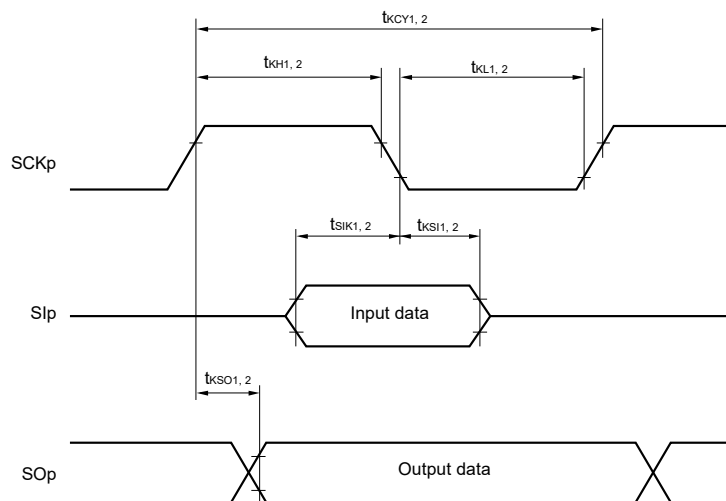

- Remarks**
1. p: CSI number (p = 00, 10, 30)
  2. m: Unit number, n: Channel number (mn = 00, 10, 30)

(4) During communication at same potential (simplified I<sup>2</sup>C mode)(T<sub>A</sub> = -40 to +85°C, 1.7 V ≤ EV<sub>DD0</sub> = EV<sub>DD1</sub> ≤ V<sub>DD</sub><sup>Note 3</sup> ≤ 5.5 V, V<sub>SS</sub> = EV<sub>SS0</sub> = EV<sub>SS1</sub> = 0 V)

(1/2)

Parameter	Symbol	Conditions	HS (high-speed main) Mode		LS (low-speed main) Mode		LP (low-power main) Mode		LV (low-voltage main) Mode		Unit
			MIN.	MAX.	MIN.	MAX.	MIN.	MAX.	MIN.	MAX.	
SCLr clock frequency	f <sub>SCL</sub>	2.7 V ≤ EV <sub>DD</sub> ≤ 5.5 V, C <sub>b</sub> = 50 pF, R <sub>b</sub> = 2.7 kΩ		1000 <sup>Note 1</sup>		400 <sup>Note 1</sup>		400 <sup>Note 1</sup>		400 <sup>Note 1</sup>	kHz
		1.9 V ≤ EV <sub>DD</sub> ≤ 5.5 V, C <sub>b</sub> = 100 pF, R <sub>b</sub> = 3 kΩ		400 <sup>Note 1</sup>		400 <sup>Note 1</sup>		400 <sup>Note 1</sup>		400 <sup>Note 1</sup>	
		1.9 V ≤ EV <sub>DD</sub> < 2.7 V, C <sub>b</sub> = 100 pF, R <sub>b</sub> = 5 kΩ		300 <sup>Note 1</sup>		300 <sup>Note 1</sup>		300 <sup>Note 1</sup>		300 <sup>Note 1</sup>	
		1.8 V ≤ EV <sub>DD</sub> < 1.9 V, C <sub>b</sub> = 100 pF, R <sub>b</sub> = 5 kΩ		250 <sup>Note 1</sup>		250 <sup>Note 1</sup>		250 <sup>Note 1</sup>		250 <sup>Note 1</sup>	
		1.7 V ≤ EV <sub>DD</sub> < 1.9 V, C <sub>b</sub> = 100 pF, R <sub>b</sub> = 5 kΩ				250 <sup>Note 1</sup>		250 <sup>Note 1</sup>		250 <sup>Note 1</sup>	
Hold time when SCLr = "L"	t <sub>LOW</sub>	2.7 V ≤ EV <sub>DD</sub> ≤ 5.5 V, C <sub>b</sub> = 50 pF, R <sub>b</sub> = 2.7 kΩ	475		1150		1150		1150		ns
		1.9 V ≤ EV <sub>DD</sub> ≤ 5.5 V, C <sub>b</sub> = 100 pF, R <sub>b</sub> = 3 kΩ	1150		1150		1150		1150		
		1.9 V ≤ EV <sub>DD</sub> < 2.7 V, C <sub>b</sub> = 100 pF, R <sub>b</sub> = 5 kΩ	1550		1550		1550		1550		
		1.8 V ≤ EV <sub>DD</sub> < 1.9 V, C <sub>b</sub> = 100 pF, R <sub>b</sub> = 5 kΩ	1850		1850		1850		1850		
		1.7 V ≤ EV <sub>DD</sub> < 1.9 V, C <sub>b</sub> = 100 pF, R <sub>b</sub> = 5 kΩ			1850		1850		1850		
Hold time when SCLr = "H"	t <sub>HIGH</sub>	2.7 V ≤ EV <sub>DD</sub> ≤ 5.5 V, C <sub>b</sub> = 50 pF, R <sub>b</sub> = 2.7 kΩ	475		1150		1150		1150		ns
		1.9 V ≤ EV <sub>DD</sub> ≤ 5.5 V, C <sub>b</sub> = 100 pF, R <sub>b</sub> = 3 kΩ	1150		1150		1150		1150		
		1.9 V ≤ EV <sub>DD</sub> < 2.7 V, C <sub>b</sub> = 100 pF, R <sub>b</sub> = 5 kΩ	1550		1550		1550		1550		
		1.8 V ≤ EV <sub>DD</sub> < 1.9 V, C <sub>b</sub> = 100 pF, R <sub>b</sub> = 5 kΩ	1850		1850		1850		1850		
		1.7 V ≤ EV <sub>DD</sub> < 1.9 V, C <sub>b</sub> = 100 pF, R <sub>b</sub> = 5 kΩ			1850		1850		1850		
Data setup time (reception)	t <sub>SU:DAT</sub>	2.7 V ≤ EV <sub>DD</sub> ≤ 5.5 V, C <sub>b</sub> = 50 pF, R <sub>b</sub> = 2.7 kΩ	1/f <sub>MCK</sub> + 85 <sup>Notes 1,2</sup>		1/f <sub>MCK</sub> + 145 <sup>Notes 1,2</sup>		1/f <sub>MCK</sub> + 145 <sup>Notes 1,2</sup>		1/f <sub>MCK</sub> + 145 <sup>Notes 1,2</sup>		ns
		1.9 V ≤ EV <sub>DD</sub> ≤ 5.5 V, C <sub>b</sub> = 100 pF, R <sub>b</sub> = 3 kΩ	1/f <sub>MCK</sub> + 145 <sup>Notes 1,2</sup>		1/f <sub>MCK</sub> + 145 <sup>Notes 1,2</sup>		1/f <sub>MCK</sub> + 145 <sup>Notes 1,2</sup>		1/f <sub>MCK</sub> + 145 <sup>Notes 1,2</sup>		
		1.9 V ≤ EV <sub>DD</sub> < 2.7 V, C <sub>b</sub> = 100 pF, R <sub>b</sub> = 5 kΩ	1/f <sub>MCK</sub> + 230 <sup>Notes 1,2</sup>		1/f <sub>MCK</sub> + 230 <sup>Notes 1,2</sup>		1/f <sub>MCK</sub> + 230 <sup>Notes 1,2</sup>		1/f <sub>MCK</sub> + 230 <sup>Notes 1,2</sup>		
		1.8 V ≤ EV <sub>DD</sub> < 1.9 V, C <sub>b</sub> = 100 pF, R <sub>b</sub> = 5 kΩ	1/f <sub>MCK</sub> + 290 <sup>Notes 1,2</sup>		1/f <sub>MCK</sub> + 290 <sup>Notes 1,2</sup>		1/f <sub>MCK</sub> + 290 <sup>Notes 1,2</sup>		1/f <sub>MCK</sub> + 290 <sup>Notes 1,2</sup>		
		1.7 V ≤ EV <sub>DD</sub> < 1.9 V, C <sub>b</sub> = 100 pF, R <sub>b</sub> = 5 kΩ			1/f <sub>MCK</sub> + 290 <sup>Notes 1,2</sup>		1/f <sub>MCK</sub> + 290 <sup>Notes 1,2</sup>		1/f <sub>MCK</sub> + 290 <sup>Notes 1,2</sup>		

(Notes, Caution, and Remarks are listed on the next page.)

( $T_A = -40$  to  $+85^\circ\text{C}$ ,  $1.7\text{ V} \leq EV_{DD0} = EV_{DD1} \leq V_{DD}^{\text{Note 3}} \leq 5.5\text{ V}$ ,  $V_{SS} = EV_{SS0} = EV_{SS1} = 0\text{ V}$ )

(2/2)

Parameter	Symbol	Conditions	HS (high-speed main) Mode		LS (low-speed main) Mode		LP (low-power main) Mode		LV (low-voltage main) Mode		Unit
			MIN.	MAX.	MIN.	MAX.	MIN.	MAX.	MIN.	MAX.	
Data hold time (transmission)	$t_{HD,DAT}$	$2.7\text{ V} \leq EV_{DD} \leq 5.5\text{ V}$ , $C_b = 50\text{ pF}$ , $R_b = 2.7\text{ k}\Omega$	0	305	0	305	0	305	0	305	ns
		$1.9\text{ V} \leq EV_{DD} \leq 5.5\text{ V}$ , $C_b = 100\text{ pF}$ , $R_b = 3\text{ k}\Omega$	0	355	0	355	0	355	0	355	ns
		$1.9\text{ V} \leq EV_{DD} < 2.7\text{ V}$ , $C_b = 100\text{ pF}$ , $R_b = 5\text{ k}\Omega$	0	405	0	405	0	405	0	405	ns
		$1.8\text{ V} \leq EV_{DD} < 1.9\text{ V}$ , $C_b = 100\text{ pF}$ , $R_b = 5\text{ k}\Omega$	0	405	0	405	0	405	0	405	ns
		$1.7\text{ V} \leq EV_{DD} < 1.9\text{ V}$ , $C_b = 100\text{ pF}$ , $R_b = 5\text{ k}\Omega$			0	405	0	405	0	405	ns

- Notes**
- The value must also be equal to or less than  $f_{MCK}/4$ .
  - Set the  $f_{MCK}$  value to keep the hold time of  $SCLr = "L"$  and  $SCLr = "H"$ .
  - Either  $V_{DD}$  or  $V_{BAT}$  is selected by the battery backup function.

**Simplified I<sup>2</sup>C mode connection diagram (during communication at same potential)**

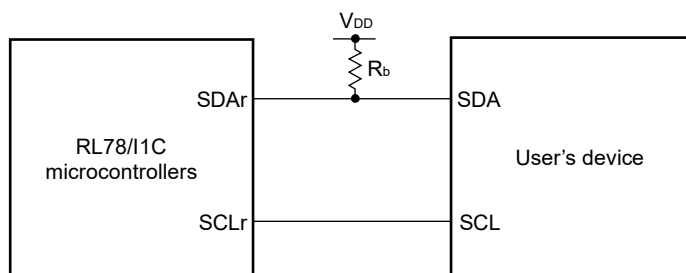

**Simplified I<sup>2</sup>C mode serial transfer timing (during communication at same potential)**

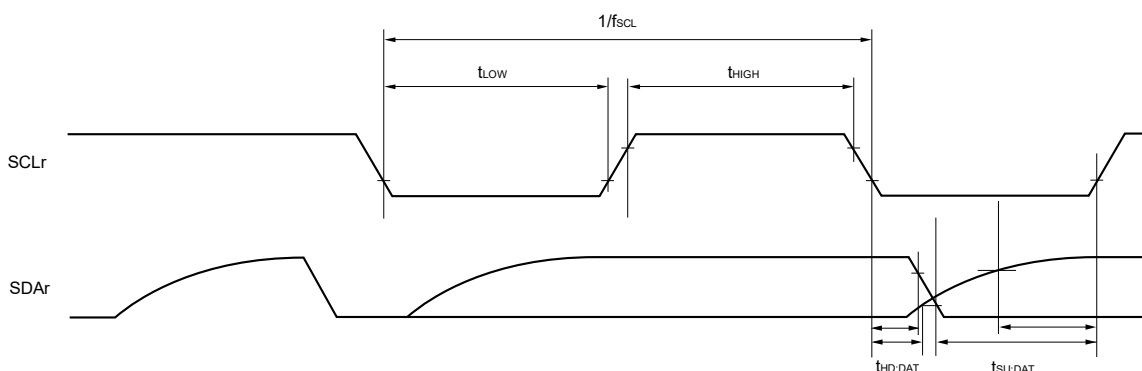

**Caution** Select the normal input buffer and the N-ch open drain output ( $V_{DD}$  tolerance) mode for the  $SDAr$  pin and the normal output mode for the  $SCLr$  pin by using port input mode register g (PIMg) and port output mode register g (POMg).

- Remarks**
- $R_b[\Omega]$ : Communication line ( $SDAr$ ) pull-up resistance,  $C_b[F]$ : Communication line ( $SDAr$ ,  $SCLr$ ) load capacitance
  - r: IIC number (r = 00, 10, 30), g: PIM and POM number (g = 0, 1, 8)
  - $f_{MCK}$ : Serial array unit operation clock frequency  
(Operating clock that is set with the serial clock select register m (SPSm) and the CKSmn bit of serial mode register mn (SMRmn).  
m: Unit number (m = 0, 1), n: Channel number (n = 0, 2), mn = 00, 02, 12))



**(5) Communication at different potential (1.9 V, 2.5 V, 3 V) (UART mode) (1/2)****( $T_A = -40$  to  $+85^\circ\text{C}$ ,  $1.9\text{ V} \leq \text{EV}_{\text{DD}0} = \text{EV}_{\text{DD}1} \leq \text{V}_{\text{DD}}^{\text{Note 1}} \leq 5.5\text{ V}$ ,  $\text{V}_{\text{SS}} = \text{EV}_{\text{SS}0} = \text{EV}_{\text{SS}1} = 0\text{ V}$ )**

Parameter	Symbol	Conditions	HS (high-speed main) Mode		LS (low-speed main) Mode		LP (low-power main) Mode		LV (low-voltage main) Mode		Unit			
			MIN.	MAX.	MIN.	MAX.	MIN.	MAX.	MIN.	MAX.				
Transfer rate		Reception	$4.0\text{ V} \leq \text{EV}_{\text{DD}} \leq 5.5\text{ V}$ , $2.7\text{ V} \leq \text{V}_b \leq 4.0\text{ V}$		$f_{\text{MCK}}/6^{\text{Note 1}}$		$f_{\text{MCK}}/6^{\text{Note 1}}$		$f_{\text{MCK}}/6^{\text{Note 1}}$		$f_{\text{MCK}}/6^{\text{Note 1}}$	bps		
				Theoretical value of the maximum transfer rate $f_{\text{MCK}} = f_{\text{CLK}}^{\text{Note 4}}$		5.3		1.3		0.1		0.6	Mbps	
			$2.7\text{ V} \leq \text{EV}_{\text{DD}} < 4.0\text{ V}$ , $2.3\text{ V} \leq \text{V}_b \leq 2.7\text{ V}$		$f_{\text{MCK}}/6^{\text{Note 1}}$		$f_{\text{MCK}}/6^{\text{Note 1}}$		$f_{\text{MCK}}/6^{\text{Note 1}}$		$f_{\text{MCK}}/6^{\text{Note 1}}$		$f_{\text{MCK}}/6^{\text{Note 1}}$	bps
				Theoretical value of the maximum transfer rate $f_{\text{MCK}} = f_{\text{CLK}}^{\text{Note 4}}$		5.3		1.3		0.1		0.6	Mbps	
			$1.9\text{ V} \leq \text{EV}_{\text{DD}} < 3.3\text{ V}$ , $1.8\text{ V} \leq \text{V}_b \leq 2.0\text{ V}$		$f_{\text{MCK}}/6$ Notes 1 to 3		$f_{\text{MCK}}/6$ Notes 1, 2		$f_{\text{MCK}}/6$ Notes 1, 2		$f_{\text{MCK}}/6$ Notes 1, 2		$f_{\text{MCK}}/6$ Notes 1, 2	bps
				Theoretical value of the maximum transfer rate $f_{\text{MCK}} = f_{\text{CLK}}^{\text{Note 4}}$		5.3		1.3		0.1		0.6	Mbps	

**Notes 1.** Transfer rate in the SNOOZE mode is 4800 bps only.**2.** Use it with  $\text{EV}_{\text{DD}} \geq \text{V}_b$ .**3.** The following conditions are required for low voltage interface. $2.4\text{ V} \leq \text{EV}_{\text{DD}} < 2.7\text{ V}$ : MAX. 2.6 Mbps $1.9\text{ V} \leq \text{EV}_{\text{DD}} < 2.4\text{ V}$ : MAX. 1.3 Mbps**4.** The maximum operating frequencies of the CPU/peripheral hardware clock ( $f_{\text{CLK}}$ ) are:

HS (high-speed main) mode: 32 MHz ( $2.8\text{ V} \leq \text{EV}_{\text{DD}} \leq 5.5\text{ V}$ ), 24 MHz ( $2.7\text{ V} \leq \text{EV}_{\text{DD}} \leq 5.5\text{ V}$ ),  
16 MHz ( $2.5\text{ V} \leq \text{EV}_{\text{DD}} \leq 5.5\text{ V}$ ), 12 MHz ( $2.4\text{ V} \leq \text{EV}_{\text{DD}} \leq 5.5\text{ V}$ ),  
6 MHz ( $2.1\text{ V} \leq \text{EV}_{\text{DD}} \leq 5.5\text{ V}$ ),

LS (low-speed main) mode: 8 MHz ( $1.9\text{ V} \leq \text{EV}_{\text{DD}} \leq 5.5\text{ V}$ ), 4 MHz ( $1.9\text{ V} \leq \text{EV}_{\text{DD}} \leq 5.5\text{ V}$ )

LP (low-power main) mode: 1 MHz ( $1.9\text{ V} \leq \text{EV}_{\text{DD}} \leq 5.5\text{ V}$ )

LV (low-voltage main) mode: 4 MHz ( $1.7\text{ V} \leq \text{EV}_{\text{DD}} \leq 5.5\text{ V}$ )

**Caution** Select the TTL input buffer for the RxDq pin and the N-ch open drain output ( $\text{V}_{\text{DD}}$  tolerance) mode for the TxDq pin by using port input mode register g (PIMg) and port output mode register g (POMg). For  $\text{V}_{\text{IH}}$  and  $\text{V}_{\text{IL}}$ , see the DC characteristics with TTL input buffer selected.

**Remarks 1.**  $\text{V}_b[\text{V}]$ : Communication line voltage**2.** q: UART number (q = 0 to 3), g: PIM and POM number (g = 0, 1, 3, 5, 8)**3.**  $f_{\text{MCK}}$ : Serial array unit operation clock frequency

(Operating clock that is set with the serial clock select register m (SPSm) and the CKSmn bit of serial mode register mn (SMRmn).

m: Unit number, n: Channel number (mn = 00 to 03, 10 to 13))

**(5) Communication at different potential (1.8 V, 2.5 V, 3 V) (UART mode) (2/2)**

(T<sub>A</sub> = -40 to +85°C, 1.9 V ≤ EV<sub>DD0</sub> = EV<sub>DD1</sub> ≤ V<sub>DD</sub><sup>Note 10</sup> ≤ 5.5 V, V<sub>SS</sub> = EV<sub>SS0</sub> = EV<sub>SS1</sub> = 0 V)

Parameter	Symbol	Conditions	HS (high-speed main) Mode		LS (low-speed main) Mode		LP (low-power main) Mode		LV (low-voltage main) Mode		Unit
			MIN.	MAX.	MIN.	MAX.	MIN.	MAX.	MIN.	MAX.	
Transfer rate	Transmission	4.0 V ≤ EV <sub>DD</sub> ≤ 5.5 V, 2.7 V ≤ V <sub>b</sub> ≤ 4.0 V		Notes 1, 2		Notes 1, 2		Notes 1, 2		Notes 1, 2	bps
		Theoretical value of the maximum transfer rate <sup>Note 9</sup> C <sub>b</sub> = 50 pF, R <sub>b</sub> = 1.4 kΩ, V <sub>b</sub> = 2.7 V		2.8 <sup>Note 3</sup>		2.8 <sup>Note 3</sup>		2.8 <sup>Note 3</sup>		2.8 <sup>Note 3</sup>	Mbps
		2.7 V ≤ EV <sub>DD</sub> < 4.0 V, 2.3 V ≤ V <sub>b</sub> ≤ 2.7 V		Notes 2, 4		Notes 2, 4		Notes 2, 4		Notes 2, 4	bps
		Theoretical value of the maximum transfer rate <sup>Note 9</sup> C <sub>b</sub> = 50 pF, R <sub>b</sub> = 2.7 kΩ, V <sub>b</sub> = 2.3 V		1.2 <sup>Note 5</sup>		1.2 <sup>Note 5</sup>		1.2 <sup>Note 5</sup>		1.2 <sup>Note 5</sup>	Mbps
		1.9 V ≤ EV <sub>DD</sub> < 3.3 V, 1.6 V ≤ V <sub>b</sub> ≤ 2.0 V		Notes 2, 6, 7		Notes 2, 6, 7		Notes 2, 6, 7		Notes 2, 6, 7	bps
		Theoretical value of the maximum transfer rate <sup>Note 9</sup> C <sub>b</sub> = 50 pF, R <sub>b</sub> = 5.5 kΩ, V <sub>b</sub> = 1.6 V		0.43 <sup>Note 8</sup>		0.43 <sup>Note 8</sup>		0.43 <sup>Note 8</sup>		0.43 <sup>Note 8</sup>	Mbps

**Notes 1.** The smaller maximum transfer rate derived by using f<sub>MCK</sub>/6 or the following expression is the valid maximum transfer rate.

Expression for calculating the transfer rate when 4.0 V ≤ EV<sub>DD</sub> ≤ 5.5 V and 2.7 V ≤ V<sub>b</sub> ≤ 4.0 V

$$\text{Maximum transfer rate} = \frac{1}{\{-C_b \times R_b \times \ln(1 - \frac{2.2}{V_b})\} \times 3} \text{ [bps]}$$

$$\text{Baud rate error (theoretical value)} = \frac{\frac{1}{\text{Transfer rate} \times 2} - \{-C_b \times R_b \times \ln(1 - \frac{2.2}{V_b})\}}{(\frac{1}{\text{Transfer rate}}) \times \text{Number of transferred bits}} \times 100 \text{ [%]}$$

\* This value is the theoretical value of the relative difference between the transmission and reception sides.

- Transfer rate in the SNOOZE mode is 4800 bps only.
- This value as an example is calculated when the conditions described in the “Conditions” column are met. Refer to **Note 1** above to calculate the maximum transfer rate under conditions of the customer.
- The smaller maximum transfer rate derived by using f<sub>MCK</sub>/6 or the following expression is the valid maximum transfer rate.

Expression for calculating the transfer rate when 2.7 V ≤ EV<sub>DD</sub> < 4.0 V and 2.3 V ≤ V<sub>b</sub> ≤ 2.7 V

$$\text{Maximum transfer rate} = \frac{1}{\{-C_b \times R_b \times \ln(1 - \frac{2.0}{V_b})\} \times 3} \text{ [bps]}$$

$$\text{Baud rate error (theoretical value)} = \frac{\frac{1}{\text{Transfer rate} \times 2} - \{-C_b \times R_b \times \ln(1 - \frac{2.0}{V_b})\}}{(\frac{1}{\text{Transfer rate}}) \times \text{Number of transferred bits}} \times 100 \text{ [%]}$$

\* This value is the theoretical value of the relative difference between the transmission and reception sides.

**Notes 5.** This value as an example is calculated when the conditions described in the “Conditions” column are met. Refer to **Note 4** above to calculate the maximum transfer rate under conditions of the customer.

**6.** Use it with  $EV_{DD} \geq V_b$ .

**7.** The smaller maximum transfer rate derived by using  $f_{MCK}/6$  or the following expression is the valid maximum transfer rate.

Expression for calculating the transfer rate when  $1.9\text{ V} \leq EV_{DD} < 2.7\text{ V}$  and  $1.6\text{ V} \leq V_b \leq 2.0\text{ V}$

$$\text{Maximum transfer rate} = \frac{1}{\{-C_b \times R_b \times \ln(1 - \frac{1.5}{V_b})\} \times 3} \text{ [bps]}$$

$$\text{Baud rate error (theoretical value)} = \frac{\frac{1}{\text{Transfer rate} \times 2} - \{-C_b \times R_b \times \ln(1 - \frac{1.5}{V_b})\}}{(\frac{1}{\text{Transfer rate}}) \times \text{Number of transferred bits}} \times 100 \text{ [%]}$$

\* This value is the theoretical value of the relative difference between the transmission and reception sides.

**8.** This value as an example is calculated when the conditions described in the “Conditions” column are met. Refer to **Note 7** above to calculate the maximum transfer rate under conditions of the customer.

**9.** The maximum operating frequencies of the CPU/peripheral hardware clock (fCLK) are:

HS (high-speed main) mode: 32 MHz ( $2.8\text{ V} \leq EV_{DD} \leq 5.5\text{ V}$ ), 24 MHz ( $2.7\text{ V} \leq EV_{DD} \leq 5.5\text{ V}$ ),  
 16 MHz ( $2.5\text{ V} \leq EV_{DD} \leq 5.5\text{ V}$ ), 12 MHz ( $2.4\text{ V} \leq EV_{DD} \leq 5.5\text{ V}$ ),  
 6 MHz ( $2.1\text{ V} \leq EV_{DD} \leq 5.5\text{ V}$ ),

LS (low-speed main) mode: 8 MHz ( $1.9\text{ V} \leq EV_{DD} \leq 5.5\text{ V}$ ), 4 MHz ( $1.9\text{ V} \leq EV_{DD} \leq 5.5\text{ V}$ )

LP (low-power main) mode: 1 MHz ( $1.9\text{ V} \leq EV_{DD} \leq 5.5\text{ V}$ )

LV (low-voltage main) mode: 4 MHz ( $1.7\text{ V} \leq EV_{DD} \leq 5.5\text{ V}$ )

**10.** Either  $V_{DD}$  or  $V_{BAT}$  is selected by the battery backup function.

**Caution** Select the TTL input buffer for the RxDq pin and the N-ch open drain output ( $V_{DD}$  tolerance) mode for the TxDq pin by using port input mode register g (PIMg) and port output mode register g (POMg). For  $V_{IH}$  and  $V_{IL}$ , see the DC characteristics with TTL input buffer selected.

- Remarks 1.**  $R_b[\Omega]$ : Communication line (TxDq) pull-up resistance,  
 $C_b[F]$ : Communication line (TxDq) load capacitance,  $V_b[V]$ : Communication line voltage
- 2.** q: UART number (q = 0 to 3), g: PIM and POM number (g = 0, 1, 3, 5, 8)
- 3.**  $f_{MCK}$ : Serial array unit operation clock frequency  
 (Operating clock that is set with the serial clock select register m (SPSm) and the CKSmn bit of serial mode register mn (SMRmn).  
 m: Unit number, n: Channel number (mn = 00 to 03, 10 to 13))

**UART mode connection diagram (during communication at different potential)**

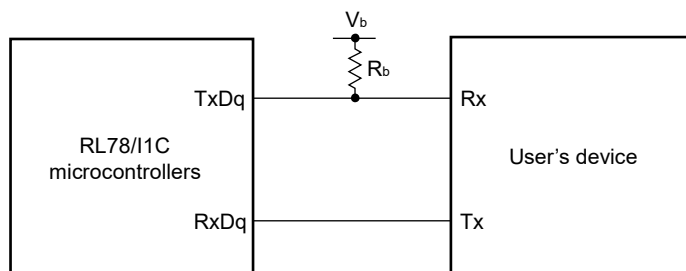

UART mode bit width (during communication at different potential) (reference)

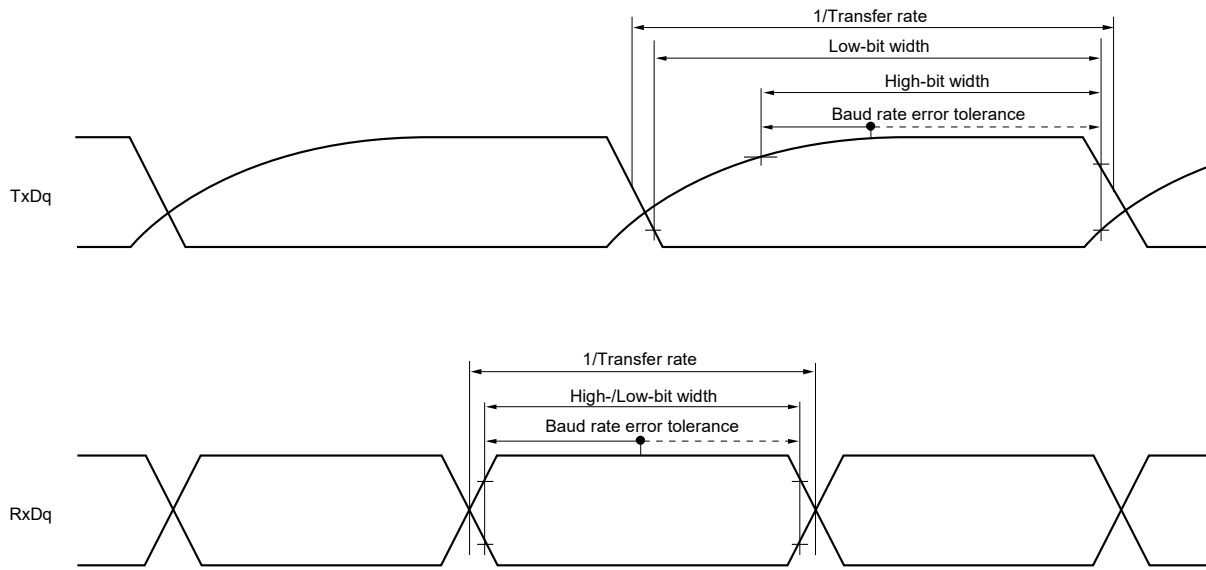

**Caution** Select the TTL input buffer for the RxDq pin and the N-ch open drain output ( $V_{DD}$  tolerance) mode for the TxDq pin by using port input mode register g (PIMg) and port output mode register g (POMg). For  $V_{IH}$  and  $V_{IL}$ , see the DC characteristics with TTL input buffer selected.

- Remarks**
1.  $R_b[\Omega]$ : Communication line (TxDq) pull-up resistance,  $V_b[V]$ : Communication line voltage
  2. q: UART number (q = 0 to 3), g: PIM and POM number (g = 0, 1, 3, 5, 8)

**(6) Communication at different potential (2.5 V, 3 V) ( $f_{MCK}/2$ ) (Simplified SPI (CSI) mode) (master mode, SCKp... internal clock output, corresponding CSI00 only) (1/2)**

( $T_A = -40$  to  $+85^\circ\text{C}$ ,  $2.7\text{ V} \leq EV_{DD0} = EV_{DD1} \leq V_{DD}^{\text{Note 3}} \leq 5.5\text{ V}$ ,  $V_{SS} = EV_{SS0} = EV_{SS1} = 0\text{ V}$ )

Parameter	Symbol	Conditions	HS (high-speed main) Mode		LS (low-speed main) Mode		LP (low-power main) Mode		LV (low-voltage main) Mode		Unit
			MIN.	MAX.	MIN.	MAX.	MIN.	MAX.	MIN.	MAX.	
SCKp cycle time	$t_{KCY1}$	$t_{KCY1} \geq 2/f_{CLK}$ $4.0\text{ V} \leq EV_{DD} \leq 5.5\text{ V}$ , $2.7\text{ V} \leq V_b \leq 4.0\text{ V}$ , $C_b = 20\text{ pF}$ , $R_b = 1.4\text{ k}\Omega$	200		1150		1150		1150		ns
		$2.7\text{ V} \leq EV_{DD} < 4.0\text{ V}$ , $2.3\text{ V} \leq V_b \leq 2.7\text{ V}$ , $C_b = 20\text{ pF}$ , $R_b = 2.7\text{ k}\Omega$	300		1150		1150		1150		ns
SCKp high-level width	$t_{KH1}$	$4.0\text{ V} \leq EV_{DD} \leq 5.5\text{ V}$ , $2.7\text{ V} \leq V_b \leq 4.0\text{ V}$ , $C_b = 20\text{ pF}$ , $R_b = 1.4\text{ k}\Omega$	$t_{KCY1}/2 - 50$		$t_{KCY1}/2 - 50$		$t_{KCY1}/2 - 50$		$t_{KCY1}/2 - 50$		ns
		$2.7\text{ V} \leq EV_{DD} < 4.0\text{ V}$ , $2.3\text{ V} \leq V_b \leq 2.7\text{ V}$ , $C_b = 20\text{ pF}$ , $R_b = 2.7\text{ k}\Omega$	$t_{KCY1}/2 - 120$		$t_{KCY1}/2 - 120$		$t_{KCY1}/2 - 120$		$t_{KCY1}/2 - 120$		ns
SCKp low-level width	$t_{KL1}$	$4.0\text{ V} \leq EV_{DD} \leq 5.5\text{ V}$ , $2.7\text{ V} \leq V_b \leq 4.0\text{ V}$ , $C_b = 20\text{ pF}$ , $R_b = 1.4\text{ k}\Omega$	$t_{KCY1}/2 - 7$		$t_{KCY1}/2 - 50$		$t_{KCY1}/2 - 50$		$t_{KCY1}/2 - 50$		ns
		$2.7\text{ V} \leq EV_{DD} < 4.0\text{ V}$ , $2.3\text{ V} \leq V_b \leq 2.7\text{ V}$ , $C_b = 20\text{ pF}$ , $R_b = 2.7\text{ k}\Omega$	$t_{KCY1}/2 - 10$		$t_{KCY1}/2 - 50$		$t_{KCY1}/2 - 50$		$t_{KCY1}/2 - 50$		ns
Slp setup time (to SCKp $\uparrow$ ) <sup>Note 1</sup>	$t_{SIK1}$	$4.0\text{ V} \leq EV_{DD} \leq 5.5\text{ V}$ , $2.7\text{ V} \leq V_b \leq 4.0\text{ V}$ , $C_b = 20\text{ pF}$ , $R_b = 1.4\text{ k}\Omega$	58		479		479		479		ns
		$2.7\text{ V} \leq EV_{DD} < 4.0\text{ V}$ , $2.3\text{ V} \leq V_b \leq 2.7\text{ V}$ , $C_b = 20\text{ pF}$ , $R_b = 2.7\text{ k}\Omega$	121		479		479		479		ns
Slp hold time (from SCKp $\uparrow$ ) <sup>Note 1</sup>	$t_{KSH1}$	$4.0\text{ V} \leq EV_{DD} \leq 5.5\text{ V}$ , $2.7\text{ V} \leq V_b \leq 4.0\text{ V}$ , $C_b = 20\text{ pF}$ , $R_b = 1.4\text{ k}\Omega$	10		10		10		10		ns
		$2.7\text{ V} \leq EV_{DD} < 4.0\text{ V}$ , $2.3\text{ V} \leq V_b \leq 2.7\text{ V}$ , $C_b = 20\text{ pF}$ , $R_b = 2.7\text{ k}\Omega$	10		10		10		10		ns
Delay time from SCKp $\downarrow$ to SOp output <sup>Note 1</sup>	$t_{KSO1}$	$4.0\text{ V} \leq EV_{DD} \leq 5.5\text{ V}$ , $2.7\text{ V} \leq V_b \leq 4.0\text{ V}$ , $C_b = 20\text{ pF}$ , $R_b = 1.4\text{ k}\Omega$		60	60		60		60		ns
		$2.7\text{ V} \leq EV_{DD} < 4.0\text{ V}$ , $2.3\text{ V} \leq V_b \leq 2.7\text{ V}$ , $C_b = 20\text{ pF}$ , $R_b = 2.7\text{ k}\Omega$		130	130		130		130		ns
Slp setup time (to SCKp $\downarrow$ ) <sup>Note 2</sup>	$t_{SIK1}$	$4.0\text{ V} \leq EV_{DD} \leq 5.5\text{ V}$ , $2.7\text{ V} \leq V_b \leq 4.0\text{ V}$ , $C_b = 20\text{ pF}$ , $R_b = 1.4\text{ k}\Omega$	23		110		110		110		ns
		$2.7\text{ V} \leq EV_{DD} < 4.0\text{ V}$ , $2.3\text{ V} \leq V_b \leq 2.7\text{ V}$ , $C_b = 20\text{ pF}$ , $R_b = 2.7\text{ k}\Omega$	33		110		110		110		ns

(Notes, Caution, and Remarks are listed on the next page.)

**(6) Communication at different potential (2.5 V, 3 V) ( $f_{MCK}/2$ ) (Simplified SPI (CSI) mode) (master mode, SCKp... internal clock output, corresponding CSI00 only) (2/2)**

( $T_A = -40$  to  $+85^\circ\text{C}$ ,  $2.7\text{ V} \leq V_{DD0} = V_{DD1} \leq V_{DD}^{\text{Note 3}} \leq 5.5\text{ V}$ ,  $V_{SS} = V_{SS0} = V_{SS1} = 0\text{ V}$ )

Parameter	Symbol	Conditions	HS (high-speed main) Mode		LS (low-speed main) Mode		LP (low-power main) Mode		LV (low-voltage main) Mode		Unit
			MIN.	MAX.	MIN.	MAX.	MIN.	MAX.	MIN.	MAX.	
Slp hold time (from SCKp↓) <sup>Note 2</sup>	$t_{KS11}$	$4.0\text{ V} \leq V_{DD} \leq 5.5\text{ V}$ , $2.7\text{ V} \leq V_b \leq 4.0\text{ V}$ , $C_b = 20\text{ pF}$ , $R_b = 1.4\text{ k}\Omega$	10		10		10		10		ns
		$2.7\text{ V} \leq V_{DD} < 4.0\text{ V}$ , $2.3\text{ V} \leq V_b \leq 2.7\text{ V}$ , $C_b = 20\text{ pF}$ , $R_b = 2.7\text{ k}\Omega$	10		10		10		10		ns
Delay time from SCKp↑ to SOp output <sup>Note 2</sup>	$t_{KS01}$	$4.0\text{ V} \leq V_{DD} \leq 5.5\text{ V}$ , $2.7\text{ V} \leq V_b \leq 4.0\text{ V}$ , $C_b = 20\text{ pF}$ , $R_b = 1.4\text{ k}\Omega$		10		10		10		10	ns
		$2.7\text{ V} \leq V_{DD} < 4.0\text{ V}$ , $2.3\text{ V} \leq V_b \leq 2.7\text{ V}$ , $C_b = 20\text{ pF}$ , $R_b = 2.7\text{ k}\Omega$		10		10		10		10	ns

- Notes**
1. When  $DAPmn = 0$  and  $CKPmn = 0$ , or  $DAPmn = 1$  and  $CKPmn = 1$ .
  2. When  $DAPmn = 0$  and  $CKPmn = 1$ , or  $DAPmn = 1$  and  $CKPmn = 0$ .
  3. Either  $V_{DD}$  or  $V_{BAT}$  is selected by the battery backup function.

**Caution** Select the TTL input buffer for the Slp pin and the N-ch open drain output ( $V_{DD}$  tolerance) mode for the SOp pin and SCKp pin by using port input mode register g (PIMg) and port output mode register g (POMg). For  $V_{IH}$  and  $V_{IL}$ , see the DC characteristics with TTL input buffer selected.

**Simplified SPI (CSI) mode connection diagram (during communication at different potential)**

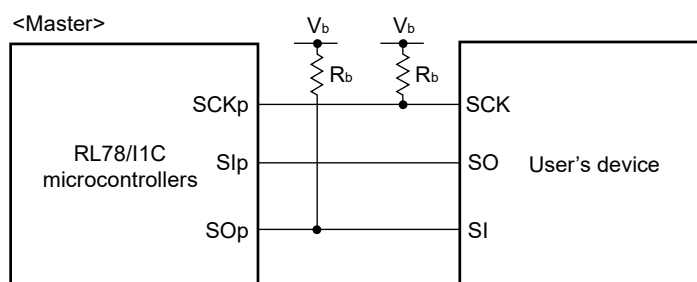

- Remarks**
1.  $R_b[\Omega]$ : Communication line (SCKp, SOp) pull-up resistance,  $C_b[F]$ : Communication line (SCKp, SOp) load capacitance,  $V_b[V]$ : Communication line voltage
  2. p: CSI number (p = 00, 10, 30), m: Unit number, n: Channel number (mn = 00, 02, 10), g: PIM and POM number (g = 0, 1, 8)
  3.  $f_{MCK}$ : Serial array unit operation clock frequency (Operating clock that is set with the serial clock select register m (SPSm) and the CKSmn bit of serial mode register mn (SMRmn). m: Unit number, n: Channel number (mn = 00, 02, 12))
  4. This specification is valid only when CSI00's peripheral I/O redirect function is not used.

(7) Communication at different potential (1.8 V, 2.5 V, 3 V) (f<sub>MCK/4</sub>) (Simplified SPI (CSI) mode) (master mode, SCKp... internal clock output) (1/2)(T<sub>A</sub> = -40 to +85°C, 1.9 V ≤ EV<sub>DD0</sub> = EV<sub>DD1</sub> ≤ V<sub>DD</sub><sup>Note 4</sup> ≤ 5.5 V, V<sub>SS</sub> = EV<sub>SS0</sub> = EV<sub>SS1</sub> = 0 V)

Parameter	Symbol	Conditions	HS (high-speed main) Mode		LS (low-speed main) Mode		LP (low-power main) Mode		LV (low-voltage main) Mode		Unit
			MIN.	MAX.	MIN.	MAX.	MIN.	MAX.	MIN.	MAX.	
SCKp cycle time	t <sub>KCY1</sub>	t <sub>KCY1</sub> ≥ 4/f <sub>CLK</sub> 4.0 V ≤ EV <sub>DD</sub> ≤ 5.5 V, 2.7 V ≤ V <sub>b</sub> ≤ 4.0 V, C <sub>b</sub> = 30 pF, R <sub>b</sub> = 1.4 kΩ	300		1150		1150		1150		ns
		2.7 V ≤ EV <sub>DD</sub> < 4.0 V, 2.3 V ≤ V <sub>b</sub> ≤ 2.7 V, C <sub>b</sub> = 30 pF, R <sub>b</sub> = 2.7 kΩ	500		1150		1150		1150		ns
		1.9 V ≤ EV <sub>DD</sub> < 3.3 V, 1.6 V ≤ V <sub>b</sub> ≤ 2.0 V, C <sub>b</sub> = 30 pF, R <sub>b</sub> = 5.5 kΩ	1150		1150		1150		1150		ns
SCKp high-level width	t <sub>KH1</sub>	4.0 V ≤ EV <sub>DD</sub> ≤ 5.5 V, 2.7 V ≤ V <sub>b</sub> ≤ 4.0 V, C <sub>b</sub> = 30 pF, R <sub>b</sub> = 1.4 kΩ	t <sub>KCY1</sub> / 2 – 75		t <sub>KCY1</sub> / 2 – 75		t <sub>KCY1</sub> / 2 – 75		t <sub>KCY1</sub> / 2 – 75		ns
		2.7 V ≤ EV <sub>DD</sub> < 4.0 V, 2.3 V ≤ V <sub>b</sub> ≤ 2.7 V, C <sub>b</sub> = 30 pF, R <sub>b</sub> = 2.7 kΩ	t <sub>KCY1</sub> / 2 – 170		t <sub>KCY1</sub> / 2 – 170		t <sub>KCY1</sub> / 2 – 170		t <sub>KCY1</sub> / 2 – 170		ns
		1.9 V <sup>Note 4</sup> ≤ EV <sub>DD</sub> < 3.3 V, 1.6 V ≤ V <sub>b</sub> ≤ 2.0 V <sup>Note 3</sup> , C <sub>b</sub> = 30 pF, R <sub>b</sub> = 5.5 kΩ	t <sub>KCY1</sub> / 2 – 458		t <sub>KCY1</sub> / 2 – 458		t <sub>KCY1</sub> / 2 – 458		t <sub>KCY1</sub> / 2 – 458		ns
SCKp low-level width	t <sub>KL1</sub>	4.0 V ≤ EV <sub>DD</sub> ≤ 5.5 V, 2.7 V ≤ V <sub>b</sub> ≤ 4.0 V, C <sub>b</sub> = 30 pF, R <sub>b</sub> = 1.4 kΩ	t <sub>KCY1</sub> / 2 – 12		t <sub>KCY1</sub> / 2 – 50		t <sub>KCY1</sub> / 2 – 50		t <sub>KCY1</sub> / 2 – 50		ns
		2.7 V ≤ EV <sub>DD</sub> < 4.0 V, 2.3 V ≤ V <sub>b</sub> ≤ 2.7 V, C <sub>b</sub> = 30 pF, R <sub>b</sub> = 2.7 kΩ	t <sub>KCY1</sub> / 2 – 18		t <sub>KCY1</sub> / 2 – 50		t <sub>KCY1</sub> / 2 – 50		t <sub>KCY1</sub> / 2 – 50		ns
		1.9 V <sup>Note 4</sup> ≤ EV <sub>DD</sub> < 3.3 V, 1.6 V ≤ V <sub>b</sub> ≤ 2.0 V <sup>Note 3</sup> , C <sub>b</sub> = 30 pF, R <sub>b</sub> = 5.5 kΩ	t <sub>KCY1</sub> / 2 – 50		t <sub>KCY1</sub> / 2 – 50		t <sub>KCY1</sub> / 2 – 50		t <sub>KCY1</sub> / 2 – 50		ns
Slp setup time (to SCKp↑) <sup>Note 1</sup>	t <sub>SIK1</sub>	4.0 V ≤ EV <sub>DD</sub> ≤ 5.5 V, 2.7 V ≤ V <sub>b</sub> ≤ 4.0 V, C <sub>b</sub> = 30 pF, R <sub>b</sub> = 1.4 kΩ	81		479		479		479		ns
		2.7 V ≤ EV <sub>DD</sub> < 4.0 V, 2.3 V ≤ V <sub>b</sub> ≤ 2.7 V, C <sub>b</sub> = 30 pF, R <sub>b</sub> = 2.7 kΩ	177		479		479		479		ns
		1.9 V ≤ EV <sub>DD</sub> < 3.3 V, 1.6 V ≤ V <sub>b</sub> ≤ 2.0 V <sup>Note 3</sup> , C <sub>b</sub> = 30 pF, R <sub>b</sub> = 5.5 kΩ	479		479		479		479		ns

(Notes, Caution and Remarks are listed on the page after the next page.)

(7) Communication at different potential (1.8 V, 2.5 V, 3 V) ( $f_{MCK}/4$ ) (Simplified SPI (CSI) mode) (master mode, SCKp... internal clock output) (2/2)(T<sub>A</sub> = -40 to +85°C, 1.9 V ≤ EV<sub>DD0</sub> = EV<sub>DD1</sub> ≤ V<sub>DD</sub><sup>Note 4</sup> ≤ 5.5 V, V<sub>SS</sub> = EV<sub>SS0</sub> = EV<sub>SS1</sub> = 0 V)

Parameter	Symbol	Conditions	HS (high-speed main) Mode		LS (low-speed main) Mode		LP (low-power main) Mode		LV (low-voltage main) Mode		Unit
			MIN.	MAX.	MIN.	MAX.	MIN.	MAX.	MIN.	MAX.	
Slp hold time (from SCKp↑) <sup>Note 1</sup>	t <sub>KS1</sub>	4.0 V ≤ EV <sub>DD</sub> ≤ 5.5 V, 2.7 V ≤ V <sub>b</sub> ≤ 4.0 V, C <sub>b</sub> = 30 pF, R <sub>b</sub> = 1.4 kΩ	19		19		19		19		ns
		2.7 V ≤ EV <sub>DD</sub> < 4.0 V, 2.3 V ≤ V <sub>b</sub> ≤ 2.7 V, C <sub>b</sub> = 30 pF, R <sub>b</sub> = 2.7 kΩ	19		19		19		19		ns
		1.9 V ≤ EV <sub>DD</sub> < 3.3 V, 1.6 V ≤ V <sub>b</sub> ≤ 2.0 V <sup>Note 3</sup> , C <sub>b</sub> = 30 pF, R <sub>b</sub> = 5.5 kΩ	19		19		19		19		ns
Delay time from SCKp↓ to SOp output <sup>Note 1</sup>	t <sub>KS01</sub>	4.0 V ≤ EV <sub>DD</sub> ≤ 5.5 V, 2.7 V ≤ V <sub>b</sub> ≤ 4.0 V, C <sub>b</sub> = 30 pF, R <sub>b</sub> = 1.4 kΩ		100		100		100		100	ns
		2.7 V ≤ EV <sub>DD</sub> < 4.0 V, 2.3 V ≤ V <sub>b</sub> ≤ 2.7 V, C <sub>b</sub> = 30 pF, R <sub>b</sub> = 2.7 kΩ		195		195		195		195	ns
		1.9 V ≤ EV <sub>DD</sub> < 3.3 V, 1.6 V ≤ V <sub>b</sub> ≤ 2.0 V <sup>Note 3</sup> , C <sub>b</sub> = 30 pF, R <sub>b</sub> = 5.5 kΩ		483		483		483		483	ns
Slp setup time (to SCKp↓) <sup>Note 2</sup>	t <sub>SIK1</sub>	4.0 V ≤ EV <sub>DD</sub> ≤ 5.5 V, 2.7 V ≤ V <sub>b</sub> ≤ 4.0 V, C <sub>b</sub> = 30 pF, R <sub>b</sub> = 1.4 kΩ	44		110		110		110		ns
		2.7 V ≤ EV <sub>DD</sub> < 4.0 V, 2.3 V ≤ V <sub>b</sub> ≤ 2.7 V, C <sub>b</sub> = 30 pF, R <sub>b</sub> = 2.7 kΩ	44		110		110		110		ns
		1.9 V ≤ EV <sub>DD</sub> < 3.3 V, 1.6 V ≤ V <sub>b</sub> ≤ 2.0 V <sup>Note 3</sup> , C <sub>b</sub> = 30 pF, R <sub>b</sub> = 5.5 kΩ	110		110		110		110		ns
Slp hold time (from SCKp↓) <sup>Note 2</sup>	t <sub>KS1</sub>	4.0 V ≤ EV <sub>DD</sub> ≤ 5.5 V, 2.7 V ≤ V <sub>b</sub> ≤ 4.0 V, C <sub>b</sub> = 30 pF, R <sub>b</sub> = 1.4 kΩ	19		19		19		19		ns
		2.7 V ≤ EV <sub>DD</sub> < 4.0 V, 2.3 V ≤ V <sub>b</sub> ≤ 2.7 V, C <sub>b</sub> = 30 pF, R <sub>b</sub> = 2.7 kΩ	19		19		19		19		ns
		1.9 V ≤ EV <sub>DD</sub> < 3.3 V, 1.6 V ≤ V <sub>b</sub> ≤ 2.0 V <sup>Note 3</sup> , C <sub>b</sub> = 30 pF, R <sub>b</sub> = 5.5 kΩ	19		19		19		19		ns
Delay time from SCKp↑ to SOp output <sup>Note 2</sup>	t <sub>KS01</sub>	4.0 V ≤ EV <sub>DD</sub> ≤ 5.5 V, 2.7 V ≤ V <sub>b</sub> ≤ 4.0 V, C <sub>b</sub> = 30 pF, R <sub>b</sub> = 1.4 kΩ		25		25		25		25	ns
		2.7 V ≤ EV <sub>DD</sub> < 4.0 V, 2.3 V ≤ V <sub>b</sub> ≤ 2.7 V, C <sub>b</sub> = 30 pF, R <sub>b</sub> = 2.7 kΩ		25		25		25		25	ns
		1.9 V ≤ EV <sub>DD</sub> < 3.3 V, 1.6 V ≤ V <sub>b</sub> ≤ 2.0 V <sup>Note 3</sup> , C <sub>b</sub> = 30 pF, R <sub>b</sub> = 5.5 kΩ		25		25		25		25	ns

(Notes, Caution and Remarks are listed on the next page.)



- Notes**
1. When DAPmn = 0 and CKPmn = 0, or DAPmn = 1 and CKPmn = 1.
  2. When DAPmn = 0 and CKPmn = 1, or DAPmn = 1 and CKPmn = 0.
  3. Use it with  $EV_{DD} \geq V_b$ .
  4. Either  $V_{DD}$  or  $V_{BAT}$  is selected by the battery backup function.

**Caution** Select the TTL input buffer for the SIp pin and the N-ch open drain output ( $V_{DD}$  tolerance) mode for the SOp pin and SCKp pin by using port input mode register g (PIMg) and port output mode register g (POMg). For  $V_{IH}$  and  $V_{IL}$ , see the DC characteristics with TTL input buffer selected.

- Remarks**
1.  $R_b[\Omega]$ : Communication line (SCKp, SOp) pull-up resistance,  $C_b[F]$ : Communication line (SCKp, SOp) load capacitance,  $V_b[V]$ : Communication line voltage
  2. p: CSI number (p = 00, 10, 30), m: Unit number, n: Channel number (mn = 00, 02, 10), g: PIM and POM number (g = 0, 1, 8)
  3.  $f_{MCK}$ : Serial array unit operation clock frequency  
(Operation clock to be set by the CKSmn bit of serial mode register mn (SMRmn).  
m: Unit number, n: Channel number (mn = 00, 02, 12))

**Simplified SPI (CSI) mode connection diagram (during communication at different potential)**

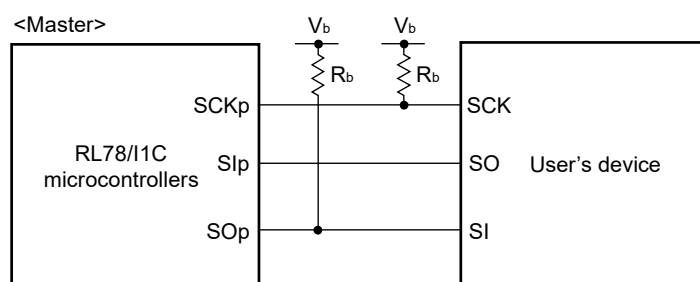

**Simplified SPI (CSI) mode serial transfer timing (master mode) (during communication at different potential)  
(when DAPmn = 0 and CKPmn = 0, or DAPmn = 1 and CKPmn = 1)**

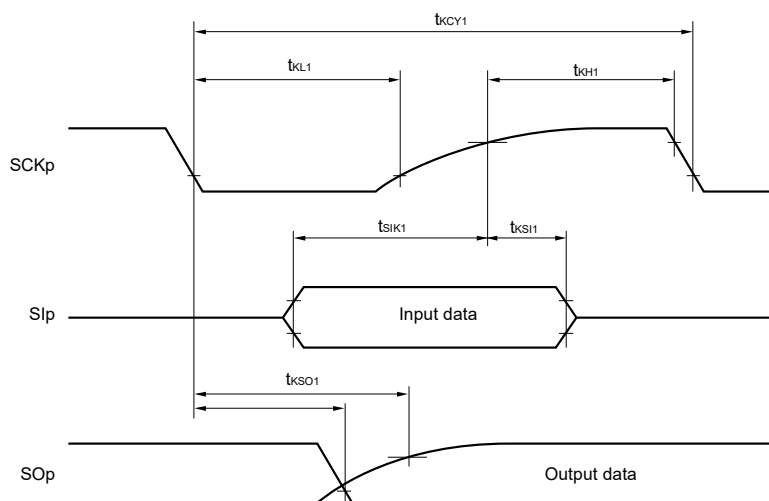

**Simplified SPI (CSI) mode serial transfer timing (master mode) (during communication at different potential)  
(when DAPmn = 0 and CKPmn = 1, or DAPmn = 1 and CKPmn = 0)**

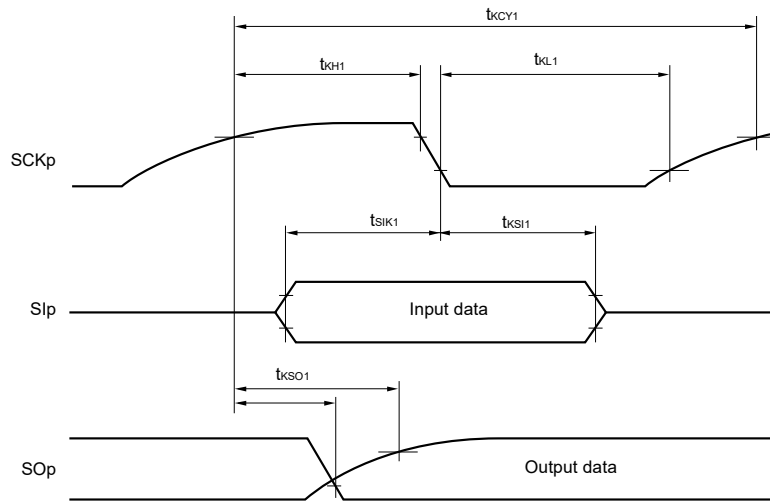

**Caution** Select the TTL input buffer for the SIp pin and the N-ch open drain output ( $V_{DD}$  tolerance) mode for the SOp pin and SCKp pin by using port input mode register g (PIMg) and port output mode register g (POMg). For  $V_{IH}$  and  $V_{IL}$ , see the DC characteristics with TTL input buffer selected.

**Remark** p: CSI number (p = 00, 10, 30), m: Unit number, n: Channel number (mn = 00, 02, 10),  
g: PIM and POM number (g = 0, 1, 8)

**(8) Communication at different potential (1.8 V, 2.5 V, 3 V) (Simplified SPI (CSI) mode) (slave mode, SCKp ... external clock input)****( $T_A = -40$  to  $+85^\circ\text{C}$ ,  $1.9\text{ V} \leq \text{EVDD}_0 = \text{EVDD}_1 \leq \text{VDD}^{\text{Note 5}} \leq 5.5\text{ V}$ ,  $\text{VSS} = \text{EVSS}_0 = \text{EVSS}_1 = 0\text{ V}$ ) (1/2)**

Parameter	Symbol	Conditions		HS (high-speed main) Mode		LS (low-speed main) Mode		LP (low-power main) Mode		LV (low-voltage main) Mode		Unit	
				MIN.	MAX.	MIN.	MAX.	MIN.	MAX.	MIN.	MAX.		
SCKp cycle time <sup>Note 1</sup>	$t_{\text{CY2}}$	$4.0\text{ V} \leq \text{EVDD} \leq 5.5\text{ V}$ , $2.7\text{ V} \leq \text{V}_b \leq 4.0\text{ V}$	$24\text{ MHz} < f_{\text{MCK}}$	$14/f_{\text{MCK}}$		–		–		–		ns	
			$20\text{ MHz} < f_{\text{MCK}} \leq 24\text{ MHz}$	$12/f_{\text{MCK}}$		–		–		–		ns	
			$8\text{ MHz} < f_{\text{MCK}} \leq 20\text{ MHz}$	$10/f_{\text{MCK}}$		–		–		–		ns	
			$4\text{ MHz} < f_{\text{MCK}} \leq 8\text{ MHz}$	$8/f_{\text{MCK}}$		$16/f_{\text{MCK}}$		–		–		ns	
			$f_{\text{MCK}} \leq 4\text{ MHz}$	$6/f_{\text{MCK}}$		$10/f_{\text{MCK}}$		$10/f_{\text{MCK}}$		$10/f_{\text{MCK}}$		$10/f_{\text{MCK}}$	ns
		$2.7\text{ V} \leq \text{EVDD} < 4.0\text{ V}$ , $2.3\text{ V} \leq \text{V}_b \leq 2.7\text{ V}$	$24\text{ MHz} < f_{\text{MCK}}$	$20/f_{\text{MCK}}$		–		–		–		–	ns
			$20\text{ MHz} < f_{\text{MCK}} \leq 24\text{ MHz}$	$16/f_{\text{MCK}}$		–		–		–		–	ns
			$16\text{ MHz} < f_{\text{MCK}} \leq 20\text{ MHz}$	$14/f_{\text{MCK}}$		–		–		–		–	ns
			$8\text{ MHz} < f_{\text{MCK}} \leq 16\text{ MHz}$	$12/f_{\text{MCK}}$		–		–		–		–	ns
			$4\text{ MHz} < f_{\text{MCK}} \leq 8\text{ MHz}$	$8/f_{\text{MCK}}$		$16/f_{\text{MCK}}$		–		–		–	ns
		$1.9\text{ V} \leq \text{EVDD} < 3.3\text{ V}$ , $1.6\text{ V} \leq \text{V}_b \leq 2.0\text{ V}^{\text{Note 2}}$	$24\text{ MHz} < f_{\text{MCK}}$	$48/f_{\text{MCK}}$		–		–		–		–	ns
			$20\text{ MHz} < f_{\text{MCK}} \leq 24\text{ MHz}$	$36/f_{\text{MCK}}$		–		–		–		–	ns
			$16\text{ MHz} < f_{\text{MCK}} \leq 20\text{ MHz}$	$32/f_{\text{MCK}}$		–		–		–		–	ns
			$8\text{ MHz} < f_{\text{MCK}} \leq 16\text{ MHz}$	$26/f_{\text{MCK}}$		–		–		–		–	ns
			$4\text{ MHz} < f_{\text{MCK}} \leq 8\text{ MHz}$	$16/f_{\text{MCK}}$		$16/f_{\text{MCK}}$		–		–		–	ns
				$f_{\text{MCK}} \leq 4\text{ MHz}$		$10/f_{\text{MCK}}$		$10/f_{\text{MCK}}$		$10/f_{\text{MCK}}$		$10/f_{\text{MCK}}$	
SCKp high-/low-level width	$t_{\text{KH2}}$ , $t_{\text{KL2}}$	$4.0\text{ V} \leq \text{EVDD} \leq 5.5\text{ V}$ , $2.7\text{ V} \leq \text{V}_b \leq 4.0\text{ V}$	$t_{\text{CY2}}/2 - 12$		$t_{\text{CY2}}/2 - 50$		$t_{\text{CY2}}/2 - 50$		$t_{\text{CY2}}/2 - 50$		$t_{\text{CY2}}/2 - 50$	ns	
			$2.7\text{ V} \leq \text{EVDD} < 4.0\text{ V}$ , $2.3\text{ V} \leq \text{V}_b \leq 2.7\text{ V}$	$t_{\text{CY2}}/2 - 18$		$t_{\text{CY2}}/2 - 50$		$t_{\text{CY2}}/2 - 50$		$t_{\text{CY2}}/2 - 50$		$t_{\text{CY2}}/2 - 50$	ns
			$1.9\text{ V} \leq \text{EVDD} < 3.3\text{ V}$ , $1.6\text{ V} \leq \text{V}_b \leq 2.0\text{ V}^{\text{Note 2}}$	$t_{\text{CY2}}/2 - 50$		$t_{\text{CY2}}/2 - 50$		$t_{\text{CY2}}/2 - 50$		$t_{\text{CY2}}/2 - 50$		$t_{\text{CY2}}/2 - 50$	ns
Slp setup time (to SCKp $\uparrow$ ) <sup>Note 3</sup>	$t_{\text{SIK2}}$	$2.7\text{ V} \leq \text{EVDD} \leq 5.5\text{ V}$ , $2.3\text{ V} \leq \text{V}_b \leq 4.0\text{ V}^{\text{Note 2}}$	$1/f_{\text{MCK}} + 20$		$1/f_{\text{MCK}} + 30$		$1/f_{\text{MCK}} + 30$		$1/f_{\text{MCK}} + 30$		$1/f_{\text{MCK}} + 30$	ns	
			$1.9\text{ V} \leq \text{EVDD} < 3.3\text{ V}$ , $1.6\text{ V} \leq \text{V}_b \leq 2.0\text{ V}^{\text{Note 2}}$	$1/f_{\text{MCK}} + 30$		$1/f_{\text{MCK}} + 30$		$1/f_{\text{MCK}} + 30$		$1/f_{\text{MCK}} + 30$		$1/f_{\text{MCK}} + 30$	ns
Slp hold time (from SCKp $\uparrow$ ) <sup>Note 3</sup>	$t_{\text{KSI2}}$	$2.7\text{ V} \leq \text{EVDD} \leq 5.5\text{ V}$ , $2.3\text{ V} \leq \text{V}_b \leq 4.0\text{ V}^{\text{Note 2}}$	$1/f_{\text{MCK}} + 31$		$1/f_{\text{MCK}} + 31$		$1/f_{\text{MCK}} + 31$		$1/f_{\text{MCK}} + 31$		$1/f_{\text{MCK}} + 31$	ns	
			$1.9\text{ V} \leq \text{EVDD} < 3.3\text{ V}$ , $1.6\text{ V} \leq \text{V}_b \leq 2.0\text{ V}^{\text{Note 2}}$	$1/f_{\text{MCK}} + 31$		$1/f_{\text{MCK}} + 31$		$1/f_{\text{MCK}} + 31$		$1/f_{\text{MCK}} + 31$		$1/f_{\text{MCK}} + 31$	ns

**(Notes, Caution and Remarks are listed on the next page.)**

**(8) Communication at different potential (1.8 V, 2.5 V, 3 V) (Simplified SPI (CSI) mode) (slave mode, SCKp ... external clock input)**

( $T_A = -40$  to  $+85^\circ\text{C}$ ,  $1.9\text{ V} \leq EV_{DD0} = EV_{DD1} \leq V_{DD}^{\text{Note 5}} \leq 5.5\text{ V}$ ,  $V_{SS} = EV_{SS0} = EV_{SS1} = 0\text{ V}$ ) (2/2)

Parameter	Symbol	Conditions	HS (high-speed main) Mode		LS (low-speed main) Mode		LP (low-power main) Mode		LV (low-voltage main) Mode		Unit
			MIN.	MAX.	MIN.	MAX.	MIN.	MAX.	MIN.	MAX.	
Delay time from SCKp↓ to SOp output <sup>Note 4</sup>	$t_{kSO2}$	$4.0\text{ V} \leq EV_{DD} \leq 5.5\text{ V}$ , $2.7\text{ V} \leq V_b \leq 4.0\text{ V}$ , $C_b = 30\text{ pF}$ , $R_b = 1.4\text{ k}\Omega$		$2/f_{MCK}$ + 120		$2/f_{MCK}$ + 573		$2/f_{MCK}$ + 573		$2/f_{MCK}$ + 573	ns
		$2.7\text{ V} \leq EV_{DD} < 4.0\text{ V}$ , $2.3\text{ V} \leq V_b \leq 2.7\text{ V}$ , $C_b = 30\text{ pF}$ , $R_b = 2.7\text{ k}\Omega$		$2/f_{MCK}$ + 214		$2/f_{MCK}$ + 573		$2/f_{MCK}$ + 573		$2/f_{MCK}$ + 573	ns
		$1.9\text{ V} \leq EV_{DD} < 3.3\text{ V}$ , $1.6\text{ V} \leq V_b \leq 2.0\text{ V}^{\text{Note 2}}$ , $C_b = 30\text{ pF}$ , $R_b = 5.5\text{ k}\Omega$		$2/f_{MCK}$ + 573		$2/f_{MCK}$ + 573		$2/f_{MCK}$ + 573		$2/f_{MCK}$ + 573	ns

- Notes**
1. Transfer rate in the SNOOZE mode: MAX. 1 Mbps
  2. Use it with  $EV_{DD} \geq V_b$ .
  3. When  $DAPmn = 0$  and  $CKPmn = 0$ , or  $DAPmn = 1$  and  $CKPmn = 1$ . The Slp setup time becomes “to SCKp↓” when  $DAPmn = 0$  and  $CKPmn = 1$ , or  $DAPmn = 1$  and  $CKPmn = 0$ .
  4. When  $DAPmn = 0$  and  $CKPmn = 0$ , or  $DAPmn = 1$  and  $CKPmn = 1$ . The Slp hold time becomes “from SCKp↑” when  $DAPmn = 0$  and  $CKPmn = 1$ , or  $DAPmn = 1$  and  $CKPmn = 0$ .
  5. Either  $V_{DD}$  or  $V_{BAT}$  is selected by the battery backup function.

**Caution** Select the TTL input buffer for the Slp pin and SCKp pin and the N-ch open drain output ( $V_{DD}$  tolerance) mode for the SOp pin by using port input mode register g (PIMg) and port output mode register g (POMg). For  $V_{IH}$  and  $V_{IL}$ , see the DC characteristics with TTL input buffer selected.

**Simplified SPI (CSI) mode connection diagram (during communication at different potential)**

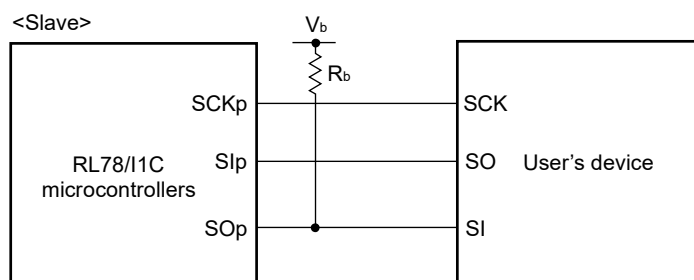

- Remarks**
1.  $R_b[\Omega]$ : Communication line (SO<sub>p</sub>) pull-up resistance,  $C_b[F]$ : Communication line (SO<sub>p</sub>) load capacitance,  $V_b[V]$ : Communication line voltage
  2. p: CSI number (p = 00, 10, 30), m: Unit number, n: Channel number (mn = 00, 02, 10), g: PIM and POM number (g = 0, 1, 8)
  3.  $f_{MCK}$ : Serial array unit operation clock frequency  
(Operating clock that is set with the serial clock select register m (SPSm) and the CKSmn bit of serial mode register mn (SMRmn).  
m: Unit number, n: Channel number (mn = 00, 02, 12))

**Simplified SPI (CSI) mode serial transfer timing (slave mode) (during communication at different potential)  
(when DAPmn = 0 and CKPmn = 0, or DAPmn = 1 and CKPmn = 1)**

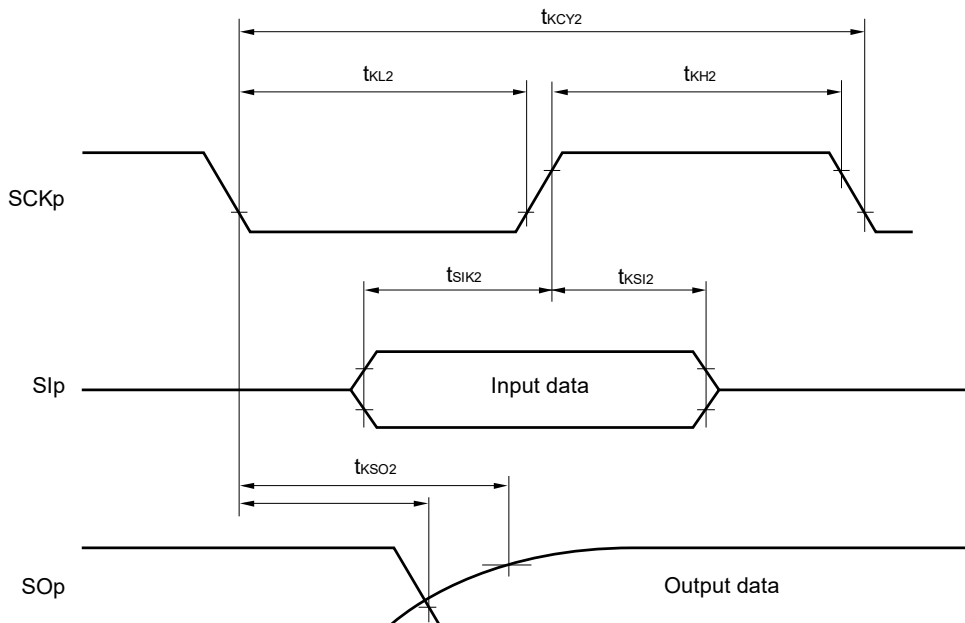

**Simplified SPI (CSI) mode serial transfer timing (slave mode) (during communication at different potential)  
(When DAPmn = 0 and CKPmn = 1, or DAPmn = 1 and CKPmn = 0.)**

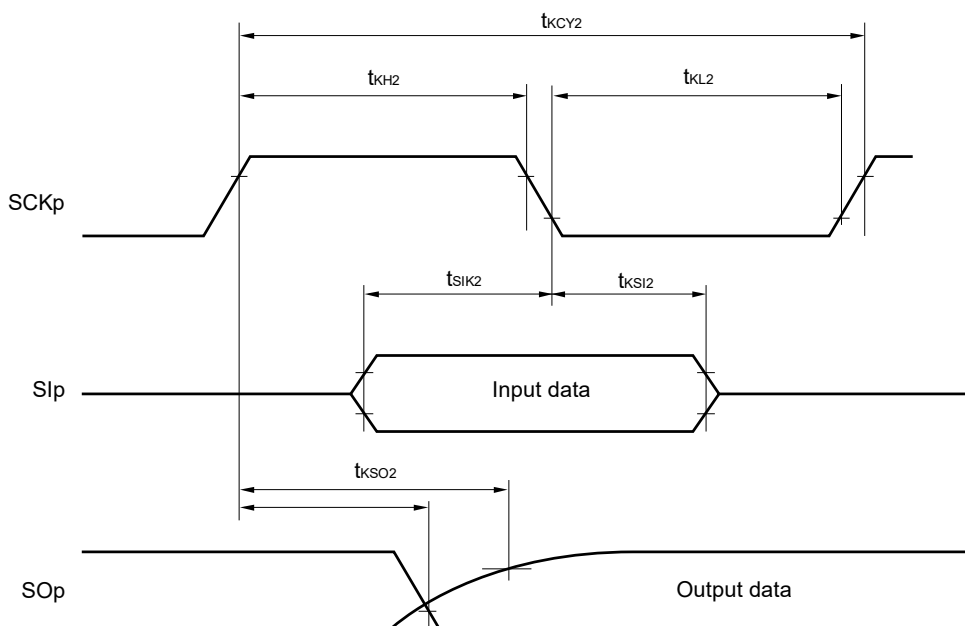

**Caution** Select the TTL input buffer for the SIp pin and SCKp pin and the N-ch open drain output ( $V_{DD}$  tolerance) mode for the SOp pin by using port input mode register g (PIMg) and port output mode register g (POMg). For  $V_{IH}$  and  $V_{IL}$ , see the DC characteristics with TTL input buffer selected.

**Remark** p: CSI number (p = 00, 10, 30), m: Unit number, n: Channel number (mn = 00, 02, 12),  
g: PIM and POM number (g = 0, 1, 8)

(9) Communication at different potential (1.8 V, 2.5 V, 3 V) (simplified I<sup>2</sup>C mode) (1/2)(T<sub>A</sub> = -40 to +85°C, 1.9 V ≤ EV<sub>DD0</sub> = EV<sub>DD1</sub> ≤ V<sub>DD</sub><sup>Note 4</sup> ≤ 5.5 V, V<sub>SS</sub> = EV<sub>SS0</sub> = EV<sub>SS1</sub> = 0 V)

Parameter	Symbol	Conditions	HS (high-speed main) Mode		LS (low-speed main) Mode		LP (low-power main) Mode		LV (low-voltage main) Mode		Unit
			MIN.	MAX.	MIN.	MAX.	MIN.	MAX.	MIN.	MAX.	
SCLr clock frequency	f <sub>SCL</sub>	4.0 V ≤ EV <sub>DD</sub> ≤ 5.5 V, 2.7 V ≤ V <sub>b</sub> ≤ 4.0 V, C <sub>b</sub> = 50 pF, R <sub>b</sub> = 2.7 kΩ		1000 <sup>Note 1</sup>		300 <sup>Note 1</sup>		300 <sup>Note 1</sup>		300 <sup>Note 1</sup>	kHz
		2.7 V ≤ EV <sub>DD</sub> < 4.0 V, 2.3 V ≤ V <sub>b</sub> ≤ 2.7 V, C <sub>b</sub> = 50 pF, R <sub>b</sub> = 2.7 kΩ		1000 <sup>Note 1</sup>		300 <sup>Note 1</sup>		300 <sup>Note 1</sup>		300 <sup>Note 1</sup>	kHz
		4.0 V ≤ EV <sub>DD</sub> ≤ 5.5 V, 2.7 V ≤ V <sub>b</sub> ≤ 4.0 V, C <sub>b</sub> = 100 pF, R <sub>b</sub> = 2.8 kΩ		400 <sup>Note 1</sup>		300 <sup>Note 1</sup>		300 <sup>Note 1</sup>		300 <sup>Note 1</sup>	kHz
		2.7 V ≤ EV <sub>DD</sub> < 4.0 V, 2.3 V ≤ V <sub>b</sub> ≤ 2.7 V, C <sub>b</sub> = 100 pF, R <sub>b</sub> = 2.7 kΩ		400 <sup>Note 1</sup>		300 <sup>Note 1</sup>		300 <sup>Note 1</sup>		300 <sup>Note 1</sup>	kHz
		1.9 V ≤ EV <sub>DD</sub> < 3.3 V, 1.6 V ≤ V <sub>b</sub> ≤ 2.0 V <sup>Note 2</sup> , C <sub>b</sub> = 100 pF, R <sub>b</sub> = 5.5 kΩ		300 <sup>Note 1</sup>		300 <sup>Note 1</sup>		300 <sup>Note 1</sup>		300 <sup>Note 1</sup>	kHz
Hold time when SCLr = "L"	t <sub>LOW</sub>	4.0 V ≤ EV <sub>DD</sub> ≤ 5.5 V, 2.7 V ≤ V <sub>b</sub> ≤ 4.0 V, C <sub>b</sub> = 50 pF, R <sub>b</sub> = 2.7 kΩ	475		1550		1550		1550		ns
		2.7 V ≤ EV <sub>DD</sub> < 4.0 V, 2.3 V ≤ V <sub>b</sub> ≤ 2.7 V, C <sub>b</sub> = 50 pF, R <sub>b</sub> = 2.7 kΩ	475		1550		1550		1550		ns
		4.0 V ≤ EV <sub>DD</sub> ≤ 5.5 V, 2.7 V ≤ V <sub>b</sub> ≤ 4.0 V, C <sub>b</sub> = 100 pF, R <sub>b</sub> = 2.8 kΩ	1150		1150		1150		1150		ns
		2.7 V ≤ EV <sub>DD</sub> < 4.0 V, 2.3 V ≤ V <sub>b</sub> ≤ 2.7 V, C <sub>b</sub> = 100 pF, R <sub>b</sub> = 2.7 kΩ	1150		1150		1150		1150		ns
		1.9 V ≤ EV <sub>DD</sub> < 3.3 V, 1.6 V ≤ V <sub>b</sub> ≤ 2.0 V <sup>Note 2</sup> , C <sub>b</sub> = 100 pF, R <sub>b</sub> = 5.5 kΩ	1150		1150		1150		1150		ns
Hold time when SCLr = "H"	t <sub>HIGH</sub>	4.0 V ≤ EV <sub>DD</sub> ≤ 5.5 V, 2.7 V ≤ V <sub>b</sub> ≤ 4.0 V, C <sub>b</sub> = 50 pF, R <sub>b</sub> = 2.7 kΩ	245		610		610		610		ns
		2.7 V ≤ EV <sub>DD</sub> < 4.0 V, 2.3 V ≤ V <sub>b</sub> ≤ 2.7 V, C <sub>b</sub> = 50 pF, R <sub>b</sub> = 2.7 kΩ	200		610		610		610		ns
		4.0 V ≤ EV <sub>DD</sub> ≤ 5.5 V, 2.7 V ≤ V <sub>b</sub> ≤ 4.0 V, C <sub>b</sub> = 100 pF, R <sub>b</sub> = 2.8 kΩ	675		610		610		610		ns
		2.7 V ≤ EV <sub>DD</sub> < 4.0 V, 2.3 V ≤ V <sub>b</sub> ≤ 2.7 V, C <sub>b</sub> = 100 pF, R <sub>b</sub> = 2.7 kΩ	600		610		610		610		ns
		1.9 V ≤ EV <sub>DD</sub> < 3.3 V, 1.6 V ≤ V <sub>b</sub> ≤ 2.0 V <sup>Note 2</sup> , C <sub>b</sub> = 100 pF, R <sub>b</sub> = 5.5 kΩ	610		610		610		610		ns

(Notes, Caution and Remarks are listed on the next page.)

**(9) Communication at different potential (1.8 V, 2.5 V, 3 V) (simplified I<sup>2</sup>C mode) (2/2)****(T<sub>A</sub> = -40 to +85°C, 1.9 V ≤ EV<sub>DD0</sub> = EV<sub>DD1</sub> ≤ V<sub>DD</sub><sup>Note 4</sup> ≤ 5.5 V, V<sub>SS</sub> = EV<sub>SS0</sub> = EV<sub>SS1</sub> = 0 V)**

Parameter	Symbol	Conditions	HS (high-speed main) Mode		LS (low-speed main) Mode		LP (low-power main) Mode		LV (low-voltage main) Mode		Unit
			MIN.	MAX.	MIN.	MAX.	MIN.	MAX.	MIN.	MAX.	
Data setup time (reception)	t <sub>SU, DAT</sub>	4.0 V ≤ EV <sub>DD</sub> ≤ 5.5 V, 2.7 V ≤ V <sub>b</sub> ≤ 4.0 V, C <sub>b</sub> = 50 pF, R <sub>b</sub> = 2.7 kΩ	1/f <sub>MCK</sub> + 135 <sup>Note 3</sup>		1/f <sub>MCK</sub> + 190 <sup>Note 3</sup>		1/f <sub>MCK</sub> + 190 <sup>Note 3</sup>		1/f <sub>MCK</sub> + 190 <sup>Note 3</sup>		ns
		2.7 V ≤ EV <sub>DD</sub> < 4.0 V, 2.3 V ≤ V <sub>b</sub> ≤ 2.7 V, C <sub>b</sub> = 50 pF, R <sub>b</sub> = 2.7 kΩ	1/f <sub>MCK</sub> + 135 <sup>Note 3</sup>		1/f <sub>MCK</sub> + 190 <sup>Note 3</sup>		1/f <sub>MCK</sub> + 190 <sup>Note 3</sup>		1/f <sub>MCK</sub> + 190 <sup>Note 3</sup>		ns
		4.0 V ≤ EV <sub>DD</sub> ≤ 5.5 V, 2.7 V ≤ V <sub>b</sub> ≤ 4.0 V, C <sub>b</sub> = 100 pF, R <sub>b</sub> = 2.8 kΩ	1/f <sub>MCK</sub> + 190 <sup>Note 3</sup>		1/f <sub>MCK</sub> + 190 <sup>Note 3</sup>		1/f <sub>MCK</sub> + 190 <sup>Note 3</sup>		1/f <sub>MCK</sub> + 190 <sup>Note 3</sup>		ns
		2.7 V ≤ EV <sub>DD</sub> < 4.0 V, 2.3 V ≤ V <sub>b</sub> ≤ 2.7 V, C <sub>b</sub> = 100 pF, R <sub>b</sub> = 2.7 kΩ	1/f <sub>MCK</sub> + 190 <sup>Note 3</sup>		1/f <sub>MCK</sub> + 190 <sup>Note 3</sup>		1/f <sub>MCK</sub> + 190 <sup>Note 3</sup>		1/f <sub>MCK</sub> + 190 <sup>Note 3</sup>		ns
		1.9 V ≤ EV <sub>DD</sub> < 3.3 V, 1.6 V ≤ V <sub>b</sub> ≤ 2.0 V <sup>Note 2</sup> , C <sub>b</sub> = 100 pF, R <sub>b</sub> = 5.5 kΩ	1/f <sub>MCK</sub> + 190 <sup>Note 3</sup>		1/f <sub>MCK</sub> + 190 <sup>Note 3</sup>		1/f <sub>MCK</sub> + 190 <sup>Note 3</sup>		1/f <sub>MCK</sub> + 190 <sup>Note 3</sup>		ns
Data hold time (transmission)	t <sub>HD, DAT</sub>	4.0 V ≤ EV <sub>DD</sub> ≤ 5.5 V, 2.7 V ≤ V <sub>b</sub> ≤ 4.0 V, C <sub>b</sub> = 50 pF, R <sub>b</sub> = 2.7 kΩ	0	305	0	305	0	305	0	305	ns
		2.7 V ≤ EV <sub>DD</sub> < 4.0 V, 2.3 V ≤ V <sub>b</sub> ≤ 2.7 V, C <sub>b</sub> = 50 pF, R <sub>b</sub> = 2.7 kΩ	0	305	0	305	0	305	0	305	ns
		4.0 V ≤ EV <sub>DD</sub> ≤ 5.5 V, 2.7 V ≤ V <sub>b</sub> ≤ 4.0 V, C <sub>b</sub> = 100 pF, R <sub>b</sub> = 2.8 kΩ	0	355	0	355	0	355	0	355	ns
		2.7 V ≤ EV <sub>DD</sub> < 4.0 V, 2.3 V ≤ V <sub>b</sub> ≤ 2.7 V, C <sub>b</sub> = 100 pF, R <sub>b</sub> = 2.7 kΩ	0	355	0	355	0	355	0	355	ns
		1.9 V ≤ EV <sub>DD</sub> < 3.3 V, 1.6 V ≤ V <sub>b</sub> ≤ 2.0 V <sup>Note 2</sup> , C <sub>b</sub> = 100 pF, R <sub>b</sub> = 5.5 kΩ	0	405	0	405	0	405	0	405	ns

**Notes 1.** The value must also be equal to or less than f<sub>MCK</sub>/4.**2.** Use it with EV<sub>DD</sub> ≥ V<sub>b</sub>.**3.** Set the f<sub>MCK</sub> value to keep the hold time of SCLr = "L" and SCLr = "H".**4.** Either V<sub>DD</sub> or V<sub>BAT</sub> is selected by the battery backup function.

**Caution** Select the TTL input buffer and the N-ch open drain output (V<sub>DD</sub> tolerance) mode for the SDAr pin and the N-ch open drain output (V<sub>DD</sub> tolerance) mode for the SCLr pin by using port input mode register g (PIMg) and port output mode register g (POMg). For V<sub>IH</sub> and V<sub>IL</sub>, see the DC characteristics with TTL input buffer selected.

(Remarks are listed on the next page.)

Simplified I<sup>2</sup>C mode connection diagram (during communication at different potential)

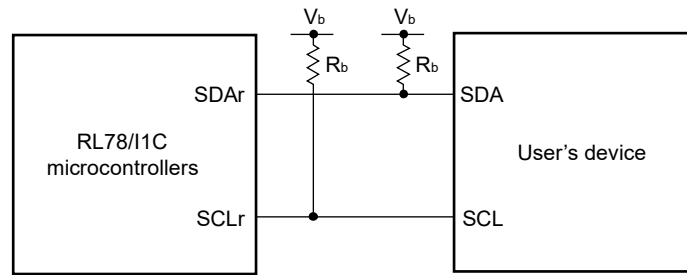

Simplified I<sup>2</sup>C mode serial transfer timing (during communication at different potential)

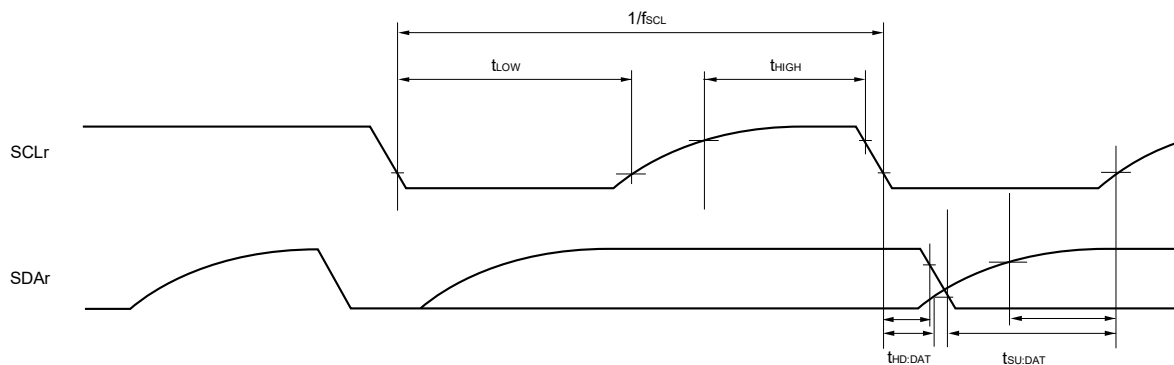

**Caution** Select the TTL input buffer and the N-ch open drain output ( $V_{DD}$  tolerance) mode for the SDAr pin and the N-ch open drain output ( $V_{DD}$  tolerance) mode for the SCLr pin by using port input mode register g (PIMg) and port output mode register g (POMg). For  $V_{IH}$  and  $V_{IL}$ , see the DC characteristics with TTL input buffer selected.

- Remarks**
1.  $R_b[\Omega]$ : Communication line (SDAr, SCLr) pull-up resistance,  $C_b[F]$ : Communication line (SDAr, SCLr) load capacitance,  $V_b[V]$ : Communication line voltage
  2. r: IIC number (r = 00, 10, 30), g: PIM, POM number (g = 0, 1, 8)
  3.  $f_{MCK}$ : Serial array unit operation clock frequency  
(Operating clock that is set with the serial clock select register m (SPSm) and the CKSmn bit of serial mode register mn (SMRmn).  
m: Unit number, n: Channel number (mn = 00, 02, 12))



## 2.5.2 Serial interface IICA

(1) I<sup>2</sup>C standard mode (1/2)(TA = -40 to +85°C, 1.7 V ≤ EVDD0 = EVDD1 ≤ VDD<sup>Note 3</sup> ≤ 5.5 V, VSS = EVSS0 = EVSS1 = 0 V)

Parameter	Symbol	Conditions	HS (high-speed main) Mode		LS (low-speed main) Mode		LP (low-power main) Mode		LV (low-voltage main) Mode		Unit	
			MIN.	MAX.	MIN.	MAX.	MIN.	MAX.	MIN.	MAX.		
SCLA0 clock frequency	f <sub>SCL</sub>	Standard mode: f <sub>CLK</sub> ≥ 1 MHz	2.7 V ≤ EV <sub>DD</sub> ≤ 5.5 V	0	100	0	100	0	100	0	100	kHz
			1.9 V ≤ EV <sub>DD</sub> ≤ 5.5 V	0	100	0	100	0	100	0	100	kHz
			1.8 V ≤ EV <sub>DD</sub> ≤ 5.5 V	0	100	0	100	0	100	0	100	kHz
			1.7 V ≤ EV <sub>DD</sub> ≤ 5.5 V	–	–	0	100	0	100	0	100	kHz
Setup time of restart condition	t <sub>SU:STA</sub>	2.7 V ≤ EV <sub>DD</sub> ≤ 5.5 V	4.7		4.7		4.7		4.7		μs	
		1.9 V ≤ EV <sub>DD</sub> ≤ 5.5 V	4.7		4.7		4.7		4.7		μs	
		1.8 V ≤ EV <sub>DD</sub> ≤ 5.5 V	4.7		4.7		4.7		4.7		μs	
		1.7 V ≤ EV <sub>DD</sub> ≤ 5.5 V	–	–	4.7		4.7		4.7		μs	
Hold time <sup>Note 1</sup>	t <sub>HD:STA</sub>	2.7 V ≤ EV <sub>DD</sub> ≤ 5.5 V	4.0		4.0		4.0		4.0		μs	
		1.9 V ≤ EV <sub>DD</sub> ≤ 5.5 V	4.0		4.0		4.0		4.0		μs	
		1.8 V ≤ EV <sub>DD</sub> ≤ 5.5 V	4.0		4.0		4.0		4.0		μs	
		1.7 V ≤ EV <sub>DD</sub> ≤ 5.5 V	–	–	4.0		4.0		4.0		μs	
Hold time when SCLA0 = "L"	t <sub>LOW</sub>	2.7 V ≤ EV <sub>DD</sub> ≤ 5.5 V	4.7		4.7		4.7		4.7		μs	
		1.9 V ≤ EV <sub>DD</sub> ≤ 5.5 V	4.7		4.7		4.7		4.7		μs	
		1.8 V ≤ EV <sub>DD</sub> ≤ 5.5 V	4.7		4.7		4.7		4.7		μs	
		1.7 V ≤ EV <sub>DD</sub> ≤ 5.5 V	–	–	4.7		4.7		4.7		μs	
Hold time when SCLA0 = "H"	t <sub>HIGH</sub>	2.7 V ≤ EV <sub>DD</sub> ≤ 5.5 V	4.0		4.0		4.0		4.0		μs	
		1.9 V ≤ EV <sub>DD</sub> ≤ 5.5 V	4.0		4.0		4.0		4.0		μs	
		1.8 V ≤ EV <sub>DD</sub> ≤ 5.5 V	4.0		4.0		4.0		4.0		μs	
		1.7 V ≤ EV <sub>DD</sub> ≤ 5.5 V	–	–	4.0		4.0		4.0		μs	
Data setup time (reception)	t <sub>SU:DAT</sub>	2.7 V ≤ EV <sub>DD</sub> ≤ 5.5 V	250		250		250		250		μs	
		1.9 V ≤ EV <sub>DD</sub> ≤ 5.5 V	250		250		250		250		μs	
		1.8 V ≤ EV <sub>DD</sub> ≤ 5.5 V	250		250		250		250		μs	
		1.7 V ≤ EV <sub>DD</sub> ≤ 5.5 V	–	–	250		250		250		μs	
Data hold time (transmission) <sup>Note 2</sup>	t <sub>HD:DAT</sub>	2.7 V ≤ EV <sub>DD</sub> ≤ 5.5 V	0	3.45	0	3.45	0	3.45	0	3.45	μs	
		1.9 V ≤ EV <sub>DD</sub> ≤ 5.5 V	0	3.45	0	3.45	0	3.45	0	3.45	μs	
		1.8 V ≤ EV <sub>DD</sub> ≤ 5.5 V	0	3.45	0	3.45	0	3.45	0	3.45	μs	
		1.7 V ≤ EV <sub>DD</sub> ≤ 5.5 V	–	–	0	3.45	0	3.45	0	3.45	μs	

(Notes and Remark are listed on the next page.)

(1) I<sup>2</sup>C standard mode (2/2)(T<sub>A</sub> = -40 to +85°C, 1.7 V ≤ EV<sub>DD0</sub> = EV<sub>DD1</sub> ≤ V<sub>DD</sub><sup>Note 3</sup> ≤ 5.5 V, V<sub>SS</sub> = EV<sub>SS0</sub> = EV<sub>SS1</sub> = 0 V)

Parameter	Symbol	Conditions	HS (high-speed main) Mode		LS (low-speed main) Mode		LP (low-power main) Mode		LV (low-voltage main) Mode		Unit
			MIN.	MAX.	MIN.	MAX.	MIN.	MAX.	MIN.	MAX.	
Setup time of stop condition	t <sub>SU:STO</sub>	2.7 V ≤ EV <sub>DD</sub> ≤ 5.5 V	4.0		4.0		4.0		4.0		μs
		1.9 V ≤ EV <sub>DD</sub> ≤ 5.5 V	4.0		4.0		4.0		4.0		μs
		1.8 V ≤ EV <sub>DD</sub> ≤ 5.5 V	4.0		4.0		4.0		4.0		μs
		1.7 V ≤ EV <sub>DD</sub> ≤ 5.5 V	–	–	4.0		4.0		4.0		μs
Bus-free time	t <sub>BUF</sub>	2.7 V ≤ EV <sub>DD</sub> ≤ 5.5 V	4.7		4.7		4.7		4.7		μs
		1.9 V ≤ EV <sub>DD</sub> ≤ 5.5 V	4.7		4.7		4.7		4.7		μs
		1.8 V ≤ EV <sub>DD</sub> ≤ 5.5 V	4.7		4.7		4.7		4.7		μs
		1.7 V ≤ EV <sub>DD</sub> ≤ 5.5 V	–	–	4.7		4.7		4.7		μs

- Notes**
1. The first clock pulse is generated after this period when the start/restart condition is detected.
  2. The maximum value (MAX.) of t<sub>HD:DAT</sub> is during normal transfer and a clock stretch state is inserted in the ACK (acknowledge) timing.
  3. Either V<sub>DD</sub> or V<sub>BAT</sub> is selected by the battery backup function.

**Remark** The maximum value of C<sub>b</sub> (communication line capacitance) and the value of R<sub>b</sub> (communication line pull-up resistor) at that time in each mode are as follows.

Standard mode: C<sub>b</sub> = 400 pF, R<sub>b</sub> = 2.7 kΩ

(2) I<sup>2</sup>C fast mode(T<sub>A</sub> = -40 to +85°C, 1.9 V ≤ EV<sub>DD0</sub> = EV<sub>DD1</sub> ≤ V<sub>DD</sub><sup>Note 3</sup> ≤ 5.5 V, V<sub>SS</sub> = EV<sub>SS0</sub> = EV<sub>SS1</sub> = 0 V)

Parameter	Symbol	Conditions		HS (high-speed main) Mode		LS (low-speed main) Mode		LP (low-power main) Mode		LV (low-voltage main) Mode		Unit
				MIN.	MAX.	MIN.	MAX.	MIN.	MAX.	MIN.	MAX.	
SCLA0 clock frequency	f <sub>SCL</sub>	Fast mode: f <sub>CLK</sub> ≥ 3.5 MHz	2.7 V ≤ EV <sub>DD</sub> ≤ 5.5 V	0	400	0	400	–	–	0	400	kHz
			1.9 V ≤ EV <sub>DD</sub> ≤ 5.5 V	0	400	0	400	–	–	0	400	kHz
Setup time of restart condition	t <sub>SU:STA</sub>	2.7 V ≤ EV <sub>DD</sub> ≤ 5.5 V		0.6		0.6		–	–	0.6		μs
		1.9 V ≤ EV <sub>DD</sub> ≤ 5.5 V		0.6		0.6		–	–	0.6		μs
Hold time <sup>Note 1</sup>	t <sub>HD:STA</sub>	2.7 V ≤ EV <sub>DD</sub> ≤ 5.5 V		0.6		0.6		–	–	0.6		μs
		1.9 V ≤ EV <sub>DD</sub> ≤ 5.5 V		0.6		0.6		–	–	0.6		μs
Hold time when SCLA0 = "L"	t <sub>LOW</sub>	2.7 V ≤ EV <sub>DD</sub> ≤ 5.5 V		1.3		1.3		–	–	1.3		μs
		1.9 V ≤ EV <sub>DD</sub> ≤ 5.5 V		1.3		1.3		–	–	1.3		μs
Hold time when SCLA0 = "H"	t <sub>HIGH</sub>	2.7 V ≤ EV <sub>DD</sub> ≤ 5.5 V		0.6		0.6		–	–	0.6		μs
		1.9 V ≤ EV <sub>DD</sub> ≤ 5.5 V		0.6		0.6		–	–	0.6		μs
Data setup time (reception)	t <sub>SU:DAT</sub>	2.7 V ≤ EV <sub>DD</sub> ≤ 5.5 V		100		100		–	–	100		ns
		1.9 V ≤ EV <sub>DD</sub> ≤ 5.5 V		100		100		–	–	100		ns
Data hold time (transmission) <sup>Note 2</sup>	t <sub>HD:DAT</sub>	2.7 V ≤ EV <sub>DD</sub> ≤ 5.5 V		0	0.9	0	0.9	–	–	0	0.9	μs
		1.9 V ≤ EV <sub>DD</sub> ≤ 5.5 V		0	0.9	0	0.9	–	–	0	0.9	μs
Setup time of stop condition	t <sub>SU:STO</sub>	2.7 V ≤ EV <sub>DD</sub> ≤ 5.5 V		0.6		0.6		–	–	0.6		μs
		1.9 V ≤ EV <sub>DD</sub> ≤ 5.5 V		0.6		0.6		–	–	0.6		μs
Bus-free time	t <sub>BUF</sub>	2.7 V ≤ EV <sub>DD</sub> ≤ 5.5 V		1.3		1.3		–	–	1.3		μs
		1.9 V ≤ EV <sub>DD</sub> ≤ 5.5 V		1.3		1.3		–	–	1.3		μs

- Notes**
- The first clock pulse is generated after this period when the start/restart condition is detected.
  - The maximum value (MAX.) of t<sub>HD:DAT</sub> is during normal transfer and a clock stretch state is inserted in the ACK (acknowledge) timing.
  - Either V<sub>DD</sub> or V<sub>BAT</sub> is selected by the battery backup function.

**Remark** The maximum value of C<sub>b</sub> (communication line capacitance) and the value of R<sub>b</sub> (communication line pull-up resistor) at that time in each mode are as follows.

Fast mode: C<sub>b</sub> = 320 pF, R<sub>b</sub> = 1.1 kΩ

(3) I<sup>2</sup>C fast mode plus

(T<sub>A</sub> = -40 to +85°C, 2.7 V ≤ EV<sub>DD0</sub> = EV<sub>DD1</sub> ≤ V<sub>DD</sub><sup>Note 3</sup> ≤ 5.5 V, V<sub>SS</sub> = EV<sub>SS0</sub> = EV<sub>SS1</sub> = 0 V)

Parameter	Symbol	Conditions	HS (high-speed main) Mode		LS (low-speed main) Mode		LP (low-power main) Mode		LV (low-voltage main) Mode		Unit
			MIN.	MAX.	MIN.	MAX.	MIN.	MAX.	MIN.	MAX.	
SCLA0 clock frequency	f <sub>SCL</sub>	Fast mode plus: f <sub>CLK</sub> ≥ 10 MHz 2.7 V ≤ EV <sub>DD</sub> ≤ 5.5 V	0	1000	-	-	-	-	-	-	kHz
Setup time of restart condition	t <sub>SU:STA</sub>	2.7 V ≤ EV <sub>DD</sub> ≤ 5.5 V	0.26		-	-	-	-	-	-	μs
Hold time <sup>Note 1</sup>	t <sub>HD:STA</sub>	2.7 V ≤ EV <sub>DD</sub> ≤ 5.5 V	0.26		-	-	-	-	-	-	μs
Hold time when SCLA0 = "L"	t <sub>LOW</sub>	2.7 V ≤ EV <sub>DD</sub> ≤ 5.5 V	0.5		-	-	-	-	-	-	μs
Hold time when SCLA0 = "H"	t <sub>HIGH</sub>	2.7 V ≤ EV <sub>DD</sub> ≤ 5.5 V	0.26		-	-	-	-	-	-	μs
Data setup time (reception)	t <sub>SU:DAT</sub>	2.7 V ≤ EV <sub>DD</sub> ≤ 5.5 V	50		-	-	-	-	-	-	ns
Data hold time (transmission) <sup>Note 2</sup>	t <sub>HD:DAT</sub>	2.7 V ≤ EV <sub>DD</sub> ≤ 5.5 V	0	0.5	-	-	-	-	-	-	μs
Setup time of stop condition	t <sub>SU:STO</sub>	2.7 V ≤ EV <sub>DD</sub> ≤ 5.5 V	0.26		-	-	-	-	-	-	μs
Bus-free time	t <sub>BUF</sub>	2.7 V ≤ EV <sub>DD</sub> ≤ 5.5 V	0.5		-	-	-	-	-	-	μs

- Notes**
1. The first clock pulse is generated after this period when the start/restart condition is detected.
  2. The maximum value (MAX.) of t<sub>HD:DAT</sub> is during normal transfer and a clock stretch state is inserted in the ACK (acknowledge) timing.
  3. Either V<sub>DD</sub> or V<sub>BAT</sub> is selected by the battery backup function.

**Remark** The maximum value of C<sub>b</sub> (communication line capacitance) and the value of R<sub>b</sub> (communication line pull-up resistor) at that time in each mode are as follows.

Fast mode plus: C<sub>b</sub> = 120 pF, R<sub>b</sub> = 1.1 kΩ

I<sup>2</sup>C serial transfer timing

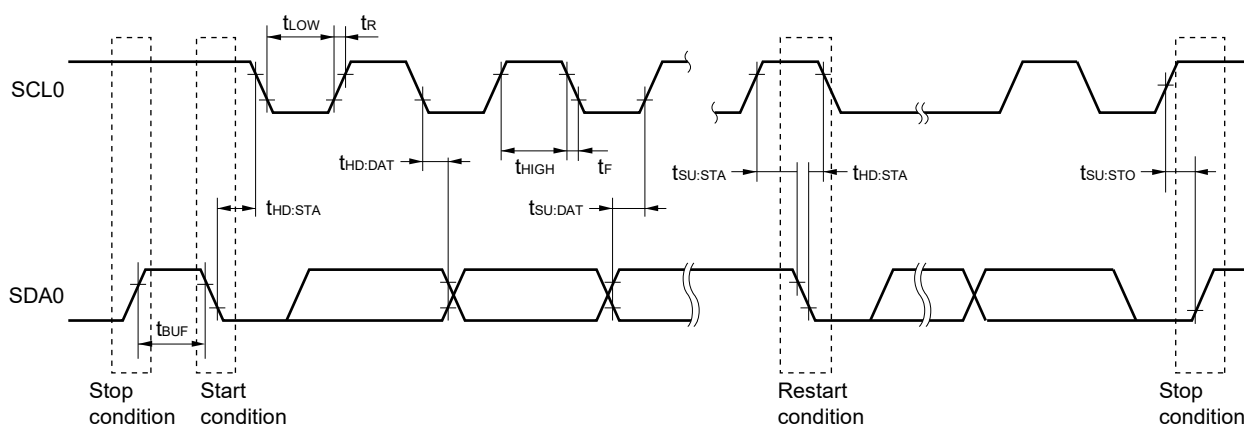

## 2.6 Analog Characteristics

### 2.6.1 A/D converter characteristics

(1) When reference voltage (+) =  $AV_{REFP}/ANI0$  (ADREFP1 = 0, ADREFP0 = 1), reference voltage (−) =  $AV_{REFM}/ANI1$  (ADREFM = 1), target pins: ANI2 to ANI5 and internal reference voltage

( $T_A = -40$  to  $+85^\circ\text{C}$ ,  $1.9\text{ V} \leq V_{DD}^{\text{Note 3}} \leq 5.5\text{ V}$ ,  $V_{SS} = 0\text{ V}$ , reference voltage (+) =  $AV_{REFP}$ , reference voltage (−) =  $AV_{REFM} = 0\text{ V}$ )

Parameter	Symbol	Conditions		MIN.	TYP.	MAX.	Unit
Resolution	RES			8		10	bit
Overall error <sup>Note 1</sup>	AINL	10-bit resolution $AV_{REFP} = V_{DD}$	$1.9\text{ V} \leq AV_{REFP} \leq 5.5\text{ V}$		1.2	$\pm 5.0$	LSB
Conversion time	$t_{CONV}$	10-bit resolution	$3.6\text{ V} \leq V_{DD} \leq 5.5\text{ V}$	2.125		39	$\mu\text{s}$
			$2.7\text{ V} \leq V_{DD} \leq 5.5\text{ V}$	3.1875		39	$\mu\text{s}$
			$1.9\text{ V} \leq V_{DD} \leq 5.5\text{ V}$	17		39	$\mu\text{s}$
Zero-scale error <sup>Notes 1, 2</sup>	$E_{ZS}$	10-bit resolution $AV_{REFP} = V_{DD}$	$1.9\text{ V} \leq AV_{REFP} \leq 5.5\text{ V}$			$\pm 0.35$	%FSR
Full-scale error <sup>Notes 1, 2</sup>	$E_{FS}$	10-bit resolution $AV_{REFP} = V_{DD}$	$1.9\text{ V} \leq AV_{REFP} \leq 5.5\text{ V}$			$\pm 0.35$	%FSR
Integral linearity error <sup>Note 1</sup>	ILE	10-bit resolution $AV_{REFP} = V_{DD}$	$1.9\text{ V} \leq AV_{REFP} \leq 5.5\text{ V}$			$\pm 3.5$	LSB
Differential linearity error <sup>Note 1</sup>	DLE	10-bit resolution $AV_{REFP} = V_{DD}$	$1.9\text{ V} \leq AV_{REFP} \leq 5.5\text{ V}$			$\pm 2.0$	LSB
Reference voltage (+)	$AV_{REFP}$			1.9		$V_{DD}$	V
Analog input voltage	$V_{AIN}$			0		$AV_{REFP}$	V
	$V_{BGR}$	Select internal reference voltage output $2.4\text{ V} \leq V_{DD} \leq 5.5\text{ V}$ , HS (high-speed main) mode		1.38	1.45	1.5	V

**Notes** 1. Excludes quantization error ( $\pm 1/2$  LSB).

2. This value is indicated as a ratio (%FSR) to the full-scale value.

3. Either  $V_{DD}$  or  $V_{BAT}$  is selected by the battery backup function.

(2) When reference voltage (+) =  $V_{DD}$  (ADREFP1 = 0, ADREFP0 = 0), reference voltage (-) =  $V_{SS}$  (ADREFM = 0), target pins: ANI0 to ANI5 and internal reference voltage

( $T_A = -40$  to  $+85^\circ\text{C}$ ,  $1.9\text{ V} \leq V_{DD}^{\text{Note 3}} \leq 5.5\text{ V}$ ,  $V_{SS} = 0\text{ V}$ , reference voltage (+) =  $V_{DD}^{\text{Note 3}}$ , reference voltage (-) =  $V_{SS}$ )

Parameter	Symbol	Conditions		MIN.	TYP.	MAX.	Unit
Resolution	RES			8		10	bit
Overall error <sup>Note 1</sup>	AINL	10-bit resolution	$1.9\text{ V} \leq V_{DD} \leq 5.5\text{ V}$		1.2	$\pm 10.5$	LSB
Conversion time	$t_{\text{CONV}}$	10-bit resolution	$3.6\text{ V} \leq V_{DD} \leq 5.5\text{ V}$	2.125		39	$\mu\text{s}$
			$2.7\text{ V} \leq V_{DD} \leq 5.5\text{ V}$	3.1875		39	$\mu\text{s}$
			$1.9\text{ V} \leq V_{DD} \leq 5.5\text{ V}$	17		39	$\mu\text{s}$
Zero-scale error <sup>Notes 1, 2</sup>	$E_{\text{ZS}}$	10-bit resolution	$1.9\text{ V} \leq V_{DD} \leq 5.5\text{ V}$			$\pm 0.85$	%FSR
Full-scale error <sup>Notes 1, 2</sup>	$E_{\text{FS}}$	10-bit resolution	$1.9\text{ V} \leq V_{DD} \leq 5.5\text{ V}$			$\pm 0.85$	%FSR
Integral linearity error <sup>Note 1</sup>	ILE	10-bit resolution	$1.9\text{ V} \leq V_{DD} \leq 5.5\text{ V}$			$\pm 4.0$	LSB
Differential linearity error <sup>Note 1</sup>	DLE	10-bit resolution	$1.9\text{ V} \leq V_{DD} \leq 5.5\text{ V}$			$\pm 2.0$	LSB
Analog input voltage	$V_{\text{AIN}}$			0		$V_{\text{DD}}$	V
	$V_{\text{BGR}}$	Select internal reference voltage output, $2.4\text{ V} \leq V_{\text{DD}} \leq 5.5\text{ V}$ , HS (high-speed main) mode		1.38	1.45	1.5	V

- Notes**
1. Excludes quantization error ( $\pm 1/2$  LSB).
  2. This value is indicated as a ratio (%FSR) to the full-scale value.
  3. Either  $V_{\text{DD}}$  or  $V_{\text{BAT}}$  is selected by the battery backup function.

**Caution** When using reference voltage (+) =  $V_{\text{DD}}$ , taking into account the voltage drop due to the effect of the power switching circuit of the battery backup function and use the A/D conversion result. In addition, enter HALT mode during A/D conversion and set  $V_{\text{DD}}$  port to input.

(3) When reference voltage (+) = Internal reference voltage (ADREFP1 = 1, ADREFP0 = 0), reference voltage (-) =  $AV_{\text{REFM}}/\text{ANI1}$  (ADREFM = 1), target pins: ANI0, ANI2 to ANI5

( $T_A = -40$  to  $+85^\circ\text{C}$ ,  $2.4\text{ V} \leq V_{\text{DD}}^{\text{Note 3}} \leq 5.5\text{ V}$ ,  $V_{\text{SS}} = 0\text{ V}$ , reference voltage (+) =  $V_{\text{BGR}}$ , reference voltage (-) =  $AV_{\text{REFM}} = 0\text{ V}$ , HS (high-speed main) mode)

Parameter	Symbol	Conditions		MIN.	TYP.	MAX.	Unit
Resolution	RES			8			bit
Conversion time	$t_{\text{CONV}}$	8-bit resolution	$2.4\text{ V} \leq V_{\text{DD}} \leq 5.5\text{ V}$	17		39	$\mu\text{s}$
Zero-scale error <sup>Notes 1, 2</sup>	$E_{\text{ZS}}$	8-bit resolution	$2.4\text{ V} \leq V_{\text{DD}} \leq 5.5\text{ V}$			$\pm 0.60$	%FSR
Integral linearity error <sup>Note 1</sup>	ILE	8-bit resolution	$2.4\text{ V} \leq V_{\text{DD}} \leq 5.5\text{ V}$			$\pm 2.0$	LSB
Differential linearity error <sup>Note 1</sup>	DLE	8-bit resolution	$2.4\text{ V} \leq V_{\text{DD}} \leq 5.5\text{ V}$			$\pm 1.0$	LSB
Reference voltage (+)	$V_{\text{BGR}}$			1.38	1.45	1.5	V
Analog input voltage	$V_{\text{AIN}}$			0		$V_{\text{BGR}}$	V

- Notes**
1. Excludes quantization error ( $\pm 1/2$  LSB).
  2. This value is indicated as a ratio (%FSR) to the full-scale value.
  3. Either  $V_{\text{DD}}$  or  $V_{\text{BAT}}$  is selected by the battery backup function.

2.6.2 24-bit ΔΣ A/D converter characteristics

(1) Reference voltage

( $T_A = -40$  to  $+85^\circ\text{C}$ ,  $2.4\text{ V} \leq V_{DD}^{\text{Note 1}} \leq 5.5\text{ V}$ ,  $V_{SS} = AV_{SS} = 0\text{ V}$ )

Parameter	Symbol	Conditions	MIN.	TYP.	MAX.	Unit
Internal reference voltage	$V_{AVRTO}$			0.8		V
Temperature coefficient for internal reference voltage <small>Note 2</small>	$TC_{BOX}$	0.47 μF capacitor connected to AREGC, AVRT, and AVCM pins		10		ppm/°C

- Notes**
1. Either  $V_{DD}$  or  $V_{BAT}$  is selected by the battery backup function.
  2. This is as stipulated by the BOX method.

$$TC_{BOX} = \frac{1}{V_{min}} \cdot \frac{V_{max} - V_{min}}{\Delta T_a}$$

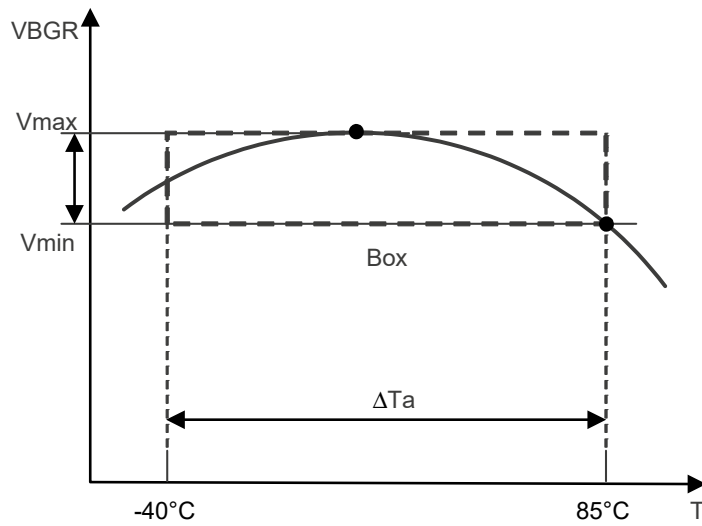

## (2) Analog input

(T<sub>A</sub> = -40 to +85°C, 2.4 V ≤ V<sub>DD</sub><sup>Note</sup> ≤ 5.5 V, V<sub>SS</sub> = AV<sub>SS</sub> = 0 V)

Parameter	Symbol	Conditions	MIN.	TYP.	MAX.	Unit
Input voltage range (differential voltage)	V <sub>AIN</sub>	x1 gain	-500		500	mV
		x2 gain	-250		250	
		x4 gain	-125		125	
		x8 gain	-62.5		62.5	
		x16 gain	-31.25		31.25	
		x32 gain	-15.625		15.625	
Input gain	ainGAIN	x1 gain		1		Times
		x2 gain		2		
		x4 gain		4		
		x8 gain		8		
		x16 gain		16		
		x32 gain		32		
Input impedance	ainRIN	Differential voltage	150	360		kΩ
		Single-ended voltage	100	240		

**Note** Either V<sub>DD</sub> or V<sub>BAT</sub> is selected by the battery backup function.



## (3) 4 kHz sampling mode

(T<sub>A</sub> = -40 to +85°C, 2.4 V ≤ V<sub>DD</sub><sup>Note</sup> ≤ 5.5 V, V<sub>SS</sub> = AV<sub>SS</sub> = 0 V)

Parameter	Symbol	Conditions	MIN.	TYP.	MAX.	Unit
Operation clock	f <sub>DSAD</sub>	f <sub>x</sub> oscillation clock, input external clock or high-speed on-chip oscillator clock is used		12		MHz
Sampling frequency	f <sub>s</sub>			3906.25		Hz
Oversampling frequency	f <sub>OS</sub>			1.5		MHz
Output data rate	T <sub>DATA</sub>			256		μs
Data width	RES			24		bit
SNDR	SNDR	x1 gain High-speed system clock is selected as operating clock of 24-bit ΔΣ A/D converter (bit 0 of PCKC register (DSADCK) = 1)		80		dB
		x16 gain High-speed system clock is selected as operating clock of 24-bit ΔΣ A/D converter (bit 0 of PCKC register (DSADCK) = 1)	69	74		
		x32 gain High-speed system clock is selected as operating clock of 24-bit ΔΣ A/D converter (bit 0 of PCKC register (DSADCK) = 1)	65	69		
Passband (low pass band)	f <sub>Chpf</sub>	At -3 dB (phase in high pass filter not adjusted) Bits 7 and 6 of DSADHPFCR register (DSADCOF1, DSADCOF0) = 00		0.607		Hz
		At -3 dB (phase in high pass filter not adjusted) Bits 7 and 6 of DSADHPFCR register (DSADCOF1, DSADCOF0) = 01		1.214		Hz
		At -3 dB (phase in high pass filter not adjusted) Bits 7 and 6 of DSADHPFCR register (DSADCOF1, DSADCOF0) = 10		2.429		Hz
		At -3 dB (phase in high pass filter not adjusted) Bits 7 and 6 of DSADHPFCR register (DSADCOF1, DSADCOF0) = 11		4.857		Hz
In-band ripple 1	rp1	45 Hz to 55 Hz @50 Hz 54 Hz to 66 Hz @60 Hz	-0.01		0.01	dB
In-band ripple 2	rp2	45 Hz to 275 Hz @50 Hz 54 Hz to 330 Hz @60 Hz	-0.1		0.1	
In-band ripple 3	rp3	45 Hz to 1100 Hz @50 Hz 54 Hz to 1320 Hz @60 Hz	-0.1		0.1	
Passband (high pass band)	f <sub>Cipf</sub>	-3 dB		1672		Hz
Stopband (high pass band)	f <sub>att</sub>	-80 dB		2545		Hz
Out-band attenuation	ATT1	f <sub>s</sub>	-80			dB
	ATT2	2 f <sub>s</sub>	-80			dB

**Note** Either V<sub>DD</sub> or V<sub>BAT</sub> is selected by the battery backup function.

## (4) 2 kHz sampling mode

(T<sub>A</sub> = -40 to +85°C, 2.4 V ≤ V<sub>DD</sub><sup>Note</sup> ≤ 5.5 V, V<sub>SS</sub> = AV<sub>SS</sub> = 0 V)

Parameter	Symbol	Conditions	MIN.	TYP.	MAX.	Unit
Operation clock	f <sub>DSAD</sub>	f <sub>x</sub> oscillation clock, input external clock or high-speed on-chip oscillator clock is used		12		MHz
Sampling frequency	f <sub>s</sub>			1953.125		Hz
Oversampling frequency	f <sub>OS</sub>			0.75		MHz
Output data rate	T <sub>DATA</sub>			512		μs
Data width	RES			24		bit
SNDR	SNDR	x1 gain High-speed system clock is selected as operating clock of 24-bit ΔΣ A/D converter (bit 0 of PCKC register (DSADCK) = 1)		80		dB
		x16 gain High-speed system clock is selected as operating clock of 24-bit ΔΣ A/D converter (bit 0 of PCKC register (DSADCK) = 1)	69	74		
		x32 gain High-speed system clock is selected as operating clock of 24-bit ΔΣ A/D converter (bit 0 of PCKC register (DSADCK) = 1)	65	69		
Passband (low pass band)	f <sub>Chpf</sub>	At -3 dB (phase in high pass filter not adjusted)		0.303		Hz
In-band ripple 1	rp1	45 Hz to 55 Hz @50 Hz 54 Hz to 66 Hz @60 Hz	-0.01		0.01	dB
In-band ripple 2	rp2	45 Hz to 275 Hz @50 Hz 54 Hz to 330 Hz @60 Hz	-0.1		0.1	
In-band ripple 3	rp3	45 Hz to 660 Hz @50 Hz 54 Hz to 550 Hz @60 Hz	-0.1		0.1	
Passband (high pass band)	f <sub>Cipf</sub>	-3 dB		836		Hz
Stopband (high pass band)	f <sub>att</sub>	-80 dB		1273		Hz
Out-band attenuation	ATT1	f <sub>s</sub>	-80			dB
	ATT2	2 f <sub>s</sub>	-80			dB

**Note** Either V<sub>DD</sub> or V<sub>BAT</sub> is selected by the battery backup function.

## 2.6.3 Temperature sensor 2 characteristics

(T<sub>A</sub> = -40 to +85°C, 2.4 V ≤ V<sub>DD</sub><sup>Note 2</sup> ≤ 5.5 V, V<sub>SS</sub> = 0 V, HS (high-speed main) mode)

Parameter	Symbol	Conditions	MIN.	TYP.	MAX.	Unit
Temperature sensor 2 output voltage	V <sub>OUT</sub>			0.67		V
Temperature coefficient	F <sub>VTMPS2</sub>	Temperature sensor that depends on the temperature	-11.7	-10.7	-9.7	mV/°C
Operation stabilization wait time <sup>Note 1</sup>	t <sub>TMPO</sub>	Operable		15	50	μs
	t <sub>TMPC</sub>	Switching mode		5	15	μs

**Notes** 1. Time to drop to output stable value ±5LSB (±7 mV) or less.2. Either V<sub>DD</sub> or V<sub>BAT</sub> is selected by the battery backup function.

### 2.6.4 POR circuit characteristics

( $T_A = -40$  to  $+85^\circ\text{C}$ ,  $V_{SS} = 0$  V)

Parameter	Symbol	Conditions	MIN.	TYP.	MAX.	Unit
Detection voltage	$V_{POR}$	When power supply rises <sup>Note 1</sup>	1.47	1.51	1.55	V
	$V_{PDR}$	When power supply falls <sup>Note 2</sup>	1.46	1.50	1.54	V

- Notes 1.** Be sure to maintain the reset state until the power supply voltage rises over the minimum  $V_{DD}$  value in the operating voltage range specified in **2.4 AC Characteristics**, by using the voltage detector or external reset pin.
- 2.** If the power supply voltage falls while the voltage detector is off, be sure to either shift to STOP mode or execute a reset by using the voltage detector or external reset pin before the power supply voltage falls below the minimum operating voltage specified in **2.4 AC Characteristics**.

### 2.6.5 LVD circuit characteristics

#### LVD Detection Voltage of Reset Mode and Interrupt Mode

( $T_A = -40$  to  $+85^\circ\text{C}$ ,  $V_{PDR} \leq V_{DD}^{\text{Note}}$   $\leq 5.5$  V,  $V_{SS} = 0$  V)

Parameter	Symbol	Conditions	MIN.	TYP.	MAX.	Unit
Detection voltage	$V_{LVD0}$	When power supply rises	3.98	4.06	4.24	V
		When power supply falls	3.90	3.98	4.16	V
	$V_{LVD1}$	When power supply rises	3.68	3.75	3.92	V
		When power supply falls	3.60	3.67	3.84	V
	$V_{LVD2}$	When power supply rises	3.07	3.13	3.29	V
		When power supply falls	3.00	3.06	3.22	V
	$V_{LVD3}$	When power supply rises	2.96	3.02	3.18	V
		When power supply falls	2.90	2.96	3.12	V
	$V_{LVD4}$	When power supply rises	2.86	2.92	3.07	V
		When power supply falls	2.80	2.86	3.01	V
	$V_{LVD5}$	When power supply rises	2.76	2.81	2.97	V
		When power supply falls	2.70	2.75	2.91	V
	$V_{LVD6}$	When power supply rises	2.66	2.71	2.86	V
		When power supply falls	2.60	2.65	2.80	V
	$V_{LVD7}$	When power supply rises	2.56	2.61	2.76	V
		When power supply falls	2.50	2.55	2.70	V
	$V_{LVD8}$	When power supply rises	2.45	2.50	2.65	V
		When power supply falls	2.40	2.45	2.60	V
	$V_{LVD9}$	When power supply rises	2.05	2.09	2.23	V
		When power supply falls	2.00	2.04	2.18	V
	$V_{LVD10}$	When power supply rises	1.94	1.98	2.12	V
		When power supply falls	1.90	1.94	2.08	V
	$V_{LVD11}$	When power supply rises	1.84	1.88	2.01	V
		When power supply falls	1.80	1.84	1.97	V
$V_{LVD12}$	When power supply rises	1.74	1.77	1.81	V	
	When power supply falls	1.70	1.73	1.77	V	
Minimum pulse width	$t_{LW}$		300			$\mu\text{s}$
Detection delay time					300	$\mu\text{s}$

**Note** Either  $V_{DD}$  or  $V_{BAT}$  is selected by the battery backup function.

**LVD Detection Voltage of Interrupt & Reset Mode****(T<sub>A</sub> = -40 to +85°C, V<sub>PDR</sub> ≤ V<sub>DD</sub><sup>Note</sup> ≤ 5.5 V, V<sub>SS</sub> = 0 V)**

Parameter	Symbol	Conditions	MIN.	TYP.	MAX.	Unit	
Detection voltage	V <sub>LVD8</sub>	VPOC2, VPOC1, VPOC0 = 0, 0, 1, falling reset voltage: 1.8 V	1.80	1.84	1.97	V	
	V <sub>LVD7</sub>	LVIS1, LVIS0 = 1, 0 (+0.1 V)	Rising release reset voltage	1.94	1.98	2.12	V
			Falling interrupt voltage	1.90	1.94	2.08	V
	V <sub>LVD6</sub>	LVIS1, LVIS0 = 0, 1 (+0.2 V)	Rising release reset voltage	2.05	2.09	2.23	V
			Falling interrupt voltage	2.00	2.04	2.18	V
	V <sub>LVD1</sub>	LVIS1, LVIS0 = 0, 0 (+1.2 V)	Rising release reset voltage	3.07	3.13	3.29	V
			Falling interrupt voltage	3.00	3.06	3.22	V
	V <sub>LVD8</sub>	VPOC2, VPOC1, VPOC0 = 0, 1, 0, falling reset voltage	2.40	2.45	2.60	V	
	V <sub>LVD7</sub>	LVIS1, LVIS0 = 1, 0	Rising release reset voltage	2.56	2.61	2.76	V
			Falling interrupt voltage	2.50	2.55	2.70	V
	V <sub>LVD6</sub>	LVIS1, LVIS0 = 0, 1	Rising release reset voltage	2.66	2.71	2.86	V
			Falling interrupt voltage	2.60	2.65	2.80	V
	V <sub>LVD1</sub>	LVIS1, LVIS0 = 0, 0	Rising release reset voltage	3.68	3.75	3.92	V
			Falling interrupt voltage	3.60	3.67	3.84	V
	V <sub>LVD5</sub>	VPOC2, VPOC1, VPOC0 = 0, 1, 1, falling reset voltage	2.70	2.75	2.91	V	
	V <sub>LVD4</sub>	LVIS1, LVIS0 = 1, 0	Rising release reset voltage	2.86	2.92	3.07	V
			Falling interrupt voltage	2.80	2.86	3.01	V
	V <sub>LVD3</sub>	LVIS1, LVIS0 = 0, 1	Rising release reset voltage	2.96	3.02	3.18	V
			Falling interrupt voltage	2.90	2.96	3.12	V
	V <sub>LVD0</sub>	LVIS1, LVIS0 = 0, 0	Rising release reset voltage	3.98	4.06	4.24	V
Falling interrupt voltage			3.90	3.98	4.16	V	

**Note** Either V<sub>DD</sub> or V<sub>BAT</sub> is selected by the battery backup function.**2.6.6 Power supply voltage rising slope characteristics****(T<sub>A</sub> = -40 to +85°C, V<sub>SS</sub> = 0 V)**

Parameter	Symbol	Conditions	MIN.	TYP.	MAX.	Unit
Power supply voltage rising slope	S <sub>VDDR</sub>				54	V/ms
	S <sub>VRTCR</sub>					

**Caution** Make sure to keep the internal reset state by the LVD circuit or an external reset until V<sub>DD</sub> reaches the operating voltage range shown in 2.4 AC Characteristics.

2.7 Battery Backup Function

2.7.1 Power supply switching characteristics

( $T_A = -40$  to  $+85^\circ\text{C}$ ,  $V_{SS} = 0$  V)

Parameter	Symbol	Conditions	MIN.	TYP.	MAX.	Unit
Power switching detection voltage	$V_{DET\text{BAT}1}$	$V_{DD} \rightarrow V_{BAT}$ $V_{BAT} \leq 3.6$ V	2.09	2.18	2.26	V
	$V_{DET\text{BAT}2}$	$V_{BAT} \rightarrow V_{DD}$ $V_{BAT} \leq 3.6$ V	2.19	2.28	2.36	V
$V_{DD}$ fall slope	$SV_{DDF}$		-0.06			V/ms
Response time of power switch detector	$t_{cmp}$	$V_{BAT} \leq 3.6$ V			500	$\mu\text{s}$

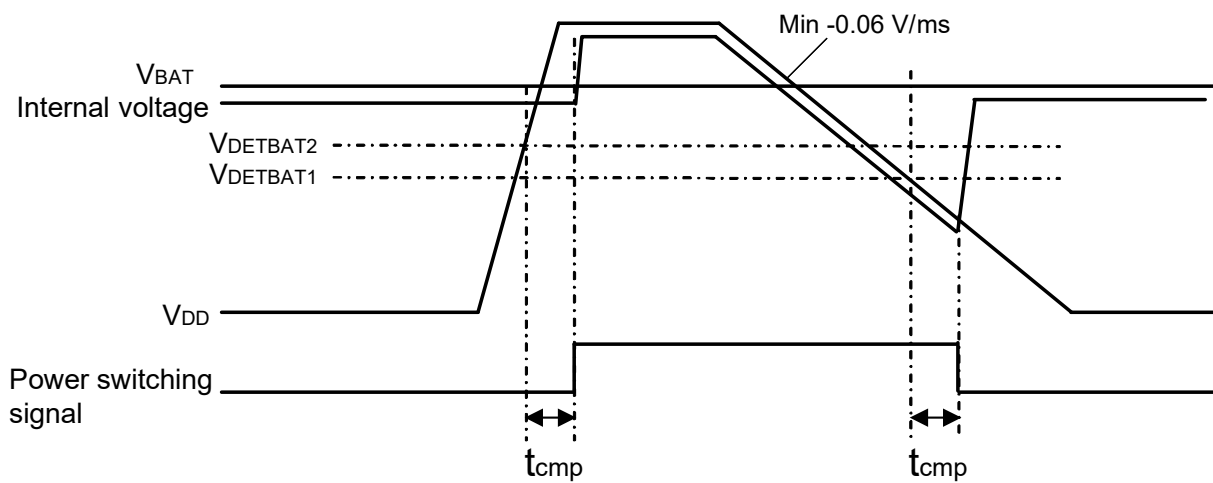

2.7.2 V<sub>DD</sub> pin voltage detection characteristics

(T<sub>A</sub> = -40 to +85°C, 1.9 V ≤ V<sub>DD</sub><sup>Note</sup> ≤ 5.5 V, V<sub>SS</sub> = 0 V)

Parameter	Symbol	LVDVDD[2:0]	Conditions	MIN.	TYP.	MAX.	Unit
Detection voltage	V <sub>LVDVDD0</sub>	000	Rising	2.40	2.53	2.65	V
			Falling	2.33	2.46	2.58	V
	V <sub>LVDVDD1</sub>	001	Rising	2.60	2.74	2.86	V
			Falling	2.53	2.67	2.79	V
	V <sub>LVDVDD2</sub>	010	Rising	2.79	2.94	3.07	V
			Falling	2.73	2.87	2.99	V
	V <sub>LVDVDD3</sub>	011	Rising	3.00	3.15	3.28	V
			Falling	2.93	3.08	3.21	V
V <sub>LVDVDD4</sub>	100	Rising	3.30	3.46	3.60	V	
		Falling	3.23	3.39	3.52	V	
V <sub>LVDVDD5</sub>	101	Rising	3.59	3.77	3.91	V	
		Falling	3.53	3.70	3.84	V	
Minimum pulse width	t <sub>pw_lvdvdd</sub>	–	–	300			μs
Detection delay time	t <sub>dly_lvdvdd</sub>	–	–			300	μs

**Note** Either V<sub>DD</sub> or V<sub>BAT</sub> is selected by the battery backup function.

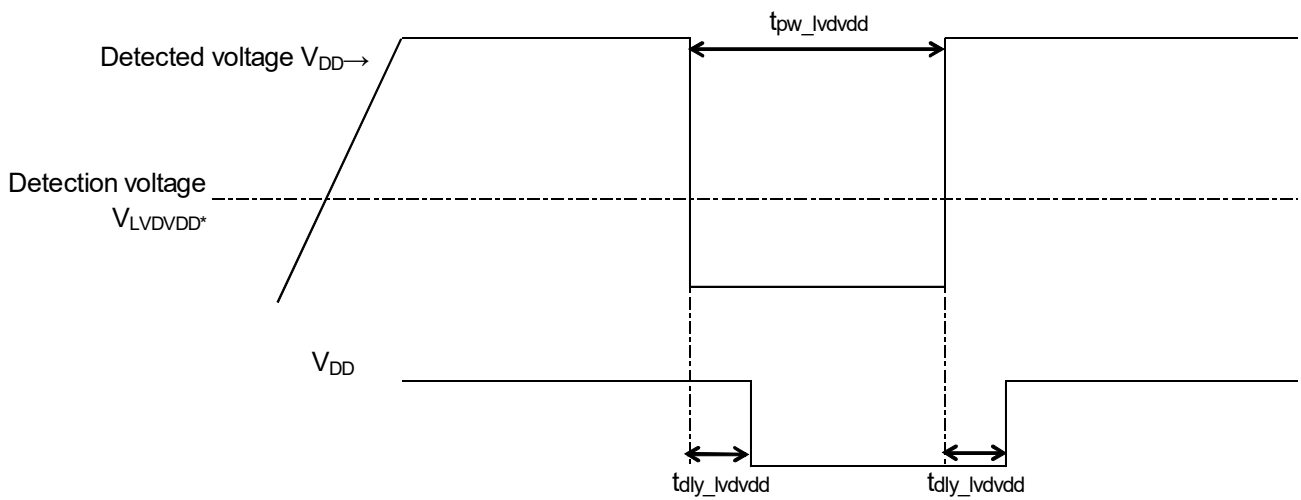

2.7.3 VBAT pin voltage detection characteristics

( $T_A = -40$  to  $+85^\circ\text{C}$ ,  $1.9\text{ V} \leq V_{DD}^{\text{Note}} \leq 5.5\text{ V}$ ,  $V_{SS} = 0\text{ V}$ )

Parameter	Symbol	LVDVBAT[2:0]	Conditions	MIN.	TYP.	MAX.	Unit
Detection voltage	V <sub>LVDVBAT0</sub>	000	Rising	1.99	2.11	2.22	V
			Falling	1.94	2.05	2.16	V
	V <sub>LVDVBAT1</sub>	001	Rising	2.09	2.21	2.32	V
			Falling	2.03	2.15	2.26	V
	V <sub>LVDVBAT2</sub>	010	Rising	2.20	2.32	2.43	V
			Falling	2.14	2.26	2.37	V
	V <sub>LVDVBAT3</sub>	011	Rising	2.29	2.42	2.53	V
			Falling	2.23	2.36	2.47	V
	V <sub>LVDVBAT4</sub>	100	Rising	2.38	2.52	2.64	V
			Falling	2.33	2.46	2.58	V
	V <sub>LVDVBAT5</sub>	101	Rising	2.48	2.62	2.74	V
			Falling	2.42	2.56	2.68	V
V <sub>LVDVBAT6</sub>	110	Rising	2.59	2.73	2.86	V	
		Falling	2.53	2.67	2.79	V	
Minimum pulse width	t <sub>pw_lvdvbat</sub>	–	–	300			μs
Detection delay time	t <sub>dly_lvdvbat</sub>	–	–			300	μs

**Note** Either V<sub>DD</sub> or V<sub>BAT</sub> is selected by the battery backup function.

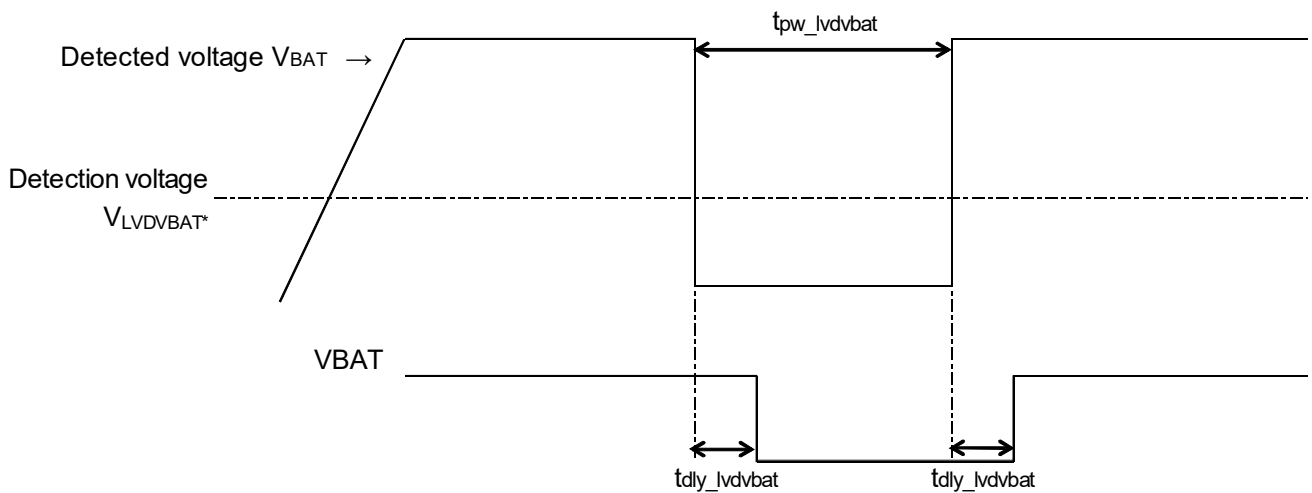

2.7.4 VRTC pin voltage detection characteristics

( $T_A = -40$  to  $+85^\circ\text{C}$ ,  $1.9\text{ V} \leq V_{DD}^{\text{Note}} \leq 5.5\text{ V}$ ,  $V_{SS} = 0\text{ V}$ )

Parameter	Symbol	LVDVRTC[1:0]	Conditions	MIN.	TYP.	MAX.	Unit
Detection voltage	$V_{LVDVRTC0}$	00	Rising	2.16	2.22	2.28	V
			Falling	2.10	2.16	2.22	V
	$V_{LVDVRTC1}$	01	Rising	2.36	2.43	2.50	V
			Falling	2.30	2.37	2.44	V
	$V_{LVDVRTC2}$	10	Rising	2.56	2.63	2.70	V
			Falling	2.50	2.57	2.64	V
	$V_{LVDVRTC3}$	11	Rising	2.76	2.84	2.92	V
			Falling	2.70	2.78	2.86	V
Minimum pulse width	$t_{pw\_lvdvrtc}$	—	—	300			$\mu\text{s}$
Detection delay time	$t_{dly\_lvdvrtc}$	—	—			300	$\mu\text{s}$

**Note** Either  $V_{DD}$  or  $V_{BAT}$  is selected by the battery backup function.

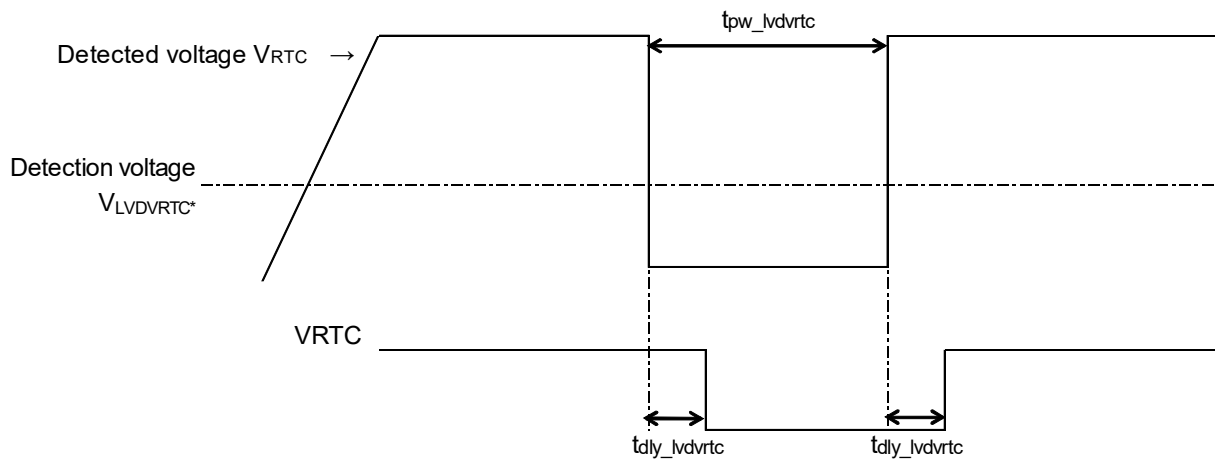



2.7.5 EXLVD pin voltage detection

( $T_A = -40$  to  $+85^\circ\text{C}$ ,  $1.9\text{ V} \leq V_{DD}^{\text{Note}} \leq 5.5\text{ V}$ ,  $V_{SS} = 0\text{ V}$ )

Parameter	Symbol	Conditions	MIN.	TYP.	MAX.	Unit
Detection voltage	$V_{LVDEXLVD}$	Rising	1.25	1.33	1.41	V
		Falling	1.20	1.28	1.36	V
Minimum pulse width	$t_{pw\_lvdexlvd}$	–	300			$\mu\text{s}$
Detection delay time	$t_{dly\_lvdexlvd}$	–			300	$\mu\text{s}$
Pin resistor	$r_{in\_extlvd}$	LVDEXLVDEN = 1		34		$\text{M}\Omega$

**Note** Either  $V_{DD}$  or  $V_{BAT}$  is selected by the battery backup function.

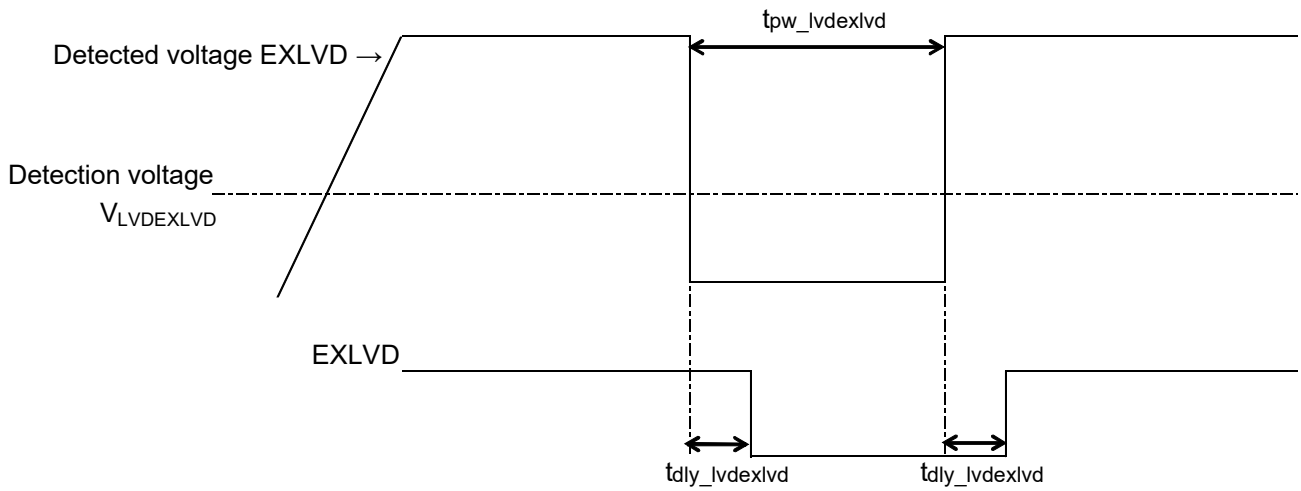

## 2.8 LCD Characteristics

### 2.8.1 Resistance division method

#### (1) Static display mode

( $T_A = -40$  to  $+85^\circ\text{C}$ ,  $V_{L4} (\text{MIN.}) \leq EV_{DD0} = EV_{DD1} \leq V_{DD}^{\text{Note}} \leq 5.5 \text{ V}$ ,  $V_{SS} = EV_{SS0} = EV_{SS1} = 0 \text{ V}$ )

Parameter	Symbol	Conditions	MIN.	TYP.	MAX.	Unit
LCD drive voltage	$V_{L4}$		2.0		$V_{DD}^{\text{Note}}$	V

**Note** Either  $V_{DD}$  or  $V_{BAT}$  is selected by the battery backup function.

#### (2) 1/2 bias method, 1/4 bias method

( $T_A = -40$  to  $+85^\circ\text{C}$ ,  $V_{L4} (\text{MIN.}) \leq EV_{DD0} = EV_{DD1} \leq V_{DD}^{\text{Note}} \leq 5.5 \text{ V}$ ,  $V_{SS} = EV_{SS0} = EV_{SS1} = 0 \text{ V}$ )

Parameter	Symbol	Conditions	MIN.	TYP.	MAX.	Unit
LCD drive voltage	$V_{L4}$		2.7		$V_{DD}^{\text{Note}}$	V

**Note** Either  $V_{DD}$  or  $V_{BAT}$  is selected by the battery backup function.

#### (3) 1/3 bias method

( $T_A = -40$  to  $+85^\circ\text{C}$ ,  $V_{L4} (\text{MIN.}) \leq EV_{DD0} = EV_{DD1} \leq V_{DD}^{\text{Note}} \leq 5.5 \text{ V}$ ,  $V_{SS} = EV_{SS0} = EV_{SS1} = 0 \text{ V}$ )

Parameter	Symbol	Conditions	MIN.	TYP.	MAX.	Unit
LCD drive voltage	$V_{L4}$		2.5		$V_{DD}^{\text{Note}}$	V

**Note** Either  $V_{DD}$  or  $V_{BAT}$  is selected by the battery backup function.

## 2.8.2 Internal voltage boosting method

## (1) 1/3 bias method

(TA = -40 to +85°C, 1.7 V ≤ EVDD0 = EVDD1 ≤ VDD<sup>Note 4</sup> ≤ 5.5 V, VSS = EVSS0 = EVSS1 = 0 V)

Parameter	Symbol	Conditions	MIN.	TYP.	MAX.	Unit	
LCD output voltage variation range	VL1	C1 to C4 <sup>Note 1</sup> = 0.47 μF	VLCD = 04H	0.90	1.00	1.08	V
			VLCD = 05H	0.95	1.05	1.13	V
			VLCD = 06H	1.00	1.10	1.18	V
			VLCD = 07H	1.05	1.15	1.23	V
			VLCD = 08H	1.10	1.20	1.28	V
			VLCD = 09H	1.15	1.25	1.33	V
			VLCD = 0AH	1.20	1.30	1.38	V
			VLCD = 0BH	1.25	1.35	1.43	V
			VLCD = 0CH	1.30	1.40	1.48	V
			VLCD = 0DH	1.35	1.45	1.53	V
			VLCD = 0EH	1.40	1.50	1.58	V
			VLCD = 0FH	1.45	1.55	1.63	V
			VLCD = 10H	1.50	1.60	1.68	V
			VLCD = 11H	1.55	1.65	1.73	V
VLCD = 12H	1.60	1.70	1.78	V			
VLCD = 13H	1.65	1.75	1.83	V			
Doubler output voltage	VL2	C1 to C4 <sup>Note 1</sup> = 0.47 μF	2 VL1-0.10	2 VL1	2 VL1	V	
Tripler output voltage	VL4	C1 to C4 <sup>Note 1</sup> = 0.47 μF	3 VL1-0.15	3 VL1	3 VL1	V	
Reference voltage setup time <sup>Note 2</sup>	t <sub>VWAIT1</sub>		5			ms	
Voltage boost wait time <sup>Note 3</sup>	t <sub>VWAIT2</sub>	C1 to C4 <sup>Note 1</sup> = 0.47 μF	500			ms	

**Notes** 1. This is a capacitor that is connected between voltage pins used to drive the LCD.

C1: A capacitor connected between CAPH and CAPL

C2: A capacitor connected between VL1 and GND

C3: A capacitor connected between VL2 and GND

C4: A capacitor connected between VL4 and GND

C1 = C2 = C3 = C4 = 0.47 μF±30%

2. This is the time required to wait from when the reference voltage is specified by using the VLCD register (or when the internal voltage boosting method is selected (by setting the MDSET1 and MDSET0 bits of the LCDM0 register to 01B) if the default value reference voltage is used) until voltage boosting starts (VLCON = 1).
3. This is the wait time from when voltage boosting is started (VLCON = 1) until display is enabled (LCDON = 1).
4. Either VDD or VBAT is selected by the battery backup function.

**(2) 1/4 bias method****( $T_A = -40$  to  $+85^\circ\text{C}$ ,  $1.7\text{ V} \leq \text{EVDD0} = \text{EVDD1} \leq \text{VDD}^{\text{Note 4}} \leq 5.5\text{ V}$ ,  $\text{VSS} = \text{EVSS0} = \text{EVSS1} = 0\text{ V}$ )**

Parameter	Symbol	Conditions	MIN.	TYP.	MAX.	Unit	
LCD output voltage variation range	VL1	C1 to C5 <sup>Note 1</sup> = 0.47 $\mu\text{F}$	VLCD = 04H	0.90	1.00	1.08	V
			VLCD = 05H	0.95	1.05	1.13	V
			VLCD = 06H	1.00	1.10	1.18	V
			VLCD = 07H	1.05	1.15	1.23	V
			VLCD = 08H	1.10	1.20	1.28	V
			VLCD = 09H	1.15	1.25	1.33	V
			VLCD = 0AH	1.20	1.30	1.38	V
Doubler output voltage	VL2	C1 to C5 <sup>Note 1</sup> = 0.47 $\mu\text{F}$	$2 V_{L1} - 0.08$	$2 V_{L1}$	$2 V_{L1}$	V	
Tripler output voltage	VL3	C1 to C5 <sup>Note 1</sup> = 0.47 $\mu\text{F}$	$3 V_{L1} - 0.12$	$3 V_{L1}$	$3 V_{L1}$	V	
Quadruply output voltage	VL4	C1 to C5 <sup>Note 1</sup> = 0.47 $\mu\text{F}$	$4 V_{L1} - 0.16$	$4 V_{L1}$	$4 V_{L1}$	V	
Reference voltage setup time <sup>Note 2</sup>	$t_{\text{VWAIT1}}$		5			ms	
Voltage boost wait time <sup>Note 3</sup>	$t_{\text{VWAIT2}}$	C1 to C5 <sup>Note 1</sup> = 0.47 $\mu\text{F}$	500			ms	

**Notes** 1. This is a capacitor that is connected between voltage pins used to drive the LCD.

C1: A capacitor connected between CAPH and CAPL

C2: A capacitor connected between VL1 and GND

C3: A capacitor connected between VL2 and GND

C4: A capacitor connected between VL3 and GND

C5: A capacitor connected between VL4 and GND

$C1 = C2 = C3 = C4 = C5 = 0.47\ \mu\text{F} \pm 30\%$

2. This is the time required to wait from when the reference voltage is specified by using the VLCD register (or when the internal voltage boosting method is selected (by setting the MDSET1 and MDSET0 bits of the LCDM0 register to 01B) if the default value reference voltage is used) until voltage boosting starts (VLCON = 1).
3. This is the wait time from when voltage boosting is started (VLCON = 1) until display is enabled (LCDON = 1).
4. Either VDD or VBAT is selected by the battery backup function.

### 2.8.3 Capacitor split method

#### (1) 1/3 bias method

( $T_A = -40$  to  $+85^\circ\text{C}$ ,  $2.2\text{ V} \leq V_{DD0} = V_{DD1} \leq V_{DD}^{\text{Note 3}} \leq 5.5\text{ V}$ ,  $V_{SS} = V_{SS0} = V_{SS1} = 0\text{ V}$ )

Parameter	Symbol	Conditions	MIN.	TYP.	MAX.	Unit
$V_{L4}$ voltage	$V_{L4}$	$C1$ to $C4 = 0.47\ \mu\text{F}^{\text{Note 2}}$		$V_{DD}^{\text{Note 3}}$		V
$V_{L2}$ voltage	$V_{L2}$	$C1$ to $C4 = 0.47\ \mu\text{F}^{\text{Note 2}}$	$2/3 V_{L4} - 0.1$	$2/3 V_{L4}$	$2/3 V_{L4} + 0.1$	V
$V_{L1}$ voltage	$V_{L1}$	$C1$ to $C4 = 0.47\ \mu\text{F}^{\text{Note 2}}$	$1/3 V_{L4} - 0.1$	$1/3 V_{L4}$	$1/3 V_{L4} + 0.1$	V
Capacitor split wait time <sup>Note 1</sup>	$t_{\text{WAIT}}$		100			ms

- Notes**
- This is the wait time from when voltage bucking is started ( $V_{LCON} = 1$ ) until display is enabled ( $V_{LCDON} = 1$ ).
  - This is a capacitor that is connected between voltage pins used to drive the LCD.  
 $C1$ : A capacitor connected between  $CAPH$  and  $CAPL$   
 $C2$ : A capacitor connected between  $V_{L1}$  and GND  
 $C3$ : A capacitor connected between  $V_{L2}$  and GND  
 $C4$ : A capacitor connected between  $V_{L4}$  and GND  
 $C1 = C2 = C3 = C4 = 0.47\ \mu\text{F} \pm 30\%$
  - Either  $V_{DD}$  or  $V_{BAT}$  is selected by the battery backup function.

### 2.9 RAM Data Retention Characteristics

( $T_A = -40$  to  $+85^\circ\text{C}$ )

Parameter	Symbol	Conditions	MIN.	TYP.	MAX.	Unit
Data retention supply voltage	$V_{DDDR}$		1.46 <sup>Note</sup>		5.5	V

**Note** The value depends on the POR detection voltage. When the voltage drops, the data in RAM are retained until a POR is applied, but are not retained following a POR.

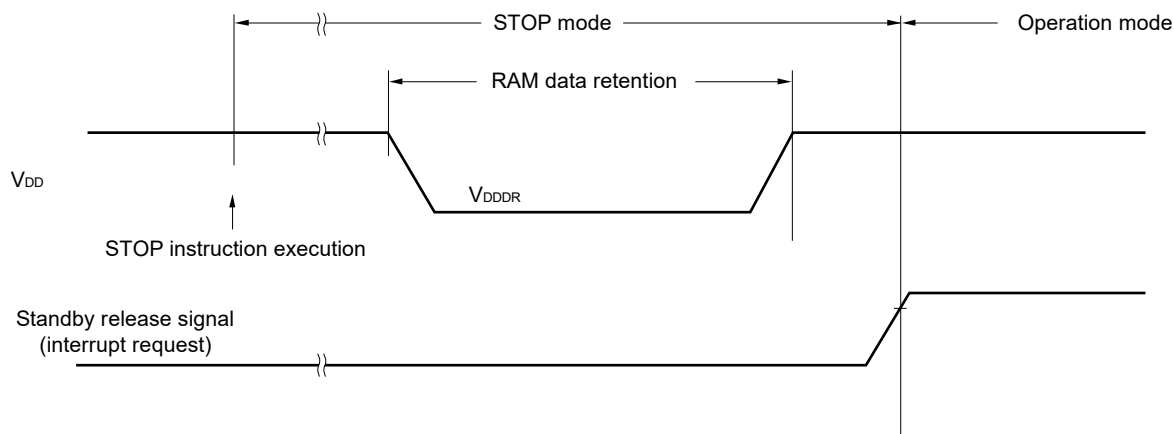

### 2.10 Flash Memory Programming Characteristics

( $T_A = -40$  to  $+85^\circ\text{C}$ ,  $1.9\text{ V} \leq V_{DD}^{\text{Note 4}} \leq 5.5\text{ V}$ ,  $V_{SS} = 0\text{ V}$ )

Parameter	Symbol	Conditions	MIN.	TYP.	MAX.	Unit
System clock frequency	$f_{CLK}$	$1.9\text{ V} \leq V_{DD}^{\text{Note 4}} \leq 5.5\text{ V}$	1		24	MHz
Number of code flash rewrites <sup>Notes 1, 2, 3</sup>	$C_{erwr}$	Retained for 20 years $T_A = 85^\circ\text{C}$	1,000			Times
Number of data flash rewrites <sup>Notes 1, 2, 3</sup>		Retained for 1 year $T_A = 25^\circ\text{C}$		1,000,000		
		Retained for 5 years $T_A = 85^\circ\text{C}$	100,000			
		Retained for 20 years $T_A = 85^\circ\text{C}$	10,000			

- Notes**
- 1 erase + 1 write after the erase is regarded as 1 rewrite. The retaining years are until next rewrite after the rewrite.
  2. When using flash memory programmer and Renesas Electronics self programming library
  3. This characteristic indicates the flash memory characteristic and based on Renesas Electronics reliability test.
  4. Either  $V_{DD}$  or  $V_{BAT}$  is selected by the battery backup function.

### 2.11 Dedicated Flash Memory Programmer Communication (UART)

( $T_A = -40$  to  $+85^\circ\text{C}$ ,  $1.9\text{ V} \leq EV_{DD0} = EV_{DD1} \leq V_{DD}^{\text{Note}} \leq 5.5\text{ V}$ ,  $V_{SS} = EV_{SS0} = EV_{SS1} = 0\text{ V}$ )

Parameter	Symbol	Conditions	MIN.	TYP.	MAX.	Unit
Transfer rate		During serial programming	115,200		1,000,000	bps

**Note** Either  $V_{DD}$  or  $V_{BAT}$  is selected by the battery backup function.

2.12 Timing Specs for Switching Flash Memory Programming Modes

( $T_A = -40$  to  $+85^\circ\text{C}$ ,  $1.9\text{ V} \leq \text{EVDD0} = \text{EVDD1} \leq \text{VDD}^{\text{Note}} \leq 5.5\text{ V}$ ,  $\text{VSS} = \text{EVSS0} = \text{EVSS1} = 0\text{ V}$ )

Parameter	Symbol	Conditions	MIN.	TYP.	MAX.	Unit
Time to complete the communication for the initial setting after the external reset is released	$t_{\text{SUNIT}}$	POR and LVD reset must be released before the external reset is released.			100	ms
Time to release the external reset after the TOOL0 pin is set to the low level	$t_{\text{SU}}$	POR and LVD reset must be released before the external reset is released.	10			$\mu\text{s}$
Time to hold the TOOL0 pin at the low level after the external reset is released (excluding the processing time of the firmware to control the flash memory)	$t_{\text{HD}}$	POR and LVD reset must be released before the external reset is released.	1			ms

**Note** Either VDD or VBAT is selected by the battery backup function.

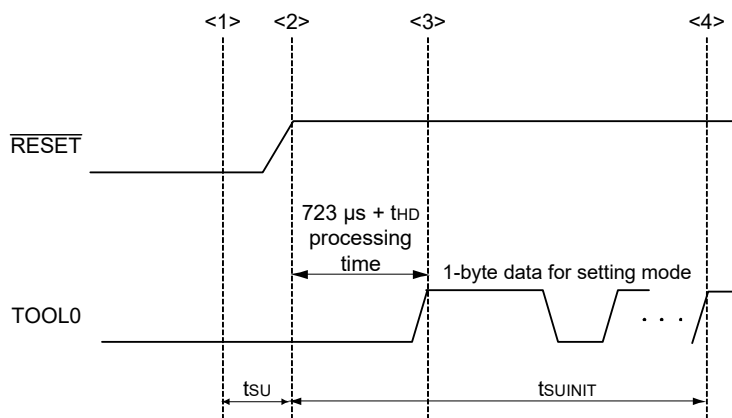

- <1> The low level is input to the TOOL0 pin.
- <2> The external reset is released (POR and LVD reset must be released before the external reset is released.).
- <3> The TOOL0 pin is set to the high level.
- <4> Setting of the flash memory programming mode by UART reception and complete the baud rate setting.

**Remark**  $t_{\text{SUNIT}}$ : The segment shows that it is necessary to finish specifying the initial communication settings within 100 ms from when the resets end.

$t_{\text{SU}}$ : Time to release the external reset after the TOOL0 pin is set to the low level.

$t_{\text{HD}}$ : Time to hold the TOOL0 pin at the low level after the external reset is released (excluding the processing time of the firmware to control the flash memory)

### 3. PACKAGE DRAWINGS

#### 3.1 64-pin Products

R5F10NLEDFB, R5F10NLGDFB, R5F11TLEDFB, R5F11TLGDFB

<R>

JEITA Package Code	RENESAS Code	Previous Code	MASS[Typ.]
P-LFQFP64-10x10-0.50	PLQP0064KB-C	—	0.3g

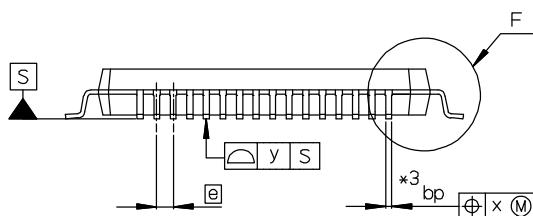
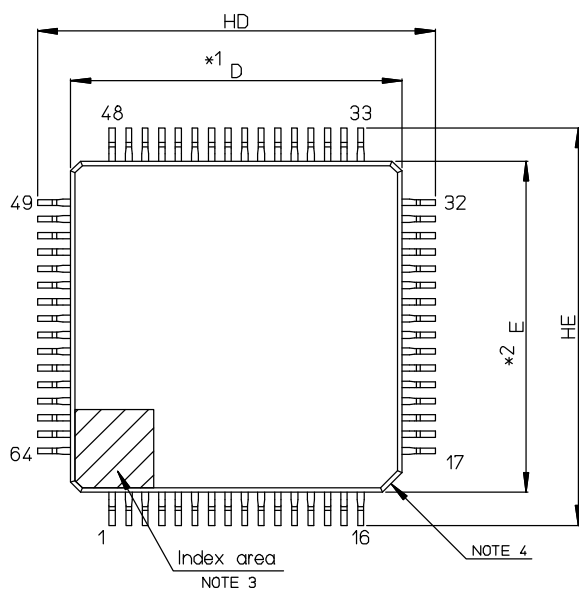

- NOTE)
1. DIMENSIONS \*1\* AND \*2\* DO NOT INCLUDE MOLD FLASH.
  2. DIMENSION \*3\* DOES NOT INCLUDE TRIM OFFSET.
  3. PIN 1 VISUAL INDEX FEATURE MAY VARY, BUT MUST BE LOCATED WITHIN THE HATCHED AREA.
  4. CHAMFERS AT CORNERS ARE OPTIONAL; SIZE MAY VARY.

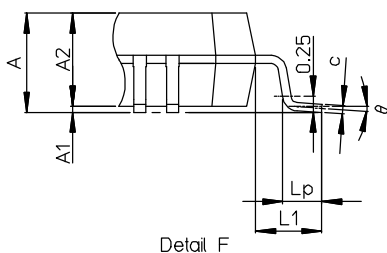

Reference Symbol	Dimension in Millimeters		
	Min	Nom	Max
D	9.9	10.0	10.1
E	9.9	10.0	10.1
A2	—	1.4	—
HD	11.8	12.0	12.2
HE	11.8	12.0	12.2
A	—	—	1.7
A1	0.05	—	0.15
bp	0.15	0.20	0.27
c	0.09	—	0.20
θ	0°	3.5°	8°
[e]	—	0.5	—
x	—	—	0.08
y	—	—	0.08
Lp	0.45	0.6	0.75
L1	—	1.0	—



<R>

JEITA Package code	RENESAS code	MASS(TYP.)[g]
P-LFQFP064-10x10-0.50	PLQP0064KL-A	0.36

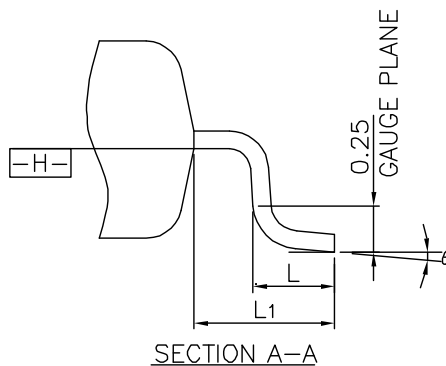
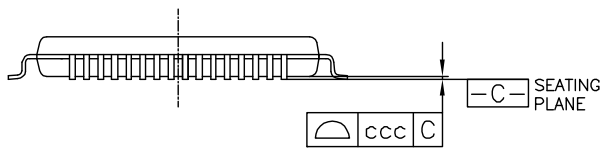
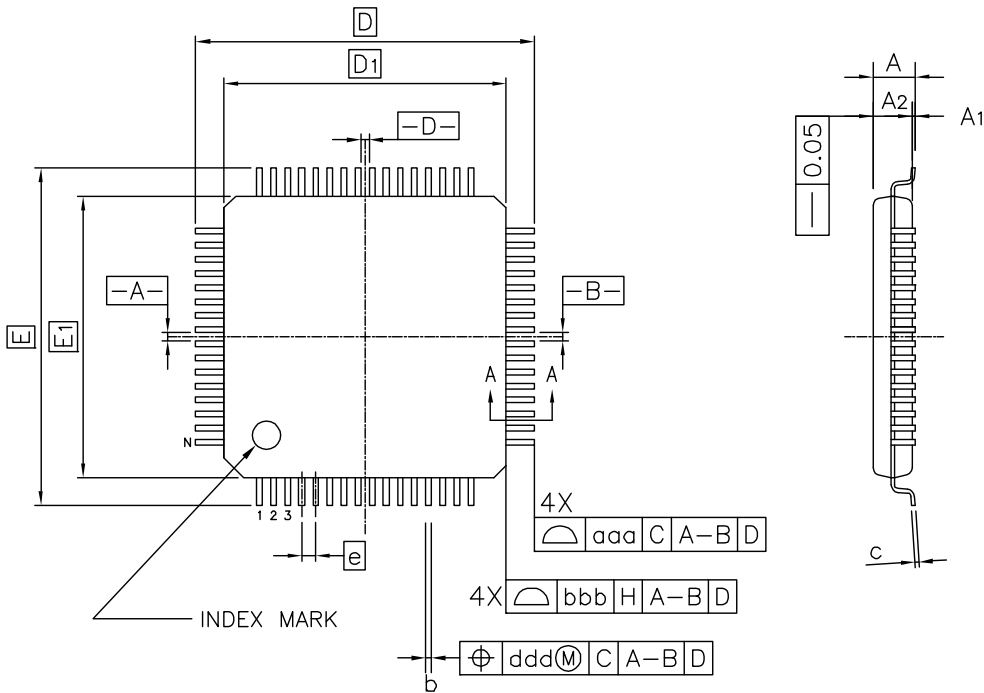

Reference Symbol	Dimension in Millimeters		
	Min.	Nom.	Max.
A	-	-	1.60
A <sub>1</sub>	0.05	-	0.15
A <sub>2</sub>	1.35	1.40	1.45
D	-	12.00	-
D <sub>1</sub>	-	10.00	-
E	-	12.00	-
E <sub>1</sub>	-	10.00	-
N	-	64	-
e	-	0.50	-
b	0.17	0.22	0.27
c	0.09	-	0.20
θ	0°	3.5°	7°
L	0.45	0.60	0.75
L <sub>1</sub>	-	1.00	-
aaa	-	-	0.20
bbb	-	-	0.20
ccc	-	-	0.08
ddd	-	-	0.08

3.2 80-pin Products

R5F10NMEDFB, R5F10NMGDFB, R5F10NMJDFB

<R>

JEITA Package Code	RENESAS Code	Previous Code	MASS (Typ) [g]
P-LFQFP80-12x12-0.50	PLQP0080KB-B	—	0.5

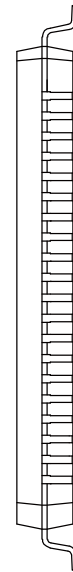
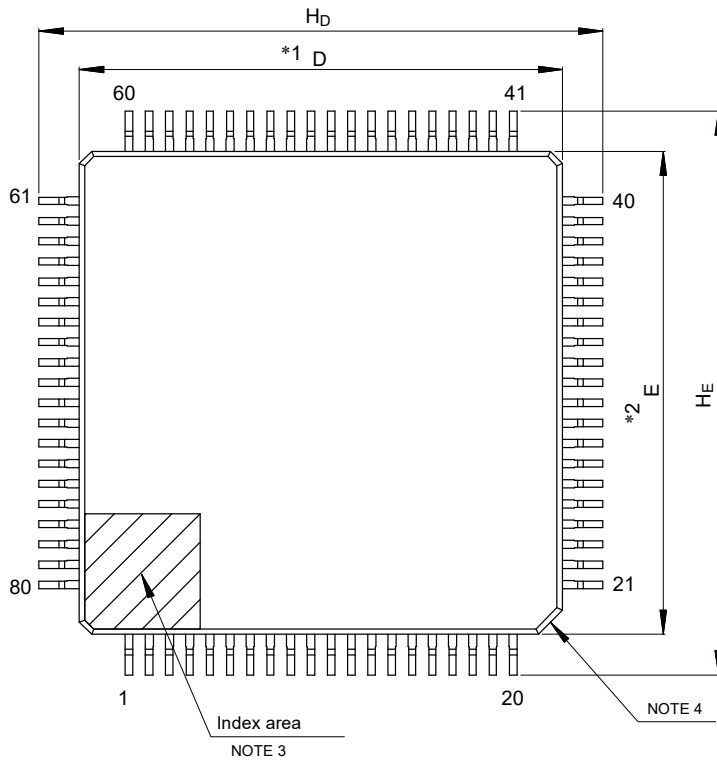

- NOTE)
1. DIMENSIONS \*\*1" AND \*\*2" DO NOT INCLUDE MOLD FLASH.
  2. DIMENSION \*\*3" DOES NOT INCLUDE TRIM OFFSET.
  3. PIN 1 VISUAL INDEX FEATURE MAY VARY, BUT MUST BE LOCATED WITHIN THE HATCHED AREA.
  4. CHAMFERS AT CORNERS ARE OPTIONAL, SIZE MAY VARY.

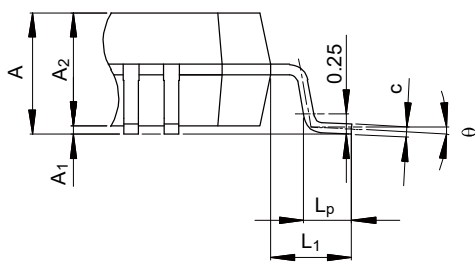
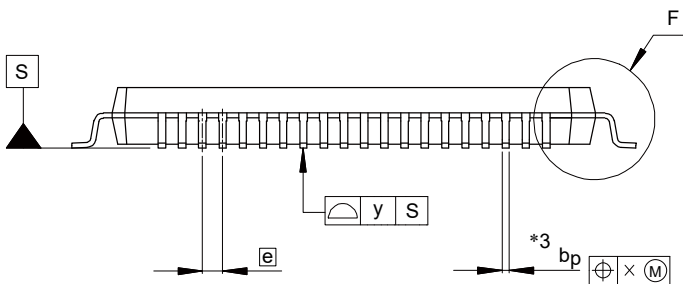

Detail F

Reference Symbol	Dimensions in millimeters		
	Min	Nom	Max
D	11.9	12.0	12.1
E	11.9	12.0	12.1
A <sub>2</sub>	—	1.4	—
H <sub>D</sub>	13.8	14.0	14.2
H <sub>E</sub>	13.8	14.0	14.2
A	—	—	1.7
A <sub>1</sub>	0.05	—	0.15
b <sub>p</sub>	0.15	0.20	0.27
c	0.09	—	0.20
θ	0°	3.5°	8°
e	—	0.5	—
x	—	—	0.08
y	—	—	0.08
L <sub>p</sub>	0.45	0.6	0.75
L <sub>1</sub>	—	1.0	—

<R>

JEITA Package code	RENESAS code	MASS(TYP.)[g]
P-LFQFP80-12x12-0.50	PLQP0080KJ-A	0.49

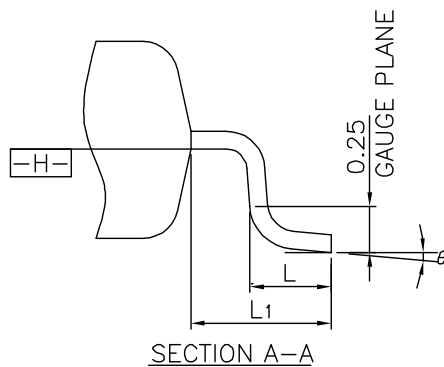
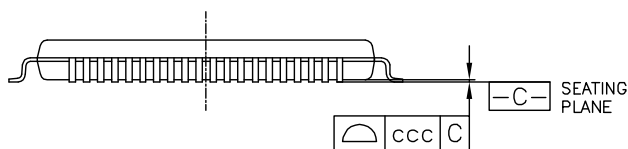
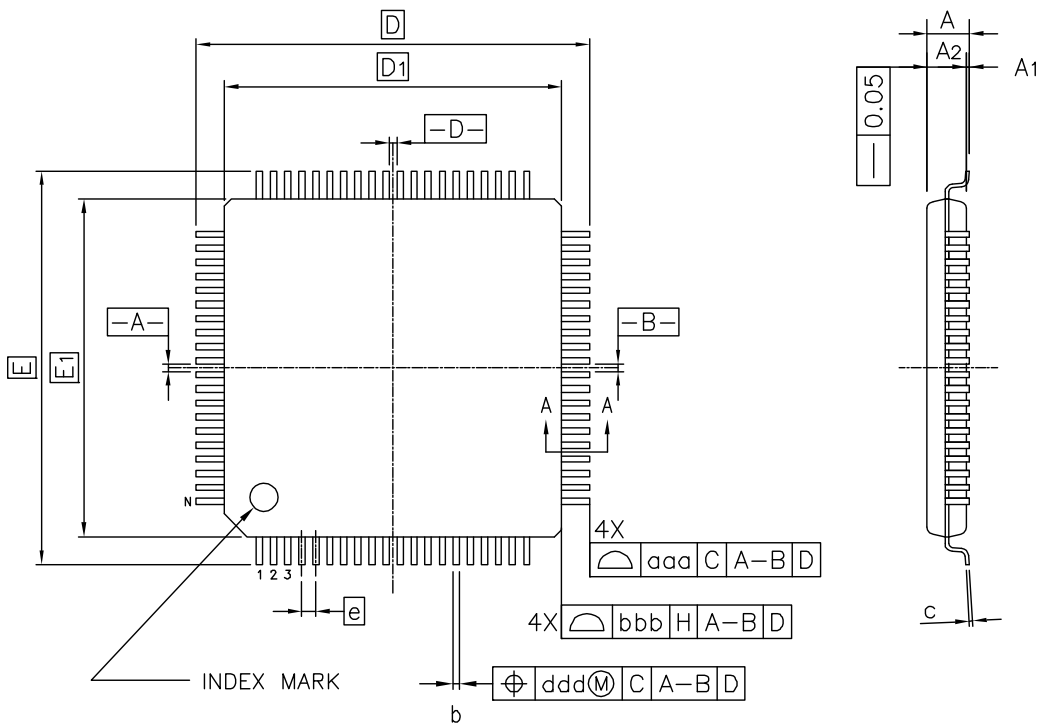

Reference Symbol	Dimension in Millimeters		
	Min.	Nom.	Max.
A	—	—	1.60
A <sub>1</sub>	0.05	—	0.15
A <sub>2</sub>	1.35	1.40	1.45
D	—	14.00	—
D <sub>1</sub>	—	12.00	—
E	—	14.00	—
E <sub>1</sub>	—	12.00	—
N	—	80	—
e	—	0.50	—
b	0.17	0.22	0.27
c	0.09	—	0.20
$\theta$	0°	3.5°	7°
L	0.45	0.60	0.75
L <sub>1</sub>	—	1.00	—
aaa	—	—	0.20
bbb	—	—	0.20
ccc	—	—	0.08
ddd	—	—	0.08

3.3 100-pin Products

R5F10NPJDFB, R5F10NPGDFB

<R>

JEITA Package Code	RENESAS Code	Previous Code	MASS[Typ.]
P-LFQFP100-14x14-0.50	PLQP0100KB-B	—	0.6g

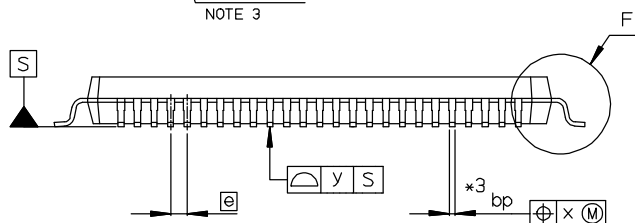
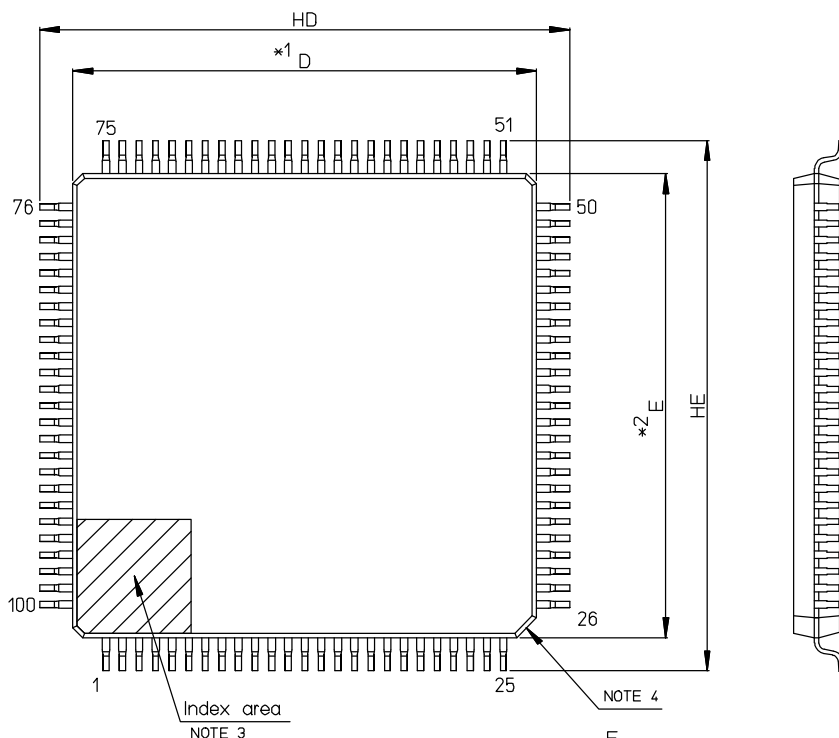

- NOTE)
1. DIMENSIONS \*1\* AND \*2\* DO NOT INCLUDE MOLD FLASH.
  2. DIMENSION \*3\* DOES NOT INCLUDE TRIM OFFSET.
  3. PIN 1 VISUAL INDEX FEATURE MAY VARY, BUT MUST BE LOCATED WITHIN THE HATCHED AREA.
  4. CHAMFERS AT CORNERS ARE OPTIONAL; SIZE MAY VARY.

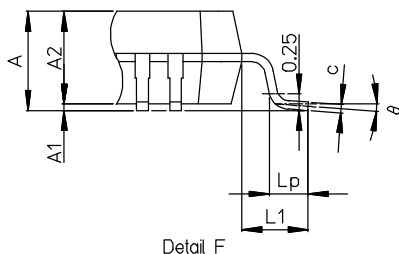

Reference Symbol	Dimension in Millimeters		
	Min	Nom	Max
D	13.9	14.0	14.1
E	13.9	14.0	14.1
A2	—	1.4	—
HD	15.8	16.0	16.2
HE	15.8	16.0	16.2
A	—	—	1.7
A1	0.05	—	0.15
bp	0.15	0.20	0.27
c	0.09	—	0.20
$\theta$	0°	3.5°	8°
e	—	0.5	—
x	—	—	0.08
y	—	—	0.08
Lp	0.45	0.6	0.75
L1	—	1.0	—

<R>

JEITA Package code	RENESAS code	MASS(TYP.)[g]
P-LFQFP100-14x14-0.50	PLQP0100KP-A	0.67

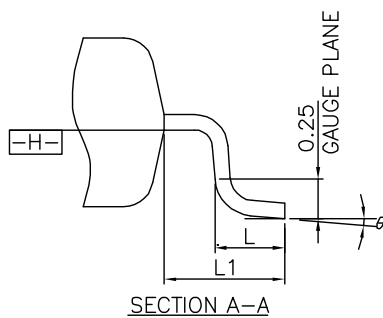
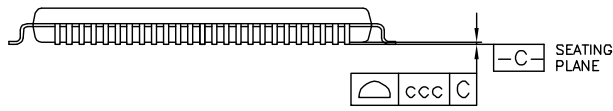
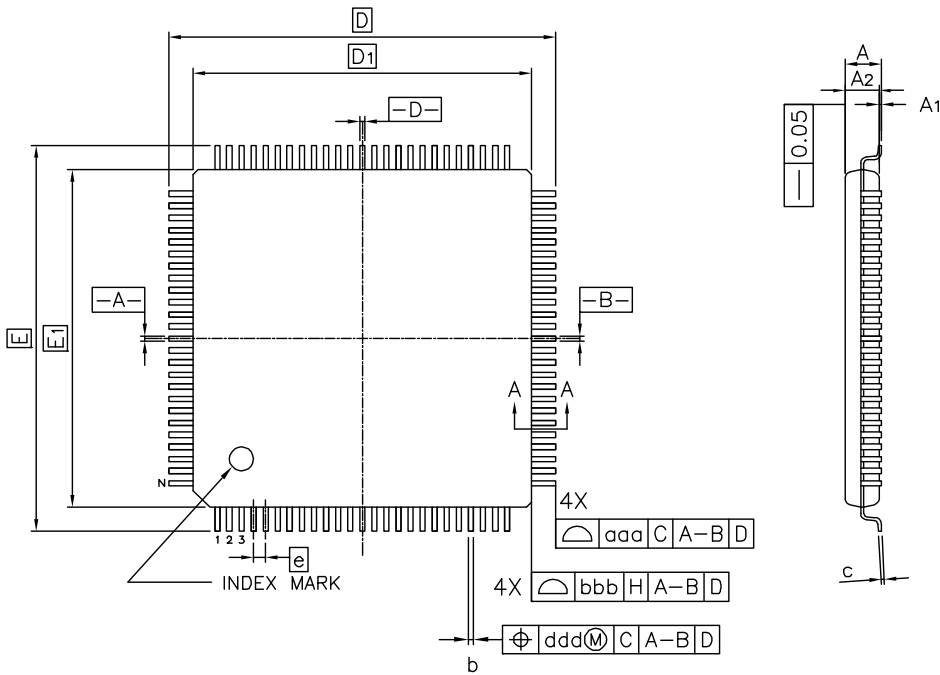

Reference Symbol	Dimension in Millimeters		
	Min.	Nom.	Max.
A	-	-	1.60
A <sub>1</sub>	0.05	-	0.15
A <sub>2</sub>	1.35	1.40	1.45
D	-	16.00	-
D <sub>1</sub>	-	14.00	-
E	-	16.00	-
E <sub>1</sub>	-	14.00	-
N	-	100	-
e	-	0.50	-
b	0.17	0.22	0.27
c	0.09	-	0.20
θ	0°	3.5°	7°
L	0.45	0.60	0.75
L <sub>1</sub>	-	1.00	-
aaa	-	-	0.20
bbb	-	-	0.20
ccc	-	-	0.08
ddd	-	-	0.08

<b>Revision History</b>	<b>RL78/I1C Datasheet</b>
-------------------------	---------------------------

Rev.	Date	Description	
		Page	Summary
1.00	May 31, 2016	–	First Edition issued
2.00	Aug 31, 2018	p.12	Modification of table in 1.6 Outline of Functions
		p.21, 22	Modification of description in 2.3.1 Pin characteristics
		p.67	Modification of table in 2.6.1 (1) When reference voltage (+) = $AV_{REFP}/ANI0$ (ADREFP1 = 0, ADREFP0 = 1), reference voltage (-) = $AV_{REFM}/ANI1$ (ADREFM = 1), target pins: ANI2 to ANI5 and internal reference voltage
		p.68	Modification of table in 2.6.1 (2) When reference voltage (+) = $V_{DD}$ (ADREFP1 = 0, ADREFP0 = 0), reference voltage (-) = $V_{SS}$ (ADREFM = 0), target pins: ANI0 to ANI5 and internal reference voltage
		p.69	Modification of parameter and symbol, and addition of note 2 in 2.6.2 (1) Reference voltage
		p.70	Modification of condition and unit in 2.6.2 (2) Analog input
		p.72	Modification of typical value in 2.6.2 (4) 2 kHz sampling mode
2.10	Aug 23, 2019	Throughout	Addition of products in which AES function is not available (R5F11TLG and R5F11TLE)
		p.1	Addition of description in 1.1 Features
		p.3	Modification of note 2 in 1.1 Features
		p.4	Modification of Figure 1-1 Part Number, Memory Size, and Package of RL78/I1C
		p.4	Modification of Table 1-1 List of Ordering Part Numbers
		p.12	Deletion of note 1 in the “100-pin” column in 1.6 Outline of Functions
		p.13, 14	Modification of 1.6 Outline of Functions
		p.78	Modification of 2.7.3 VBAT pin voltage detection characteristics
		p.79	Modification of 2.7.4 VRTC pin voltage detection characteristics
		p.82	Deletion of note 2 for $V_{L1}$ in 2.8.2 Internal voltage boosting method, (1) 1/3 bias method
		p.83	Deletion of note 2 for $V_{L1}$ in 2.8.2 Internal voltage boosting method, (2) 1/4 bias method
2.11	Nov 30, 2022	Throughout	The module name for CSI was changed to simplified SPI. “Wait” was modified to “clock stretch”
		p.4	Modification of Figure 1-1. Part Number, Memory Size, and Package of RL78/I1C
		p.5	Modification of Table 1-1. List of Ordering Part Numbers
		p.88	Modification of package drawing in 3.1 64-pin Products (PLQP0064KB-C)
		p.89	Addition of package drawing in 3.1 64-pin Products (PLQP0064KL-A)
		p.90	Modification of package drawing in 3.2 80-pin Products (PLQP0080KB-B)
		p.91	Addition of package drawing in 3.2 80-pin Products (PLQP0080KJ-A)
		p.92	Modification of package drawing in 3.3 100-pin Products (PLQP0100KB-B)
		p.93	Addition of package drawing in 3.3 100-pin Products (PLQP0100KP-A)

The mark “<R>” shows major revised points. The revised points can be easily searched by copying an “<R>” in the PDF file and specifying it in the “Find what:” field.

All trademarks and registered trademarks are the property of their respective owners.

EEPROM is a trademark of Renesas Electronics Corporation.

SuperFlash is a registered trademark of Silicon Storage Technology, Inc. in several countries including the United States and Japan.

Caution: This product uses SuperFlash® technology licensed from Silicon Storage Technology, Inc.

## General Precautions in the Handling of Microprocessing Unit and Microcontroller Unit Products

The following usage notes are applicable to all Microprocessing unit and Microcontroller unit products from Renesas. For detailed usage notes on the products covered by this document, refer to the relevant sections of the document as well as any technical updates that have been issued for the products.

### 1. Precaution against Electrostatic Discharge (ESD)

A strong electrical field, when exposed to a CMOS device, can cause destruction of the gate oxide and ultimately degrade the device operation. Steps must be taken to stop the generation of static electricity as much as possible, and quickly dissipate it when it occurs. Environmental control must be adequate. When it is dry, a humidifier should be used. This is recommended to avoid using insulators that can easily build up static electricity. Semiconductor devices must be stored and transported in an anti-static container, static shielding bag or conductive material. All test and measurement tools including work benches and floors must be grounded. The operator must also be grounded using a wrist strap. Semiconductor devices must not be touched with bare hands. Similar precautions must be taken for printed circuit boards with mounted semiconductor devices.

### 2. Processing at power-on

The state of the product is undefined at the time when power is supplied. The states of internal circuits in the LSI are indeterminate and the states of register settings and pins are undefined at the time when power is supplied. In a finished product where the reset signal is applied to the external reset pin, the states of pins are not guaranteed from the time when power is supplied until the reset process is completed. In a similar way, the states of pins in a product that is reset by an on-chip power-on reset function are not guaranteed from the time when power is supplied until the power reaches the level at which resetting is specified.

### 3. Input of signal during power-off state

Do not input signals or an I/O pull-up power supply while the device is powered off. The current injection that results from input of such a signal or I/O pull-up power supply may cause malfunction and the abnormal current that passes in the device at this time may cause degradation of internal elements. Follow the guideline for input signal during power-off state as described in your product documentation.

### 4. Handling of unused pins

Handle unused pins in accordance with the directions given under handling of unused pins in the manual. The input pins of CMOS products are generally in the high-impedance state. In operation with an unused pin in the open-circuit state, extra electromagnetic noise is induced in the vicinity of the LSI, an associated shoot-through current flows internally, and malfunctions occur due to the false recognition of the pin state as an input signal become possible.

### 5. Clock signals

After applying a reset, only release the reset line after the operating clock signal becomes stable. When switching the clock signal during program execution, wait until the target clock signal is stabilized. When the clock signal is generated with an external resonator or from an external oscillator during a reset, ensure that the reset line is only released after full stabilization of the clock signal. Additionally, when switching to a clock signal produced with an external resonator or by an external oscillator while program execution is in progress, wait until the target clock signal is stable.

### 6. Voltage application waveform at input pin

Waveform distortion due to input noise or a reflected wave may cause malfunction. If the input of the CMOS device stays in the area between  $V_{IL}$  (Max.) and  $V_{IH}$  (Min.) due to noise, for example, the device may malfunction. Take care to prevent chattering noise from entering the device when the input level is fixed, and also in the transition period when the input level passes through the area between  $V_{IL}$  (Max.) and  $V_{IH}$  (Min.).

### 7. Prohibition of access to reserved addresses

Access to reserved addresses is prohibited. The reserved addresses are provided for possible future expansion of functions. Do not access these addresses as the correct operation of the LSI is not guaranteed.

### 8. Differences between products

Before changing from one product to another, for example to a product with a different part number, confirm that the change will not lead to problems. The characteristics of a microprocessing unit or microcontroller unit products in the same group but having a different part number might differ in terms of internal memory capacity, layout pattern, and other factors, which can affect the ranges of electrical characteristics, such as characteristic values, operating margins, immunity to noise, and amount of radiated noise. When changing to a product with a different part number, implement a system-evaluation test for the given product.