

N1913A and N1914A

EPM Series Power Meters, E-Series and 8480 Series Power Sensors

- Supports all average power sensors and their frequency range
- The power range depends on the connected power sensor
- Measurement speed: Up to 400 readings/sec with E-Series sensors
- Absolute accuracy: ± 0.02 dB logarithmic, $\pm 0.5\%$ linear
- Relative accuracy: ± 0.04 dB logarithmic, $\pm 1\%$ linear



Table of Contents

- Do More with New-Generation EPM Series Power Meters 3
- Using EPM Series with BenchVue Software..... 3
- Take a Closer Look 4
- N1913A/14A EPM Series Power Meter: Applications and Compatible Sensors for Average Power Measurements 5
- N1913A/14A EPM Series Power Meters Performance Characteristics..... 6
- N1913A/14A EPM Series Power Meters Ordering Information 12
- E-Series Power Sensor Specifications 14
- E-Series CW Power Sensor Specifications 14
- E-Series E9300 Average Power Sensor Specifications 17
- 848xD Series Diode and 8483A Thermocouple Power Sensor Specifications 24

Do More with New-Generation EPM Series Power Meters

- Get up to four channels¹ to speed and simplify RF average power measurements
- Measure faster with improved measurement speed of 400 readings/sec with the Keysight Technologies, Inc. E-Series sensors
- View test results more easily with the industry's first color LCD readout in an average power meter
- Go beyond GPIB with USB and LAN/LXI-C interfaces
- Automate frequency/power sweep measurements with the optional external trigger in/out feature
- Easily replace existing 436A, 437B and 438A meters with optional 43x code compatibility²
- Enhance manufacturing test by connecting a large external monitor with the unique VGA output option

As signals become more complex, it becomes more difficult to make fast, accurate power measurements. For years, you've depended on Keysight's EPM Series power meters. Today, the Keysight N1913A and N1914A EPM Series power meters are versatile, user-friendly replacements for the discontinued E4418B/19B EPM Series. Best of all, you get these extras for about the same price. Get consistent results and greater capability—with the new EPM Series power meters.

Using EPM Series with BenchVue Software

The EPM Series is supported by the Keysight BenchVue software's BV0007B Power Meter/Sensor Control and Analysis app. Keysight BenchVue software for the PC accelerates testing by providing intuitive, multiple instrument measurement visibility and data capture with no programming necessary. You can derive answers faster than ever by easily viewing, capturing and exporting measurement data and screen shots. BenchVue software license (BV0007B) is now included with your instrument.

For more information, www.keysight.com/find/BenchVue

¹ Additional two optional USB channels available (see Ordering Information).

² N1913A is backward compatible with the 436A and 437B, while N1914A is compatible with 438A.

Take a Closer Look

N1914A front panel

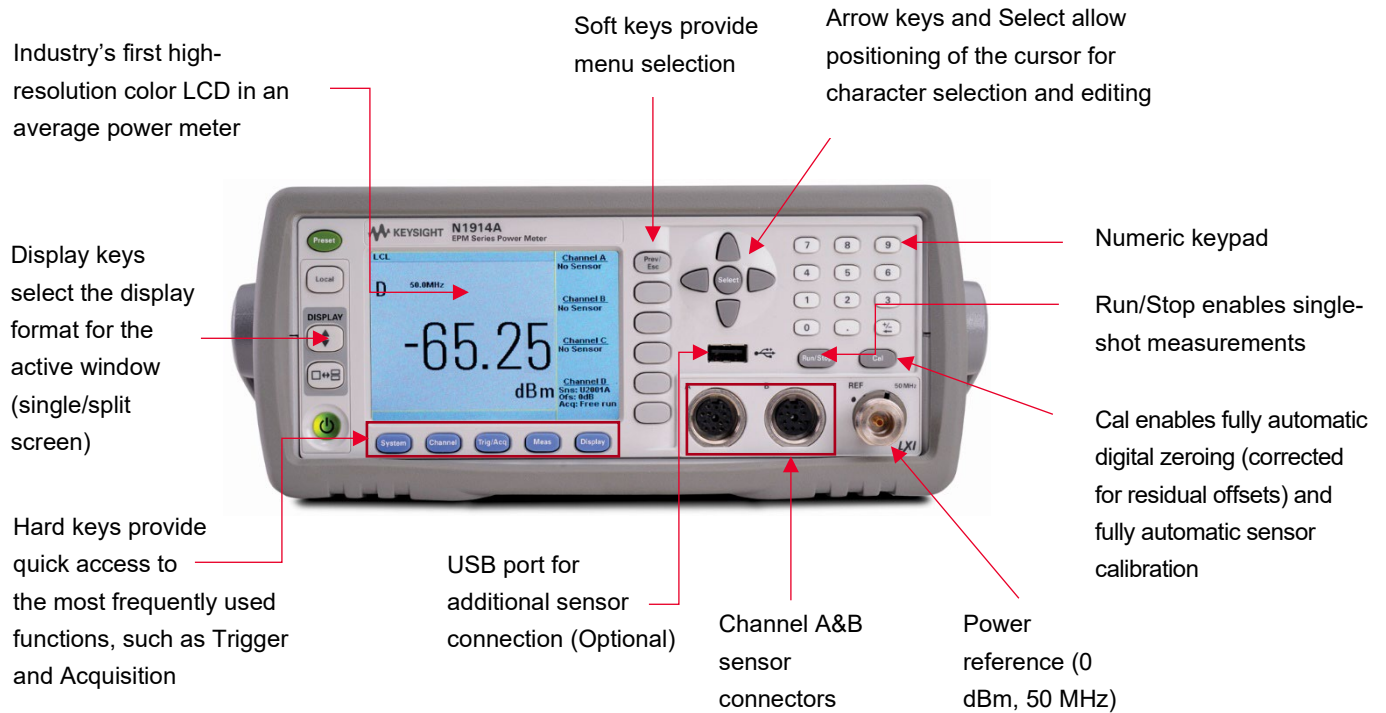

N1914A back panel

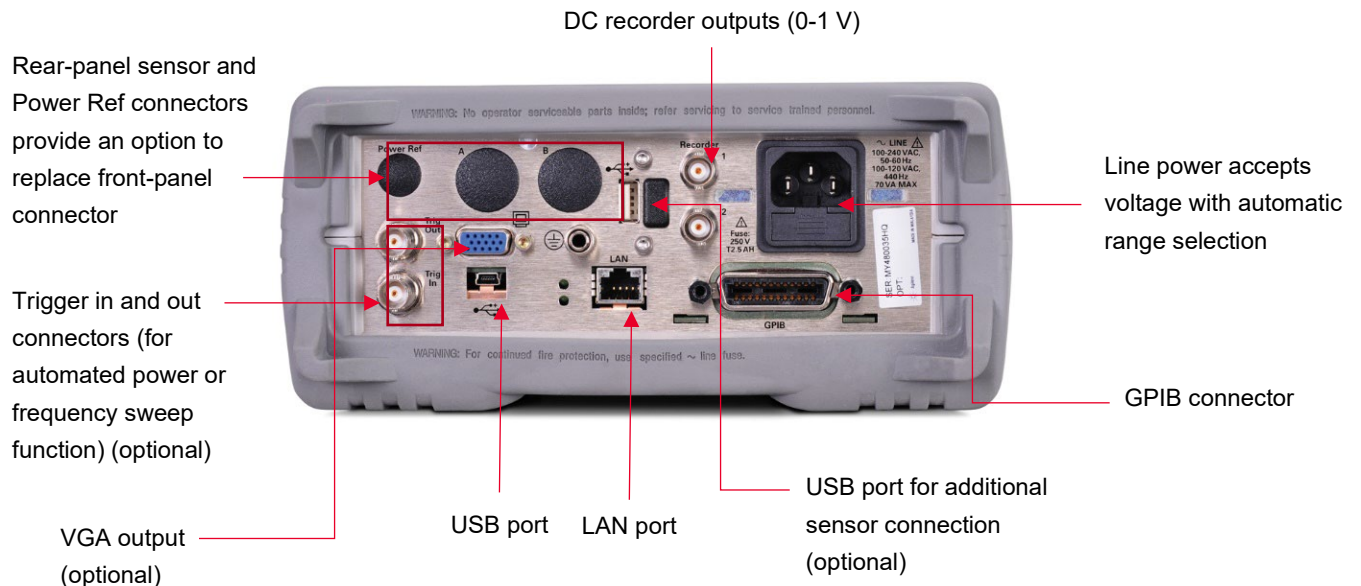

N1913A/14A EPM Series Power Meter: Applications and Compatible Sensors for Average Power Measurements

Table 1.

| Signal characteristics > | CW | | Modulated | | Wireless standards | | | |
|--|------------------|----------------------|-------------------|--|--|------------------------------|-------------------|--|
| | CW | Pulse/ averaged | AM/FM profiled | Mobile phone | WLAN | WPAN | WMAN | |
| Typical application examples > | Metrology lab | Radar/ navigation | Mobile radio | GSM, EDGE GPRS Cdma®2000 cdmaONE IDEN, 3G HSPA, LTE | 802.11a 802.11b 802.11g 802.11n | Bluetooth® RFID ZigBee | WiMax™ Wibro | |
| Thermocouple sensors: 8480A/B/H, N8480A/B/H, R/Q8486A, N8486AR/AQ ³ | • | • | • | • Average only | • Average only | • Average only | • Average only | |
| Diode sensors: 8480D, V8486A, W8486A ³ , E8486A | • | • | • | • Average only | • Average only | • Average only | • Average only | |
| Diode sensors compensated for extended range: E4412A/3A | • | | FM only | | | | | |
| Two-path diode-stack sensors: E9300 Series | • | • | • | • Average only | • Average only | • Average only | • Average only | |
| USB sensors: U2000A, U8480A & U2040/50/50 X-Series (except U2049XA, & U2042/44/60 X-Series in Average Mode only) | • | • | • | • Average only | • Average only | • Average only | • Average only | |

³ The N1913A/4A power meters are compatible with all 8480 Series power sensors, including discontinued models.

N1913A/14A EPM Series Power Meters

Performance Characteristics

Specifications describe the instrument's warranted performance and apply after a 30 minute warm-up. These specifications are valid over its operating/environmental range unless otherwise stated and after performing a zero and calibration procedure.

Supplemental characteristics (shown in italics) are intended to provide additional information, useful in applying the instrument by giving typical (expected), but not warranted performance parameters. These characteristics are shown in italics or labeled as "typical," "nominal" or "approximate."

Table 2. N1913A/14A EPM Series Power Meters Performance Characteristics

| Characteristic | |
|--------------------------------------|--|
| Compatible power sensors | Keysight 8480 Series |
| | Keysight E9300 E-Series |
| | Keysight E4410 E-Series |
| | Keysight N8480 Series |
| | Keysight E8486A, V8486A, W8486A |
| | Keysight U2000 Series |
| | Keysight U8480A Series |
| | Keysight U2040/50/60 X-Series (except U2049XA & U2042/44/60 X-Series in Average mode only) |
| Frequency range | 9 kHz to 110 GHz, sensor dependent |
| Power range | -70 to +44 dBm (100 pW to 25 W), sensor dependent |
| Single sensor dynamic range | 90 dB maximum (Keysight E-Series power sensors) |
| | 50 dB maximum (Keysight 8480 Series power sensors) |
| | 55 dB maximum (Keysight N8480 Series power sensors) |
| | 80 dB maximum (Keysight U2000 Series USB power sensors) |
| | 55 dB maximum (Keysight U8480A Series USB power sensors) |
| | 96 dB maximum (Keysight U2040/50/60 X-Series, except U2049XA & U2042/44/60 X-Series in Average mode only) |
| Display units | Absolute: Watts or dBm |
| | Relative: Percent or dB |
| Display resolution | Selectable resolution of 1.0, 0.1, 0.01 and 0.001 dB in logarithmic mode, or 1, 2, 3 and 4 significant digits in linear mode |
| Default resolution | dB in logarithmic mode or three digits in linear mode |
| Accuracy | |
| Absolute accuracy | ± 0.02 dB (Logarithmic) or $\pm 0.5\%$ (Linear). Please add the corresponding power sensor linearity percentage to assess the overall system accuracy. |
| Relative accuracy | ± 0.04 dB (Logarithmic) or $\pm 1.0\%$ (Linear). Please add the corresponding power sensor linearity percentage from the mentioned tables above to assess the overall system accuracy. |
| Zero set (digital stability of zero) | 0.0000175% (meter only) |
| | Power sensor dependent (refer Table 1), this specification applies when zeroing is performed with sensor input disconnected from the POWER REF. |
| Zero drift of sensors | This parameter is also called long term stability and is the change in the power meter indication over a long time (within one hour) at a constant temperature after a 24-hour warm-up of the power meter. Sensor dependent, refer to Table 3. For E9300 sensors, refer to Table 22 for complete data. |

Characteristic

Measurement noise

Sensor dependent, refer to Tables 1 and 2. For E9300 sensors, refer to Table 11 for complete data

| | |
|-------------------------------|--|
| Effects of averaging on noise | Averaging over 1 to 1024 readings is available for reducing noise. Table 1 provides the measurement noise for a particular power sensor with the number of averages set to 16 for normal mode and 32 for x2 mode. Use the "Noise Multiplier" for the appropriate mode (normal or x2) and number of averages to determine the total measurement noise value. For example: For a Keysight 8481D power sensor in normal mode with the number of averages set to 4, the measurement noise is equal to: ($< 45 \text{ pW} \times 2.75$) = $< 124 \text{ pW}$ |
|-------------------------------|--|

1 mW power reference

| | |
|--------------------------|---|
| Power output | 1.00 mW (0.0 dBm). Factory set to $\pm 0.4 \%$ traceable to the National Physical Laboratories (NPL), UK |
| Accuracy (for two years) | $\pm 0.4\%$ ($25 \pm 10 \text{ }^\circ\text{C}$) $\pm 1.2\%$ ($0 \text{ to } 55 \text{ }^\circ\text{C}$) |
| Frequency | 50 MHz nominal |
| SWR | 1.05 (typical), 1.08 ($0 \text{ to } 55 \text{ }^\circ\text{C}$) |
| Connector type | Type-N (f), 50 Ω |

Measurement speed

Using remote interface (over the GPIB, USB or LAN), three measurement speed modes are available as shown, along with the typical maximum measurement speed for each mode.

| | |
|-------------------------|---|
| With N1913A power meter | Normal: 20 readings/second |
| | x2: 40 readings/second |
| | Fast: 400 readings/second, for Keysight E- Series power sensors only |
| With N1914A power meter | The measurement speed is reduced, for example, with both channels in FAST mode, the typical maximum measurement speed is 200 readings/second. |

Fast mode is for Keysight E-Series power sensors only.

Maximum measurement speed is obtained using binary output in free run trigger mode.

Table 3. Power sensors zero set, zero drift and measurement noise

| Model | Zero set | Zero drift ⁴ | Measurement noise ⁵ |
|--|-------------------------------|---------------------------------|--------------------------------|
| E9300A, E9301A, E9304A ⁶ | $\pm 500 \text{ pW}$ | $< \pm 150 \text{ pW}$ | $< 700 \text{ pW}$ |
| E9300B, E9301B ⁶ | $\pm 500 \text{ nW}$ | $< \pm 150 \text{ nW}$ | $< 700 \text{ nW}$ |
| E9300H, E9301H ⁶ | $\pm 5 \text{ nW}$ | $< \pm 1.5 \text{ nW}$ | $< 7 \text{ nW}$ |
| E4412A, E4413A | $\pm 50 \text{ pW}$ | $< \pm 15 \text{ pW}$ | $< 70 \text{ pW}$ |
| N8481A, N8482A, N8485A, N8487A, N8486AR, N8486AQ | $\pm 25 \text{ nW}$ | $< \pm 3 \text{ nW}$ | $< 80 \text{ nW}$ |
| 8483A | $\pm 50 \text{ nW}$ | $< \pm 10 \text{ nW}$ | $< 110 \text{ nW}$ |
| N8481B, N8482B | $\pm 50 \text{ } \mu\text{W}$ | $< \pm 10 \text{ } \mu\text{W}$ | $< 110 \text{ } \mu\text{W}$ |
| 8481D, 8485D, 8487D | $\pm 20 \text{ pW}$ | $< \pm 4 \text{ pW}$ | $< 45 \text{ pW}$ |
| N8481H, N8482H | $\pm 5 \text{ } \mu\text{W}$ | $< \pm 1 \text{ } \mu\text{W}$ | $< 10 \text{ } \mu\text{W}$ |
| R8486D, Q8486D | $\pm 30 \text{ pW}$ | $< \pm 6 \text{ pW}$ | $< 65 \text{ pW}$ |
| V8486A, W8486A | $\pm 200 \text{ nW}$ | $< \pm 40 \text{ nW}$ | $< 450 \text{ nW}$ |

⁴ Within 1 hour after zero set, at a constant temperature, after a 24-hour warm-up of the power meter.

⁵ The number of averages at 16 for normal mode and 32 for x2 mode, at a constant temperature, measured over a one minute interval and two standard deviations. For E-Series sensors, the measurement noise is measured within the low range. Refer to the relevant sensor manual for further information.

⁶ Specification applies to the low power path, 15 to 75% relative humidity.

The 8480 Series sensors in the table do not include discontinued models.

Table 4. Noise multiplier

| Number of averages | 1 | 2 | 4 | 8 | 16 | 32 | 64 | 128 | 256 | 512 | 1024 |
|-------------------------|-----|------|------|------|------|------|------|------|------|------|------|
| Noise multiplier | | | | | | | | | | | |
| Normal mode | 5.5 | 3.89 | 2.75 | 1.94 | 1 | 0.85 | 0.61 | 0.49 | 0.34 | 0.24 | 0.17 |
| x2 mode | 6.5 | 4.6 | 3.25 | 2.3 | 1.63 | 1 | 0.72 | 0.57 | 0.41 | 0.29 | 0.2 |

Settling time ⁷

Manual filter, 10-dB decreasing power step for normal and x2 modes (not across range switch points for E-Series and N8480 Series sensors).

Table 5. Settling time

| Number of averages | 1 | 2 | 4 | 8 | 16 | 32 | 64 | 128 | 256 | 512 | 1024 |
|--|------|------|------|------|------|-----|-----|-----|-----|------|------|
| Settling time with E-Series sensors(s) | | | | | | | | | | | |
| Normal mode | 0.08 | 0.13 | 0.24 | 0.45 | 1.1 | 1.9 | 3.5 | 6.7 | 14 | 27 | 57 |
| x2 mode | 0.07 | 0.09 | 0.15 | 0.24 | 0.45 | 1.1 | 1.9 | 3.6 | 6.7 | 14 | 27 |
| Settling time with N8480 Series sensors (s) | | | | | | | | | | | |
| Normal mode | 0.15 | 0.2 | 0.3 | 0.5 | 1.1 | 1.9 | 3.4 | 6.6 | 13 | 27 | 57 |
| x2 mode | 0.15 | 0.18 | 0.22 | 0.35 | 0.55 | 1.1 | 1.9 | 3.5 | 6.9 | 14.5 | 33 |
| Settling time with 8480 Series sensors (s) | | | | | | | | | | | |
| Normal mode | 0.15 | 0.2 | 0.3 | 0.5 | 1.1 | 1.9 | 3.4 | 6.6 | 13 | 27 | 57 |
| x2 mode | 0.15 | 0.18 | 0.22 | 0.35 | 0.55 | 1.1 | 1.9 | 3.5 | 6.9 | 14.5 | 33 |

E-Series sensors In FAST mode (using free run trigger), within the range –50 dBm to +17 dBm, for a 10 dB decreasing power step, the settling time is:

- N1913A: 10 ms ⁸
- N1914A: 20 ms ⁸

⁷ Settling time: 0 to 99% settled readings over the GPIB.

⁸ When a power step crosses through the sensor's auto-range switch point, add 25 ms. Refer to the relevant sensor manual for switch point information.

Settling time (Continued)

Auto filter, 10 dB decreasing power step for normal and X2 modes (not across the range switch points for E-Series and N8480 Series sensors).

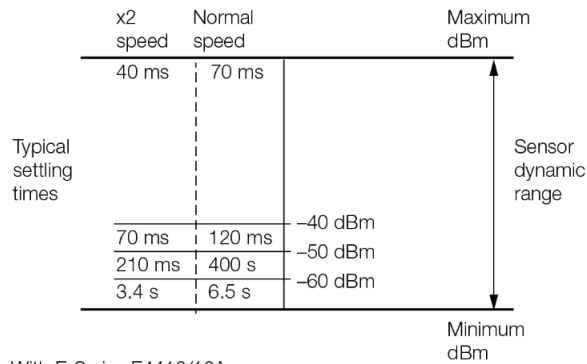

With E-Series E4412/13A sensors

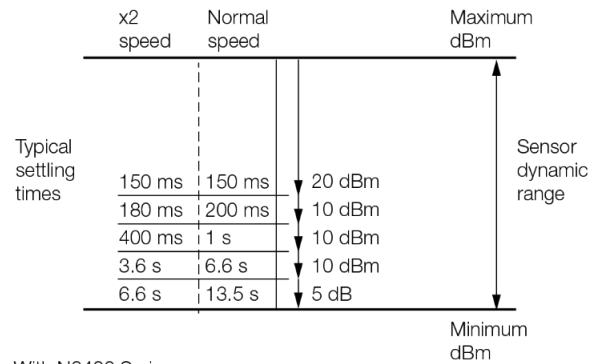

With N8480 Series sensors

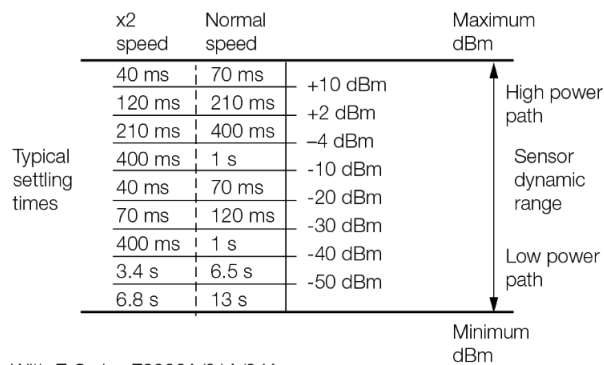

With E-Series E9300A/01A/04A sensors

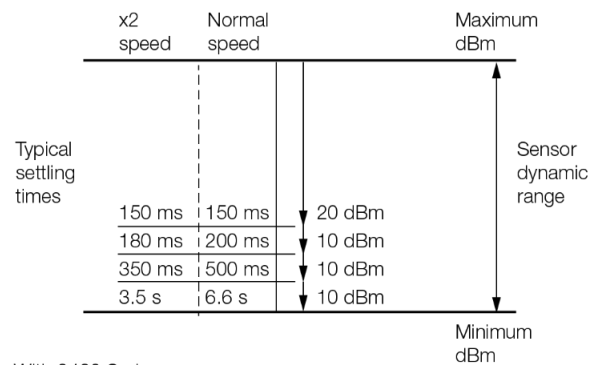

With 8480 Series sensors

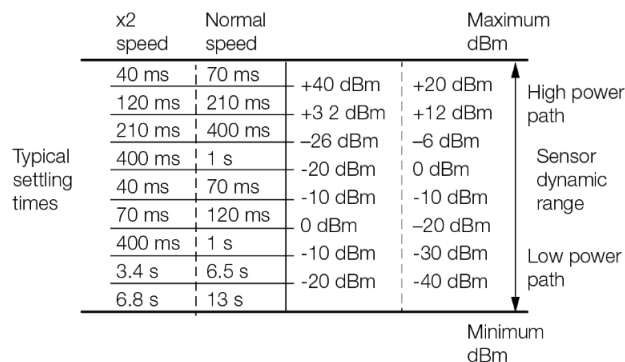

With E-Series E9300B/01B/00H/01H sensor

Table 6.

| Power meter functions | |
|------------------------------------|--|
| Accessed by key entry | Either hard keys, or soft key menu, and programmable |
| Zero | Zeros the meter. (Power reference calibrator is switched off during zeroing.) |
| Cal | Calibrates the meter using internal (power reference calibrator) or external source. Reference cal factor settable from 1% to 150%, in 0.1% increments. |
| Frequency | Entered frequency range is used to interpolate the calibration factors table. Frequency range from 1 kHz to 999.9 GHz. Also settable in 1 kHz steps. |
| Cal factor | Sets the calibration factor for the meter. Range: 1% to 150%, in 0.1% increments. |
| Relative | Displays all successive measurements relative to the last displayed value |
| Offset | Allows power measurements to be offset by -100 dB to +100 dB, settable in 0.001 dB increments, to compensate for external loss or gain |
| Save/recall | Store up to 10 instrument states via the save/recall menu |
| dBm/W | Selectable units of either Watts or dBm in absolute power; or percent or dB for relative measurements |
| Filter (averaging) | Selectable from 1 to 1024. Auto-averaging provides automatic noise compensation. |
| Duty cycle | Duty cycle values between 0.001% to 99.999%, in 0.001% increments, can be entered to display a peak power representation of measured power. The following equation is used to calculate the displayed peak power value: peak power = measured power/duty cycle. |
| Sensor cal tables | Selects cal factor versus frequency tables corresponding to specified sensors |
| Limits | High and low limits can be set in the range -150.000 to +230.000 dBm, in 0.001 dBm increments |
| Preset default values | dBm mode, rel off, power reference off, duty cycle off, offset off, frequency 50 MHz, AUTO average, free run, AUTO range (for E-Series sensors and N8480 Series) |
| Display | Color display with selectable single and split screen formats are available. A quasi-analog display is available for peaking measurements. The dual channel power meter can simultaneously display any two configurations of A, B, A/B, B/A, A-B, B-A and relative. With the optional USB ports, additional dual channel (C & D), adds up to total 4-channels measurement display. |
| Power meter general specifications | |
| Dimensions | The following dimensions exclude front and rear protrusions: 212.6 mm W x 88.5 mm H x 348.3 mm D (8.5 in x 3.5 in x 13.7 in) |
| Weight | Model Net Shipping |
| | N1913A 3.6 kg (8.0 lb) 8.2 kg (18.1 lb) |
| | N1914A 3.7 kg (8.2 lb) 8.2 kg (18.3 lb) |

Table 7. N1913A/14A EPM Series Power Meters Performance Characteristics

| Rear panel connectors | |
|--|---|
| Recorder outputs | Analog 0 to 1 volt, 1 k Ω output impedance, BNC connector. N1914A recorder outputs are dedicated to channel A and channel B. |
| GPIO, USB 2.0 and 10/100BaseT LAN | Interfaces to allow communication with an external controller |
| Trigger Input (optional) ⁹ | Input has TTL compatible logic levels and uses a BNC connector: High: > 2.4 V Low: < 0.7 V |
| Trigger Output (optional) ⁹ | Output provides TTL compatible logic levels and uses a BNC connector: High: > 2.4 V Low: < 0.7 V |
| Ground | Binding post, accepts 4 mm plug or bare wire connection |
| USB Host (options) | USB ports which connect to USB power sensors |
| VGA Out (options) | Standard 15-pin VGA connector, allows connection of external VGA monitor |
| Line power | |
| Input voltage range | 90 to 264 VAC, automatic selection |
| Input frequency range | 47 to 63 Hz and 400 Hz at 110 Vac |
| Power requirement | 75 VA (50 Watts) |
| Environmental characteristics | |
| Electromagnetic compatibility | Complies with the essential requirements of EMC Directive (2004/108/EC) as follows: IEC61326- 1:2005 / EN61326- 1:2006 CISPR11:2003 / EN55011:2007 (Group 1, Class A) The product also meets the following EMC standards: Canada: ICES/NMB- 001:2004 Australia/New Zealand: AS/NZS CISPR 11:2004 |
| Product safety | This product conforms to the requirements of the following safety standards: IEC/EN 61010- 1 CAN/CSA- C22.2 No.61010- 1- 04 ANSI/UL61010- 1:2004 |
| Low Voltage Directive | This product conforms to the requirements of European Council Directive "2006/95/EC" |
| Operating environment | |
| Temperature | 0 to 55 °C |
| Maximum humidity | 95% at 40 °C (non-condensing) |
| Maximum altitude | 4,600 meters (15,000 feet) |
| Storage conditions | |
| Non-operating storage temperature | -40 to +70 °C |
| Non-operating maximum humidity | 90% at 65 °C (non-condensing) |
| Non-operating maximum altitude | 4,600 meters (15,000 feet) |
| Remote programming | |
| Interface | GPIO, USB and LAN interfaces operates to IEEE 488.2 standard |
| Command language | SCPI standard interface commands. Code-compatible with legacy E4418B/9B EPM Series, 436A, 437B and 438A power meters (43X compatibility only with option N191xA-200). |
| GPIO compatibility | SH1, AH1, T6, TE0, L4, LE0, SR1, RL1, PP1, DC1, DT1, C0 |

Note: Characteristics describe product performance that is useful in the application of the product but is not covered by the product warranty.

⁹ For automated power or frequency sweep function.

N1913A/14A EPM Series Power Meters Ordering Information

Table 8. Power meters

| Model | Description |
|--------|------------------------------------|
| N1913A | Single-channel average power meter |
| N1914A | Dual-channel average power meter |

Standard-shipped accessories

- Power cord
- Power sensor cable, 1.5 m (5 ft) (One per N1913A, two per N1914A)
- USB cable Type A to Mini-B, 6 ft

Table 9. Options

| Power meter configurations | |
|----------------------------|---|
| N1913/4A-004 | Delete power sensor cable(s) |
| N1913/4A-101 ¹⁰ | Single/dual-channel average power meter |
| N1913/4A-201 | Single/dual-channel average power meter with VGA, trigger in/out, 1 front and 1 rear USB port |
| N1913/4A-B01 | Without battery (mandatory for Option 201) |
| N1913/4A-C01 | Front calibrator, front sensor |
| N1913/4A-C02 | Front calibrator, parallel front and rear sensor |
| N1913/4A-C03 | Rear calibrator, parallel front and rear sensor |
| N1913A-200 | 436A and 437B code compatibility for new N1913A purchase |
| N1914A-200 | 438A code compatibility for new N1914A purchase |
| N6901A-1FP | 436A and 437B code compatibility for N1913A. Post purchase upgrade only. |
| N6902A-1FP | 438A code compatibility for N1914A. Post purchase upgrade only. |
| Power sensor cables | |
| 11730A | Power sensor cable: 1.5 m/5 ft |
| 11730B | Power sensor cable: 3.0 m/10 ft |
| 11730C | Power sensor cable: 6.1 m/20 ft |
| 11730D | Power sensor cable: 15.2 m/50 ft |
| 11730E | Power sensor cable: 30.5 m/100 ft |
| 11730F | Power sensor cable: 61 m/200 ft |

¹⁰ Option 101 provides the calibrator and the sensor(s) on the front panel. It can't be ordered with any of the B0x/C0x options.

| Other accessories | |
|-----------------------------------|---|
| 34131A | Transit case |
| 34141A | Soft carrying case |
| 34161A | Accessory pouch |
| N191xA-908 | Rackmount kit for one instrument |
| N191xA-909 | Rackmount kit for two instruments |
| Software | |
| BV0007B | BenchVue Power Meter/Sensor Control and Analysis app license |
| Calibration | |
| N191xA-1A7 | Calibration + Uncertainties + Guardbanding |
| N191xA-A6J | ANSI Z540-1-1994 Calibration |
| R-50C-011-3 | Calibration Assurance Plan - Return to Keysight - 3 years |
| R-50C-011-5 | Calibration Assurance Plan - Return to Keysight - 5 years |
| R-50C-021-3 | ANSI Z540-1-1994 Calibration - 3 years |
| R-50C-021-5 | ANSI Z540-1-1994 Calibration - 5 years |
| GPIB connectivity products | |
| 82357B | USB/GPIB converter |
| 10833x | GPIB cables: 10833D (0.5 m), 10833A (1 m), 10833B (2 m), 10833C (4 m), 10833F (6 m), 10833G (8 m) |

E-Series Power Sensor Specifications

The E-Series of power sensors have their calibration factors stored in EEPROM and operate over a wide dynamic range. They are designed for use with the EPM Series of power meters and two classes of sensors are available:

- CW power sensors (E4412A and E4413A)
- Average power sensors (E9300 sensors)

E-Series CW Power Sensor Specifications

Widest dynamic range: 100 pW to 100 mW (–70 to +20 dBm)

Table 11. E4410 Series max SWR specification

| Model | Maximum SWR | Maximum SWR | Maximum power | Connector type |
|--------|--------------------|------------------------------------|------------------|----------------|
| E4412A | 10 MHz to 18 GHz | 10 to < 30 MHz: 1.22 ¹¹ | 200 mW (+23 dBm) | Type-N (m) |
| | | 30 MHz to < 2 GHz: 1.15 | | |
| | | 2 to < 6 GHz: 1.17 ¹² | | |
| | | 6 to < 11 GHz: 1.2 | | |
| | | 11 to 18 GHz: 1.27 ¹³ | | |
| E4413A | 50 MHz to 26.5 GHz | 50 to < 100 MHz: 1.21 | 200 mW (+23 dBm) | APC-3.5 mm (m) |
| | | 100 MHz to < 8 GHz: 1.19 | | |
| | | 8 to < 18 GHz: 1.21 ¹⁴ | | |
| | | 18 to 26.5 GHz: 1.26 ¹⁵ | | |

Calibration factor (CF) and reflection coefficient (Rho)

Calibration factor and reflection coefficient data are provided at 1 GHz increments on a data sheet included with the power sensor. This data is unique to each sensor. If you have more than one sensor, match the serial number on the data sheet with the serial number on the power sensor you are using. The CF corrects for the frequency response of the sensor. The EPM power meter automatically reads the CF data stored in the sensor and uses it to make the corrections.

Reflection coefficient (Rho) relates to the SWR according to the following formula:

$$SWR = 1 + Rho / 1 - Rho$$

Maximum uncertainties of the CF data are listed in Table 5a, for the E4412A power sensor, and Table 5b for the E4413A power sensor. The uncertainty analysis for the calibration of the sensors was done in accordance with the ISO/TAG4 Guide. The uncertainty data reported on the calibration certificate is the expanded uncertainty with a 95% confidence level and a coverage factor of 2.

¹¹ Applies to sensors with serial prefix US 3848 or greater.

¹² Max SWR is 1.2 for high power from +17 to +20 dBm.

¹³ Max SWR is 1.34 for high power from +17 to +20 dBm.

¹⁴ Max SWR is 1.28 for high power from +17 to +20 dBm.

¹⁵ Max SWR is 1.49 for high power from +17 to +20 dBm.

Table 12. E4412A calibration factor uncertainty at calibrated powers

| Frequency | Uncertainty ¹⁶ (%) |
|-------------------|-------------------------------|
| 50 MHz | Reference |
| 10 to < 30 MHz | 1.8 |
| 30 MHz to < 2 GHz | 1.8 |
| 2 to < 16 GHz | 2.4 |
| 16 to 18 GHz | 2.6 |

Table 13. E4413A calibration factor uncertainty at calibrated powers

| Frequency | Uncertainty ¹⁶ (%) |
|--------------------|-------------------------------|
| 50 MHz | Reference |
| 100 MHz to < 2 GHz | 1.8 |
| 2 to < 10 GHz | 2.4 |
| 10 to < 12 GHz | 2.6 |
| 12 to < 20 GHz | 2.8 |
| 20 to 26.5 GHz | 3.0 |

¹⁶ For power levels greater than 0 dBm, add 0.5%/dB to the calibration factor uncertainty specification

Power linearity

Table 14. E4410 Series power linearity specification

| Power | Temperature (25 ± 5 °C) | Temperature (0 to 55 °C) |
|----------------------------------|-------------------------|--------------------------|
| 100 pW to 10 mW (-70 to +10 dBm) | ± 3% | ± 7% |
| 10 mW to 100 mW (+10 to +20 dBm) | ± 4.5% | ± 10% |

The chart in Figure 1 shows the typical uncertainty in making a relative power measurement, using the same power meter channel and the same power sensor to obtain the reference and the measured values. Example A illustrates a relative gain (amplifier measurement). Example B illustrates a relative loss (insertion loss measurement). This chart assumes negligible change in frequency and mismatch occur when transitioning from the power level used as the reference to the power level being measured.

Example A

- $P = 10(P)/10 \times 1 \text{ mW}$
- $P = 10^{-6}/10 \times 1 \text{ mW}$
- $P = 3.98 \text{ mW}$
- $3\% \times 3.98 \text{ mW} = 119.4 \text{ } \mu\text{W}$

Example B

- $P = 10^{-35}/10 \times 1 \text{ mW}$
- $P = 10^{-35}/10 \times 1 \text{ mW}$
- $P = 316 \text{ nW}$
- $3\% \times 316 \text{ nW} = 9.48 \text{ nW}$

where

- P = power in Watts

and

- (P) = power in dBm

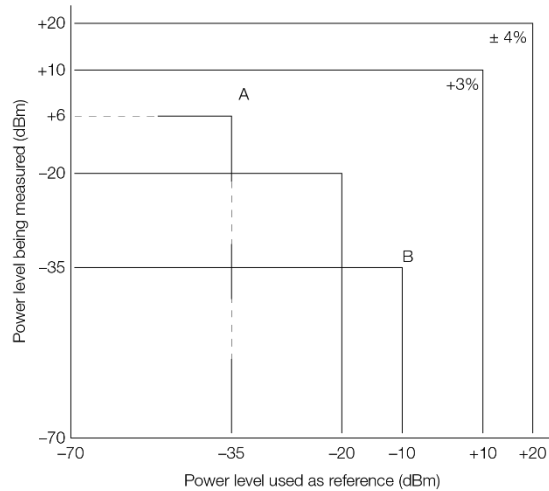

Figure 1. Relative mode power measurement linearity with EPM Series power meter/E-Series CW power sensor at 25 °C ± 5 °C (typical).



Mechanical characteristics such as center conductor protrusion and pin depth are not performance specifications. They are, however, important supplemental characteristics related to electrical performance. At no time should the pin depth of the connector be protruding.

E-Series E9300 Average Power Sensor Specifications

The E-Series E9300 wide dynamic range, average power sensors are designed for use with the EPM family of power meters. These specifications are valid ONLY after proper calibration of the power meter and apply for CW signals unless otherwise stated.

Specifications apply over the temperature range 0 to 55 °C unless otherwise stated, and specifications quoted over the temperature range 25 °C ± 10 °C, conform to the standard environmental test conditions as defined in TIA/EIA/IS-97-A and TIA/EIA/IS-98-A.

The E-Series E9300 power sensors have two independent measurement paths (high and low power paths) as shown in Table 15.

Table 15. E9300 Series two-path specification

| | “A” suffix sensors | “B” suffix sensors | “H” suffix sensors |
|-----------------|--------------------|--------------------|--------------------|
| High power path | -10 to +20 dBm | +20 to +44 dBm | 0 to +30 dBm |
| Low power path | -60 to -10 dBm | -30 to +20 dBm | -50 to 0 dBm |

Table 16. E9300 Series sensors specification

| Model | Frequency range | Maximum SWR (25 °C ± 10 °C) | Maximum SWR (0 to 55 °C) | Maximum power | Connector type |
|--|------------------|-----------------------------|--------------------------|---|----------------|
| -60 to +20 dBm wide dynamic range sensors | | | | | |
| E9300A | 10 MHz to 18 GHz | 10 to < 30 MHz: 1.15 | 10 to < 30 MHz: 1.21 | +25 dBm (320 mW) average | Type-N (m) |
| | | 30 MHz to < 2 GHz: 1.13 | 30 MHz to < 2 GHz: 1.15 | +33 dBm peak (2 W) (< 10 µsec) | |
| | | 2 to < 14 GHz: 1.19 | 2 to < 14 GHz: 1.20 | | |
| | | 14 to < 16 GHz: 1.22 | 14 to < 16 GHz: 1.23 | | |
| E9301A | 10 MHz to 6 GHz | 10 to < 30 MHz: 1.15 | 10 to < 30 MHz: 1.21 | +25 dBm (320 mW) average | Type-N (m) |
| | | 30 MHz to < 2 GHz: 1.13 | 30 MHz to < 2 GHz: 1.15 | +33 dBm peak (2 W) (< 10 µsec) | |
| | | 2 to 6 GHz: 1.19 | 2 to 6 GHz: 1.20 | | |
| E9304A | 9 kHz to 6 GHz | 9 KHz to < 2 GHz: 1.13 | 9 KHz to < 2 GHz: 1.15 | +25 dBm (320 mW) average | Type-N (m) |
| | | 2 to 6 GHz: 1.19 | 2 to 6 GHz: 1.20 | +33 dBm peak (2 W) (< 10 µsec) | |
| -30 to +44 dBm wide dynamic range sensors | | | | | |
| E9300B | 10 MHz to 18 GHz | 10 MHz to < 8 GHz: 1.12 | 10 MHz to < 8 GHz: 1.14 | 0 to 35 °C: 30 W avg | Type-N (m) |
| | | 8 to < 12.4 GHz: 1.17 | 8 to < 12.4 GHz: 1.18 | 35 to 55 °C: 25 W avg | |
| | | 12.4 to 18 GHz: 1.24 | 12.4 to 18 GHz: 1.25 | < 6 GHz: 500 W pk > 6 GHz: 125 W pk 500 W. µS per pulse | |
| E9301B | 10 MHz to 6 GHz | 10 MHz to 6 GHz: 1.12 | 10 MHz to 6 GHz: 1.14 | 0 to 35 °C: 30 W avg | Type-N (m) |
| | | | | 35 to 55 °C: 25 W avg | |
| | | | | < 6 GHz: 500 W pk | |
| | | | | > 6 GHz: 125 W pk 500 W. µS per pulse | |

| Model | Frequency range | Maximum SWR (25 °C ± 10 °C) | Maximum SWR (0 to 55 °C) | Maximum power | Connector type |
|--|------------------|-----------------------------|--------------------------|---------------------|----------------|
| -50 to +30 dBm wide dynamic range sensors | | | | | |
| E9300H | 10 MHz to 18 GHz | 10 MHz to < 8 GHz: 1.15 | 10 MHz to < 8 GHz: 1.17 | 3.16 W avg | Type-N (m) |
| | | 8 to < 12.4 GHz: 1.25 | 8 to < 12.4 GHz: 1.26 | 100 W pk | |
| | | 12.4 to 18GHz: 1.28 | 12.4 to 18GHz: 1.29 | 100 W, μS per pulse | |
| E9301H | 10 MHz to 6 GHz | 10 MHz to < 6 GHz: 1.15 | 10 MHz to < 6 GHz: 1.17 | 3.16 W avg | Type-N (m) |
| | | | | 100 W pk | |
| | | | | 100 W, μS per pulse | |

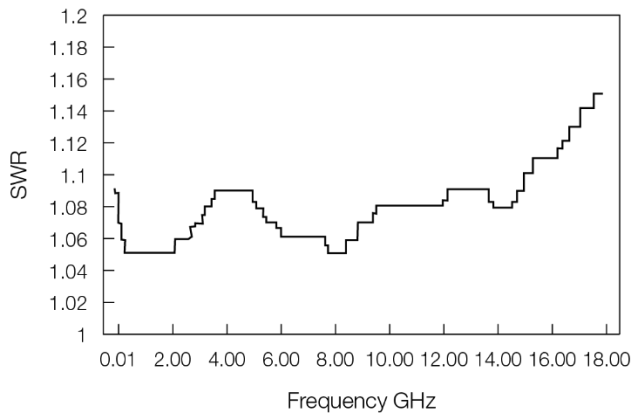

Typical SWR, 10 MHz to 18 GHz (25 °C ± 10 °C) for E9300A and E9301A sensor.

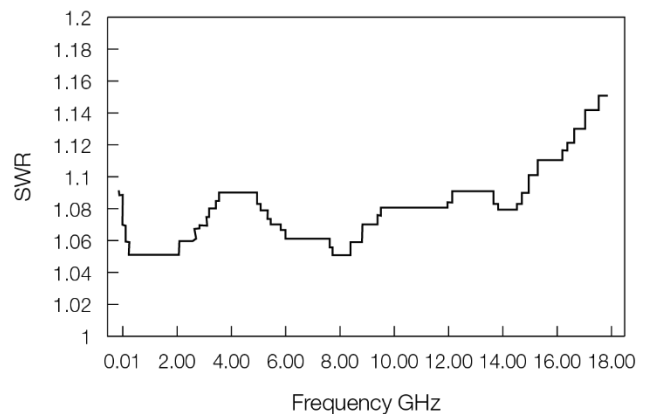

Typical SWR, 9 kHz to 6 GHz (25 °C ± 10 °C) for E9304A sensors.

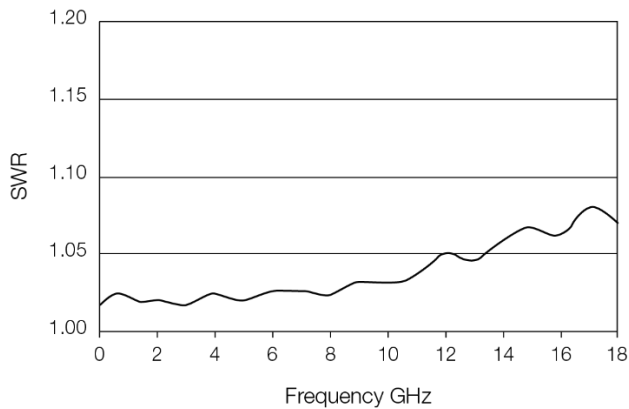

Typical SWR, 10 MHz to 18 GHz (25 °C ± 10 °C) for E9300B and E9301B sensors.

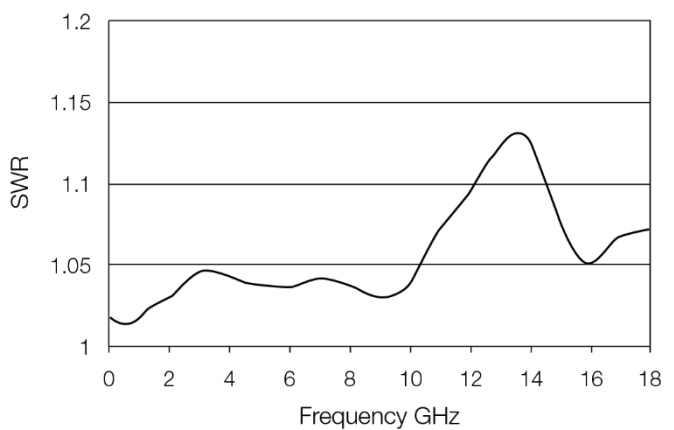

Typical SWR, 10 MHz to 18 GHz (25 °C ± 10 °C) for E9300H and E9301H sensors.

Power linearity ¹⁷

Table 17. E9300 Series power linearity (after zero and cal at ambient environmental conditions) sensor

| Sensor | Power | Linearity (25 ± 10 °C) | Linearity (0 to 55 °C) |
|------------------------|----------------|------------------------|------------------------|
| E9300A, E9301A, E9304A | -60 to -10 dBm | ± 3.0% | ± 3.5% |
| | -10 to 0 dBm | ± 2.5% | ± 3.0% |
| | 0 to +20 dBm | ± 2.0% | ± 2.5% |
| E9300B, E9301B | -30 to +20 dBm | ± 3.5% | ± 4.0% |
| | +20 to +30 dBm | ± 3.0% | ± 3.5% |
| | +30 to +44 dBm | ± 2.5% | ± 3.0% |
| E9300H, E9301H | -50 to 0 dBm | ± 4.0% | ± 5.0% |
| | 0 to +10 dBm | ± 3.5% | ± 4.0% |
| | +10 to +30 dBm | ± 3.0% | ± 3.5% |

Typical E9300A/01A/04A power linearity at 25 °C, after zero and calibration, with associated measurement uncertainty.

Table 18.

| Power range | Measurement uncertainty |
|----------------|-------------------------|
| -30 to -20 dBm | ± 0.9% |
| -20 to -10 dBm | ± 0.8% |
| -10 to 0 dBm | ± 0.65% |
| 0 to +10 dBm | ± 0.55% |
| +10 to +20 dBm | ± 0.45% |

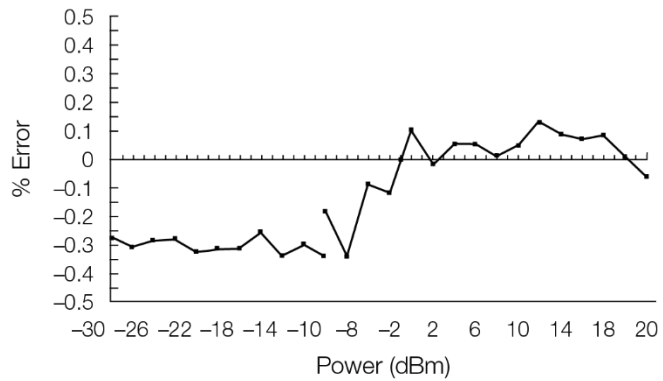

Typical E9300B/01B power linearity at 25 °C, after zero and calibration, with associated measurement uncertainty.

Table 19.

| Power range | Measurement uncertainty |
|----------------|-------------------------|
| -6 to 0 dBm | ± 0.65% |
| 0 to +10 dBm | ± 0.55% |
| +10 to +20 dBm | ± 0.45% |
| +20 to +26 dBm | ± 0.31% |

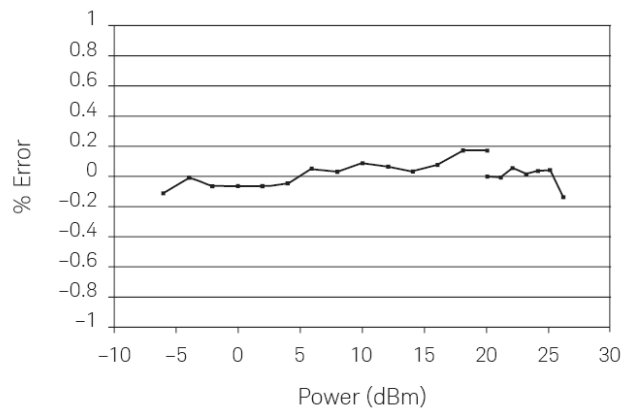

¹⁷ After zero and calibration at ambient environmental conditions.

Typical E9300H/01H power linearity at 25 °C, after zero and calibration, with associated measurement uncertainty.

Table 20.

| Power range | Measurement uncertainty |
|----------------|-------------------------|
| -26 to -20 dBm | ± 0.9% |
| -20 to -10 dBm | ± 0.8% |
| -10 to 0 dBm | ± 0.65% |
| 0 to +10 dBm | ± 0.55% |
| +10 to +20 dBm | ± 0.45% |
| +20 to +26 dBm | ± 0.31% |

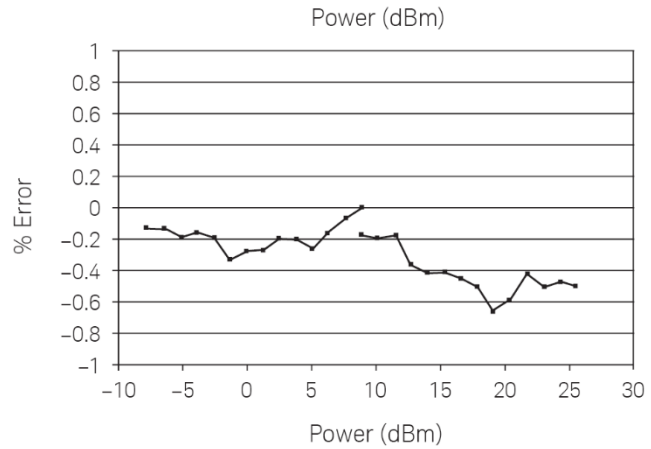

Effects of change in temperature on linearity

Note: If the temperature changes after calibration and you choose not to re-calibrate the sensor, the following additional power linearity error should be added to the linearity specs.

For small changes in temperature: The typical maximum additional power linearity error due to small temperature change after calibration is ± 0.15%/°C (valid after zeroing the sensor).

Table 21. Typical maximum additional power linearity error due to temperature change (valid after zeroing the sensor)

| Sensor | Power | Additional power linearity error (25 °C ± 10 °C) | Additional power linearity error (0 to 55 °C) |
|------------------------|----------------|--|---|
| E9300A, E9301A, E9304A | -60 to -10 dBm | ± 1.5% | ± 2.0% |
| | -10 to 0 dBm | ± 1.5% | ± 2.5% |
| | 0 to +20 dBm | ± 1.5% | ± 2.0% |
| E9300B, E9301B | -30 to +20 dBm | ± 1.5% | ± 2.0% |
| | +20 to +30 dBm | ± 1.5% | ± 2.5% |
| | +30 to +44 dBm | ± 1.5% | ± 2.0% |
| E9300H, E9301H | -50 to 0 dBm | ± 1.5% | ± 2.0% |
| | 0 to +10 dBm | ± 1.5% | ± 2.5% |
| | +10 to +30 dBm | ± 1.5% | ± 2.0% |

Figure 2 shows the typical uncertainty in making a relative power measurement, using the same power meter channel and same power sensor to obtain the reference and the measured values, and assumes that negligible change in frequency and mismatch error occur when transitioning from the power level used as the reference to the power level being measured.

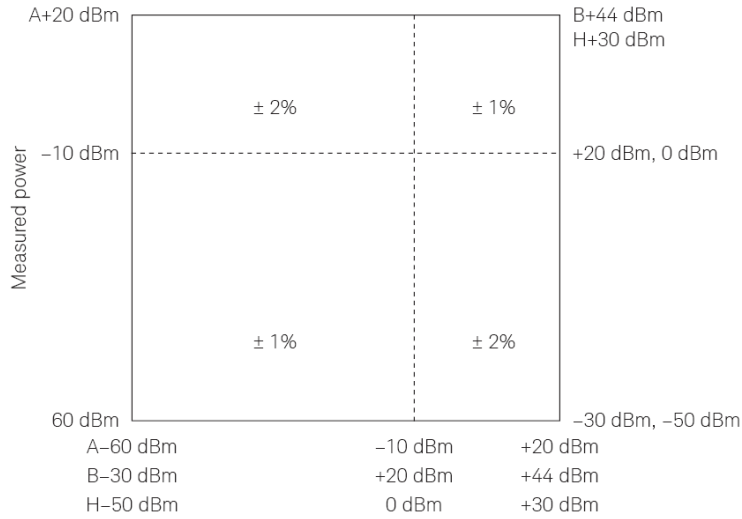

Figure 2. Relative mode power measurement linearity with an EPM Series power meter, at 25 °C ± 10 °C (typical).

Switch point data

The E9300 power sensors have two paths as shown in Table 7. The power meter automatically selects the proper power level path. To avoid unnecessary switching when the power level is near the switch point, switching point hysteresis has been added.

E9300 “A” suffix sensors example:

- Hysteresis causes the low power path to remain selected until approximately -9.5 dBm as the power level is increased, above this power the high-power path will be selected. The high-power path will remain selected until approximately -10.5 dBm is reached as the signal level decreases, below this power the low power path will be selected.

Switching point linearity:

- Typical = $\pm 0.5\%$ (= ± 0.02 dB)

Switching point hysteresis:

- 0.5 dB typical

Table 22. E9300 Series sensor switch point specification.

| E9300 sensor suffix | Conditions ¹⁸ | Zero set | Zero drift ¹⁹ | Measurement noise ²⁰ |
|---------------------|---------------------------------|-------------|--------------------------|---------------------------------|
| A | Lower power path (15 to 75% RH) | 500 pW | 150 pW | 700 pW |
| | Lower power path (75 to 95% RH) | 500 pW | 4,000 pW | 700 pW |
| | High power path (15 to 75% RH) | 500 nW | 150 nW | 500 nW |
| | High power path (75 to 95% RH) | 500 nW | 3000 nW | 500 nW |
| B | Lower power path (15 to 75% RH) | 500 nW | 150 nW | 700 nW |
| | Lower power path (75 to 95% RH) | 500 nW | 4 μ W | 700 nW |
| | High power path (15 to 75% RH) | 500 μ W | 150 μ W | 500 μ W |
| | High power path (75 to 95% RH) | 500 μ W | 3000 mW | 500 μ W |
| H | Lower power path (15 to 75% RH) | 5 nW | 1.5 nW | 7 nW |
| | Lower power path (75 to 95% RH) | 5 nW | 40 μ W | 7 nW |
| | High power path (15 to 75% RH) | 5 μ W | 1.5 μ W | 5 μ W |
| | High power path (75 to 95% RH) | 5 μ W | 30 mW | 5 μ W |

¹⁸ RH is the abbreviation for relative humidity.

¹⁹ Within 1 hour after zero set, at a constant temperature, after a 24-hour warm-up of the power meter with power sensor connected.

²⁰ The number of averages at 16 for normal mode and 32 for x2 mode, at a constant temperature, measured over a one minute interval and two standard deviations.

Calibration factor (CF) and reflection coefficient (Rho)

Calibration factor and reflection coefficient data are provided at frequency intervals on a data sheet included with the power sensor. This data is unique to each sensor. If you have more than one sensor, match the serial number on the certificate of calibration (CoC) with the serial number on the power sensor you are using. The CF corrects for the frequency response of the sensor. The EPM Series power meter automatically reads the CF data stored in the sensor and uses it to make the corrections.

Reflection coefficient (Rho) relates to the SWR according to the following formula:

$$SWR = (1 + \text{Rho}) / (1 - \text{Rho})$$

Maximum uncertainties of the CF data are listed in Tables 12a and 12b. As the E-Series E9300 power sensors have two independent measurement paths (high and low power paths), there are two calibration factor uncertainty tables. The uncertainty analysis for the calibration of the sensors was done in accordance with the ISO Guide. The uncertainty data reported on the calibration certificate is the expanded uncertainty with a 95% confidence level and a coverage factor of 2.

Mechanical characteristic

Mechanical characteristics such as center conductor protrusion and pin depth are not performance specifications. They are, however, important supplemental characteristics related to electrical performance. At no time should the pin depth of the connector be protruding.

Table 23. Calibration factor uncertainties (low power path)

| Frequency | Uncertainty ²¹ (%) (25 °C ± 10 °C) | Uncertainty ²¹ (%) (0 to 55 °C) |
|---|--|---|
| 10 to < 30 MHz | ± 1.8% | ± 2.2% |
| 30 to < 500 MHz (E9304A: 9 kHz to 500 MHz) | ± 1.6% | ± 2.0% |
| 500 MHz to < 1.2 GHz | ± 1.8% | ± 2.5% |
| 1.2 to < 6 GHz | ± 1.7% | ± 2.0% |
| 6 to < 14 GHz | ± 1.8% | ± 2.0% |
| 14 to < 18 GHz | ± 2.0 % | ± 2.2% |

Table 24. Calibration factor uncertainties (high power path)

| Frequency | Uncertainty ²¹ (%) (25 °C ± 10 °C) | Uncertainty ²¹ (%) (0 to 55 °C) |
|---|--|---|
| 10 to < 30 MHz | ± 2.1% | ± 4.0% |
| 30 to < 500 MHz (E9304A: 9 kHz to 500 MHz) | ± 1.8% | ± 3.0% |
| 500 MHz to < 1.2 GHz | ± 2.3% | ± 4.0% |
| 1.2 to < 6 GHz | ± 1.8% | ± 2.1% |
| 6 to < 14 GHz | ± 1.9% | ± 2.3% |
| 14 to < 18 GHz | ± 2.2 % | ± 3.3% |



²¹ The characterized calibration factor should not deviate between periodic calibrations by more than the specified maximum uncertainty in table 12a or 12b. Compliance is confirmed by the deviation being less than or equal to square root (2) times the specified maximum uncertainty.

848xD Series Diode and 8483A Thermocouple Power Sensor Specifications

Calibration factor uncertainties

These thermocouple and diode power sensors provide extraordinary accuracy, stability, and SWR over a wide range of frequencies (100 kHz to 110 GHz) and power levels (-70 to +20 dBm). The 8480 Series sensors in the table do not include discontinued models.

Table 25. Typical root sum of squares (rss) uncertainty on the calibration factor data printed on the power sensor

| Frequency (GHz) | 8483A | 8481D | 8485D | 8487D | R8486D | Q8486D |
|-----------------|-------|-------|-------------------|-------|--------|--------|
| 0.0001 | 1.3 | - | - | - | - | - |
| 0.0003 | 1.2 | - | - | - | - | - |
| 0.001 | 1.1 | - | - | - | - | - |
| 0.003 | 1.2 | - | - | - | - | - |
| 0.01 | 1.2 | - | - | - | - | - |
| 0.03 | 1.2 | - | - | - | - | - |
| 0.05 | 1.2 | - | - | - | - | - |
| 0.1 | 1.2 | - | - | - | - | - |
| 0.3 | 1.2 | - | - | - | - | - |
| 1 | 1.2 | 0.8 | 1.4 | 1.3 | - | - |
| 2 | 1.2 | 0.8 | 1.4 | 1.3 | - | - |
| 4 | - | 0.8 | 1.7 | 1.4 | - | - |
| 6 | - | 0.9 | 1.7 | 1.4 | - | - |
| 8 | - | 1.0 | 1.7 | 1.4 | - | - |
| 10 | - | 1.1 | 1.9 | 1.5 | - | - |
| 12 | - | 1.2 | 1.9 | 1.5 | - | - |
| 14 | - | 1.1 | 2.0 | 1.6 | - | - |
| 16 | - | 1.5 | 2.1 | 1.7 | - | - |
| 18 | - | 1.7 | 2.2 | 1.7 | - | - |
| 22 | - | - | 2.7 | 1.9 | - | - |
| 26.5 | - | - | 2.8 | 2.2 | 3.0 | - |
| 28 | - | - | 2.9 ²² | 2.3 | 3.2 | - |
| 30 | - | - | 3.2 ²² | 2.4 | 3.0 | - |
| 33 | - | - | 3.3 ²² | 2.6 | 3.0 | 4.2 |
| 34.5 | - | - | - | 2.6 | 3.0 | 4.2 |
| 37 | - | - | - | 2.7 | 3.0 | 4.2 |
| 40 | - | - | - | 3.0 | - | 4.2 |
| 42 | - | - | - | 3.2 | - | 4.9 |
| 44 | - | - | - | 2.5 | - | 5.1 |
| 46 | - | - | - | 3.8 | - | 5.5 |
| 48 | - | - | - | 3.8 | - | 5.8 |
| 50 | - | - | - | 5.0 | - | 6.2 |

²² These uncertainties only apply to Option 033.

Maximum SWR and power linearity

Table 26. 8480 Series maximum SWR and power linearity

| Model ²³ | Frequency range | Maximum SWR | Power linearity ²⁴ | Maximum power | Connector type | Weight |
|--|--------------------|--|--|--|---------------------------|--|
| 100 mW sensors, 1 μW to 100 mW (-30 to +20 dBm) | | | | | | |
| 8483A (75-Ohm) | 100 kHz to 2 GHz | 100 to 600 kHz: 1.80 600 kHz to 2 GHz: 1.18 | +10 to +20 dBm: (\pm 3%) | 300 mW avg 10 W pk | Type-N (m) 75 ohm | Net: 0.2 kg (0.38 lb) Shipping: 0.5 kg (1.0 lb) |
| V8486A | 50 to 75 GHz | 50 to 75 GHz: 1.06 | -30 to +10 dBm: (\pm 1%) +10 to +20 dBm: (\pm 2%) | 200 mW avg 40 W pk (10 μ s per pulse, 0.5% duty cycle) | Waveguide flange UG-385/U | Net: 0.4 kg (0.9 lb) Shipping: 1 kg (2.1 lb) |
| W8486A | 75 to 110 GHz | 75 to 110 GHz: 1.08 | (\pm 2%) | 200 mW avg 40 W pk (10 μ s per pulse, 0.5% duty cycle) | Waveguide flange UG-387/U | Net: 0.4 kg (0.9 lb) Shipping: 1 kg (2.1 lb) |
| High sensitivity sensors, 100 pW to 10 μW (-70 to -20 dBm) | | | | | | |
| 8481D ²⁵ | 10 MHz to 18 GHz | 10 to 30 MHz: 1.40 30 MHz to 4 GHz: 1.15 4 to 10 GHz: 1.20 10 to 15 GHz: 1.30 15 to 18 GHz: 1.35 | -70 to -20 dBm: (\pm 1%) | 100 mW avg 100 mW pk | Type-N (m) | Net: 0.16 kg (0.37 lb) Shipping: 0.9 kg (2.0 lb) |
| 8485D ²⁵ | 50 MHz to 26.5 GHz | 0.05 to 0.1 GHz: 1.19 0.1 to 4 GHz: 1.15 4 to 12 GHz: 1.19 12 to 18 GHz: 1.25 18 to 26.5 GHz: 1.29 | -70 to -20 dBm: (\pm 2%) | 100 mW avg 100 mW pk | APC-3.5 mm (m) | Net: 0.2 kg (.38 lb) Shipping: 0.5 kg (1.0 lb) |
| Option 8485D-033 | 50 MHz to 33 GHz | 26.5 to 33 GHz: 1.35 | -70 to -20 dBm: (\pm 2%) | 100 mW avg 100 mW pk | APC-3.5 mm (m) | Net: 0.2 kg (0.38 lb) Shipping: 0.5 kg (1.0 lb) |
| 8487D ²⁵ | 50 MHz to 50 GHz | 0.05 to 0.1 GHz: 1.19 0.1 to 2 GHz: 1.15 2 to 12.4 GHz: 1.20 12.4 to 18 GHz: 1.29 18 to 34 GHz: 1.37 34 to 40 GHz: 1.61 40 to 50 GHz: 1.89 | -70 to -20 dBm: (\pm 2%) | 100 mW avg 100 mW pk 10 W μ s per pulse | 2.4 mm (m) | Net: 0.2 kg (0.38 lb) Shipping: 0.5 kg (1.0 lb) |
| R8486D ²⁵ | 26.5 to 40 GHz | 26.5 to 40 GHz: 1.40 | -70 to -25 dBm: (\pm 3%) -25 to -20 dBm: (\pm 5%) | 100 mW avg, or pk 40 V dc max | Waveguide flange UG-599/U | Net: 0.26 kg (0.53 lb) Shipping: 0.66 kg (1.3 lb) |
| Q8486D ²⁵ | 33 to 50 GHz | 33 to 50 GHz: 1.40 | -70 to -25 dBm: (\pm 3%) -25 to -20 dBm: (\pm 5%) | 100 mW avg, or pk 40 Vdc max | Waveguide flange UG-383/U | Net: 0.26 kg (0.53 lb) Shipping: 0.66 kg (1.3 lb) |

²³ The 8480 Series sensors in the table do not include discontinued models.

²⁴ Negligible deviation except for those power ranges noted.

²⁵ Includes 11708A 30 dB attenuator for calibrating against 0 dBm, 50 MHz power reference. The 11708A is factory set to 30 dB \pm 0.05 dB at 50 MHz, traceable to NIST. SWR < 1.05 at 50 MHz.