

Features

TRIAC Dimmable LED Driver

- Triac –dimmable with leading or trailing edge dimmers
- Class II with SELV output (no earth required)
- Extra-large screw terminals and integrated cable clamps for easy installation
- Power factor corrected >0.95
- Dimming range 1..100%
- Compatible with a wide range of dimmers

RACT09

9 Watt TRIAC Dimmable Single Output



IEC/EN61347 certified
IEC/EN61347-2-13 certified
EN61547 certified
EN62493 certified
EN55015 compliant
CB report

Description

The RACT09-xxx series are low cost, triac-dimmable, constant current 9W LED drivers available with either 350mA, 500mA or 700mA full-range outputs. The drivers are Class II (double insulated) meaning no earth connection is required. The phase angle dimming works with leading or trailing edge dimmers. The RACT09 is suitable for indoor locations up to 50°C ambient temperature and is certified for building into furniture for applications such as dimmable shelf lighting, cove lighting or accent lighting. It is CE marked (LVD + EMC + RoHS), EAC and has IEC61347-1/IEC61347-2-13 CB report certification.

Selection Guide

Part Number	Input Voltage Range [VAC]	Output Voltage Range [VDC]	Output Current [mA]	Efficiency min. @rated load [%]	Output Power [W]
RACT09-350	198-264	13-26	350	80	9
RACT09-500	198-264	9-18	500	81	9
RACT09-700	198-264	7-13	700	76	9

All LED Drivers may not be used without a load. They must be switched on the primary side only. Noncompliance may damage the LED or reduce its lifetime.

Model Numbering



Specifications (measured @ Ta= 25°C, 240VAC, rated load unless otherwise specified)

BASIC CHARACTERISTICS				
Parameter	Condition	Min.	Typ.	Max.
Input Voltage Range		198VAC	230VAC	264VAC
Input Current				60mA
Inrush Current	full load			5A
No Load Power Consumption				1W
Input Frequency Range		50Hz		60Hz
Power Factor	full load	0.95		

continued on next page

Specifications (measured @ ta= 25°C, 240VAC, rated load unless otherwise specified)

Parameter	Condition	Min.	Typ.	Max.
THD	full load			25%
Start-up Time				500ms
Internal Operating Frequency			60kHz	
Output Ripple Current ⁽¹⁾	RACT09-350 RACT09-500 RACT09-700			175mA 350mA 900mA

Notes:

Note1: Measured at 20MHz BW by using a 12" twisted pair-wire terminated with a 0.1µF and 47µF capacitor parallel across output

REGULATIONS

Parameter	Condition	Value
Output Accuracy		±5% typ.
Load Regulation		5% max.
Line Regulation		5% max.

PROTECTION

Parameter	Condition	Value
Input Fuse		fusible resistor
Short Circuit Protection (SCP)		Latch OFF, auto recovery after fault condition is removed
Over Voltage Protection (OVP)	RACT09-350 RACT09-500 RACT09-700	31VDC max. 25VDC max. 17VDC max. Latch OFF, auto recovery after fault condition is removed
Over Load Protection (OLP)		Latch OFF, auto recovery after fault condition is removed
Over Temperature Protection (OTP)	110°C	Latch OFF, auto recovery after fault condition is removed
Isolation Voltage	I/P to O/P tested for 1 minute	3.75kVAC
Leakage Current		5mA max.

Maximum loading of automatic circuit breakers*

* @ 230VAC, 10hm, 90° phase angle and max. load

Circuit Breaker	Circuit Breaker Current			
	10A	16A	20A	25A
Typ				
B	36	57	69	85
C	57	87	109	134

ENVIRONMENTAL

Parameter	Condition	Value
Operating Temperature Range	without derating @ natural convection 0.1m/s (see graph)	-20°C to +50°C
Max. Case Temperature	at tc point	+80°C max.
Operating Humidity	non-condensing	5-85% RH
IP Rating		IP20
Pollution Degree		PD2
Design Lifetime	+25°C ambient	>30 x 10 ³ hours

continued on next page

Specifications (measured @ Ta= 25°C, 240VAC, rated load unless otherwise specified)

Derating Graph

(@ Chamber and natural convection 0.1 m/s)

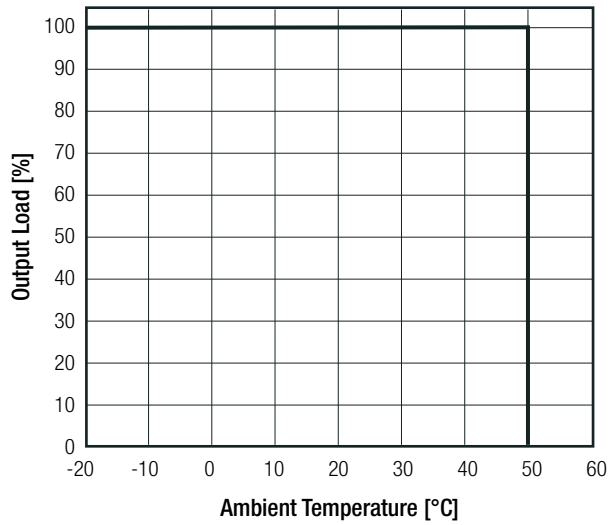

SAFETY AND CERTIFICATIONS

Certificate Type (Safety)	Report Number	Standard
Lamp controlgear Part 1: General and safety requirements (CB Scheme)	325797	IEC61347-1:2007 2nd Edition + A2:2012
Lamp controlgear Part 2-13: Particular requirements for d.c. or a.c. supplied electronic controlgear for LED modules (CB Scheme)	325797	IEC61347-2-13:2014 2nd Edition
Lamp controlgear Part 1: General and safety requirements (LVD)		EN61347-1:2015
Lamp controlgear Part 2-13: Particular requirements for d.c. or a.c. supplied electronic controlgear for LED modules (LVD)		EN61347-2-13:2014 + A1:2017
Lamp controlgear Part 1: General and safety requirements	325797	EN61347-1:2008 + A2:2013
Lamp controlgear Part 2-13: Particular requirements for d.c. or a.c. supplied electronic controlgear for LED modules	325797	EN61347-2-13:2014
EAC	RU-AT.49.09571	TP TC 004/2011
RoHS 2+		RoHS 2011/65/EU + AM2015/863
EMC Compliance	Condition	Standard / Criterion
Limits and methods of measurement of radio disturbance characteristics of electrical lighting and similar equipment	305985	EN55015:2013 + A1:2015
Equipment for general lighting purposes – EMC immunity requirements		EN61547:2009
Assessment of lighting equipment related to human exposure to electromagnetic fields		EN62493:2015
ESD Electrostatic discharge immunity test	Air ±8kV, Contact ±4kV	EN61000-4-2:2009, Criteria A
Radiated, radio-frequency, electromagnetic field immunity test	3V/m	EN61000-4-3:2006 + A2:2010, Criteria A
Fast Transient and Burst Immunity	AC Power Port: ±1kV DC Power Port: ±0.5kV	EN61000-4-4:2012, Criteria A
Surge Immunity	AC Power Port: ±0.5kV	EN61000-4-5:2014, Criteria A
Immunity to conducted disturbances, induced by radio-frequency fields	3V/m	EN61000-4-6:2014, Criteria A
Voltage Dips and Interruptions	Voltage Dips >95%	EN61000-4-11:2004, Criteria B
Voltage Dips and Interruptions	Voltage Dips 30%	EN61000-4-11:2004, Criteria B
Limits of Harmonic Current Emissions		EN61000-3-2:2014, Class C
Limits of Voltage Fluctuations & Flicker		EN61000-3-3:2013, Clause 5

Specifications (measured @ Ta= 25°C, 240VAC, rated load unless otherwise specified)

DIMENSION and PHYSICAL CHARACTERISTICS

Parameter	Type	Value
Material	case PCB	plastic (UL94V-2) FR4 (UL94V-0)
Package Dimension (LxWxH)		109.0 x 40.0 x 22.0mm
Package Weight		70g typ.

Dimensions Drawing (mm)

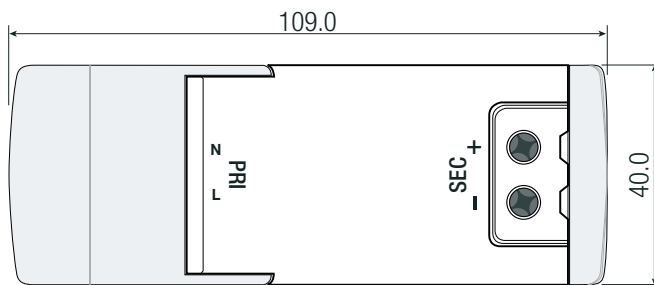
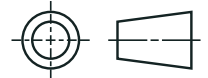

wire stripping length: 6-7mm
recommended tightening torque: 0.25Nm
tc= case temperature measuring point
FC= fixing centers
Tolerance: xx.x= ±1.0mm
xx.xx= ±0.5mm

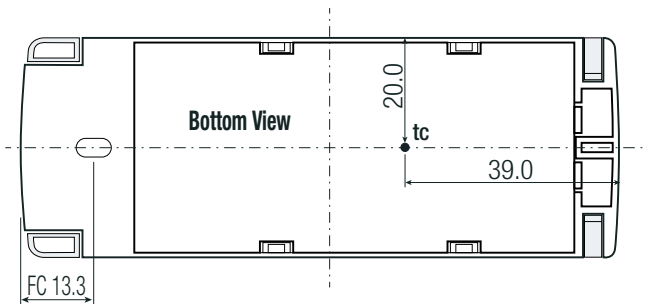
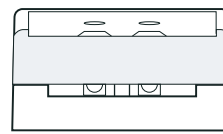
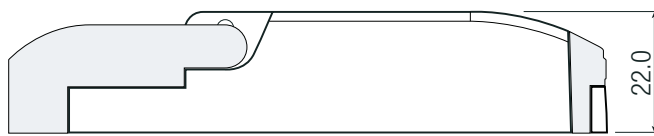

Connection via Screw Terminal

Function	Solid Wire	Stranded Wire ⁽²⁾	AWG
VAC in (N)	0.75-2.5mm ²	0.75-2.5mm ²	20-14
VAC in (L)	0.75-2.5mm ²	0.75-2.5mm ²	20-14
LED+	0.5-2.5mm ²	0.5-2.5mm ²	21-14
LED-	0.5-2.5mm ²	0.5-2.5mm ²	21-14

without cable cover's

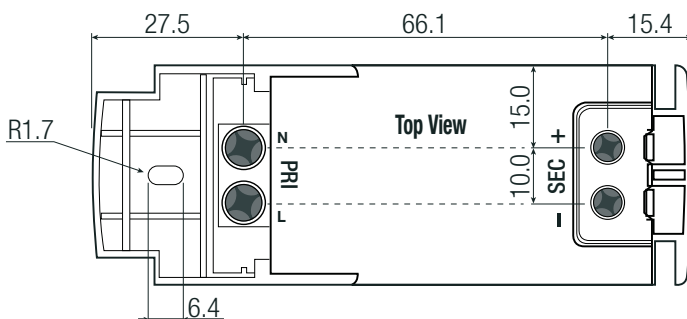

Notes:

Note2: The use of sleeve or ferrule terminations is recommended