

SERPAC RB33X06Y08Y 2

Electronic Enclosures

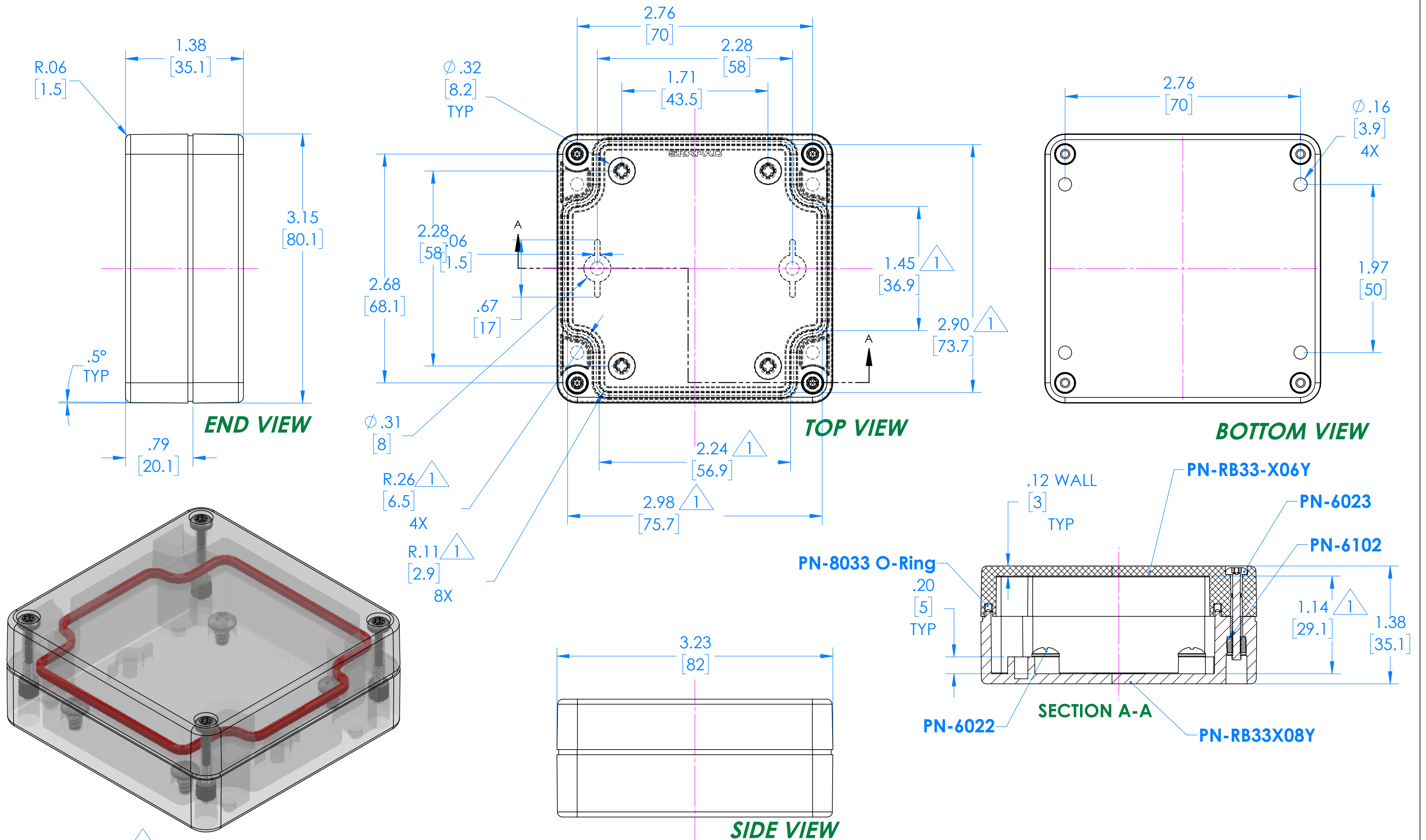

RB33X06C28C 2
 (Part shown, no material (X) specified)

PN	Description
RB33-X06Y	(1) RB33-X06Y, Top
RB33X08Y	(1) RB33X08Y, Bottom
8033	(1) RB33 O-Ring
6023	(4) #4-40 Torx 10 Hd Screw
6022	(4) #10 High/Low Pan Hd x 1/4"
6102	(4) #4-40 Threaded Insert

- 1 =INTERIOR DIMENSIONS (@ BOTTOM)
- 2 =STANDARD COLORS (Y) ARE: BLACK (B), CLEAR (C) AND GRAY (G)
 TOPS AND BOTTOMS ALL POSSIBLE COMBINATIONS AVAILABLE
 STANDARD MATERIALS (X) IS: POLYCARBONATE (P)

-Watertight enclosure meets or exceed Nema 4 and or IP67.

DIMENSIONS in Inch [mm]

RB33 Circuit Board (Fits all Parts starting with RB33)

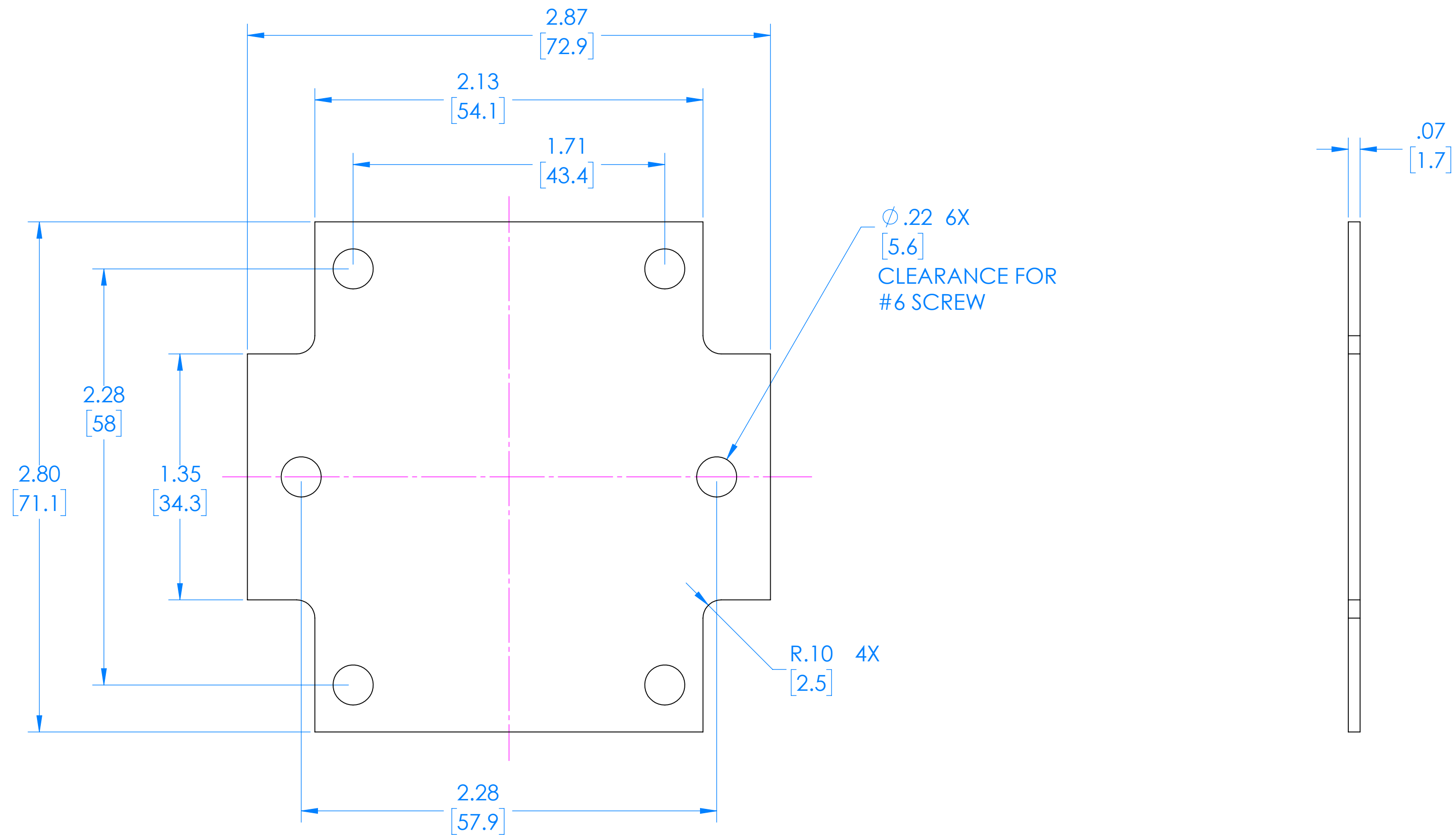

(REFERENCE ONLY)