

SERPAC RBF53X06Y28Y 2

Electronic Enclosures

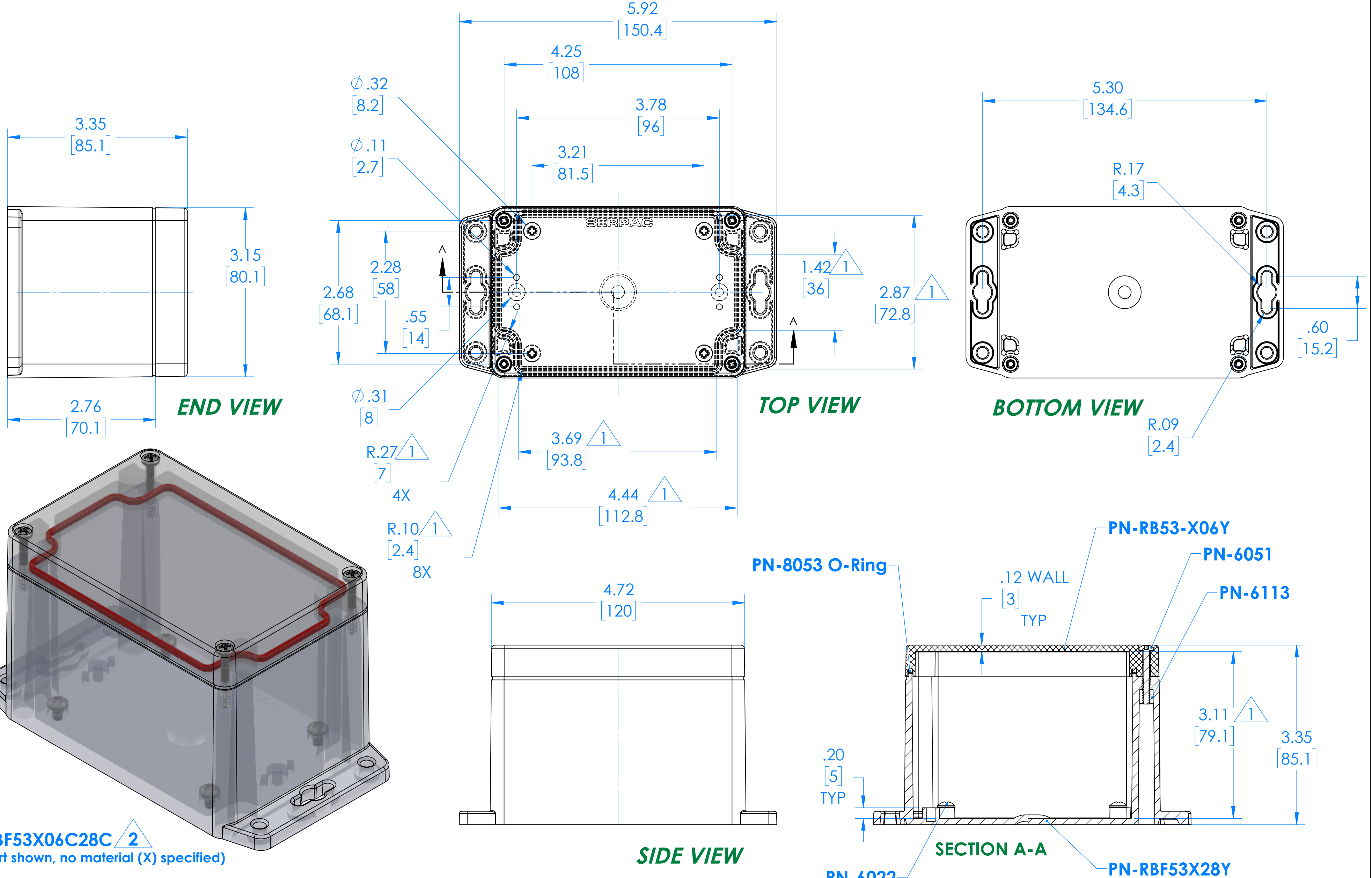

RBF53X06C28C 2
 (Part shown, no material (X) specified)

PN	Description
RB53-X06Y	(1) RB53 06, Top
RBF53X28Y	(1) RBF53 28, Bottom
8053	(1) RB53 O-Ring
6051	(4) #6-32 Combo Hd captive Screw
6022	(4) #10 High/Low Pan Hd x 1/4"
6113	(4) #6-32 Threaded Insert

1 =INTERIOR DIMENSIONS (@ BOTTOM)
2 =STANDARD COLORS (Y) ARE: BLACK (B), CLEAR (C) AND GRAY (G)
 TOPS AND BOTTOMS ALL POSSIBLE COMBINATIONS AVAILABLE
 STANDARD MATERIALS (X) IS: POLYCARBONATE (P)

DIMENSIONS in Inch [mm]

-Watertight enclosure meets or exceed Nema 4 and or IP67.

RBF53 Circuit Board (Fits all Parts starting with RBF53)

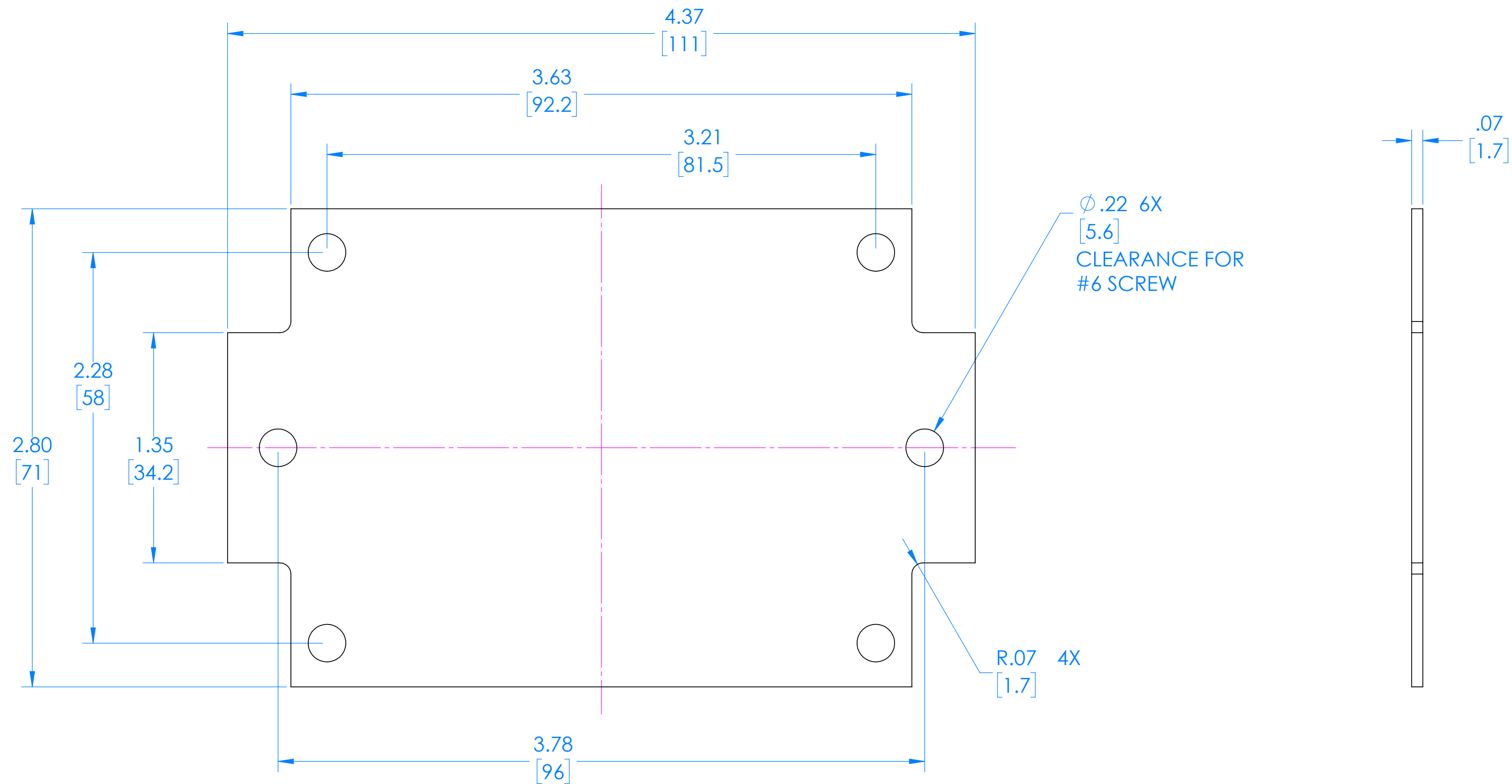

(REFERENCE ONLY)