

Tilt Sensor Switch

Item No.	RBS311113	Description	Photoelectric	Version	12
Page	1 of 10		Publish Date	May. 25, 2018	

● FUNCTIONS

1. Tilt Angles: 15° within a 360° radius.
2. Suitable to vertical PCB.
3. Vibration Detecting

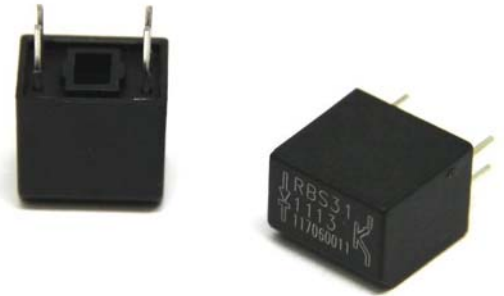

● APPLICATIONS

1. Rotation detection for LCD monitor
2. Automatically shut off for home appliances
3. Automatically shut off for Sporting equipment
4. Automatically shut off for motorbike
5. Alarm system
6. Anti-theft / Anti-tamper devices
7. Being motion detection (personal locator)
8. Wake up systems for power saving, such like remote controllers
9. Earthquake Detecting



Tilt Sensor Switch

Item No.	RBS311113	Description	Photoelectric	Version	12
Page	2 of 10		Publish Date	May. 25, 2018	

● FEATURES

1. Housing made of high insulation plastic material, free from electric conduction and rust problem.
2. Detecting with photo transistors, generating highly reliable and stable signals.
3. All plastic materials subject to industrial purpose, resist high temperature and meet fireproof function.
4. Simple ON and OFF signals, easy for design.
5. RoHS compliance, an ideal substitute for mercury switch.
6. A more economical tilt and vibration detection option than IC design solution.
7. All made in Taiwan and examined before shipment.

● PATENTS

1. Taiwan Patent No. I 310952
2. Taiwan Patent No. M 450817
3. U.S.A Patent No. US 6,800,841 B1
4. U.S.A Patent No. US 7,402,791 B2
5. China Patent No. ZL 200610083013.5
6. China Patent No. ZL 200820126206.9
7. China Patent No. ZL 201220539712.7
8. Japan Patent No. 4384217
9. Japan Patent No. 3148127



Tilt Sensor Switch

Item No.	RBS311113	Description	Photoelectric	Version	12
Page	3 of 10		Publish Date	May. 25, 2018	

● DIMENSIONS / OPERATION / P.C.B. LAYOUT (Unit: mm, Tolerance: ±0.25mm)

Fig. 1

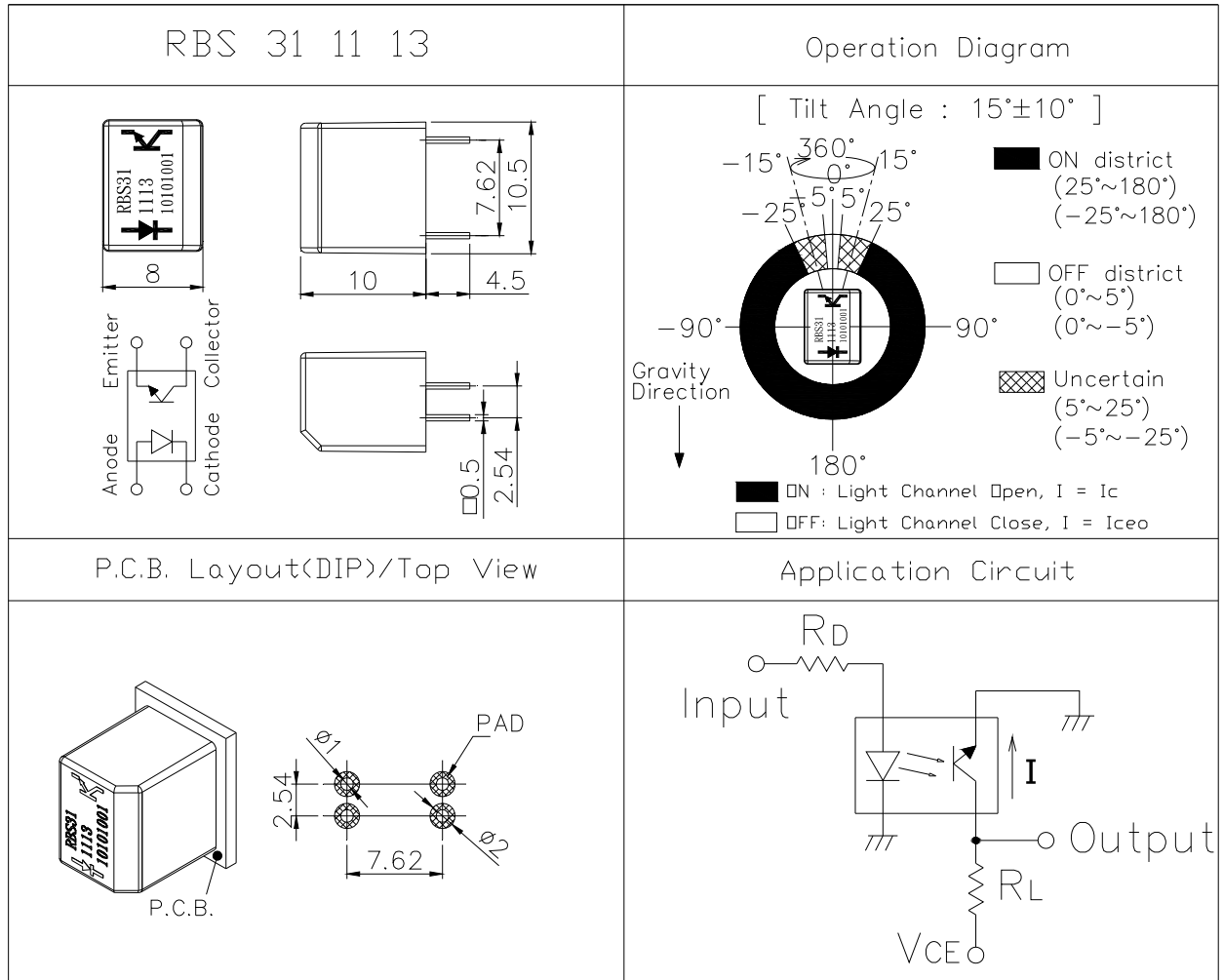

Tilt Sensor Switch

Item No.	RBS311113	Description	Photoelectric	Version	12
Page	4 of 10		Publish Date	May. 25, 2018	

● Current/Voltage Suggested

Input Current (mA)	Operating Voltage (V)	Conditions
10	3.3	$V_{CE}=3.3V$ $R_D=200\text{ ohm}$ $R_L=33K\text{ ohm}$
10	5	$V_{CE}=5V$ $R_D=390\text{ ohm}$ $R_L=33K\text{ ohm}$

* Please refer to above Application Circuit for designing electrical circuit.

● Absolute Maximum Rating ($T_a=25^{\circ}C$)

Item		Symbol	Rating	Unit
Input	Power Dissipation	P_d	75	mW
	Reverse Voltage	V_R	5	V
	Forward Current	I_F	50	mA
	Peak Forward Current (*1)	I_{FP}	1	A
Output	Collector Power Dissipation	P_C	100	mW
	Collector Current	I_C	20	mA
	C-E Voltage	V_{CEO}	30	V
	E-C Voltage	V_{ECO}	5	V
Operating Temperature		T_{opr}	-25~+85	$^{\circ}C$
Storage Temperature		T_{stg}	-40~+85	$^{\circ}C$
Soldering Temperature (*2)		T_{sol}	260	$^{\circ}C$

(*1) $t_w=100\ \mu\text{Sec.}$ 、 $T=10\ \text{mSec.}$

(*2) $t=5\ \text{Sec}$



Tilt Sensor Switch

Item No.	RBS311113	Description	Photoelectric	Version	12
Page	5 of 10		Publish Date	May. 25, 2018	

● Electrical Optical Characteristics (Ta=25°C)

Parameter	Symbol	Condition	Min.	Typ.	Max.	Unit
Forward Voltage	V_F	$I_F=20mA$	-	1.2	1.5	V
Reverse Current	I_R	$V_R=5V$	-	-	10	μA
Peak Wavelength	λ_p	$I_F=10mA$		940		nm
Dark Current	I_{ceo}	$V_{CE}=10V$	-	-	2	μA
C-E Saturation Voltage	$V_{CE(sat)}$	$I_C=0.25mA$ $I_F=20mA$	-	-	0.4	V
Light Current	I_C	$V_{CE}=5V$ $I_F=20mA$	0.5	5	-	mA
Rise Time	T_r	$I_C=0.8mA$ $V_{CC}=30V$	-	5	-	μsec
Fall Time	T_f	$R_L=1K\Omega$	-	5	-	μsec
Operation Diagram	θ	Fig. 1	5	15	25	°



Tilt Sensor Switch

Item No.	RBS311113	Description	Photoelectric	Version	12
Page	6 of 10		Publish Date	May. 25, 2018	

● Typical Electrical / Optical Characteristics Curves (Ta=25°C)

Fig.1 Power Dissipation vs. Ambient Temperature

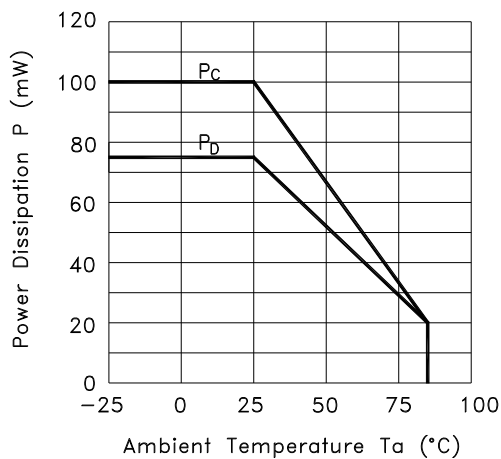

Fig.2 Forward Current vs. Forward Voltage

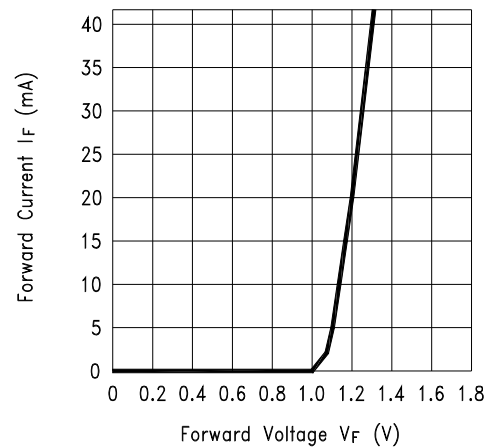

Fig.3 Collector Current vs. Collector-emitter Voltage

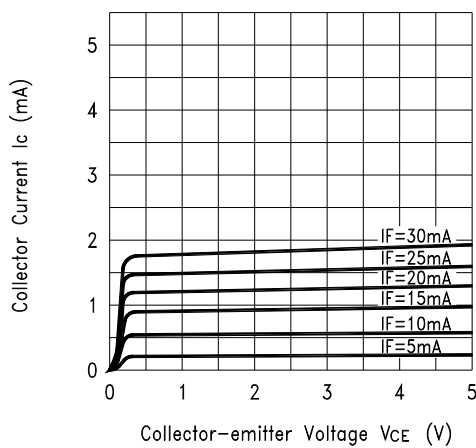
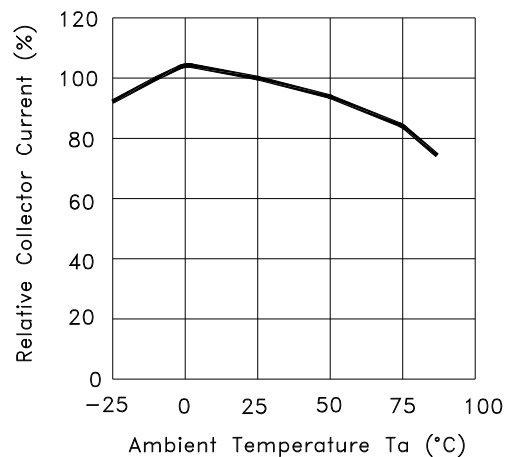

Fig.4 Collector Current vs. Ambient Temperature



Tilt Sensor Switch

Item No.	RBS311113	Description	Photoelectric	Version	12
Page	7 of 10		Publish Date	May. 25, 2018	

Fig.5 Collector-emitter Saturation Voltage vs. Ambient Temperature

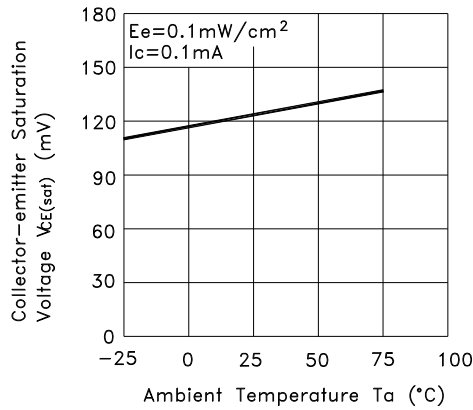

Fig.6 Response Time vs. Load Resistance

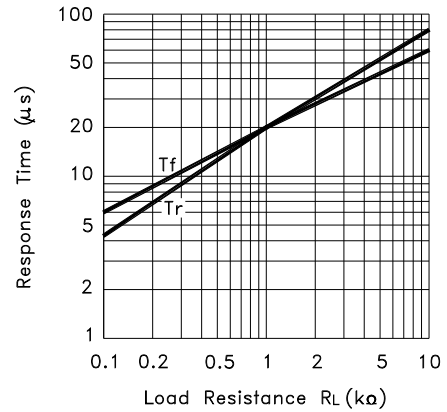
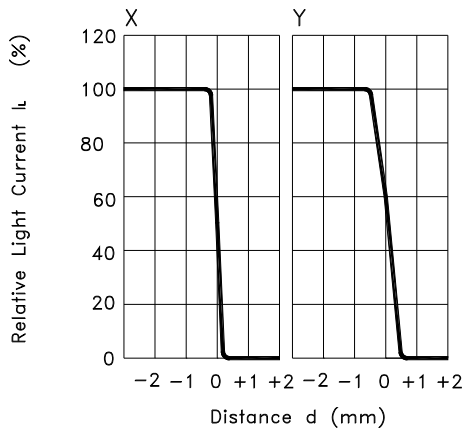
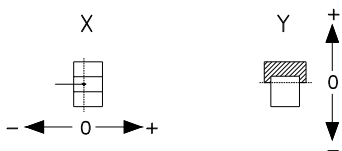

Fig.7 Sensing Position Characteristics (Typical)



(Center of Optical axis)



Test Circuit for Response Time

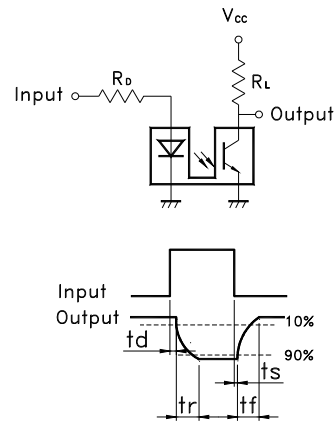

Tilt Sensor Switch

Item No.	RBS311113	Description	Photoelectric	Version	12
Page	8 of 10		Publish Date	May. 25, 2018	

● RELIABLE TEST ITEMS

Reliable Test for RBS311113

	Test Item	Test Content
1	Operation Temperature	-25°C ~ 85°C
2	Storage Temperature	-40°C ~ 85°C
3	Humidity	40 °C / 95 %RH
4	Mechanical Life	2Hz, horizontal 1,000,000 times
5	Electrical Life	I _F =20 mA, V _{CE} =5 V TIME: 30,000 hrs

● SOLDERING CONDITION

Following soldering conditions are for reference only, please use soldering information that solder paste manufacturer recommends.

Condition	Soldering Temperature	Soldering Time	Wattage of Manual Soldering	Type
Suitable Production Process				
Wave Soldering	260±5°C	< 5 seconds max.	-	DIP
Manual Soldering	300±5°C	< 3 seconds max.	30W or Temperature-controlled manual soldering	DIP



Tilt Sensor Switch

Item No.	RBS311113	Description	Photoelectric	Version	12
Page	9 of 10		Publish Date	May. 25, 2018	

● PACKAGE

	Part Number	Package	Quantity	Total	Dimension(mm)
1.	RBS311113	IC tube	48 pcs	48 pcs	525L*10W*17.5H
		Inner box	84 tubes	4,032 pcs	539L*130W*130H
		Outer carton	4 boxes	16,128 pcs	551L*285W*288H

※ Package shown as below for reference.

