

Tilt Sensor Switch

Item No.	RBS330213T	Description	Photoelectric	Version	13
Page	1 of 12		Publish Date	Jun. 25, 2018	

● **FUNCTIONS**

1. Tilt Angles: 15° within a 360° radius
2. Suitable for horizontal PCB
3. Vibration Detecting

● **APPLICATIONS**

1. Automatically shut off for home appliances
2. Automatically shut off for Sporting equipment
3. Alarm system
4. Anti-theft / Anti-tamper devices
5. Being motion detection (personal locator)
6. Wake up systems for power saving, such like remote controllers
7. Automatically shut off for motorcycle when tilt
8. Earthquake Detecting



● **FEATURES**

1. Housing made of high insulation plastic material, free from electric conduction and rust problem.
2. Detecting with photo transistors, generating highly reliable and stable signals.
3. All plastic materials subject to industrial purpose, resist high temperature and meet fireproof function.
4. Simple ON and OFF signals, easy for design.
5. RoHS compliance, an ideal substitute for mercury switch.
6. A more economical tilt and vibration detection option than IC design solution.
7. All made in Taiwan and examined before shipment.



Tilt Sensor Switch

Item No.	RBS330213T	Description	Photoelectric	Version	13
Page	2 of 12		Publish Date	Jun. 25, 2018	

● PATENTS

1. Taiwan Patent No. I 310952
2. Taiwan Patent No. M 450817
3. Japan Patent No. 4384217
4. Japan Patent No. 3148127
5. U.S.A. Patent No. US 6,800,841 B1
6. U.S.A. Patent No. US 7,402,791 B2
7. China Patent No. ZL 200610083013.5
8. China Patent No. ZL 200820126206.9
9. China Patent No. ZL 201220539712.7



Tilt Sensor Switch

Item No.	RBS330213T	Description	Photoelectric	Version	13
Page	3 of 12		Publish Date	Jun. 25, 2018	

● DIMENSIONS / OPERATION / P.C.B. LAYOUT (Unit: mm, Tolerance: ±0.25mm)

Fig. 1

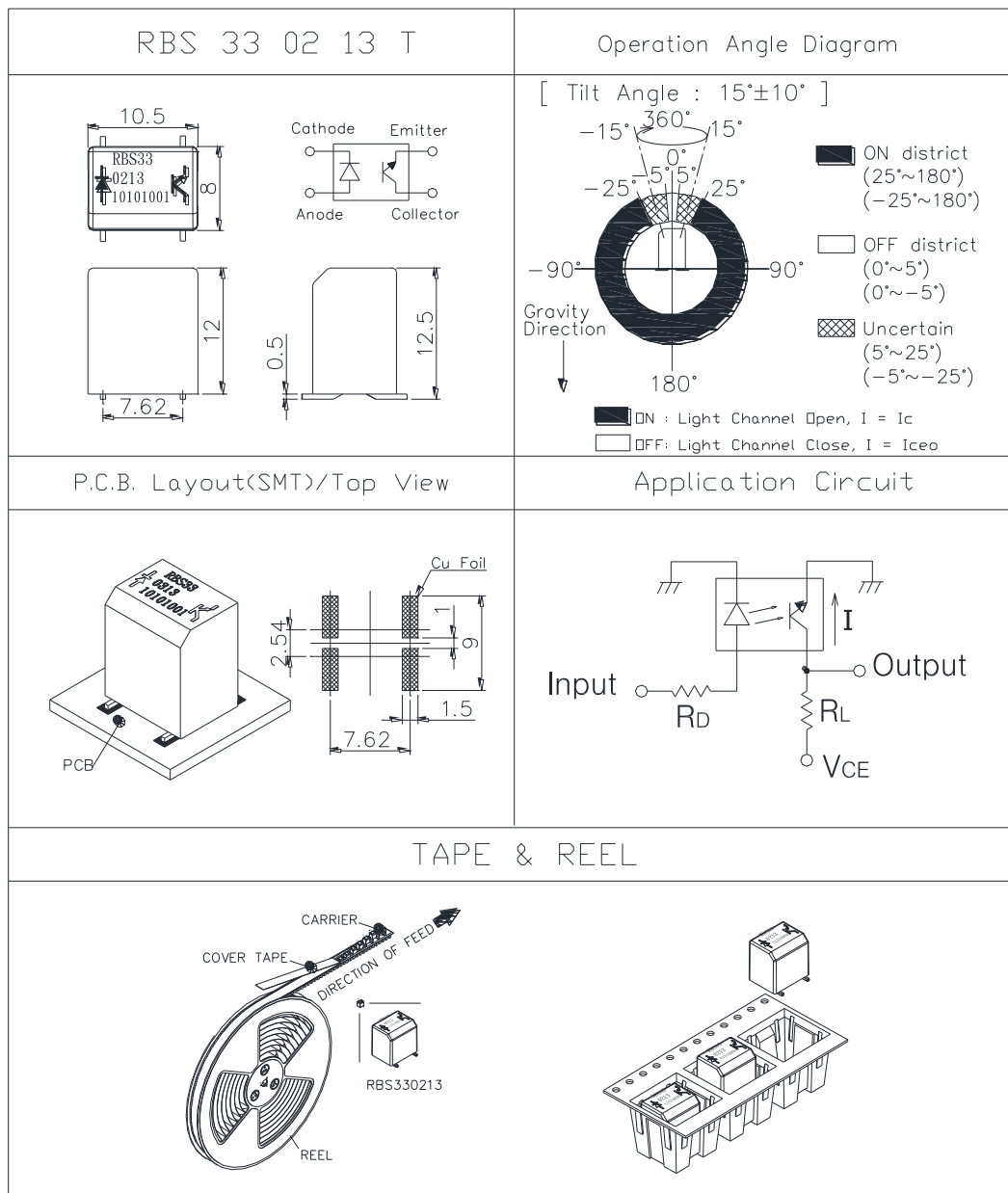

Tilt Sensor Switch

Item No.	RBS330213T	Description	Photoelectric	Version	13
Page	4 of 12		Publish Date	Jun. 25, 2018	

● Current/Voltage Suggested

Input Current (mA)	Operating Voltage (V)	Condition
10	3.3	V _{CE} =3.3V R _D =200 ohm R _L =33K ohm
10	5	V _{CE} =5V R _D =390 ohm R _L =33K ohm

* Please refer to above Application Circuit for designing electrical circuit.

● Absolute Maximum Rating (Ta=25°C)

Item		Symbol	Rating	Unit
Input	Power Dissipation	P _d	75	mW
	Reverse Voltage	V _R	5	V
	Forward Current	I _F	50	mA
	Peak Forward Current (*1)	I _{FP}	1	A
Output	Collector Power Dissipation	P _C	100	mW
	Collector Current	I _c	20	mA
	C-E Voltage	V _{CEO}	30	V
	E-C Voltage	V _{ECO}	5	V
Operating Temperature		T _{opr}	-25~+85	°C
Storage Temperature		T _{stg}	-40~+85	°C
Soldering Temperature (*2)		T _{sol}	260	°C

(*1) t_w=100 uSec., T=10 mSec.

(*2) t=5 Sec



Tilt Sensor Switch

Item No.	RBS330213T	Description	Photoelectric	Version	13
Page	5 of 12		Publish Date	Jun. 25, 2018	

● Electrical Optical Characteristics (Ta=25°C)

Parameter	Symbol	Condition	Min.	Typ.	Max.	Unit
Forward Voltage	V_F	$I_F=20mA$	-	1.2	1.5	V
Reverse Current	I_R	$V_R=5V$	-	-	10	μA
Peak Wavelength	λ_p	$I_F=10mA$		940		nm
Dark Current	I_{ceo}	$V_{CE}=10V$	-	-	2	μA
C-E Saturation Voltage	$V_{CE(sat)}$	$I_C=0.25mA$ $I_F=20mA$	-	-	0.4	V
Light Current	I_c	$V_{CE}=5V$ $I_F=20mA$	0.5	5	-	mA
Rise Time	T_r	$I_C=0.8mA$ $V_{CC}=30V$	-	5	-	μsec
Fall Time	T_f	$R_L=1K\Omega$	-	5	-	μsec
Operation Diagram	θ	Fig. 1	5	15	25	°



Tilt Sensor Switch

Item No.	RBS330213T	Description	Photoelectric	Version	13
Page	6 of 12		Publish Date	Jun. 25, 2018	

● Typical Electrical / Optical Characteristics Curves (Ta=25°C)

Fig.1 Power Dissipation vs. Ambient Temperature

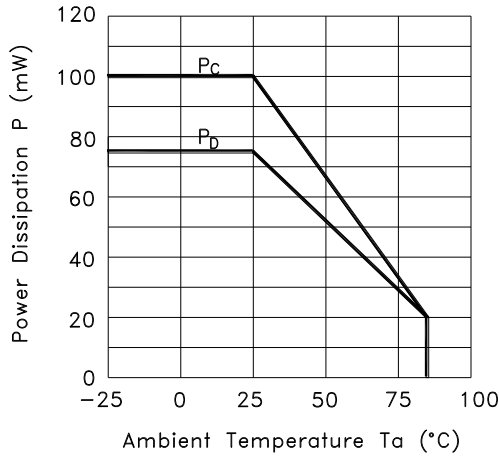

Fig.2 Forward Current vs. Forward Voltage

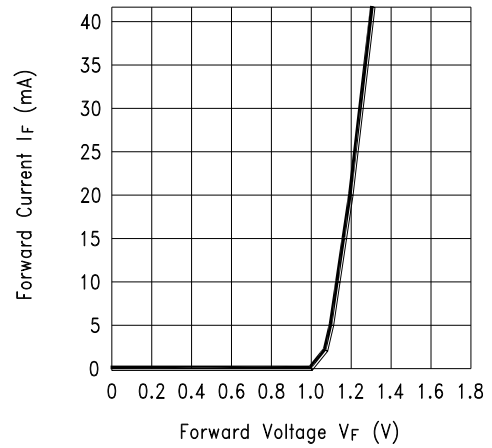

Fig.3 Collector Current vs. Collector-emitter Voltage

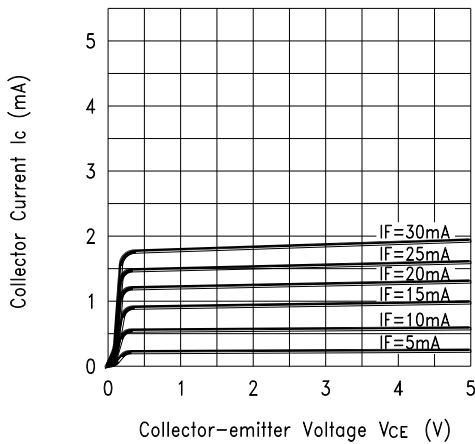
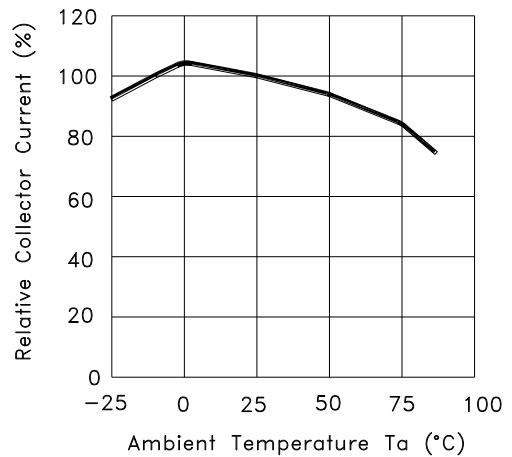

Fig.4 Collector Current vs. Ambient Temperature



Tilt Sensor Switch

Item No.	RBS330213T	Description	Photoelectric	Version	13
Page	7 of 12		Publish Date	Jun. 25, 2018	

Fig.5 Collector-emitter Saturation Voltage vs. Ambient Temperature

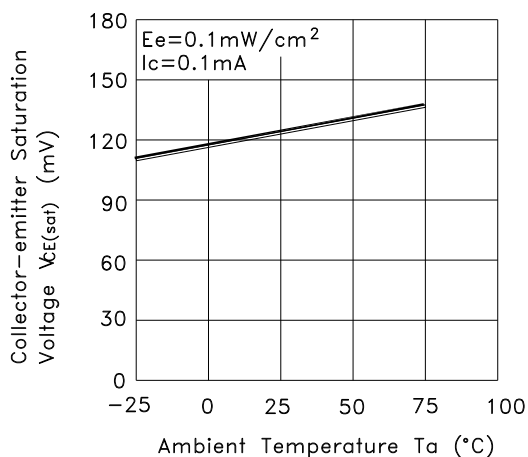

Tilt Sensor Switch

Item No.	RBS330213T	Description	Photoelectric	Version	13
Page	8 of 12		Publish Date	Jun. 25, 2018	

● RELIABLE TEST ITEMS

Reliable Test for RBS330213T

	Test Item	Contents
1	IR Reflow	Peak temp.=255~260°C
2	Operating Temperature	-25°C ~ 85°C
3	Storage Temperature	-40°C ~ 85°C
4	Humidity	40 °C / 95 %RH
5	Mechanical Life	2Hz, horizontal 1,000,000 times
6	Electrical Life	I _F =20 mA, V _{CE} =5 V TIME: 30,000 hrs

● SOLDERING CONDITION

Following soldering conditions are for reference only, please use soldering information that solder paste manufacturer recommends.

Condition	Soldering Temperature	Soldering Time	Wattage of Manual Soldering	Type
Suitable Production Process				
IR Reflow	Please refer to following < Table of classification Reflow profile > and Fig. 2		-	SMD
Manual Soldering	300±5°C	< 3 seconds max.	30W or Temperature-controlled manual soldering	SMD



Tilt Sensor Switch

Item No.	RBS330213T	Description	Photoelectric	Version	13
Page	9 of 12		Publish Date	Jun. 25, 2018	

< Table of classification Reflow profile >

Item	Pb process	Pb free process
Pre-heat and Soak		
Temperature min.(T _{min})	100°C	150°C
Temperature max.(T _{max})	150°C	200°C
Time (T _{min} to T _{max})(ts)	60-120 seconds	60-120 seconds
Average ram-up Rate (T _{max} to T _p)	3°C/second max.	3°C/second max.
Liquidous Temperature (TL)	183°C	217°C
Time at Liquidous (tL)	60-150 seconds	60-150 seconds
Peak package body Temperature (T _p)*	230°C ~235°C *	255°C ~260°C *
Classification temperature(T _c)	235°C	260°C
Time(tp)** within 5 °C of the specified classification temperature (T _c)	20** seconds	30** seconds
Average ram-down Rate (T _p to T _{max})	6°C/second max.	6°C/second max.
Time 25 °C to peak temperature	6 minutes max.	8 minutes max.
* Tolerance for peak profile temperature (T _p) is defined as a supplier minimum and a user maximum.		
** Tolerance for time at peak profile temperature (tp) is defined as a supplier minimum and a user maximum.		



Tilt Sensor Switch

Item No.	RBS330213T	Description	Photoelectric	Version	13
Page	10 of 12		Publish Date	Jun. 25, 2018	

Fig. 2

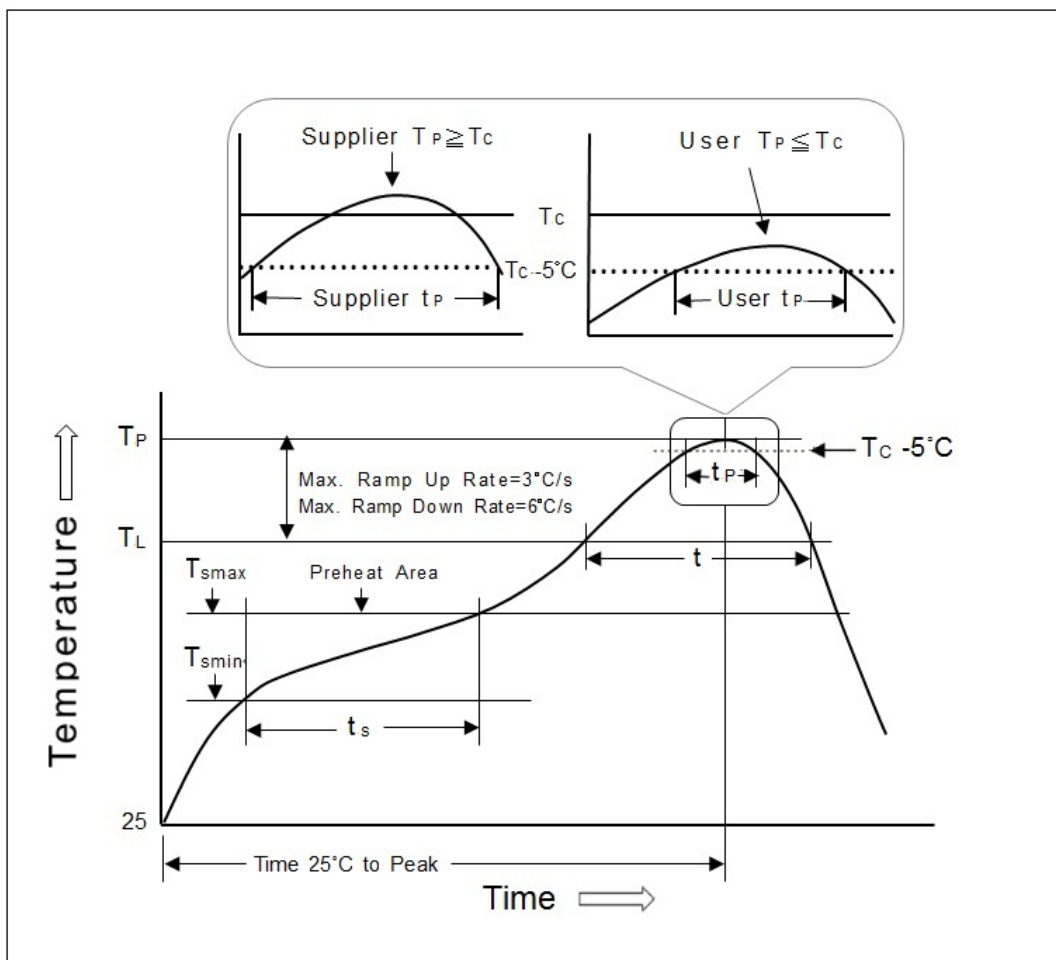

Tilt Sensor Switch

Item No.	RBS330213T	Description	Photoelectric	Version	13
Page	11 of 12		Publish Date	Jun. 25, 2018	

● PACKAGE

	Part Number	Package	Quantity	Total	Dimension (mm)
1.	RBS330213T	Tape & Reel	250 pcs	250 pcs	φ330*25H
		Inner Box	2 Reels	500 pcs	355L*340W*68H
		Carton	10 Boxes	5,000 pcs	703L*364W*380H

※ Package is shown as below for reference.

