

## RC32614A-EVK

Ultra-Low Phase Noise System Synchronizer

The board allows customers to evaluate the Renesas ClockMatrix RC32614A device. This manual will accomplish the following:

- Introduce the board on its power supply and jumper settings
- Describe the input and output connectors for normal operation;
- How to bring up the board by using Timing Commander software GUI;
- How to configure and program the board to generate standard-compliant frequencies

### Board Contents

The RC32614A 144-BGA EVK ships with the following:

- RC32614A 144-BGA EVK Evaluation Board
- USB Type-C cable



Figure 1. RC32614A-EVK Evaluation Board

## Contents

<b>1. Functional Description</b> .....	<b>3</b>
1.1 Board Power Supply.....	3
1.2 Voltage Selection Jumpers.....	3
1.3 GPIO switches, LEDs and Test Points.....	5
1.4 USB Jack.....	5
1.5 I2C between FTDI, CM chip and Onboard EEPROM.....	5
1.6 Output Terminations and Modifications to Use a 1PPS Input.....	5
<b>2. Board Design</b> .....	<b>7</b>
2.1 Schematic Diagram.....	9
<b>3. Working with Timing Commander for Programing/Configuration</b> .....	<b>9</b>
3.1 PC Requirements.....	9
3.2 Using I2C with the Evaluation Board.....	9
3.2.1. FTDI Dongle.....	10
3.3 Using Timing Commander to Control the Board.....	11
3.5 EEPROM Operations using the GUI.....	15
3.5.1. Upload Firmware into the EEPROM.....	15
3.5.2. Verify the EEPROM Programming.....	16
<b>4. Ordering Information</b> .....	<b>17</b>
<b>5. Revision History</b> .....	<b>17</b>

## Figures

Figure 1. RC32614A-EVK Evaluation Board.....	1
Figure 2. Example Power Jumpers Positions for 3.3V, 2.5V and 1.8V on VDDO_Q8 and VDD_Q0.....	4
Figure 3. Input Clock's AC-Coupling and Terminations.....	6
Figure 4. Configuring CLK0 as CMOS to Receive a 1PPS Input.....	6
Figure 5. RC32614 Evaluation Board (Top).....	7
Figure 6. RC32614 Evaluation Board (Bottom).....	8
Figure 7. RC32614-EVK Schematic Block Diagram.....	9
Figure 8. FTDI USB to I2C Dongle.....	10
Figure 9. Cable Connections for FTDI USB to I2C Dongle.....	10
Figure 10. Selecting RC32614 using Personality File Ver. 10.0.0.....	12
Figure 11. Timing Commander GUI with a Settings File Opened.....	12
Figure 12. Setting I2C for Connecting the Board using the GUI.....	13
Figure 13. A Green Band Appears when a Valid Connection is Made.....	13
Figure 14. Reading Firmware Version.....	14
Figure 15. Read Firmware Version of ClockMatrix Chip.....	14
Figure 16. EEPROM Direct Writing using the GUI.....	15
Figure 17. EEPROM Direct Writing Confirmation.....	15
Figure 18. EEPROM Direct Verification using the GUI.....	16
Figure 19. EEPROM Direct Additional Action.....	16
Figure 20. EEPROM Direct Confirmation of Write.....	16

# 1. Functional Description

Use the following diagram to identify various components of the board: Input and output SMA connectors; Power supply jacks and some jumper settings necessary for the board operations. Detailed descriptions are as the following. See Figure 5 for locations.

- **Input SMA Connectors:** There are four differential inputs labeled CLK0/nCLK0~CLK4/nCLK4. Each input clock can be configured differentially (LVDS, PECL 2.5V and PECL 3.3V) or in single-ended format (CMOS).
- **Output SMA Connectors:** There are 10 outputs labeled as Q0/nQ0~Q9/nQ9. Each output clock can be configured differentially (LVDS, LVPECL, or user-defined amplitude) or in single-ended format (LVCMOS – in-phase or out-of-phase). In addition, there are four outputs labeled as Q10A/A10An~ Q10D/A10Dn which can be configured for LVDS, LVPECL or CML (AC-coupled).
- **GPIO switch, LEDs and test points:** There are six GPIOs available. Each GPIO can be set a “low” or “high” level (if control input), displayed with an LED (if output) or connected to a SMA connector (if used as an input clock). Some GPIOs are used to set the chip in a certain working condition on power-up. See GPIO switches, LEDs and Test Points section below for details.
- **USB connector:** a USB-C connector is used to connect the evaluation board to a PC for GUI communications. No power is drawn from USB connector other than to power the FTDI USB chip. (The user must provide power via the power jacks for device operation.)
- **VDDO\_Qx voltage selection jumpers (B):** Each output voltage can be individually supplied with 1.8V, 2.5V or 3.3V. These jumpers are used to select the voltage for the output voltages.
- **Reset button:** a button used to reset the board.
- **OSCI Input connector:** an SMA connector, J3, is provided to optionally supply a clock signal to overdrive the crystal.
- **Optional OCXO/TCXO Reference (F):** an OCXO/TCXO footprint, output at J5. It can be connected to J3 as the wander and jitter reference for the device.
- **EEPROM:** an SO-8 socket is provided to hold an EEPROM device of compatible package. EEPROM is used to store FW and customer configuration data, if needed.

## 1.1 Board Power Supply

The board uses a single +5V supply for its power supplies. When running the board, please set the bench power supply at 5V/2A. The red jack (J1) is positive; the black jack (J1) is the ground.

Multiple LDOs are used to generate 3.3V, 2.5V and 1.8V from the +5V supply.

A 5V power supply with a 2A rating is recommended.

## 1.2 Voltage Selection Jumpers

There are eight headers/jumpers selecting different voltages for different functional blocks of the chip. Each header has their settings labeled in silkscreen – jumping pin 1 and pin 2 will select 3.3V; jumping pin 2 and pin 3 will select 2.5V. No jumper will give 1.8V. The pin nearest to the label is pin 1.

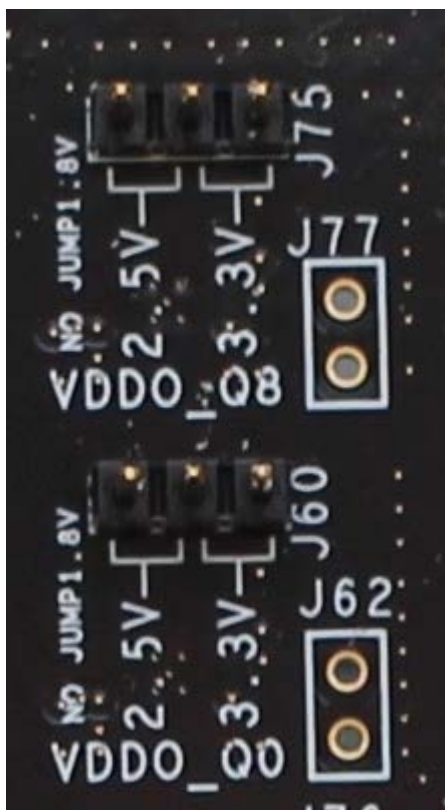

Figure 2. Example Power Jumpers Positions for 3.3V, 2.5V and 1.8V on VDDO\_Q8 and VDD\_Q0

Table 1. Voltage Selection Jumpers

VDDO_Q0	J60
VDDO_Q1	J64
VDDO_Q2	J68
VDDO_Q3	J72
VDDO_Q4	J59
VDDO_Q5	J63
VDDO_Q6	J67
VDDO_Q7	J70
VDDO_Q8	J75
VDDO_Q9	J79
VDDO_Q10	J82
VDD_CLK	J85
VDDD2	J80

Some power rails do not have jumpers since they have a fixed voltage for this device.

### 1.3 GPIO switches, LEDs and Test Points

An 8-bit, 3-position dip switch is used to set the logic levels for 6 GPIOs (GPIO0–4, GPIO9). These are the GPIO levels for each setting and the corresponding LED state:

Table 2. GPIO Settings

Dip Switch Position	GPIO Logic Level	LED
Left	Low	On
Center	High if GPIO is configured as Input High or Low according to the GPIO output setting	High if GPIO is configured as Input High or Low according to the GPIO output setting
Right	High	Off

The switch is in the lower left side of the board as shown in Figure 5.

When the GPIOs are configured as outputs (such as User-Controlled or LOL indicator) or as input clocks, the dip switch for the corresponding GPIO should be placed in the Center position. When used as a GPIO, the LED will indicate the state of the GPIO. The function for each pin is labeled on the board.

### 1.4 USB Jack

This is a USB-C connector to the board. The connection is to control the board. The main power for the board comes from the banana jacks.

### 1.5 I2C between FTDI, CM chip and Onboard EEPROM

There is only one serial bus on this chip, which is used for the device and an EEPROM holding the configuration. The EEPROM is always connected to the I2C bus with the FTDI I2C master and the device.

### 1.6 Output Terminations and Modifications to Use a 1PPS Input

All outputs are terminated with a 100Ω resistor across the output pair. This is the recommended termination regardless of the Voffset and Vswing settings. Since the outputs are dc-coupled, they will support a 1PPS output without any need for rework.

*Note: when connecting the outputs to measurement equipment, use a dc-block to ensure that the output operates at its intended Voffset. Otherwise, the equipment may load the output down and cause degraded performance.*

The following rework must be implemented in order to support a 1PPS **input** clock. All input clocks for this board are ac-coupled and terminated as follows:

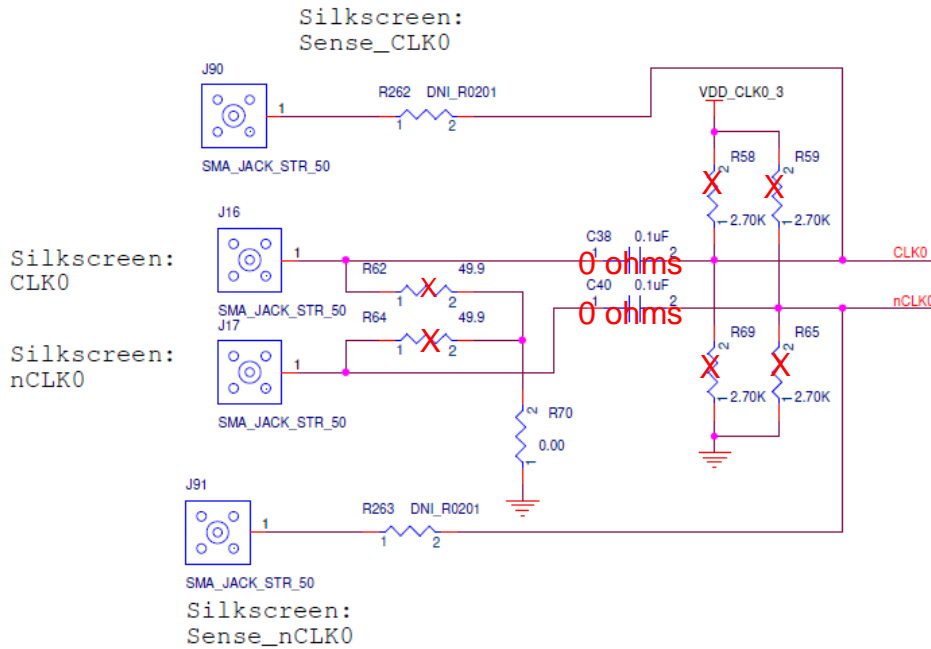

Figure 3. Input Clock's AC-Coupling and Terminations

For a 1PPS input, a single-ended input with DC-coupling is recommended. As such, the populated ac-coupling capacitor must be removed and the input must be configured as LVCMOS, not differential. In Figure 3 above, to make CLK0 supportive of 1PPS input, first configure CLK0 as LVCMOS in Timing Commander (See Figure 4 below).

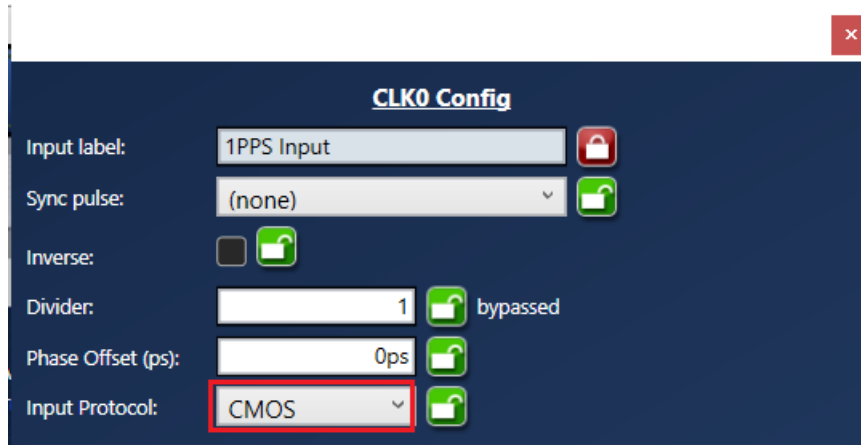

Figure 4. Configuring CLK0 as CMOS to Receive a 1PPS Input

Once in LVCMOS mode, CLK0\_P and CLK0\_N will be two separate LVCMOS inputs instead of a differential pair. To make CLK0\_P receive a 1PPS input, replace C39 with a 0-ohm resistor; in the same time, remove R58 and R69.

## 2. Board Design

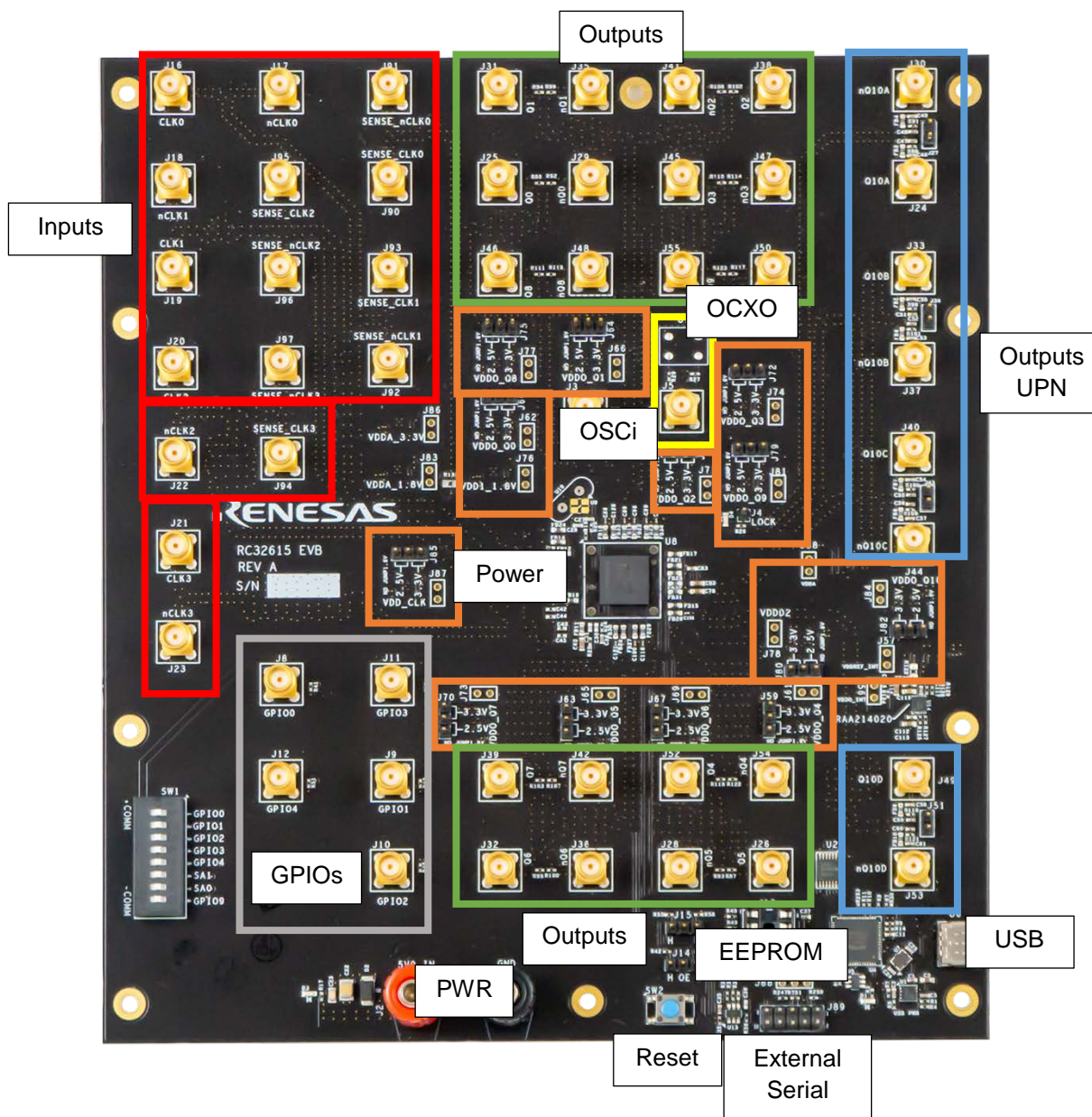

Figure 5. RC32614 Evaluation Board (Top)

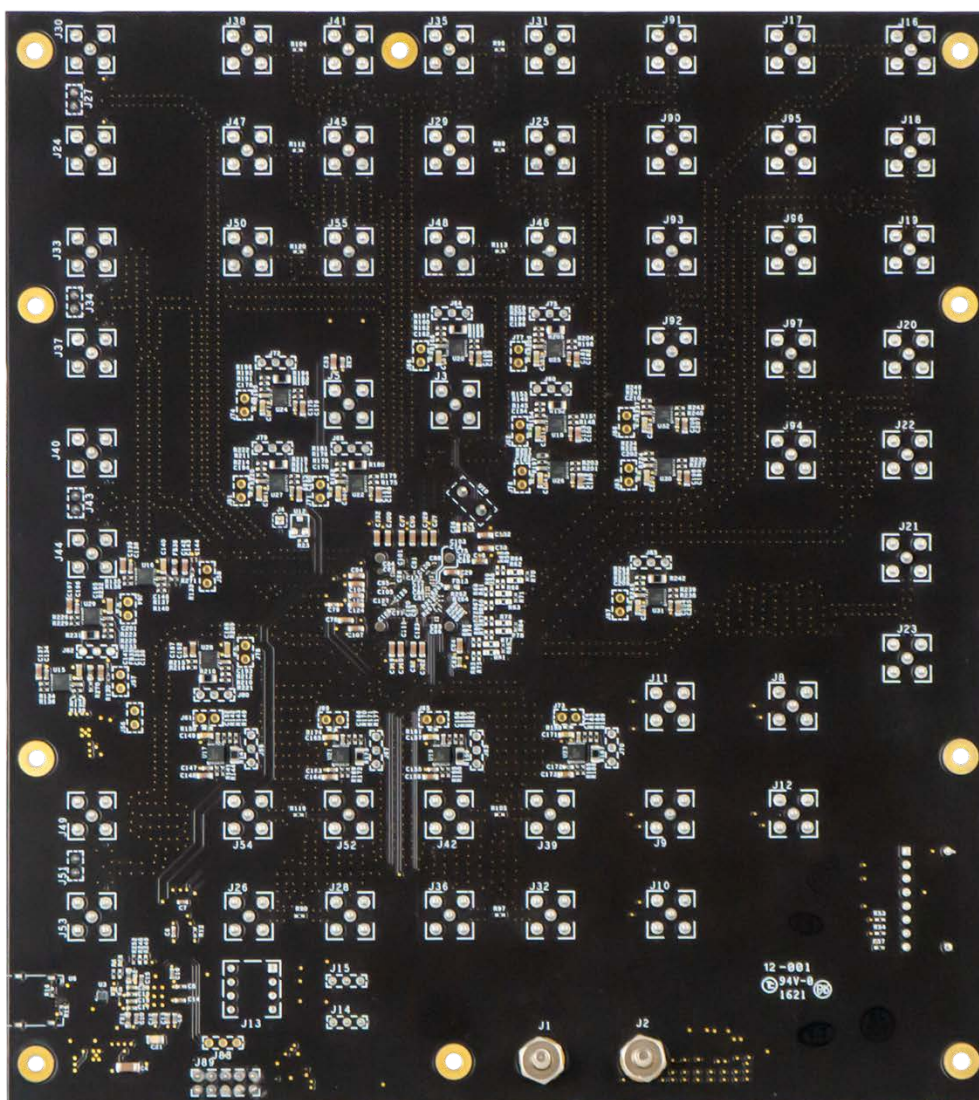

Figure 6. RC32614 Evaluation Board (Bottom)



## 2.1 Schematic Diagram

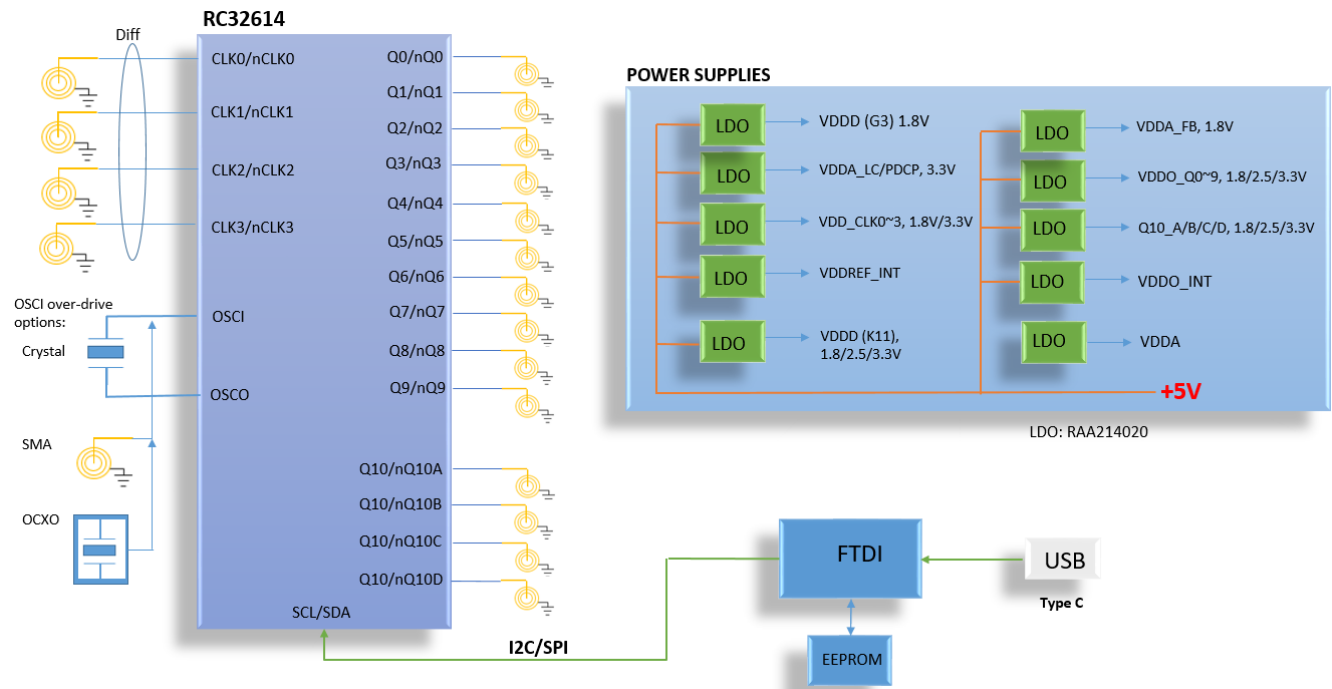

Figure 7. RC32614-EVK Schematic Block Diagram

## 3. Working with Timing Commander for Programming/Configuration

Note: The following sections are best cross-referenced with *ClockMatrix GUI Step-by-Step User Guide*, which is available on the Renesas web site.

The board will configure the device using I2C.

### 3.1 PC Requirements

PC Requirements:

- Renesas Timing Commander (GUI) Software and ClockMatrix RC32614A Personality (available from [ClockMatrix™ Timing Solutions | Renesas](https://www.renesas.com/en/products/programmable-logic/clockmatrix-timing-solutions) under RC32614A on the web)
- USB 2.0 or USB 3.0 interface.
- Windows XP SP3 or later.
- Processor: Minimum 1GHz.
- Memory: Minimum 512MB, recommended 1GB.
- Available Disk Space: Min 600MB (1.5GB 64-bit), recommended 1GB (2GB 64-bit)
- Network access during installation if the .NET framework is not currently installed on the system.

### 3.2 Using I2C with the Evaluation Board

Before proceeding to communicate to ClockMatrix using Timing Commander GUI, two I2C connection methods are introduced:

1. Using the onboard FTDI circuit. The board has onboard FTDI circuitry to translate Timing Commander accesses from USB to I2C port of ClockMatrix. This is to connect the PC to the board through the USB connector. For most applications, the on-board USB to I2C will be used.

2. Using FTDI dongle (C232HM-DDHSL-0 cable). The dongle, picture shown below, has the same FTDI circuit as this board built in it. The great benefit of using this dongle is to enable us to connect to a customer's board and still enjoy all the debugging capabilities the Timing Commander tool has to offer.

### 3.2.1. FTDI Dongle

USB Type-A at PC end and 10 free-wires at the other end.



Figure 8. FTDI USB to I2C Dongle

The free wires are color-coded and numerically indexed as illustrated in Figure 9:

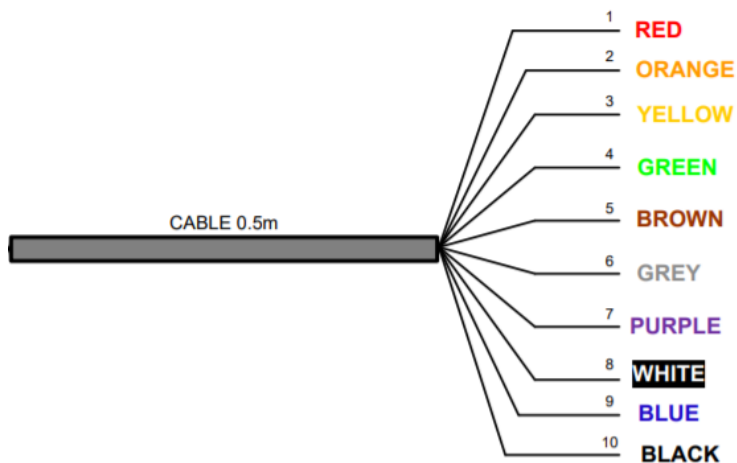

Figure 9. Cable Connections for FTDI USB to I2C Dongle

For using with Timing Commander, only 4 wires are utilized. When connecting to a customer board, connect Orange wire to SCL; tie Yellow wire and Green wire together and connect to SDA; then don't forget about the ground: connect Black wire to customer board GND. Assuming there is a pull-up resistor for SCL and SDA, respectively, on customer board.

Color	Pin Number	Name	Type	Description
Orange	2	SCL	Output	Serial Clock
Yellow	3	SDA	Input/Output	Serial data signal shortened together to create bidirectional data (both yellow and green wires need to be shorted together)
Green	4			

By using FTDI dongle, we can connect to a customer board and use Timing Commander GUI just like working on an Renesas ClockMatrix evaluation board.

### 3.3 Using Timing Commander to Control the Board

Once the default operation is successful, the following steps can be followed to configure and program ClockMatrix chip per your specific application requirements using Timing Commander GUI tools.

1. Power up the board and set the main serial port in I2C mode by GPIO9 = "high". Refer Figure-4 above for the position of GPIO9. Connect the board to PC.
2. Start Timing Commander software. You will see options of "New Setting File" and "Open Setting file". For a new configuration, select "New Setting File".
3. After selecting "New Settings File", a device selection window will pop up. In the window, choose the intended device in the list (RC32614 is selected in this example). Click the button at the lower right corner of the window (red outline) to browse and select the correct personality file – in this example, personality Ver 10.0.0 is selected. Click OK.

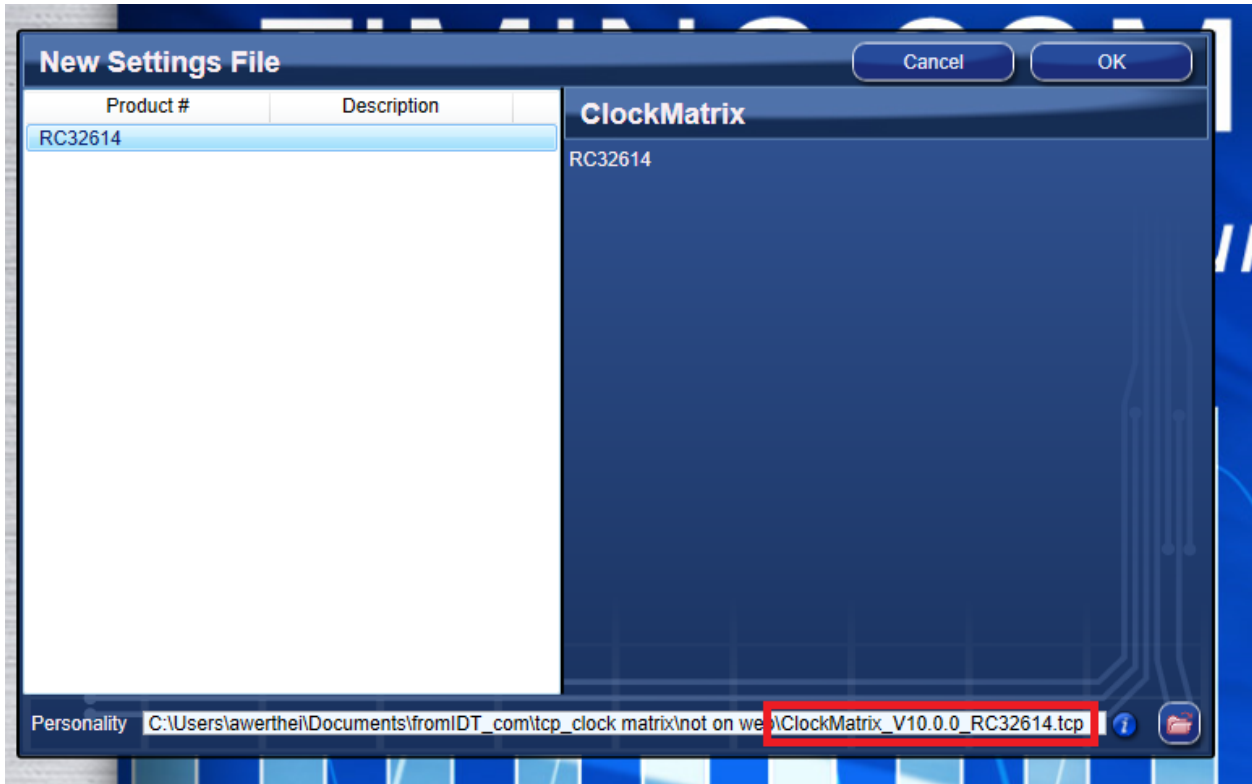

Figure 10. Selecting RC32614 using Personality File Ver. 10.0.0

4. The GUI window with RC32614 block diagram will open for configurations; or if “Open Settings File” is selected in Step 3 above, you will be prompted to browse and select an existing .tcs file and the personality file. When the configuration file is open, all configured values will be displayed, like that shown in Figure 11 below.

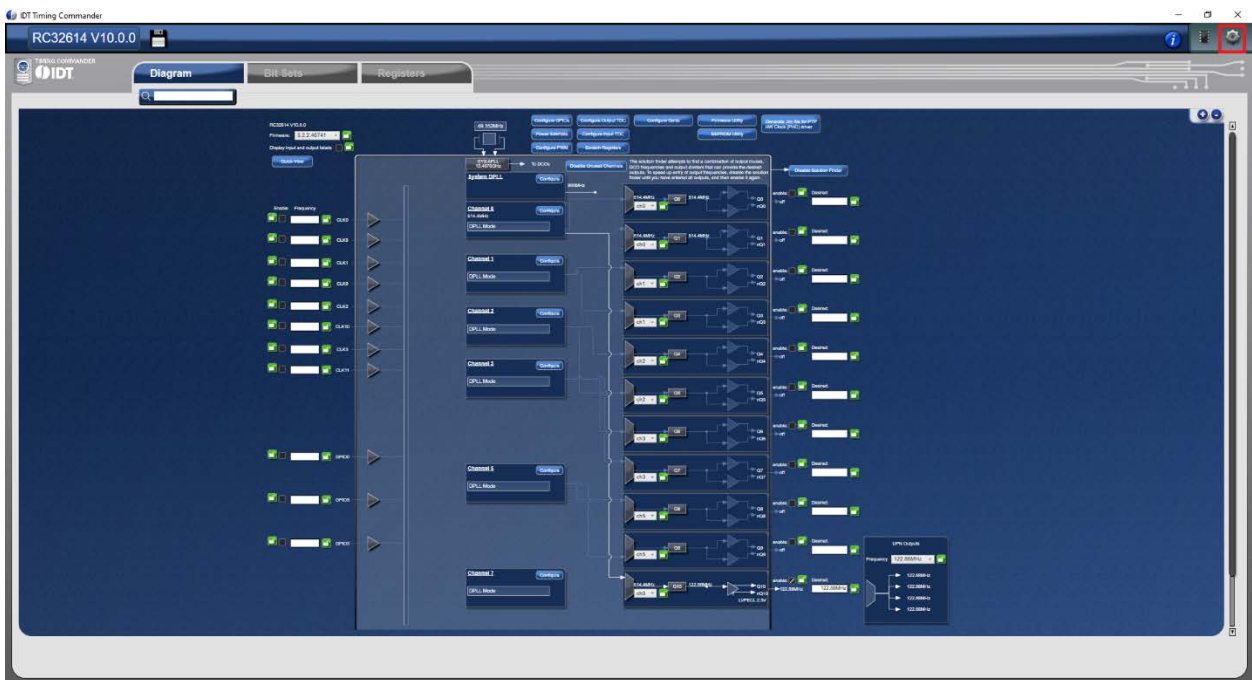

Figure 11. Timing Commander GUI with a Settings File Opened

- In order to connect the board with Timing Commander (PC), click the button (red outline) at the up-right corner of the GUI to set up the communication protocols. After I2C and one-byte addressing are selected, click OK to close the window.

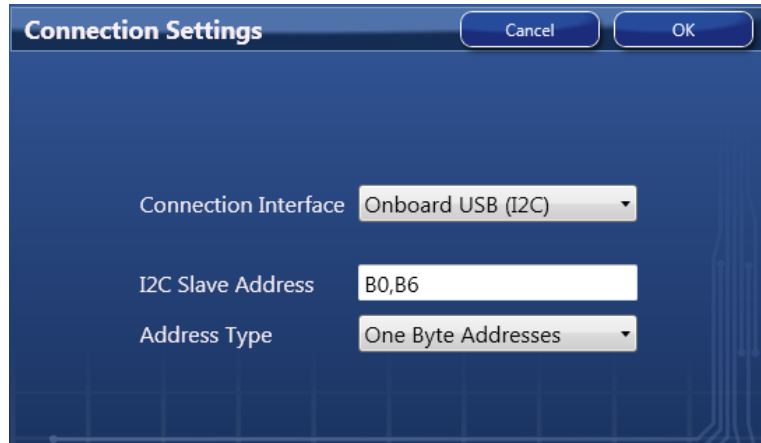

Figure 12. Setting I2C for Connecting the Board using the GUI

- Click the chip symbol at the up-right corner to initiate the connection. The connection is made with a green band appearing at the up-right corner of the window, as shown below.

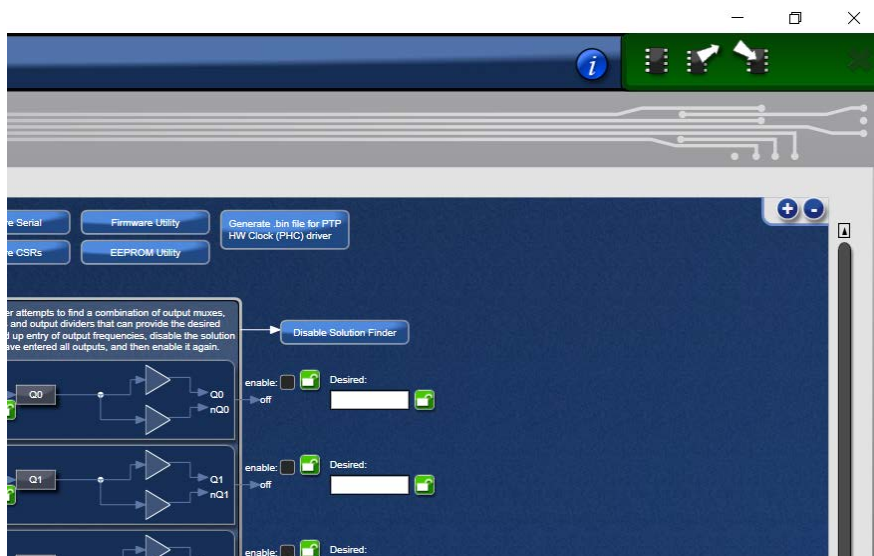

Figure 13. A Green Band Appears when a Valid Connection is Made

- If ClockMatrix chip's firmware, or firmware loaded from EEPROM, has a different version from that in the Personality file, a firmware version mismatch warning message will appear. Click "Close" button to close the message window and a connection is made. This is not expected for the RC32614 devices
- Once the connection is made, the firmware version can be read within GUI. Click "Firmware Utility" button to bring out Firmware Utility window, as shown below.

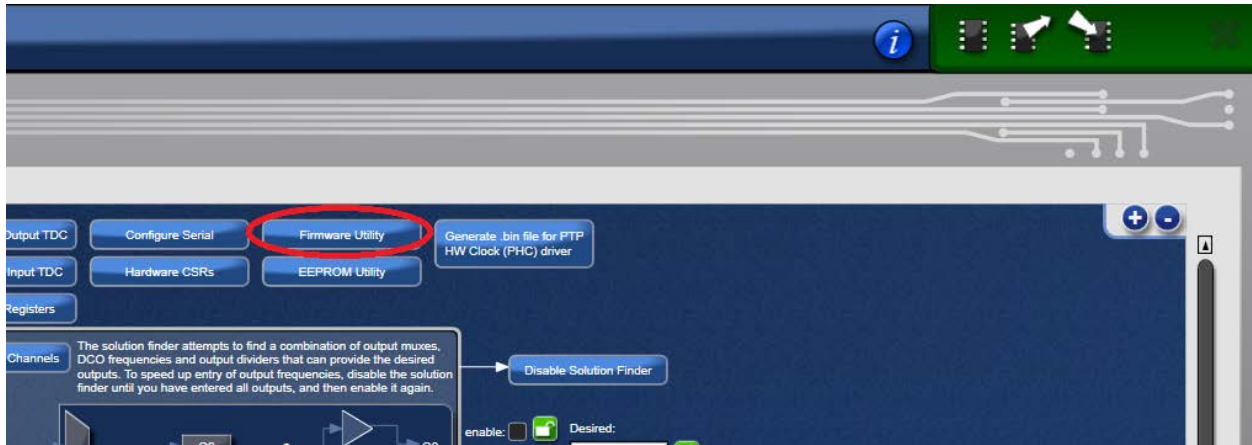

Figure 14. Reading Firmware Version

9. Within Firmware Utility window, click “Get Firmware Version” button will read the firmware version.

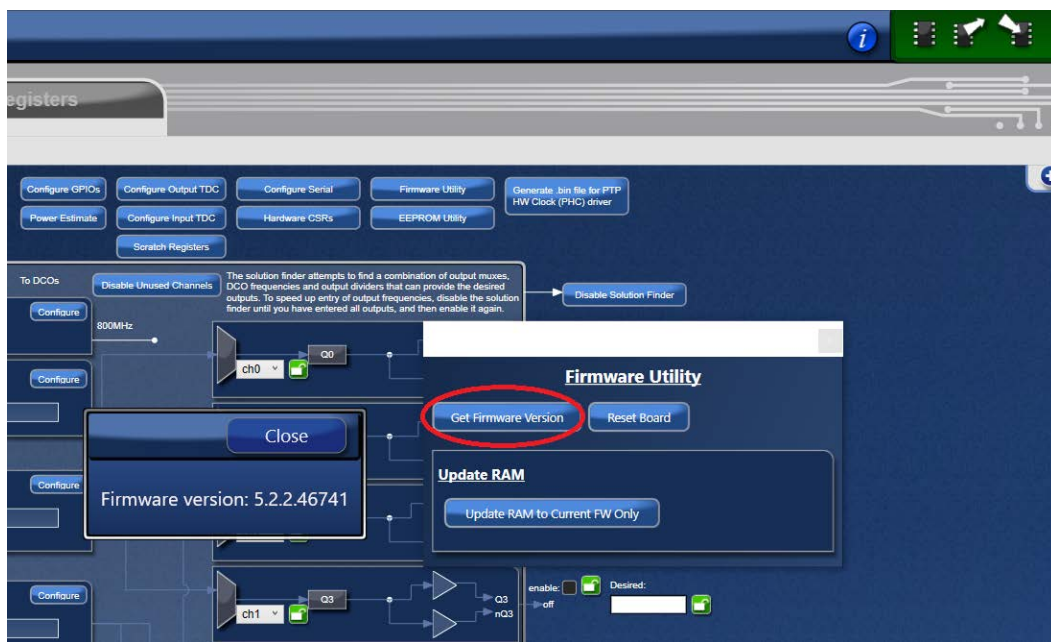

Figure 15. Read Firmware Version of ClockMatrix Chip

10. In a case where the firmware version mismatches each other, a firmware upgrade is necessary to bring the chip’s firmware updated. Please follow the Firmware Version Update steps below to bring the firmware up to date.

### 3.5 EEPROM Operations using the GUI

#### 3.5.1. Upload Firmware into the EEPROM

1. Click on:
  - EEPROM Utility
  - Connect to EEPROM
  - Write Firmware to EEPROM

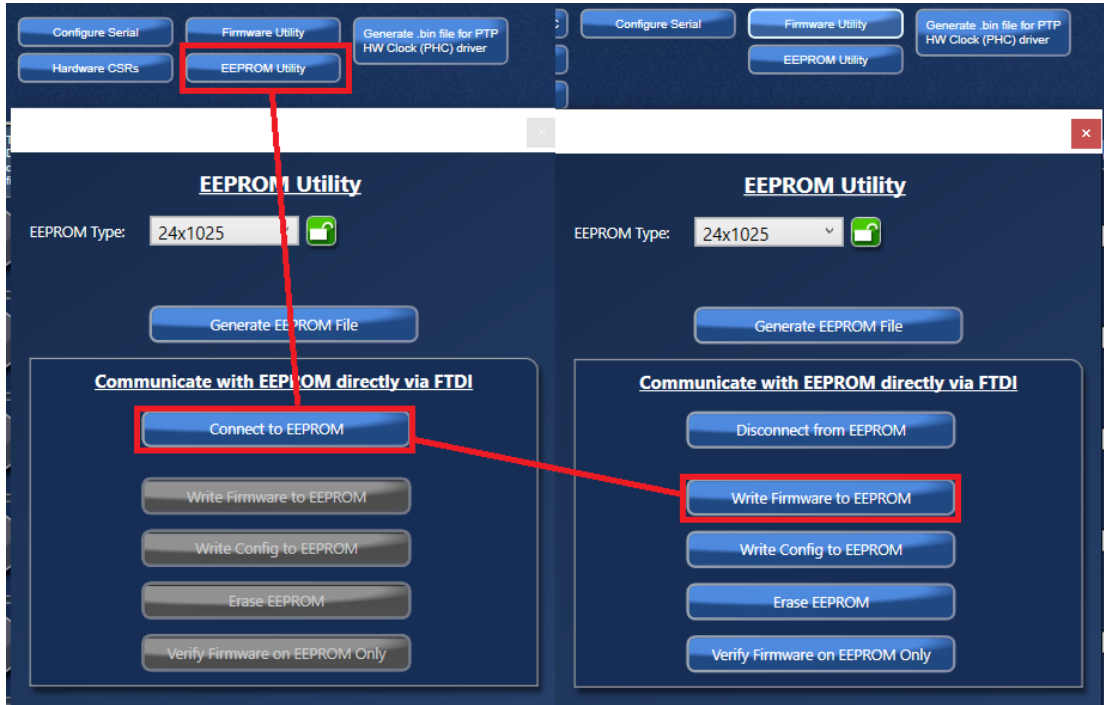

Figure 16. EEPROM Direct Writing using the GUI

2. In the next dialog, click on “Yes”.

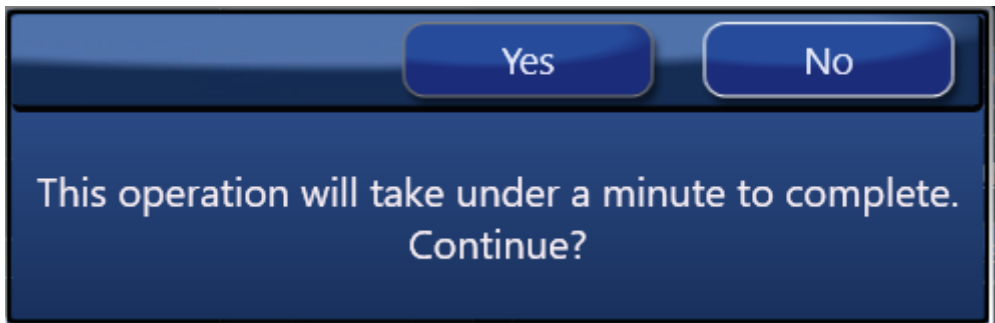

Figure 17. EEPROM Direct Writing Confirmation

- When asked to “Verify” the EEPROM, click on “No”:

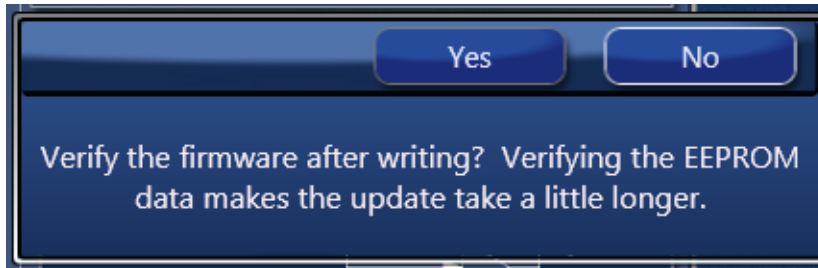

Figure 18. EEPROM Direct Verification using the GUI

- In the next window, press “Close” to start the EEPROM write.

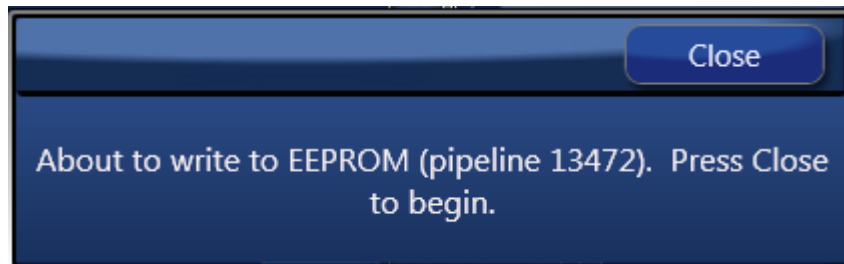

Figure 19. EEPROM Direct Additional Action

- Wait about 5 minutes. The EEPROM write will complete with this window below. Press “Close”.

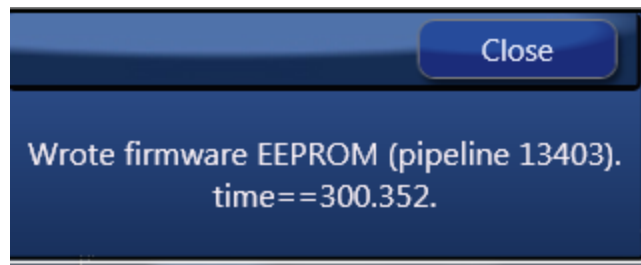

Figure 20. EEPROM Direct Confirmation of Write

### 3.5.2. Verify the EEPROM Programming

- Power cycle the Evaluation Board.
- Disconnect and reconnect to the chip.
- Read back the Firmware Version to ensure it is correct (see Figure 15).



## 4. Ordering Information

Part Number	Description
RC32614A-EVK	RC32614A Evaluation Board

## 5. Revision History

Revision	Date	Description
1.00	Dec 14, 2021	Initial release.