

#### PROTECTION PRODUCTS - RailClamp®

#### Description

RailClamp® TVS diodes are ultra low capacitance devices designed to protect sensitive electronics from damage or latch-up due to ESD, EFT, and EOS. They are designed for use on high speed ports in applications such as cell phones, notebook computers, and other portable electronics. These devices offer desirable characteristics for board level protection including fast response time, low operating and clamping voltage, and no device degradation.

RClamp®3331ZA features extremely good ESD protection characteristics including a low typical dynamic resistance of 0.20 Ohms, low peak ESD clamping voltage, and high ESD withstand voltage (+/-18kV contact per IEC 61000-4-2). Low typical capacitance (0.35pF at VR=0V) allows the RClamp3331ZA to be used in applications operating in excess of 5GHz without appreciable signal attenuation. Each device will protect one high speed data line operating at 3.3 Volts.

RClamp3331ZA is in a 2-pin SLP0603P2X3F package measuring 0.6 x 0.3 mm with a nominal height of 0.25mm. Leads are finished with lead-free NiAu. The small package gives the designer the flexibility to protect single lines in applications where arrays are not practical. The combination of low peak ESD clamping, low dynamic resistance, and low capacitance makes this device suitable for applications such as USB 3.0, MIPI and V-By-One interfaces in portable devices.

#### Features

- ◆ High ESD withstand Voltage: +/-**18kV** (Contact/Air) per **IEC 61000-4-2**
- ◆ Able to withstand over 1000 ESD strikes per IEC 61000-4-2 Level 4
- ◆ Ultra-small **0201 package**
- ◆ Protects one high speed data line
- ◆ Working voltage: +/- 3.3V
- ◆ Low capacitance: **0.35pF typical**
- ◆ Extremely low dynamic resistance: **0.20 Ohms (Typ)**
- ◆ Low ESD clamping voltage
- ◆ Solid-state silicon-avalanche technology

#### Mechanical Characteristics

- ◆ SLP0603P2X3F Package
- ◆ Pb-Free, Halogen Free, RoHS/WEEE Compliant
- ◆ Nominal Dimensions: 0.6 x 0.3 x 0.25 mm
- ◆ Lead Finish: NiAu
- ◆ Marking: Marking Code
- ◆ Packaging: Tape and Reel

#### Applications

- ◆ USB 2.0 / USB 3.0
- ◆ MIPI / MDDI
- ◆ V-By-One
- ◆ eDP
- ◆ MHL
- ◆ LVDS

#### Nominal Dimensions

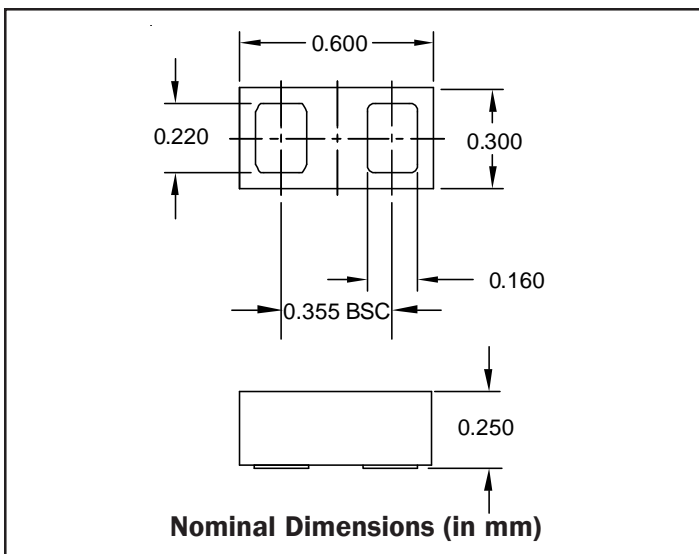

#### Schematic

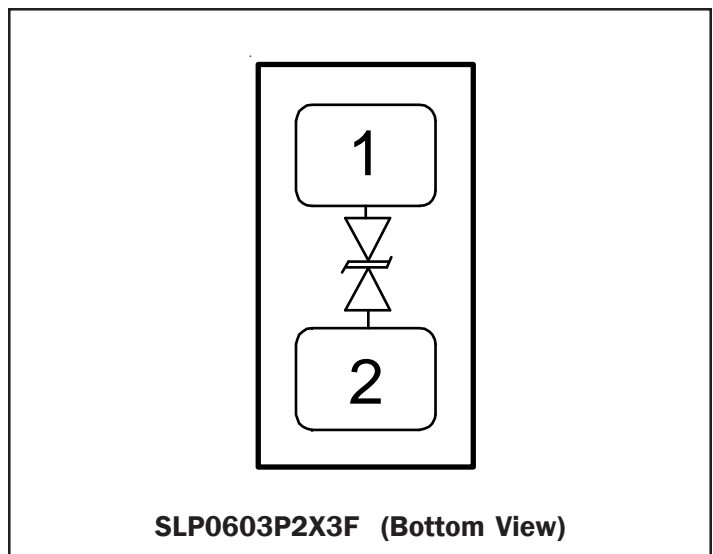

## PROTECTION PRODUCTS

### Absolute Maximum Rating

Rating	Symbol	Value	Units
Peak Pulse Power (tp = 8/20μs)	$P_{pk}$	30	Watts
Maximum Peak Pulse Current (tp = 8/20μs)	$I_{pp}$	4	Amps
ESD per IEC 61000-4-2 (Air) <sup>1</sup> ESD per IEC 61000-4-2 (Contact) <sup>1</sup>	$V_{ESD}$	+/- 18 +/- 18	kV
Operating Temperature	$T_J$	-40 to +85	°C
Storage Temperature	$T_{STG}$	-55 to +150	°C

### Electrical Characteristics (T=25°C)

Parameter	Symbol	Conditions	Minimum	Typical	Maximum	Units
Reverse Stand-Off Voltage	$V_{RWM}$	Pin 1 to 2 or 2 to 1			3.3	V
Breakdown Voltage	$V_{BR}$	$I_{BR} = 10\mu A$ Pin 1 to 2 or 2 to 1	5.5	8	10.5	V
Reverse Leakage Current	$I_R$	$V_{RWM} = 3.3V, T=25^\circ C$ Pin 1 to 2 or 2 to 1		<1	50	nA
Clamping Voltage	$V_C$	$I_{pp} = 1A, tp = 8/20\mu s$ Pin 1 to 2 or 2 to 1		3.8	5.5	V
Clamping Voltage	$V_C$	$I_{pp} = 4A, tp = 8/20\mu s$ Pin 1 to 2 or 2 to 1		5.5	7.5	V
ESD Clamping Voltage <sup>2</sup>	$V_C$	IPP = 4A, t <sub>lp</sub> = 0.2/100ns		4.5		V
ESD Clamping Voltage <sup>2</sup>	$V_C$	IPP = 16A, t <sub>lp</sub> = 0.2/100ns		7		V
Dynamic Resistance <sup>2,3</sup>	$R_D$	tp = 0.2/100ns		0.20		Ohms
Junction Capacitance	$C_J$	$V_R = 0V, f = 1MHz$		0.35	0.45	pF

#### Notes

1) ESD gun return path connected to ESD ground reference plane.

2) Transmission Line Pulse Test (TLP) Settings:  $t_p = 100ns, t_r = 0.2ns, I_{TLP}$  and  $V_{TLP}$  averaging window:  $t_1 = 70ns$  to  $t_2 = 90ns$ .

3) Dynamic resistance calculated from  $I_{TLP} = 4A$  to  $I_{TLP} = 16A$

## PROTECTION PRODUCTS

### Typical Characteristics

**Non-Repetitive Peak Pulse Power vs. Pulse Time**

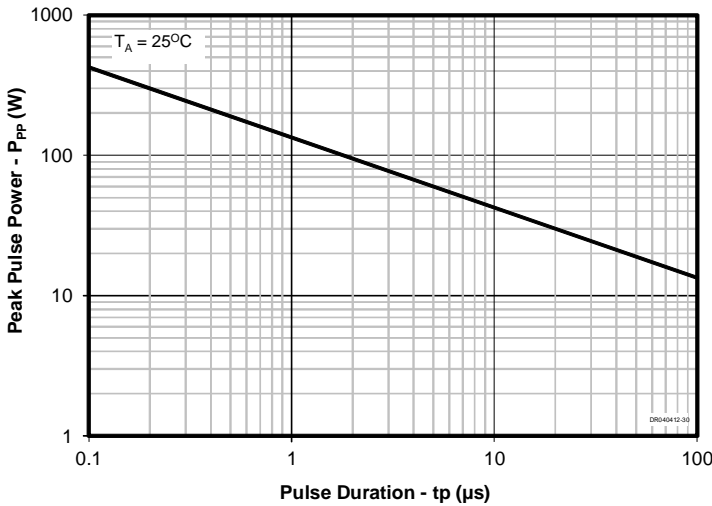

**Clamping Waveform (t<sub>p</sub>=1.2/50us)**

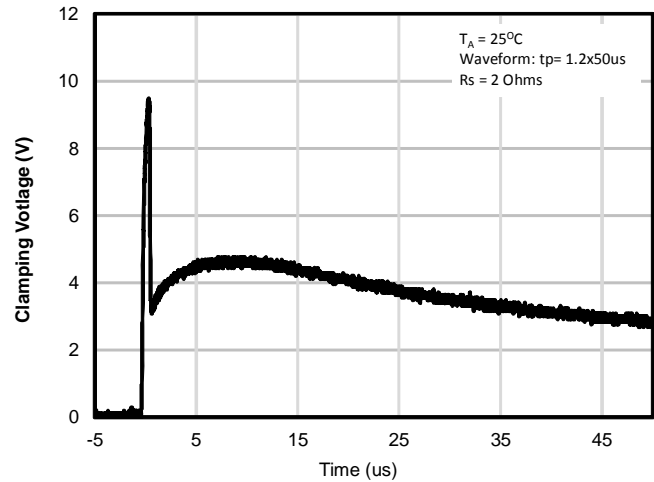

**TLP Characteristic (Positive)**

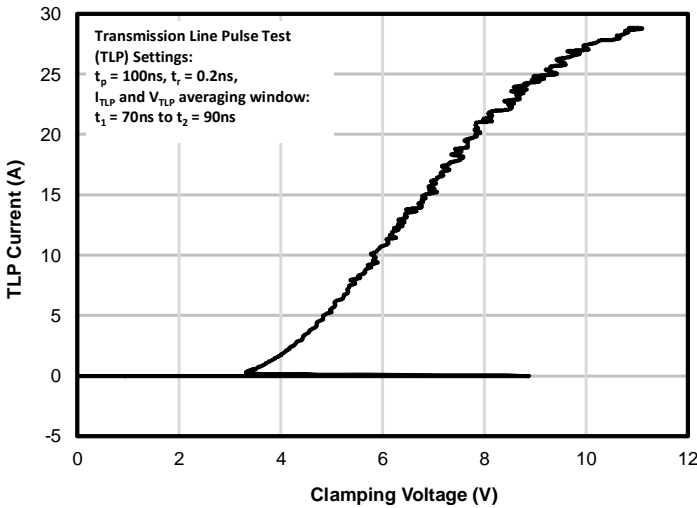

**TLP Characteristic (Negative)**

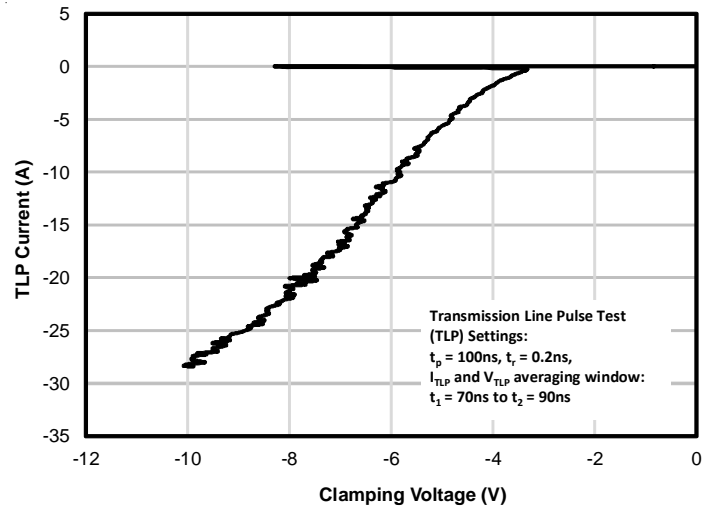

**ESD Clamping (+8kV Contact per IEC 61000-4-2)**

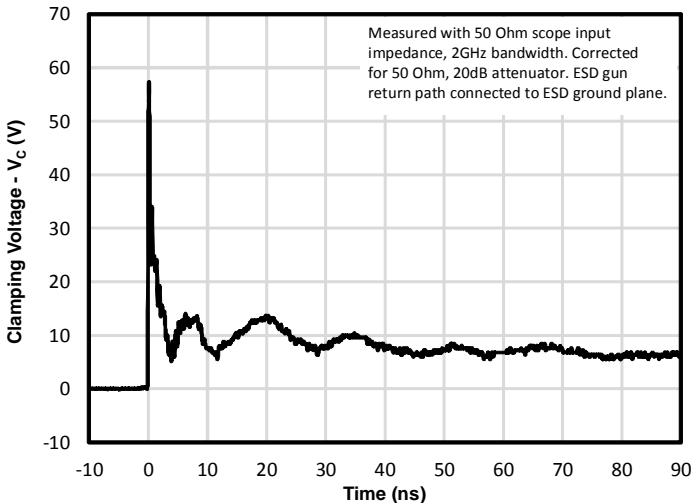

**ESD Clamping (-8kV Contact per IEC 61000-4-2)**

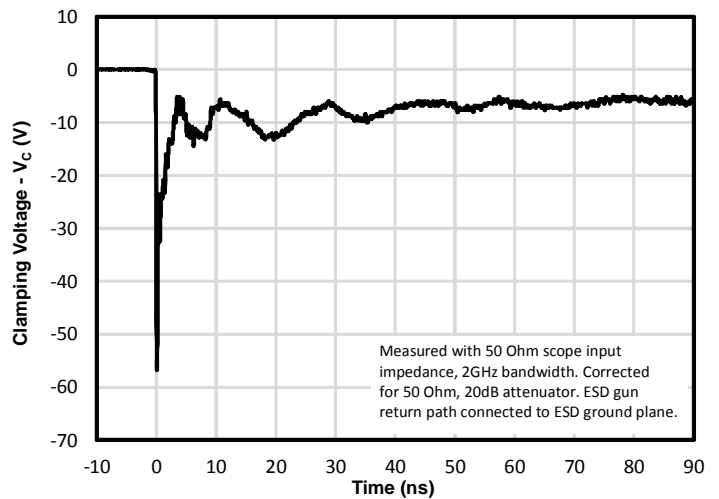

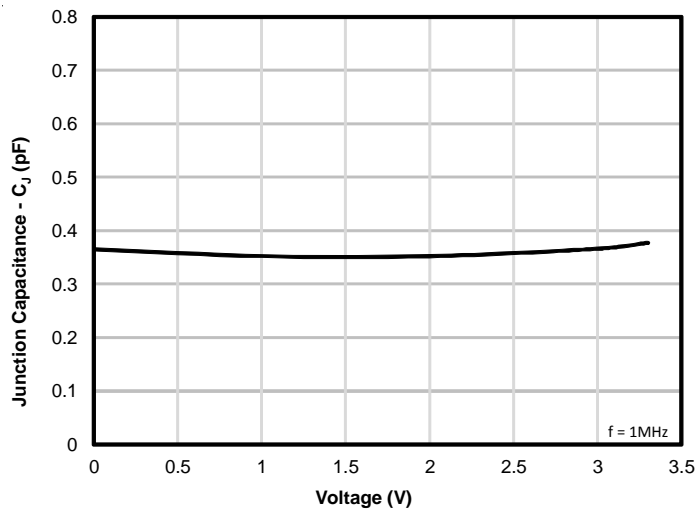
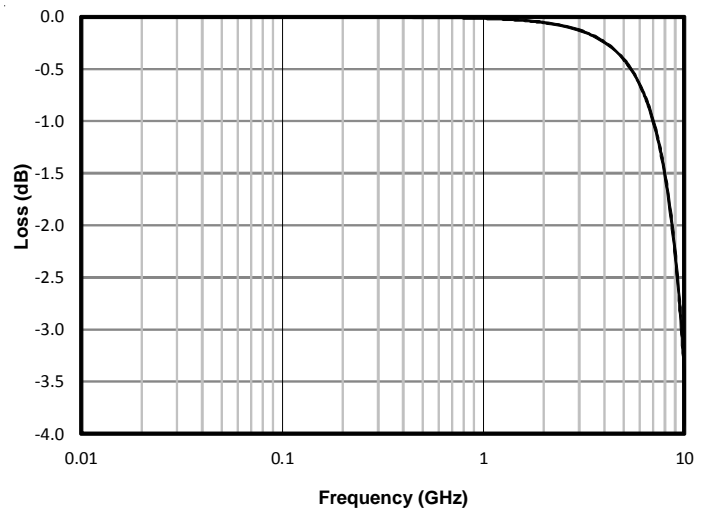
**PROTECTION PRODUCTS**
**Typical Characteristics**
**Junction Capacitance vs. Reverse Voltage**

**Typical Insertion Loss S21**

## PROTECTION PRODUCTS

### Applications Information

#### Assembly Guidelines

The small size of this device means that some care must be taken during the mounting process to insure reliable solder joints. The figure at the right details Semtech's recommended aperture based on the assembly guidelines detailed in the table below. Note that these are only recommendations and should serve only as a starting point for design since there are many factors that affect the assembly process. Exact manufacturing parameters will require some experimentation to get the desired solder application.

Assembly Parameter	Recommendation
Solder Stencil Design	Laser cut, Electro-polished
Aperture shape	Rectangular with rounded corners
Solder Stencil Thickness	0.100 mm (0.004")
Solder Paste Type	Type 4 size sphere or smaller
Solder Reflow Profile	Per JEDEC J-STD-020
PCB Solder Pad Design	Non-Solder mask defined
PCB Pad Finish	OSP OR NiAu

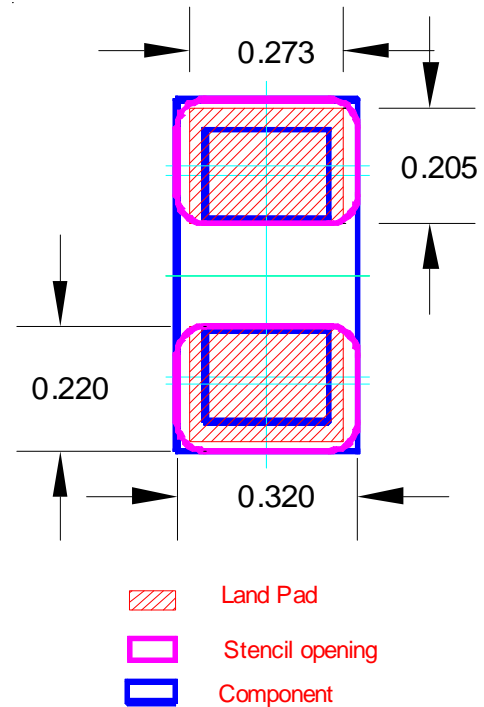

**Recommended Mounting Pattern**

## PROTECTION PRODUCTS

### Outline Drawing - SLP0603P2X3F

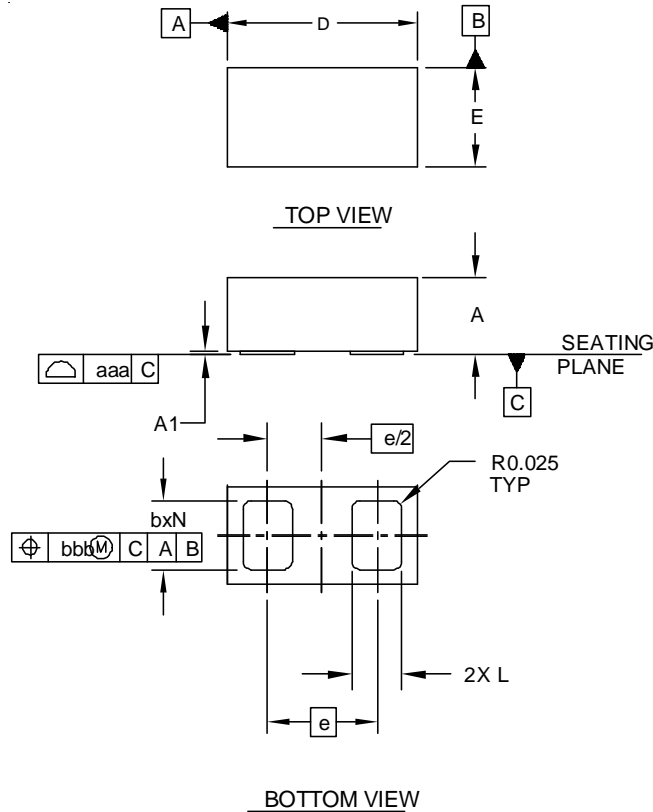

DIMENSIONS			
MILLIMETERS			
DIM	MIN	NOM	MAX
A	0.235	0.250	0.265
A1	0.000	0.010	0.050
b	0.200	0.220	0.240
D	0.580	0.600	0.620
E	0.280	0.300	0.320
e	0.355 BSC		
L	0.140	0.160	0.180
N	2		
aaa	0.08		
bbb	0.10		

- NOTES:
1. CONTROLLING DIMENSIONS ARE IN MILLIMETERS(ANGLES IN DEGREES).

### Land Pattern - SLP0603P2X3F

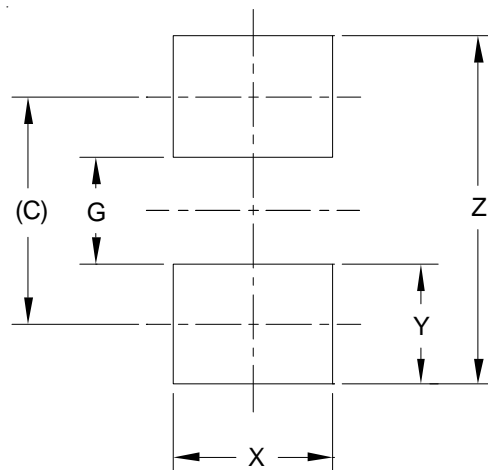

DIMENSIONS	
DIM	MILLIMETERS
C	(0.385)
G	0.181
X	0.273
Y	0.205
Z	0.590

- NOTES:
1. CONTROLLING DIMENSIONS ARE IN MILLIMETERS ( ANGLES IN DEGREES ).
  2. THIS LAND PATTERN IS FOR REFERENCE PURPOSES ONLY .  
CONSULT YOUR MANUFACTURING GROUP TO ENSURE YOUR  
COMPANY'S MANUFACTURING GUIDELINES ARE MET .

## PROTECTION PRODUCTS

### Marking Code

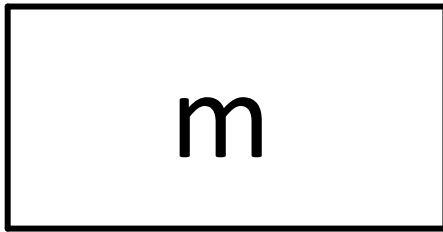

### Ordering Information

Part Number	Qty per Reel	Pocket Pitch	Reel Size
RClamp3331ZATFT	15,000	2mm	7 Inch

Notes:

RailClamp and RClamp are trademarks of Semtech Corporation

Note:  
Device is electrically symmetrical

### Carrier Tape Specification

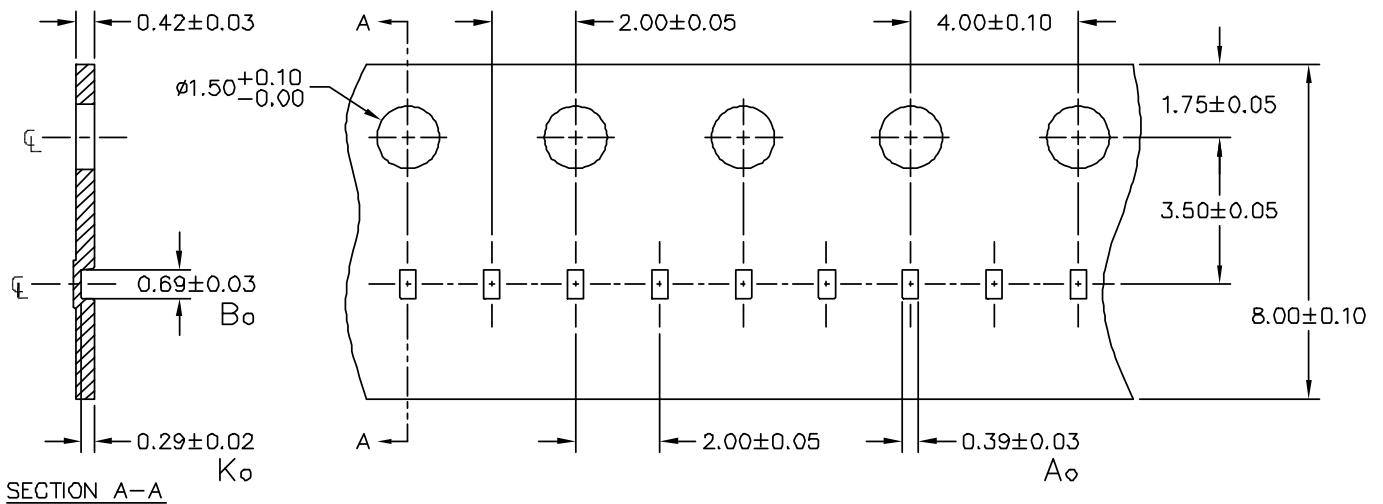

NOTES: ALL DIMENSIONS IN MILLIMETERS UNLESS OTHERWISE SPECIFIED.

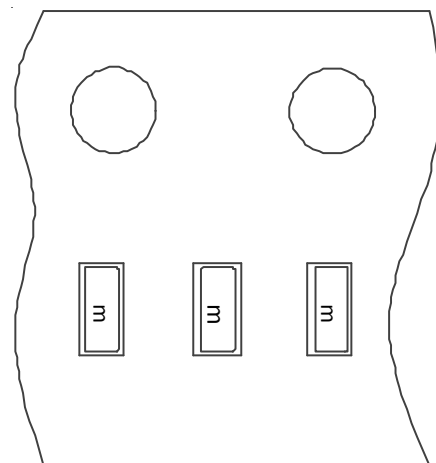

Device Orientation in Tape