

Title	<i>Reference Design Report for a >92% Efficient 75 W Power Factor Corrected LED Driver Using LinkSwitch™-PH LNK420EG</i>
Specification	190 VAC – 300 VAC Input; 29 V – 36 V, 2.1 A Output
Application	LED Driver for Industrial High Bay Light
Author	Applications Engineering Department
Document Number	RDR-290
Date	October 12, 2012
Revision	1.2

Summary and Features

- Single-stage combined power factor correction and accurate constant current (CC) output
- Low cost, low component count and small PCB footprint
- Highly energy efficient, >92 % at 230 VAC input; 36 V LED
- Fast start-up time (<300 ms) – no perceptible delay
- Integrated protection features
 - Single shot no-load latching protection / output short-circuit protected with auto-recovery
 - Auto-recovering thermal shutdown with large hysteresis protects both components and printed circuit board
 - No damage during brown-out conditions
 - PF >0.95 at 230 VAC
 - Meet Class C Harmonics Limits EN61000-3-2
 - Meet EN55015 conducted EMI
 - %A THD <20% at 230 VAC
- Meets IEC ring wave (2.5 kV), differential line surge (2 kV), common mode line surge (4 kV) and EN55015 conducted EMI

PATENT INFORMATION

The products and applications illustrated herein (including transformer construction and circuits external to the products) may be covered by one or more U.S. and foreign patents, or potentially by pending U.S. and foreign patent applications assigned to Power Integrations. A complete list of Power Integrations' patents may be found at www.powerint.com. Power Integrations grants its customers a license under certain patent rights as set forth at <http://www.powerint.com/ip.htm>.

Table of Contents

1	Introduction.....	4
2	Power Supply Specification	6
3	Schematic.....	7
4	Circuit Description	8
4.1	Input EMI Filtering	8
4.2	Flyback Using LinkSwitch-PH.....	8
4.3	Output Rectification	9
4.4	Protection	9
5	PCB Layout	10
6	Bill of Materials	11
6.1	Electrical Bill of Materials.....	11
6.2	Mechanical Bill of Materials	12
7	Transformer Specification.....	13
7.1	Electrical Diagram	13
7.2	Electrical Specifications.....	13
7.3	Materials.....	13
7.4	Transformer Build Diagram	14
7.5	Transformer Construction.....	14
7.6	Transformer Core Wrapping Process	15
8	Transformer Design Spreadsheet.....	18
9	Heat Sink Assemblies.....	21
9.1	Diode Heat Sink	21
9.1.1	Diode Heat Sink Drawing	21
9.1.2	Diode Heat Sink Fabrication Drawing.....	22
9.1.3	Diode and Heat Sink Assembly Drawing.....	23
9.2	eSIP Heat Sink	24
9.2.1	eSIP Heat Sink Drawing.....	24
9.2.2	eSIP Heat Sink Fabrication Drawing	25
9.2.3	eSIP and Heat Sink Assembly Drawing	26
10	Performance Data	27
10.1	Active Mode Efficiency	27
10.2	Line Regulation	28
10.3	Power Factor	29
10.4	%THD.....	30
10.5	Harmonic Currents	31
11	Thermal Performance	33
11.1	Equipment Used.....	33
11.2	Thermal Result	33
11.3	Thermal Scan	34
12	Waveforms.....	36
12.1	Drain Voltage and Current, Normal Operation.....	36
12.2	Drain Voltage and Current, Start-up Operation	36
12.3	Drain Voltage and Current, Output Short	37
12.4	Output Voltage and Output Current Start-up Profile	37



- 12.5 Output Current at Normal Operation38
- 12.6 Line Transient Response38
- 12.7 Start-up No-load and Normal Operation then No-load39
- 12.8 Secondary Diode Voltage Stress39
- 12.9 Line Surge Waveform40
- 13 Line Surge41
- 14 Conducted EMI42
 - 14.1 Equipment42
 - 14.2 EMI Test Set-up42
- 15 Revision History49

Important Note:

Although this board is designed to satisfy safety requirements for non-isolated LED driver, the engineering prototype has not been agency approved. Therefore, all testing should be performed using an isolation transformer to provide the AC input to the prototype board.



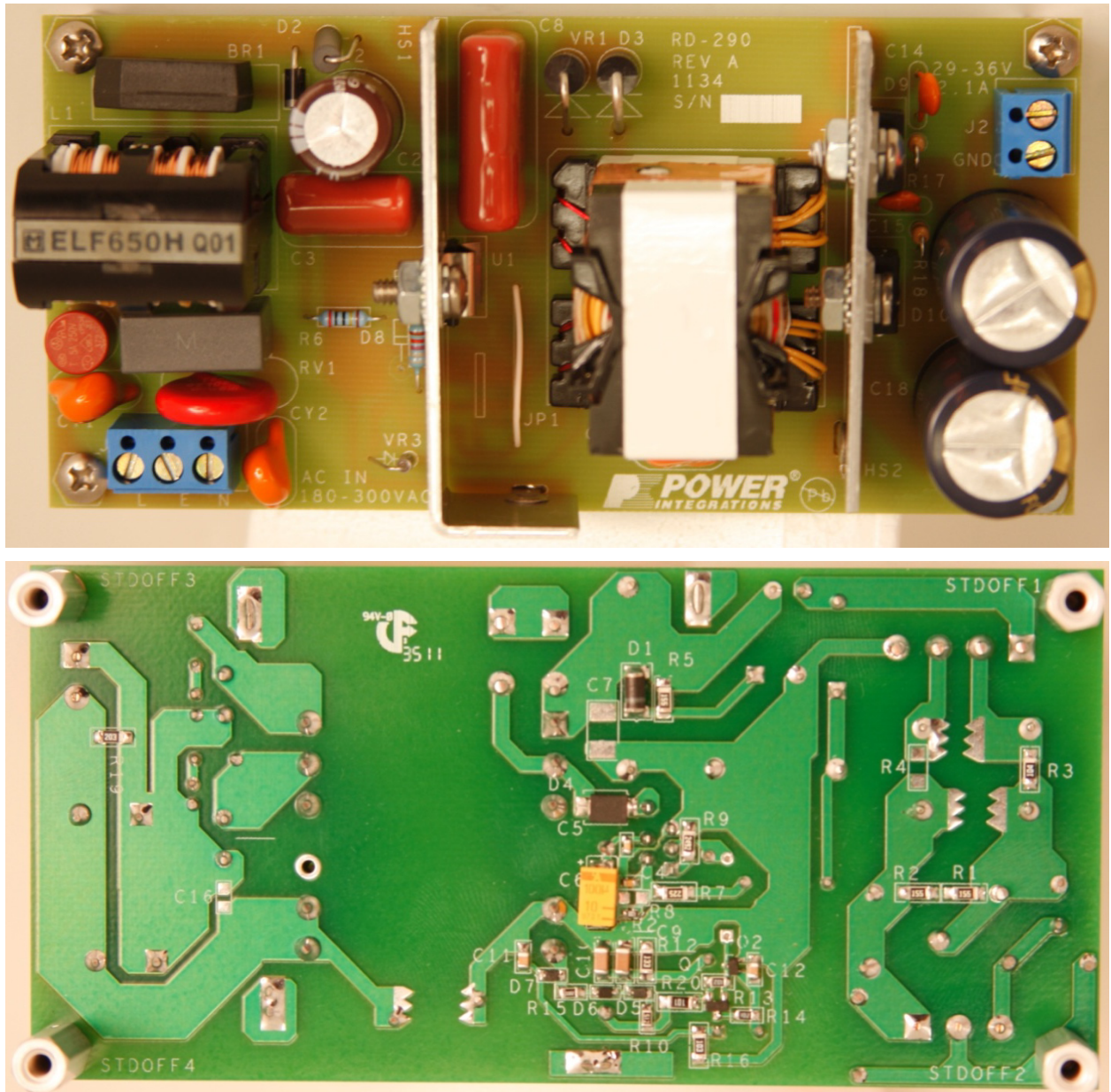

Figure 1 – Populated Circuit Board Photograph.



2 Power Supply Specification

The table below represents the minimum acceptable performance of the design. Actual performance is listed in the results section.

Description	Symbol	Min	Typ	Max	Units	Comment
Input						
Voltage	V_{IN}	190		300	VAC	2 Wire – no P.E.
Frequency	f_{LINE}	47	50/60	63	Hz	
Power Factor %ATHD		0.95		20		At any line input voltage EN61000-3-2(c)
Output						
Output Voltage	V_{OUT}	29	32	36	V	
Output Current	I_{OUT}	1.95	2.1	2.25	A	
Total Output Power						
Continuous Output Power	P_{OUT}		75		W	
Efficiency						
Nominal	η		92		%	Measured at 32 V, 2.1 A, 25 °C, 230 VAC
Environmental						
Conducted EMI		Meets CISPR22B / EN55015				
Line Surge Differential Mode (L1-L2)			2		kV	1.2/50 μ s surge, IEC 1000-4-5, Series Impedance: Differential Mode: 2 Ω
Common Mode (L1-PE,L2-PE)			4		kV	Differential Mode: 12 Ω
Ring Wave (100 kHz) Differential Mode (L1-L2)			2.5		kV	2 Ω short-circuit Series Impedance
Harmonic Currents		Meets EN61000-3-2 Class C				
Internal Ambient Temperature	T_{AMB}	0		70	°C	Board level, free convection, sea level



3 Schematic

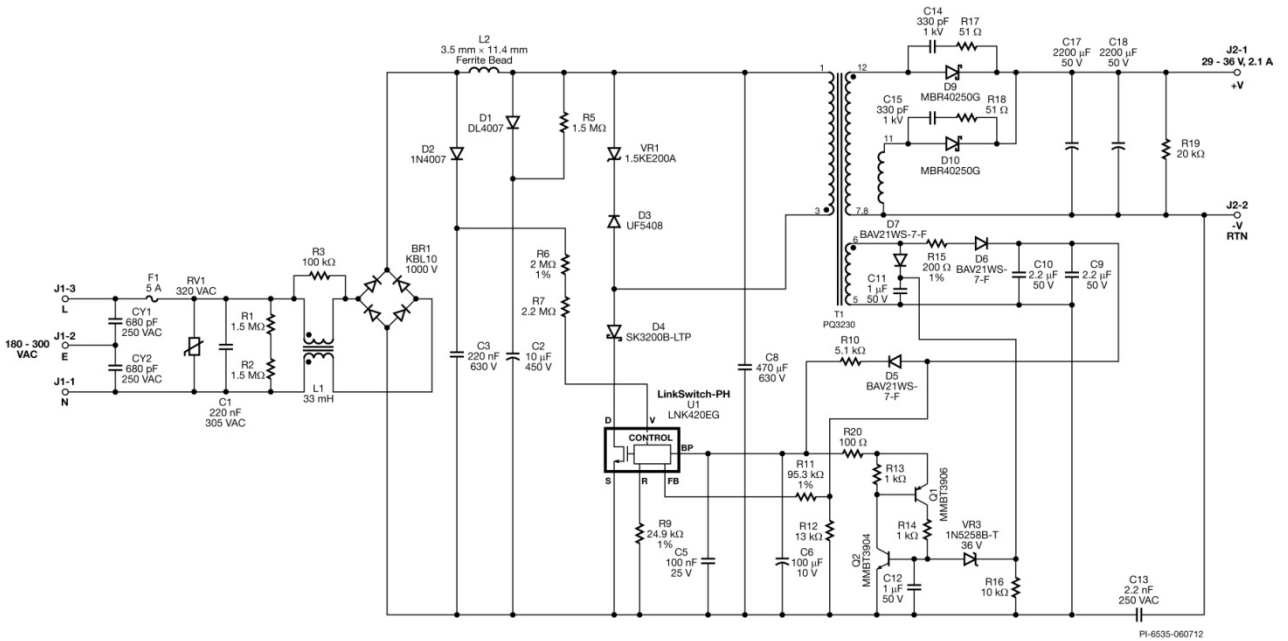

Figure 2 – Schematic.



4 Circuit Description

The LinkSwitch-PH (U1) is a highly integrated primary side controller intended for use in isolated LED driver applications. The LinkSwitch-PH provides high efficiency, high power factor and low THD in a single-stage conversion topology while regulating the output current over a wide range of input (180 VAC – 300 VAC) and output voltage variations typically found in LED driver application environments. All of the control circuitry necessary for these functions plus the high-voltage power MOSFET is incorporated into the device.

4.1 Input EMI Filtering

The AC supply to the LED driver is protected by fuse. The system input voltage is limited by RV1, D1, R5 and C2 during differential mode line surge voltage events.

The AC input is rectified by BR1. Minimal filter capacitance is used in order to achieve high power factor, low THD and low input current harmonics. Capacitor C8 provides a low impedance source for the primary switching currents.

Capacitor C1, common-mode choke L1, and differential choke L2, perform EMI filtering while maintaining high-power factor. This input filter network plus the frequency jittering feature of LinkSwitch-PH allows compliance to Class B emission limits. Resistor R3 is used to damp the resonance of the EMI filter, preventing peaks in the conducted EMI spectrum.

Capacitors CY1 and CY2 and C13 provide EMI filtering, reducing common mode conducted EMI currents.

4.2 Flyback Using LinkSwitch-PH

Diode D2 and C3 detect the peak AC line voltage. This voltage is converted to a current into the VOLTAGE MONITOR (V) pin via R6 and R7. This current is also used by the device to set the input over/under voltage protection thresholds and to provide a linear relationship between input voltage and the output current.

The V pin current and the FEEDBACK (FB) pin current are used internally to control the average output LED current. Constant current (CC) non-dimming applications require $24.9 \text{ k}\Omega \pm 1\%$ resistance (R9) on the REFERENCE (R) pin.

Diode D6, C9, C10, and R15, create the primary bias supply. This bias voltage is rectified and filter through D6 and C10 respectively. R15 filters the high frequency due to leakage which improves emi and regulation. The supply is used to supply current into the BYPASS (BP) pin through D5 and R10. Capacitors C6 and C5 serve as decoupling capacitors for the BP pin. Capacitor C6 is charged via an internal high-voltage current source connected to the DRAIN (D) pin of U1. This provides the energy to operate U1 until the bias voltage rises and supplies enough current can be provided via D5.



The output voltage is sensed via R11 which feeds a current in the FB pin proportional to the bias voltage. The bias is related to the output voltage via the bias to output winding turns ratio.

Diode D3 and VR1 clamp due to leakage inductance generated voltage spikes on the drain to a safe level. Diode D4 is necessary to prevent reverse current from flowing through the LinkSwitch-PH device.

- D4 is low drop diode (Schottky) selected to achieve good efficiency.
- T1 core size, winding construction and wire gauge are optimized to minimize inter-winding capacitance and low AC loss to achieve good efficiency.

4.3 Output Rectification

Diodes D9 and D10 rectify the secondary winding while capacitors C17 and C18 filter the output. The anode of rectifier diodes are connected to dedicated transformer output windings to assure current sharing. Dedicated RC clamping circuits are placed across each output diode to reduce voltage stress and to limit ringing, reducing radiated and conducted noise.

- Diodes D9 and D10 are low drop diodes (Schottky), selected to improve efficiency.

4.4 Protection

The system is protected by a latching over-voltage circuit (D7, C11, C12, VR3, Q1, Q2, R13, R14, R16 and R20). A separate bias voltage was used (via D7 and C11) to reduce the time for the OVP to trigger. Resistor R20 prevents the BP pin being pulled to below ~2 V which limits the dissipation of U1 when the latch is triggered. The OVP circuit operates if the load is not connected and prevents catastrophic failure of the output capacitor. The latch can only be reset by recycling the AC input.

The device is thermally protected in case the system is operated above the specified temperature range.



5 PCB Layout

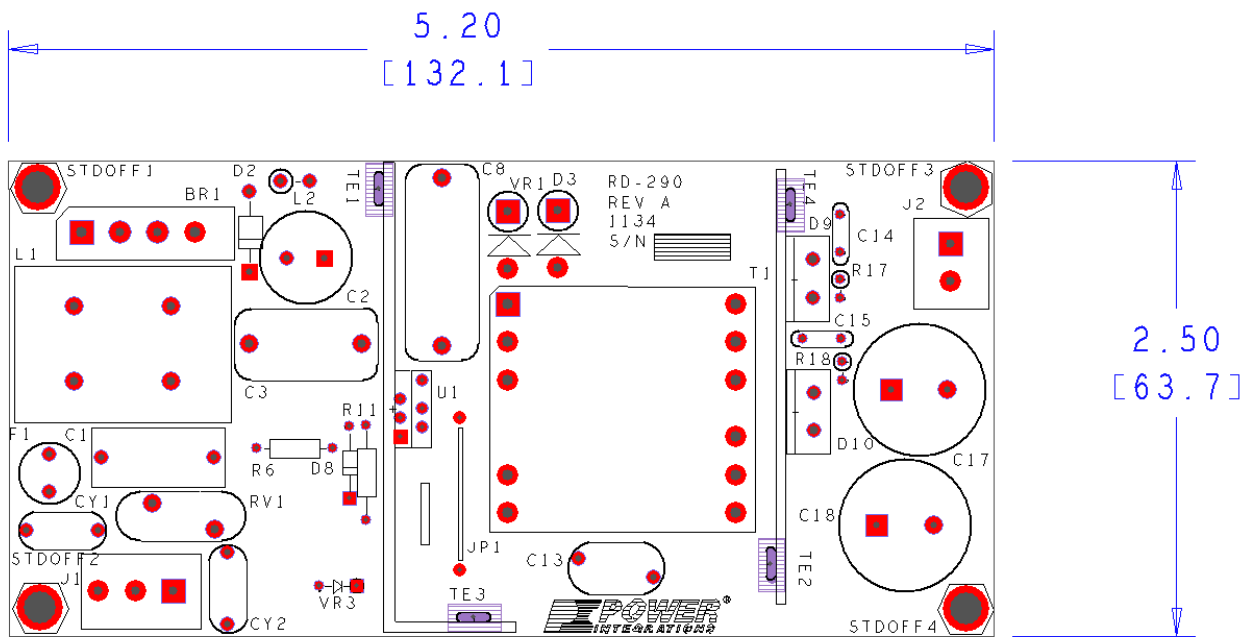

Figure 3 – Top Printed Circuit Layout.

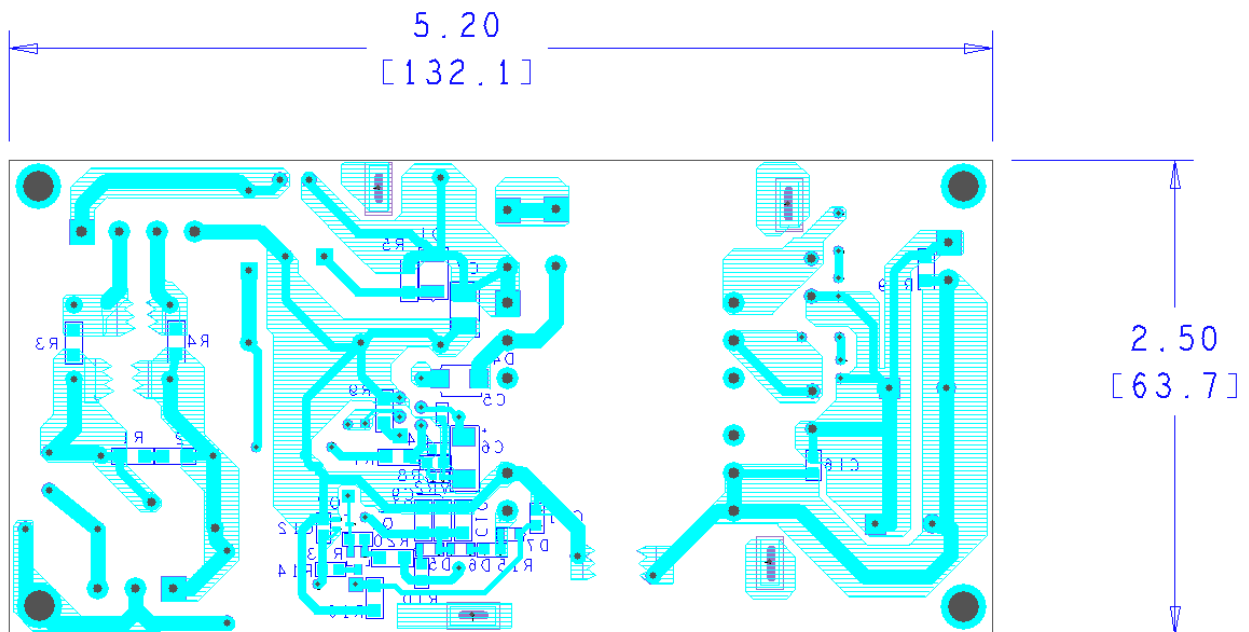

Figure 4 – Bottom Printed Circuit Layout.



6 Bill of Materials

The table below is divided into two sections: electrical and mechanical.

6.1 Electrical Bill of Materials

Item	Qty	Ref Des	Description	Manufacturer P/N	Manufacturer
1	1	BR1	1000 V, 4 A, Bridge Rectifier	KBL10-E4/51	Vishay
2	1	C1	220 nF, 305 VAC, Film, X2	R463I322000M2M	Kemet
3	1	C2	10 μ F, 450 V, Electrolytic, (12.5 x 20)	EKMG451ELL100MK20S	United Chemi-Com
4	1	C3	220 nF, 630 V, Film	ECQ-E6224KF	Panasonic
5	1	C5	100 nF 25 V, Ceramic, X7R, 0603	ECJ-1VB1E104K	Panasonic
6	1	C6	100 μ F, 10 V, Tant Electrolytic, C Case, SMD	T491C107K010AS	Kemet
7	1	C8	470 nF, 630 V, Film	ECQ-E6474KF	Panasonic
8	2	C9 C10	2.2 μ F, 50 V, Ceramic, Y5V, 1206	GRM31MF51H225ZA01L	Murata
9	2	C11 C12	1 μ F, 50 V, Ceramic, X7R, 0805	08055D105KAT2A	AVX
10	1	C13	2.2 nF, Ceramic, Y1	440LD22-R	Vishay
11	2	C14 C15	330 pF, 1 kV, Disc Ceramic	562R5GAT33	Vishay
12	2	C17 C18	2200 μ F, 50 V, Electrolytic, Gen. Purpose, (18 x 35.5)	EKMG500ELL222MLP1S	Nippon Chemi-Con
13	2	CY1 CY2	680 pF, Ceramic, Y1	440LT68-R	Vishay
14	1	D1	1000 V, 1 A, Rectifier, Glass Passivated, DO-213AA (MELF)	DL4007-13-F	Diodes, Inc.
15	1	D2	1000 V, 1 A, Rectifier, DO-41	1N4007-E3/54	Vishay
16	1	D3	1000 V, 3 A, Ultrafast Recovery, 50 ns, DO-201AD	UF5407-E3/54	Vishay
17	1	D4	200 V, 3 A, DIODE SCHOTTKY 1A 200V, SMB	SK3200B-LTP	Micro Commercial
18	3	D5 D6 D7	250 V, 0.2 A, Fast Switching, 50 ns, SOD-323	BAV21WS-7-F	Diodes, Inc.
19	2	D9 D10	250 V, 40 A, Schottky, TO-220AC	MBR40250G	On Semi
20	1	F1	5 A, 250 V, Slow, TR5	37215000411	Wickman
21	1	J1	CONN TERM BLOCK 5.08 MM 3POS	ED120/3DS	On Shore Technology
22	1	J2	CONN TERM BLOCK 5.08 MM 2POS	ED120/2DS	On Shore Technology
23	1	L1	33 mH, 0.8 A, Common Mode Choke	ELF-18D650H	Panasonic
24	1	L2	3.5 mm x 11.4 mm, 144 Ω at 100 MHz, #22 AWG hole, Ferrite Bead	2761008112	Fair-Rite
25	1	Q1	PNP, Small Signal BJT, 40 V, 0.2 A, SOT-23	MMBT3906LT1G	On Semi
26	1	Q2	NPN, Small Signal BJT, 40 V, 0.2 A, SOT-323	MMST3904-7-F	Diodes, Inc.
27	3	R1 R2 R5	1.5 M Ω , 5%, 1/4 W, Thick Film, 1206	ERJ-8GEYJ155V	Panasonic
28	1	R3	100 k Ω , 5%, 1/4 W, Thick Film, 1206	ERJ-8GEYJ104V	Panasonic
29	1	R6	2.00 M Ω , 1%, 1/4 W, Metal Film	RNF14FTD2M00	Stackpole
30	1	R7	2.2 M Ω , 5%, 1/4 W, Thick Film, 1206	ERJ-8GEYJ225V	Panasonic
31	1	R9	24.9 k Ω , 1%, 1/4 W, Thick Film, 1206	ERJ-8ENF2492V	Panasonic
32	1	R10	5.1 k Ω , 5%, 1/8 W, Thick Film, 0805	ERJ-6GEYJ512V	Panasonic
33	1	R11	95.3 k Ω , 1%, 1/4 W, Metal Film	MFR-25FBF-95K3	Yageo
34	1	R12	13 k Ω , 5%, 1/4 W, Thick Film, 1206	ERJ-8GEYJ133V	Panasonic
35	2	R13 R14	1 k Ω , 5%, 1/8 W, Thick Film, 0805	ERJ-6GEYJ102V	Panasonic
36	1	R15	200 Ω , 1%, 1/8 W, Thick Film, 0805	ERJ-6ENF2000V	Panasonic
37	1	R16	10 k Ω , 5%, 1/4 W, Thick Film, 1206	ERJ-8GEYJ103V	Panasonic
38	2	R17 R18	51 Ω , 5%, 1/4 W, Carbon Film	CFR-25JB-51R	Yageo
39	1	R19	20 k Ω , 5%, 1/4 W, Thick Film, 1206	ERJ-8GEYJ203V	Panasonic
40	1	R20	100 Ω , 5%, 1/4 W, Thick Film, 1206	ERJ-8GEYJ101V	Panasonic



41	1	RV1	320 V, 80 J, 14 mm, RADIAL	V320LA20AP	Littlefuse
42	1	T1	Custom Transformer, PQ3230, Vertical, 12 Pins, RD-290	Custom	Power Integrations
43	1	U1	LinkSwitch-PH, eSIP	LNK420EG	Power Integrations
44	1	VR1	200 V, 1500 W, TVS, GP-20	1.5KE200A-E3/54	Vishay
45	1	VR3	36 V, 5%, 500 mW, DO-35	1N5258B-T	Diodes, Inc.

6.2 Mechanical Bill of Materials

Item	Qty	Ref Des	Description	Manufacturer P/N	Manufacturer
46	1	ESIPCLIP M4 METAL1	Heat Sink Hardware, Edge Clip, 20.76 mm L x 8 mm W x 0.015 mm Thk	NP975864	Aavid Thermalloy
47	3	GREASE1 GREASE2 GREASE3	Thermal Grease, Silicone, 5 oz Tube	CT40-5	ITW Chemtronics
48	1	HS1	Heat Sink, RDK290-eSIP, FAB, eSIP with BRKTS, PI Custom	61-00070-01	Custom
49	1	HS2	Heat Sink, RDK290-Diode, FAB, Diode with BRKTS, PI Custom	61-00071-01	Custom
50	1	JP1	Wire Jumper, Insulated, 24 AWG, 0.8 in	C2003A-12-02	Gen Cable
51	3	NUT1 NUT2 NUT3	Nut, Hex, Kep 6-32, Zinc Plate	6CKNTZR	Any RoHS Compliant Mfg.
52	3	SCREW1 SCREW2 SCREW3	SCREW MACHINE PHIL 6-32 X 3/8 SS	PMSSS 632 0038 PH	Building Fasteners
53	3	WASHER1 WASHER2 WASHER3	Washer, Lk, #6 SS, Zinc Plate	620-6Z	Olander Co.



7 Transformer Specification

7.1 Electrical Diagram

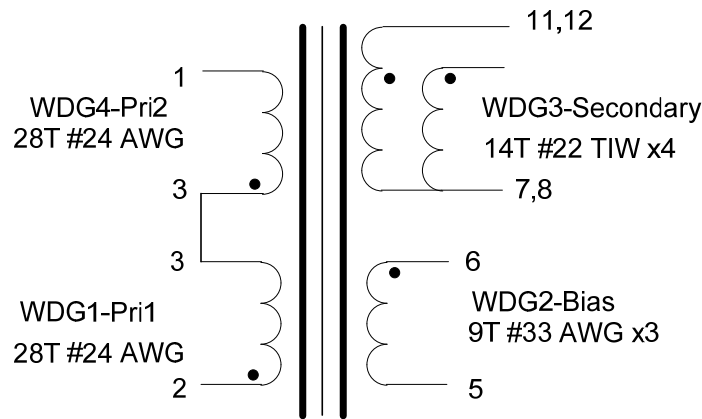

Figure 5 – Transformer Electrical Diagram.

7.2 Electrical Specifications

Electrical Strength	1 second, 60 Hz, from pins 1-6 to pins 7-12	3000 VAC
Primary Inductance	Pins 1-2, all other windings open, measured at 100 kHz, 0.4 V _{RMS}	1207 μH, ±10%
Resonant Frequency	Pins 1-2, all other windings open	1400 kHz (Min.)
Primary Leakage Inductance	Pins 1-2, with pins 6-7 shorted, measured at 100 kHz, 0.4 V _{RMS}	15.0 μH (Max.)

7.3 Materials

Item	Description
[1]	Core: PC44; PQ3230
[2]	Bobbin: RPQ3230 Vertical, 6/6 Pins
[3]	Magnet Wire: #24 AWG
[4]	Magnet Wire: #33 AWG
[5]	Magnet Wire: #22 AWG Triple-insulated Wire
[6]	Tape: 3M 1298 Polyester Film, 17.7 mm width
[7]	Tape: 3M 1298 Polyester Film, 36 mm width
[8]	Tape: 3M 1298 Polyester Film, 10 mm width
[9]	Copper Tape: 12 mm
[10]	Varnish



7.4 Transformer Build Diagram

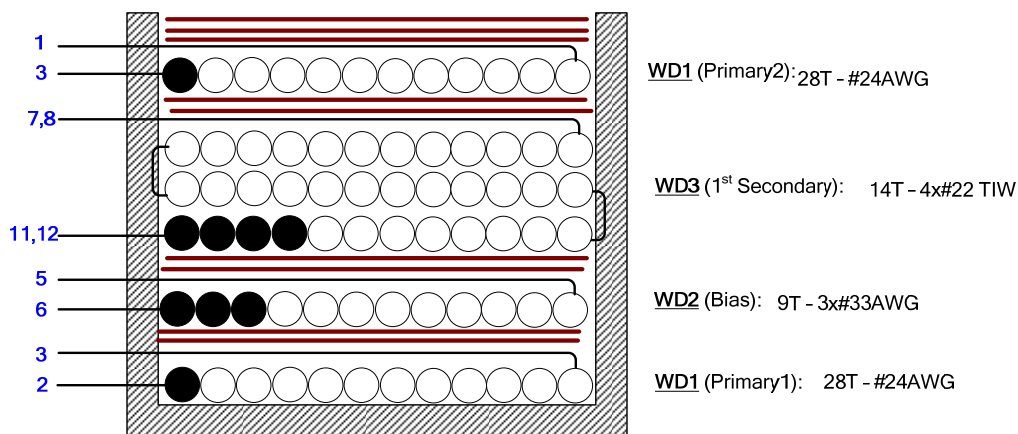

Figure 6 – Transformer Build Diagram.

7.5 Transformer Construction

Bobbin Preparation	Pull-out pin number 4. Position the bobbin such that the pins are on the left side of the bobbin chuck. Machine rotates in forward direction.
WDG1 Primary 1	Start at pin 2; wind with firm tension 28 turns of item [3] from left to right. Finish at pin 3.
Insulation	2 layers of tape [6] for insulation.
WDG2 Bias	Start at pin 6; wind with firm tension 9 trifilar turns of item [4] from left to right. Finish at pin 5.
Insulation	2 layers of tape [6] for insulation.
WDG3 Secondary	Start in 2 wires per pin at pin 11 and 12; wind with firm tension 14 quadfilar turns of item [5] in continuously in three layers. Finish at pin 7 and 8. Termination is 2 wires per pin.
Insulation	2 layers of tape [6] for insulation.
WDG4 Primary 2	Start at pin 3; wind with firm tension 28 turns of item [3] from left to right. Finish at pin 1.
Insulation	3 layers of tape [6] for insulation.
Taping	Add 1 layer of tape [7] on the bottom side of the transformer to isolate the core to secondary and primary pins. Refer to figures below:
Assemble Core	Assemble and secure the cores with 3 layers of tape [8]
Copper Shield	Add 1 turn of copper shield around the core legs as shown in the illustration.
Finish	Varnish transformer assembly.

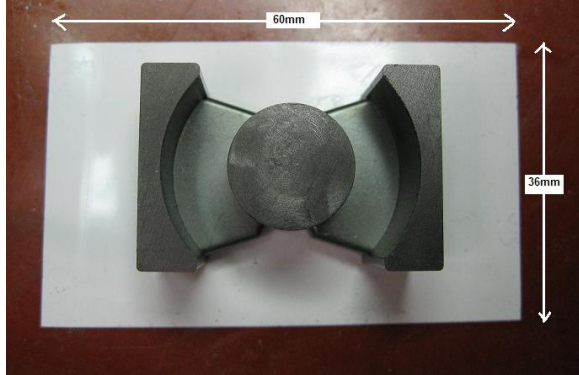
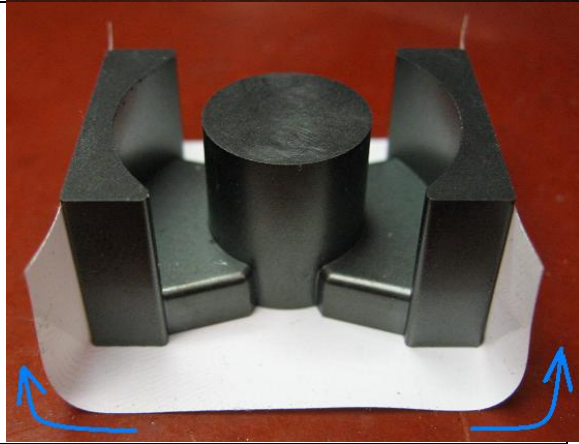
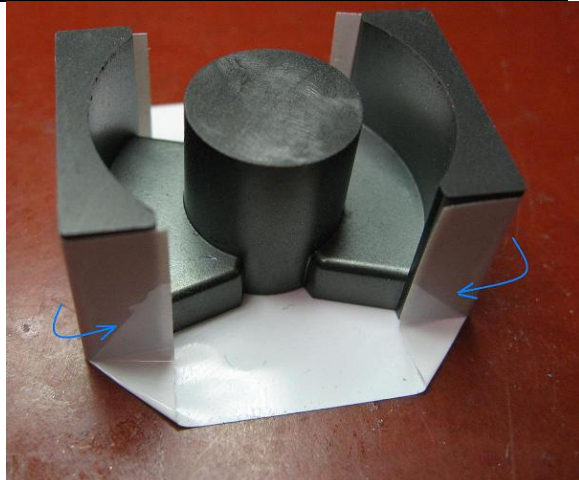

7.6 Transformer Core Wrapping Process

<p>Step 1. Position the core at the center of 60 mm x 36 mm polyester film tape [7]</p>	
<p>Step 2. Fold both ends of the tape into the sides of the core as shown in the illustration. Make sure that no excess tape higher than the core.</p>	
<p>Step 3. Fold the tape in the 4 corners of the core. Extend the folding down to the bottom of the tape until it locks.</p>	



Step 4. Cut the center of the bottom tape on its 2 sides.

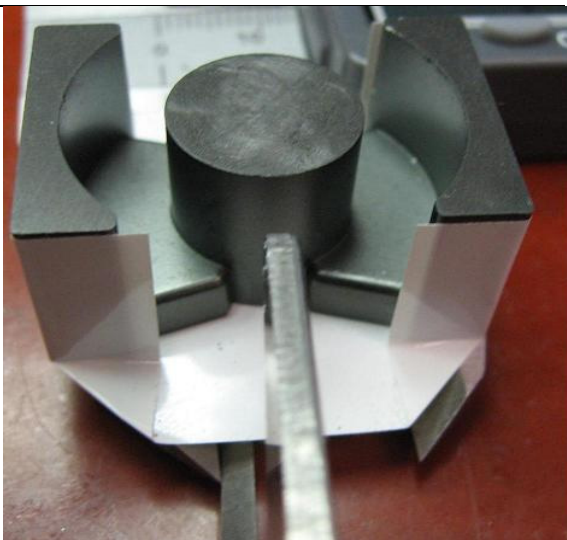

Step 5. Fold the tape into the legs of the core as shown in the illustration. Same procedure is applied to the other side of the core.

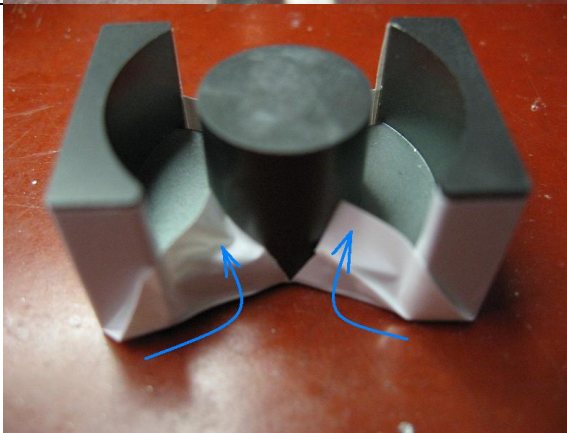

Step 6. Insert the wrapped core into the bottom side of the bobbin. Make sure that the tape is inserted between the core and the bobbin as shown in the figure.

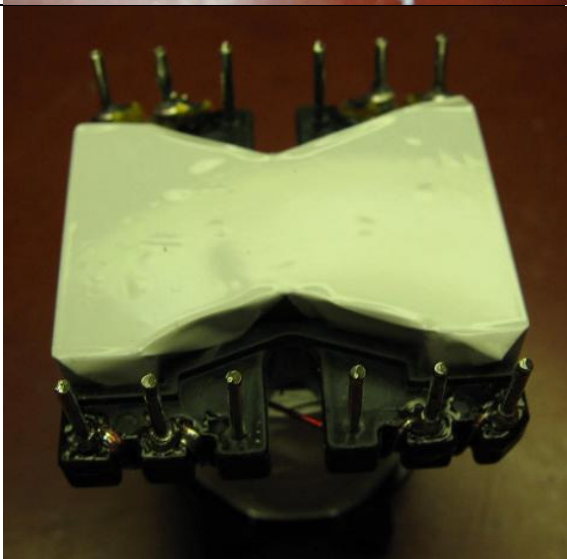

Step 7. Grind the top portion of the core to set the inductance as required. Assemble and fix the cores as shown in the illustration. Varnish.

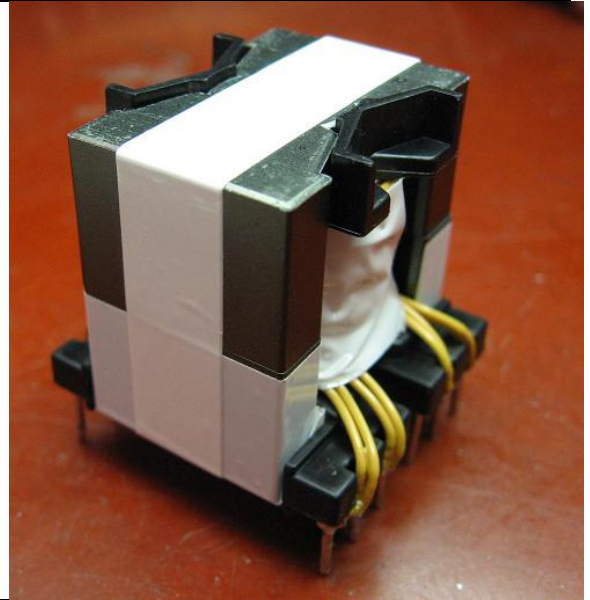

Step 8. Add 1 turn of copper shield as shown in the illustration. Solder the end of the copper shield. Varnish.

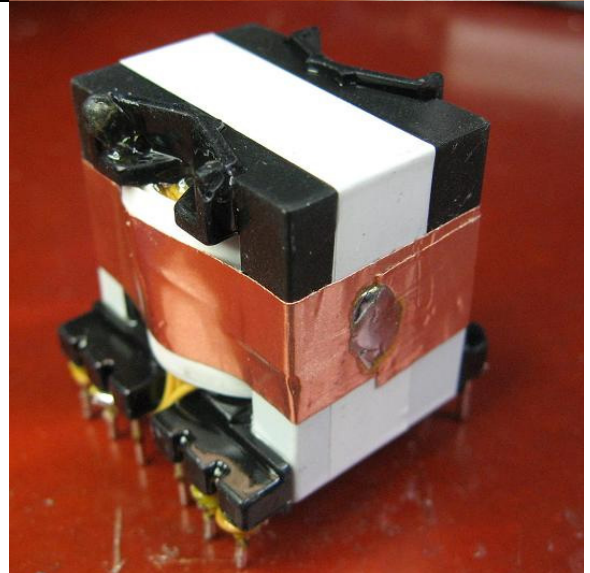

Figure 7 – Core Wrapping and Shielding Illustration.



8 Transformer Design Spreadsheet

ACDC_LinkSwitch-PH 032511; Rev.1.3; Copyright Power Integrations 2011	INPUT	INFO	OUTPUT	UNIT	LinkSwitch-PH_032511: Flyback Transformer Design Spreadsheet
ENTER APPLICATION VARIABLES					
Dimming required	NO		NO		Select 'YES' option if dimming is required. Otherwise select 'NO'.
VACMIN			190	V	Minimum AC Input Voltage
VACMAX			300	V	Maximum AC input voltage
fL			50	Hz	AC Mains Frequency
VO	36.00			V	Typical output voltage of LED string at full load
VO_MAX	36.00		36.00	V	Maximum expected LED string Voltage.
VO_MIN	29.00		29.00	V	Minimum expected LED string Voltage.
V_OVP			39.60	V	Over-voltage protection setpoint
IO	2.10			A	Typical full load LED current
PO			75.6	W	Output Power
n	0.92		0.92		Estimated efficiency of operation
VB			20	V	Bias Voltage
ENTER LinkSwitch-PH VARIABLES					
LinkSwitch-PH	LNK410			Universal	115 Doubled/230V
Chosen Device		LNK410	Power Out	85W	6.8W
Current Limit Mode	FULL		FULL		Select "RED" for reduced Current Limit mode or "FULL" for Full current limit mode
ILIMITMIN			5.30	A	Minimum current limit
ILIMITMAX			6.20	A	Maximum current limit
fS			66000	Hz	Switching Frequency
fSmin			62000	Hz	Minimum Switching Frequency
fSmax			70000	Hz	Maximum Switching Frequency
IV			78.4	uA	V pin current
RV	4.2		4	M-ohms	Upper V pin resistor
RV2			1.402	M-ohms	Lower V pin resistor
IFB	190		190	uA	FB pin current (85 uA < IFB < 210 uA)
RFB1			89.5	k-ohms	FB pin resistor
VDS			10	V	LinkSwitch-PH on-state Drain to Source Voltage
VD	0.50			V	Output Winding Diode Forward Voltage Drop (0.5 V for Schottky and 0.8 V for PN diode)
VDB	0.70			V	Bias Winding Diode Forward Voltage Drop
Key Design Parameters					
KP	0.56		056		Ripple to Peak Current Ratio (For PF > 0.9, 0.4 < KP < 0.9)
LP			1205	uH	Primary Inductance
VOR	130.00		130	V	Reflected Output Voltage.
Expected IO (average)			2.06	A	Expected Average Output current is outside 5% tolerance band. Change IFB to 206 for better current regulation set-point
KP_VACMAX			0.72		Expected ripple current ratio at VACMAX
TON_MIN			3.55	Us	Minimum on time at maximum AC input voltage
PCLAMP			0.67	W	Estimated dissipation in primary clamp
ENTER TRANSFORMER CORE/CONSTRUCTION VARIABLES					
Core Type	PQ3230		PQ3230		
Bobbin		PQ3230/ 12pins			
AE	1.6700		1.67	cm^2	Core Effective Cross Sectional Area
LE	7.5000		7.5	Cm	Core Effective Path Length
AL	4500.0		4500	nH/T^2	Ungapped Core Effective Inductance
BW	17.0		17	Mm	Bobbin Physical Winding Width
M			0	Mm	Safety Margin Width (Half the Primary to Secondary Creepage Distance)
L	2.00		2		Number of Primary Layers
NS	14		14		Number of Secondary Turns
DC INPUT VOLTAGE PARAMETERS					



VMIN			269	V	Peak input voltage at VACMIN
VMAX			424	V	Peak input voltage at VACMAX
CURRENT WAVEFORM SHAPE PARAMETERS					
DMAX			0.33		Minimum duty cycle at peak of VACMIN
Iavg			0.42	A	Average Primary Current
IP			2.21	A	Peak Primary Current (calculated at minimum input voltage VACMIN)
IRMS			0.73	A	Primary RMS Current (calculated at minimum input voltage VACMIN)
TRANSFORMER PRIMARY DESIGN PARAMETERS					
LP			1207	uH	Primary Inductance
NP			50		Primary Winding Number of Turns
NB			9		Bias Winding Number of Turns
ALG			385	nH/T^2	Gapped Core Effective Inductance
BM			2849	Gauss	Maximum Flux Density at PO, VMIN (BM<3100)
BP			3525	Gauss	Peak Flux Density (BP<3700)
BAC			798	Gauss	AC Flux Density for Core Loss Curves (0.5 X Peak to Peak)
ur			1608		Relative Permeability of Ungapped Core
LG			0.50	mm	Gap Length (Lg > 0.1 mm)
BWE			34	mm	Effective Bobbin Width
OD			0.61	mm	Maximum Primary Wire Diameter including insulation
INS			0.07	mm	Estimated Total Insulation Thickness (= 2 * film thickness)
DIA			0.54	mm	Bare conductor diameter
AWG			24	AWG	Primary Wire Gauge (Rounded to next smaller standard AWG value)
CM			406	Cmils	Bare conductor effective area in circular mils
CMA				Cmils/Amp	!!! DECREASE CMA (200 < CMA < 600) Decrease L(primary layers),increase NS,smaller Core
LP_TOL	10		10		Tolerance of primary inductance
TRANSFORMER SECONDARY DESIGN PARAMETERS (SINGLE OUTPUT EQUIVALENT)					
Lumped parameters					
ISP			8.83	A	Peak Secondary Current
ISRMS			3.80	A	Secondary RMS Current
IRIPPLE			3.17	A	Output Capacitor RMS Ripple Current
CMS			760	Cmils	Secondary Bare Conductor minimum circular mils
AWGS			21	AWG	Secondary Wire Gauge (Rounded up to next larger standard AWG value)
DIAS			0.73	mm	Secondary Minimum Bare Conductor Diameter
ODS			1.21	mm	Secondary Maximum Outside Diameter for Triple Insulated Wire
VOLTAGE STRESS PARAMETERS					
VDRAIN			692	V	Estimated Maximum Drain Voltage assuming maximum LED string voltage (Includes Effect of Leakage Inductance)
PIVS			146	V	Output Rectifier Maximum Peak Inverse Voltage (calculated at VOVP, excludes leakage inductance spike)
PIVB			92	V	Bias Rectifier Maximum Peak Inverse Voltage (calculated at VOVP, excludes leakage inductance spike)
FINE TUNING (Enter measured values from prototype)					
V pin Resistor Fine Tuning					
RV1			4.00	M-ohms	Upper V Pin Resistor Value
RV2			1.40	M-ohms	Lower V Pin Resistor Value
VAC1			115.0	V	Test Input Voltage Condition1
VAC2			230.0	V	Test Input Voltage Condition2
IO_VAC1			2.10	A	Measured Output Current at VAC1
IO_VAC2			2.10	A	Measured Output Current at VAC2
RV1 (new)			4.00	M-ohms	New RV1
RV2 (new)			1.40	M-ohms	New RV2



V_OV			325.6	V	Typical AC input voltage at which OV shutdown will be triggered
V_UV			72.4	V	Typical AC input voltage beyond which power supply can startup
FB pin resistor Fine Tuning					
RFB1	93.1		93.1	k-ohms	Upper FB Pin Resistor Value
RFB2	1.30E+01		1E+12	k-ohms	Lower FB Pin Resistor Value
VB1	19.01		16.0	V	Test Bias Voltage Condition1
VB2	19.13		20.0	V	Test Bias Voltage Condition2
IO1	2.394		2.10	A	Measured Output Current at Vb1
IO2	2.343		2.10	A	Measured Output Current at Vb2
RFB1 (new)			99.8	k-ohms	New RFB1
RFB2(new)			1.39E+01	k-ohms	New RFB2



9 Heat Sink Assemblies

9.1 Diode Heat Sink

9.1.1 Diode Heat Sink Drawing

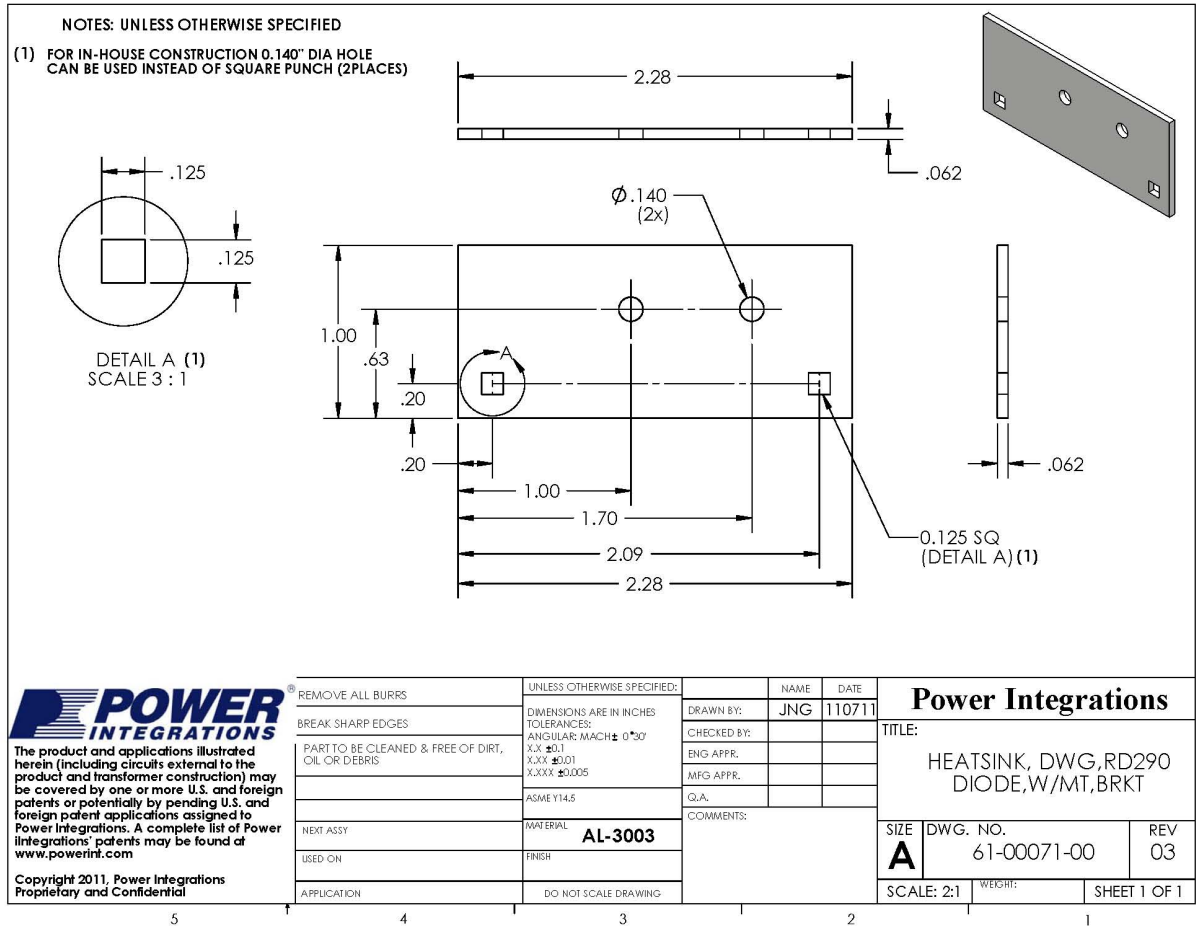

9.1.2 Diode Heat Sink Fabrication Drawing

1 FOR COMPLETED ASSEMBLY
SEE 61-00071-02

**FABRICATOR TO INSTALL
ITEM 2 AS SHOWN.**

ITEM NO.	PART NUMBER	DESCRIPTION	QTY.
1	61-00071-00	HEATSINK, RDK290-DIODE	1
2	60-00016-00	TERMINAL, EYELET, ZIERICK 190	2

POWER INTEGRATIONS

The product and applications illustrated herein (including circuits external to the product and transformer construction) may be covered by one or more U.S. and foreign patents or potentially by pending U.S. and foreign patent applications assigned to Power Integrations. A complete list of Power Integrations' patents may be found at www.powerint.com

Copyright 2011, Power Integrations
Proprietary and Confidential

REMOVE ALL BURRS	UNLESS OTHERWISE SPECIFIED:	NAME	DATE	<p>Power Integrations</p> <p>TITLE: HEATSINK, FAB, DIODE WITH BRKT, PI CUSTOM</p> <p>SIZE A DWG. NO. 61-00071-01 REV 03</p> <p>SCALE: 2:1 WEIGHT: SHEET 1 OF 1</p>
BREAK SHARP EDGES	DIMENSIONS ARE IN INCHES TOLERANCES: ANGULAR: MACH ± 0°30'	DRAWN BY: JNG	110711	
PART TO BE CLEANED & FREE OF DIRT, OIL OR DEBRIS	X.X ±0.1 X.XX ±0.01 X.XXX ±0.005	CHECKED BY:		
	ASME Y14.5	ENG APPR.		
NEXT ASSY	MATERIAL	MFG APPR.		
USED ON	FINISH	Q.A.		
APPLICATION	DO NOT SCALE DRAWING	COMMENTS:		



9.1.3 Diode and Heat Sink Assembly Drawing

(FOR ASSEMBLY REFERENCE)

ITEM NO.	PART NUMBER	DESCRIPTION	QTY.
1	61-00071-01	HEATSINK, RDK290-DIODE	1
2	75-00009-00	SCREW MACHINE PHIL 6-32 X 3/8 SS	2
3	75-00167-00	WASHER FLAT #6 SS, ZINC PLATE, 0.267 OD X 0.143 X 0.032 THK	2
4	60-00035-00	THERMAL GREASE, SILICONE, 5 OZ TUBE	2
6	15-00674-00	600 V, 8 A, ULTRAFAST RECOVERY, 12 ns, TO-220AC	2
7	75-00069-00	NUT, HEX, KEP 6-32, ZINC PLATE	2

REMOVE ALL BURRS	UNLESS OTHERWISE SPECIFIED:	NAME	DATE	Power Integrations TITLE: HEATSINK, ASSY, DIODE WITH BRKT, RDK290, PI CUSTOM SIZE DWG. NO. REV A 61-00071-02 03 SCALE: 1:2 WEIGHT: SHEET 1 OF 1
BREAK SHARP EDGES	DIMENSIONS ARE IN INCHES	DRAWN BY: JNG	110711	
PART TO BE CLEANED & FREE OF DIRT, OIL OR DEBRIS	TOLERANCES: ANGULAR: MACH ± 0°30' X.X ±0.1 X.XX ±0.01 X.XXX ±0.005	CHECKED BY:		
	ASME Y14.5	ENG APPR.		
NEXT ASSY	MATERIAL	MFG APPR.		
USED ON	FINISH	Q.A.		
APPLICATION	DO NOT SCALE DRAWING	COMMENTS:		

POWER INTEGRATIONS
 The product and applications illustrated herein (including circuits external to the product and transformer construction) may be covered by one or more U.S. and foreign patents or potentially by pending U.S. and foreign patent applications assigned to Power Integrations. A complete list of Power Integrations' patents may be found at www.powerint.com
 Copyright 2011, Power Integrations
 Proprietary and Confidential

9.2 eSIP Heat Sink

9.2.1 eSIP Heat Sink Drawing

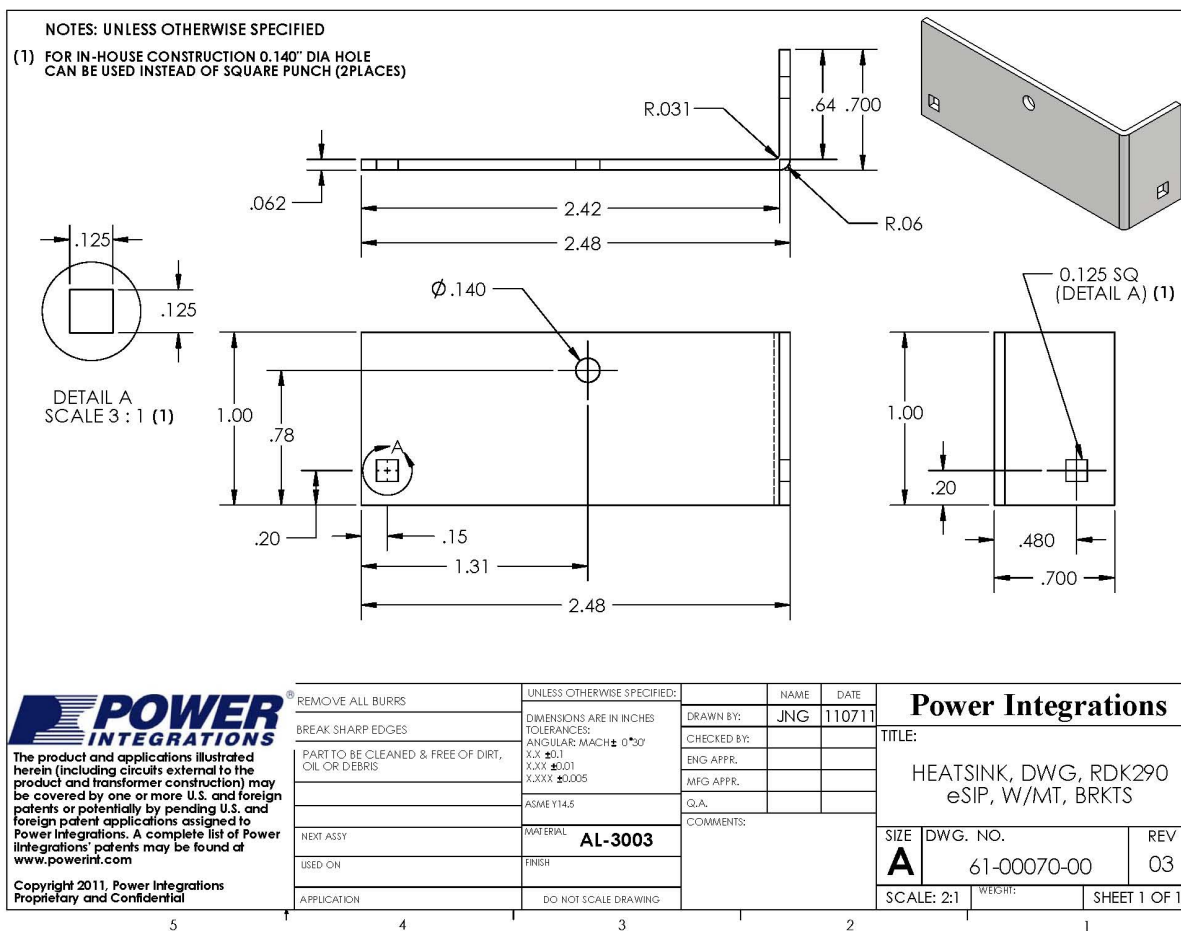

9.2.3 eSIP and Heat Sink Assembly Drawing

(FOR ASSEMBLY REFERENCE)

ITEM NO.	PART NUMBER	DESCRIPTION	QTY.
1	10-00483-00	LINKSWITCH, LNK419EG,eSIP	1
2	60-00042-00	EDGE CLIP, 20.76mm L x 8 mm WX 0,015mm THK	1
3	75-00009-00	SCREW MACHINE PHIL 6-32 X 3/8 SS	1
4	75-00167-00	WASHER FLAT #6 SS, Zinc Plate, 0,267 OD X 0,143 x 0,032 Thk	1
5	75-00069-00	NUT,HEX,KEP6-32, Zinc Plate	1
6	66-00035-00	THERMAL GREASE, SILICONE, 5 OZ TUBE	1
7	61-00070-01	HEATSINK, RDK290-eSIP	1

REMOVE ALL BURRS	UNLESS OTHERWISE SPECIFIED:	NAME	DATE	Power Integrations TITLE: HEATSINK, ASSY, eSIP WITH BRKTS, RDK290, PI CUSTOM SIZE DWG. NO. REV A 61-00070-02 03 SCALE: 1:2 WEIGHT: SHEET 1 OF 1
BREAK SHARP EDGES	DIMENSIONS ARE IN INCHES	DRAWN BY:	JNG 110711	
PART TO BE CLEANED & FREE OF DIRT, OIL OR DEBRIS	TOLERANCES:	CHECKED BY:		
	ANGULAR: MACH ± 0°30'	ENG APPR.		
	X.X ±0.1	MFG APPR.		
	X.XX ±0.01	Q.A.		
	X.XXX ±0.005	COMMENTS:		
NEXT ASSY	MATERIAL			
USED ON	FINISH			
APPLICATION	DO NOT SCALE DRAWING			

POWER INTEGRATIONS
 The product and applications illustrated herein (including circuits external to the product and transformer construction) may be covered by one or more U.S. and foreign patents or potentially by pending U.S. and foreign patent applications assigned to Power Integrations. A complete list of Power Integrations' patents may be found at www.powerint.com
 Copyright 2011, Power Integrations
 Proprietary and Confidential



10 Performance Data

All measurements performed at 25°C room temperature, 50 Hz input frequency otherwise specified.

10.1 Active Mode Efficiency

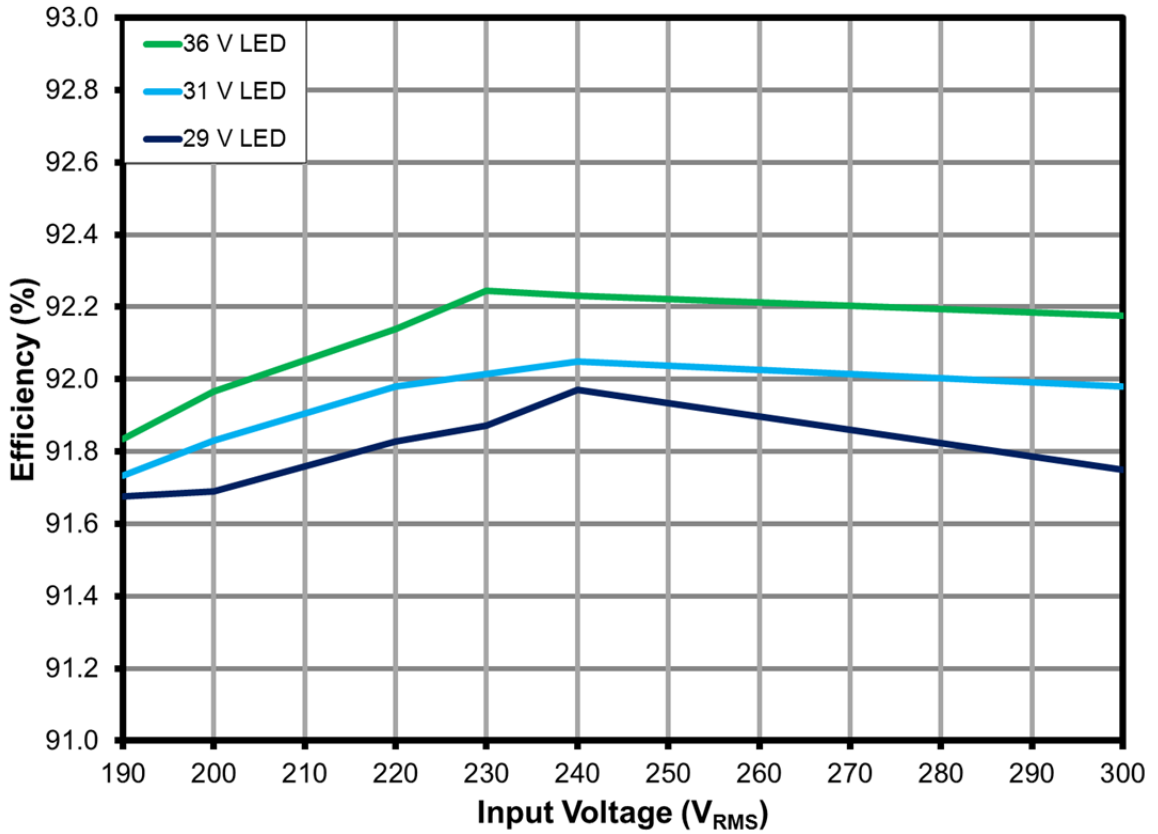

Figure 8 – Efficiency with Respect to AC Input Voltage.



10.2 Line Regulation

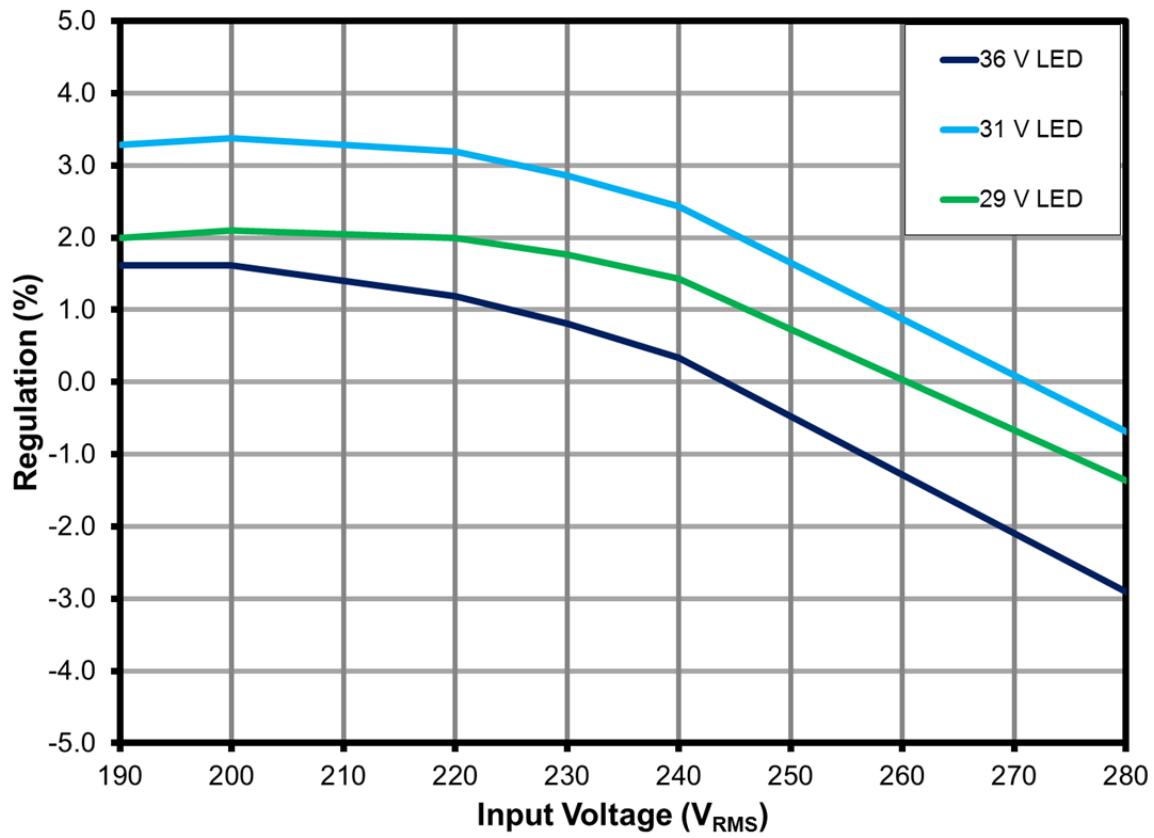

Figure 9 – Line Regulation, Room Temperature.



10.3 Power Factor

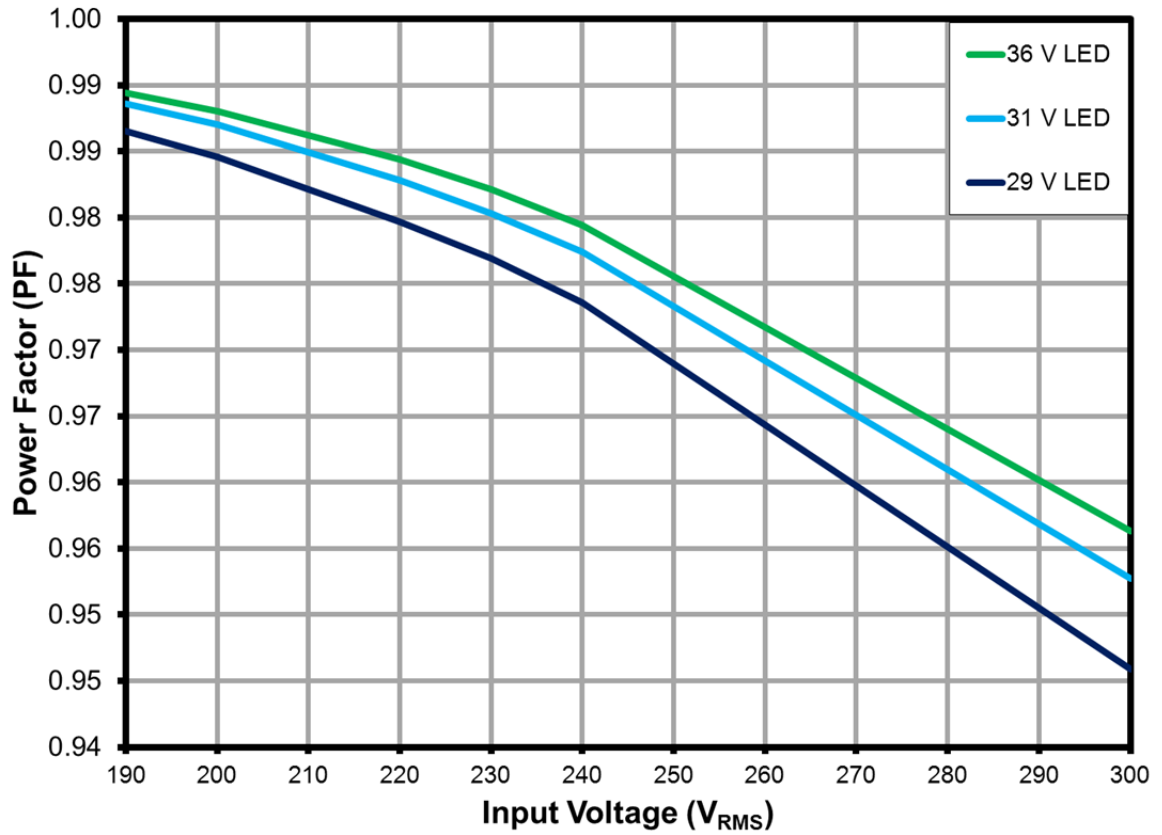

Figure 10 – High Power Factor within the Operating Range.



10.4 %THD

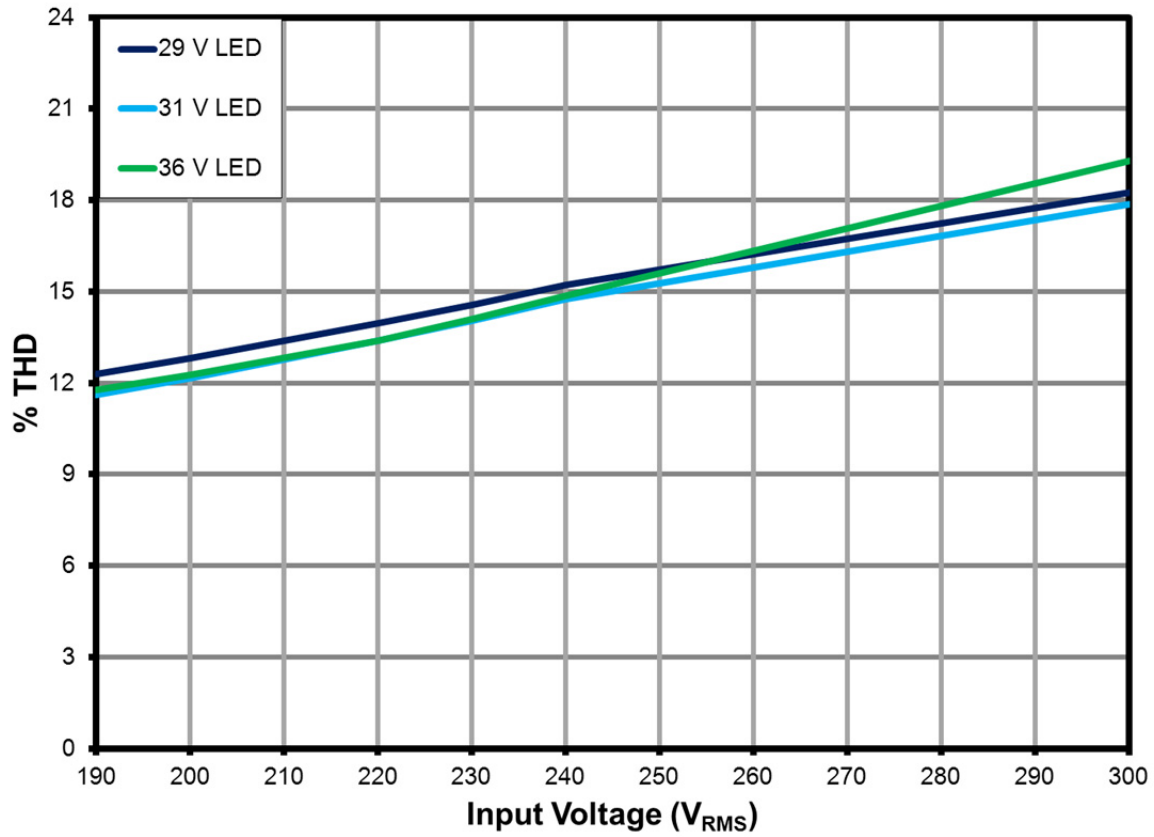

Figure 11 – Very Low %ATHD within the Operating Range.



10.5 Harmonic Currents

The design met the limits for Class C equipment¹ for an active input power of >25 W.

VAC (V _{RMS})	Freq (Hz)	I (mA)	P (W)	PF
230	50.00	357.23	80.6300	0.9819
nth Order	mA Content	% Content	Limit >25 W	Remarks
1	324.20			
2	0.60	0.19%	2.00%	Pass
3	38.80	11.97%	29.46%	Pass
5	15.70	4.84%	10.00%	Pass
7	9.10	2.81%	7.00%	Pass
9	6.50	2.00%	5.00%	Pass
11	5.30	1.63%	3.00%	Pass
13	4.60	1.42%	3.00%	Pass
15	4.40	1.36%	3.00%	Pass
17	3.40	1.05%	3.00%	Pass
19	3.40	1.05%	3.00%	Pass
21	2.70	0.83%	3.00%	Pass
23	2.40	0.74%	3.00%	Pass
25	2.00	0.62%	3.00%	Pass
27	1.70	0.52%	3.00%	Pass
29	1.50	0.46%	3.00%	Pass
31	1.30	0.40%	3.00%	Pass
33	1.10	0.34%	3.00%	Pass
35	0.80	0.25%	3.00%	Pass
37	1.00	0.31%	3.00%	Pass
39	0.70	0.22%	3.00%	Pass
41	0.70	0.22%		
43	0.60	0.19%		
45	0.70	0.22%		
47	0.50	0.15%		

Table 1 – Meets EN61000-3-2 Harmonics Contents Standards for >25 W Rating. 31 V LED String.

¹ IEC6000-3-2 Section 7.3, Table 2.



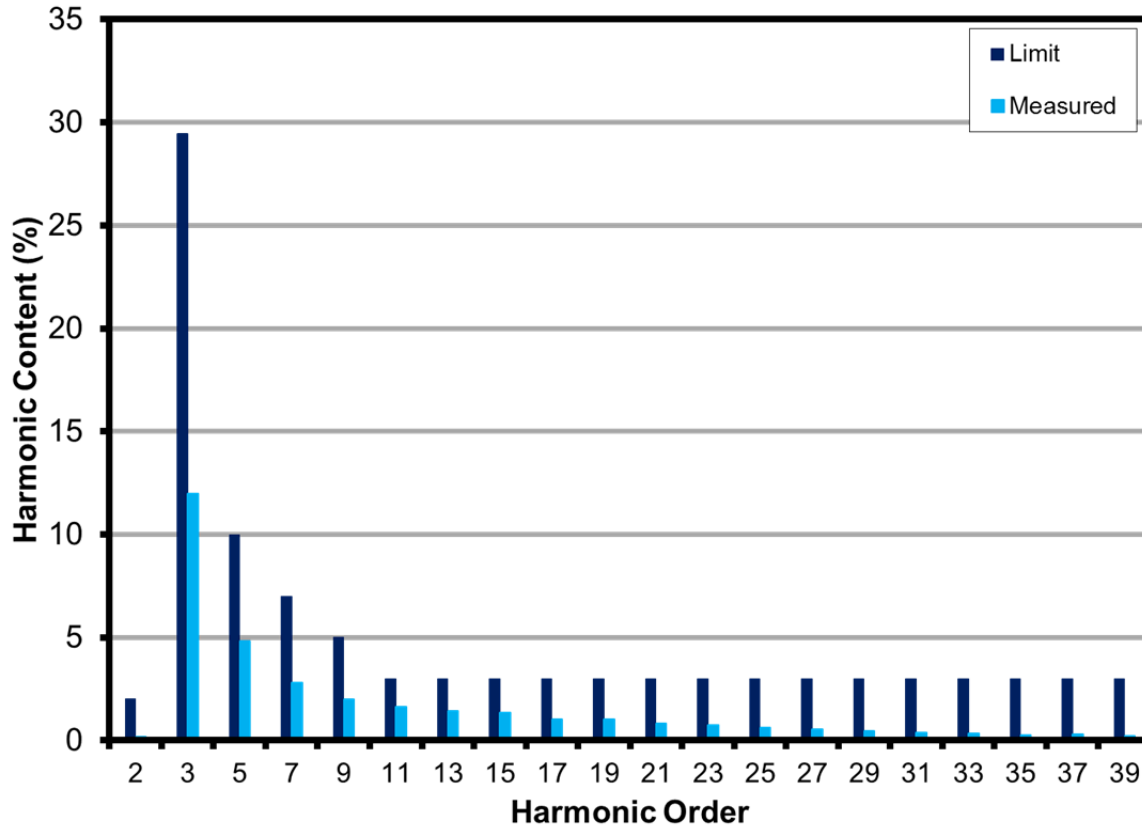

Figure 12 – Meets EN61000-3-2 Harmonics Contents Standards for >25 W Rating. 31 V LED String.



11 Thermal Performance

11.1 Equipment Used

Chamber:	Tenney Environmental Chamber Model No: TJR-17 942
AC Source:	Chroma Programmable AC Source Model No: 6415
Wattmeter:	Yokogawa Power Meter Model No: WT2000
Data Logger:	Monogram SN:1290492

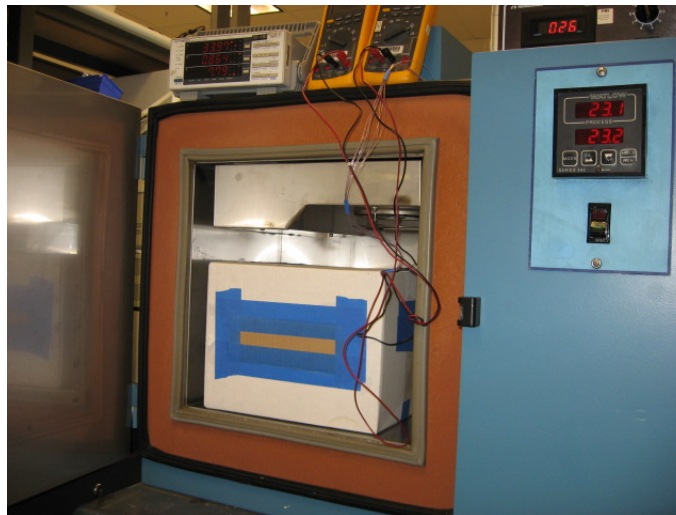

Figure 13 – Thermal Chamber Set-up Showing Box Used to Prevent Airflow Over UUT.

11.2 Thermal Result

Load: 36 V / 2.08 A LED load

Normal Operation Component	Device Temperature (°C)					
	180 V / 50 Hz		230 V / 50 Hz		265 V / 50 Hz	
	Max	OTP	Max	OTP	Max	OTP
Box Internal Ambient (°C)	70.0	89.2	70.0	96.4	70.0	95.5
Transformer (T1)	81.1	105.4	80.9	105.9	84.8	109.8
Output Capacitor (C17)	78.2	96.5	74.4	100.5	77.4	102
Common Mode Choke (L1)	79.7	98.4	73.8	100.6	75.2	100.7
Bridge (BR1)	100.4	119.3	92.1	118.2	92.4	118.0
Snubber TVS (VR1)	100.1	119.5	94.4	119.8	93.3	118.6
LNK420EG (U1)	110.2	131.0	103.1	130.8	104.0	131.2
Output Diode (D9)	90.7	109.1	88.2	113.0	90.5	115.0
Output Diode (D10)	95.4	113.9	93.3	118.0	95.7	120.2

OTP: The ambient temperature was raised until the internal Over-Temperature-Protection of the IC (U1) triggered.



11.3 Thermal Scan

The scan is conducted at ambient temperature of 25°C, 180 VAC / 50 Hz input and 36 V LED string load.

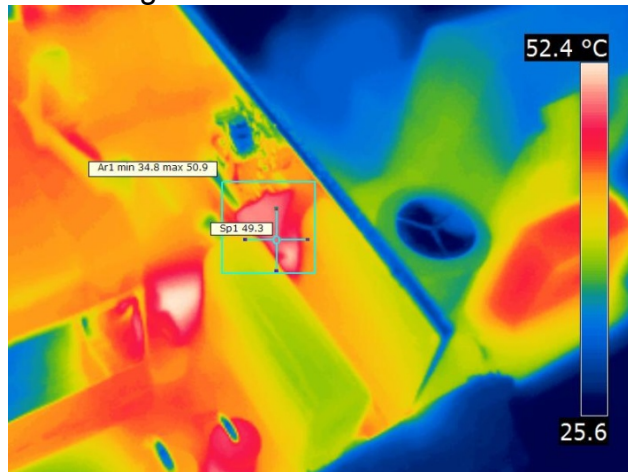

Figure 14 – LNK420EG (U1) Case Temperature.

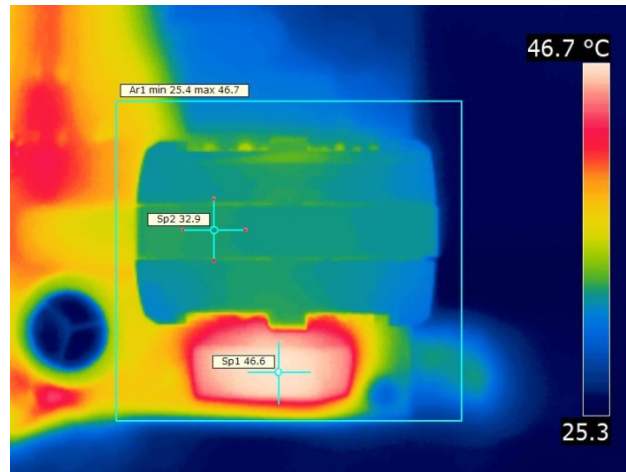

Figure 15 – Bridge Case BR1 (Sp1) and CMC Core L1 (Sp2) Temperature.

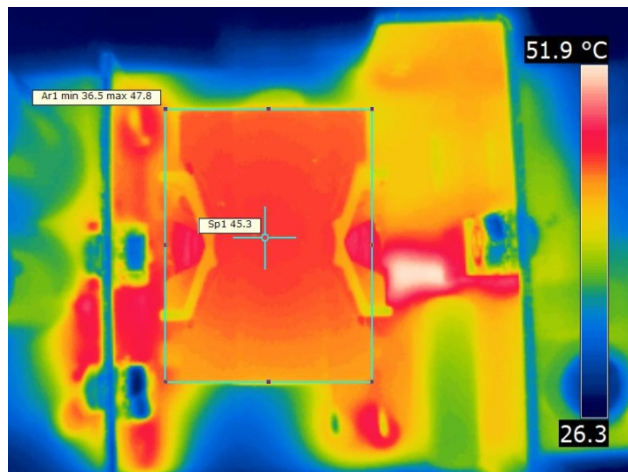

Figure 16 – Transformer Core T1 (Sp1) Temperature.

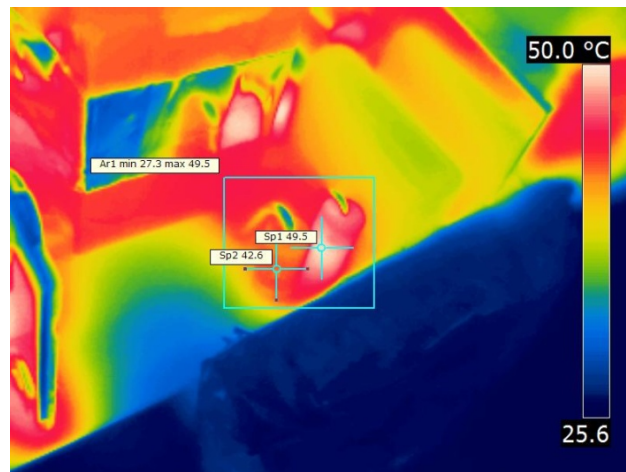

Figure 17 – TVS Diode VR1 (Sp1) and Snubber Diode D3 (Sp2) Case Temperature.



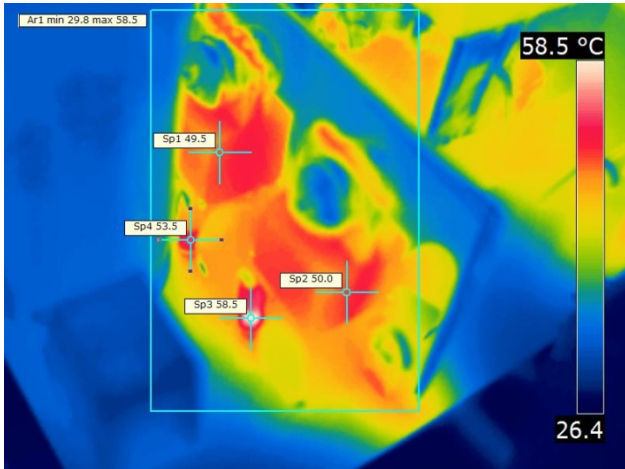

Figure 18 – Output Diode D9, D10 (Sp1, Sp2) Case and Secondary Snubber R17, R19 (Sp3, Sp4) Temperature.



Figure 19 – Blocking Diode D4 (Sp1) Case Temperature.

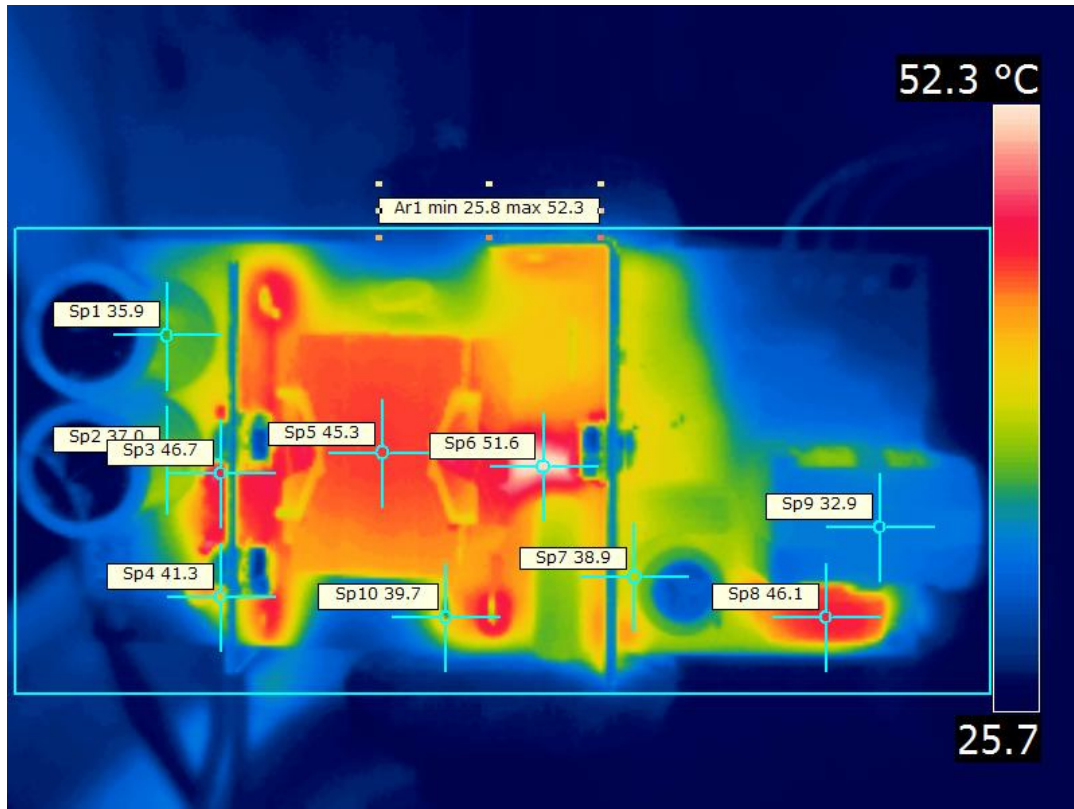

Figure 20 – Overall Board Thermal Image.



12 Waveforms

12.1 Drain Voltage and Current, Normal Operation

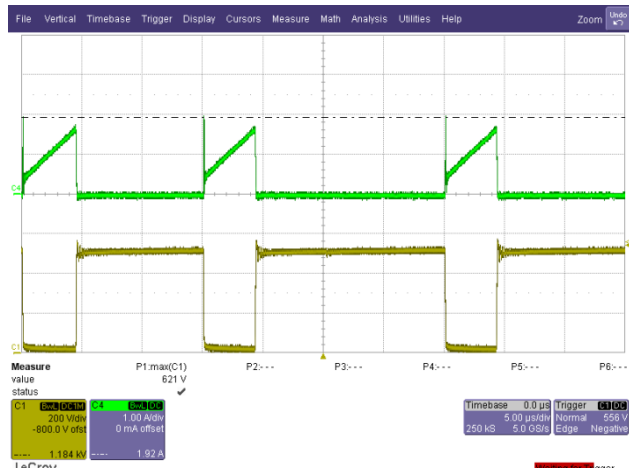

Figure 21 – 300 VAC / 63 Hz, 36 V LED String.
 Measured V_{DRAIN} Stress: 621 V.
 Ch1: V_{DRAIN} , 200 V / div.
 Ch4: I_{DRAIN} , 01 A / div., .5 μ s / div.

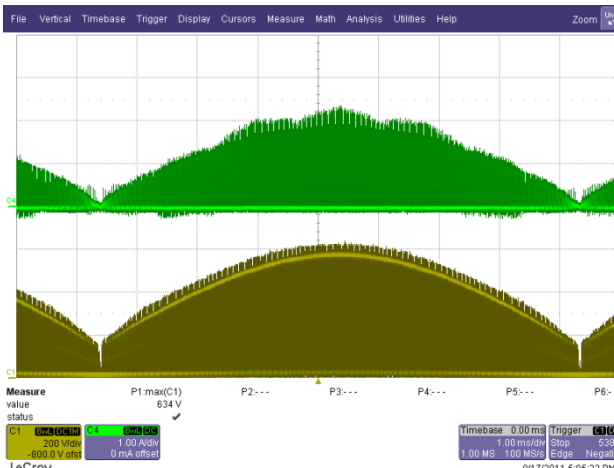

Figure 22 – 300 VAC / 63 Hz, 36 V LED String.
 Measured V_{DRAIN} Stress: 634 V.
 Ch1: V_{DRAIN} , 200 V / div.
 Ch4: I_{DRAIN} , 1 A / div., 1 ms / div.

12.2 Drain Voltage and Current, Start-up Operation

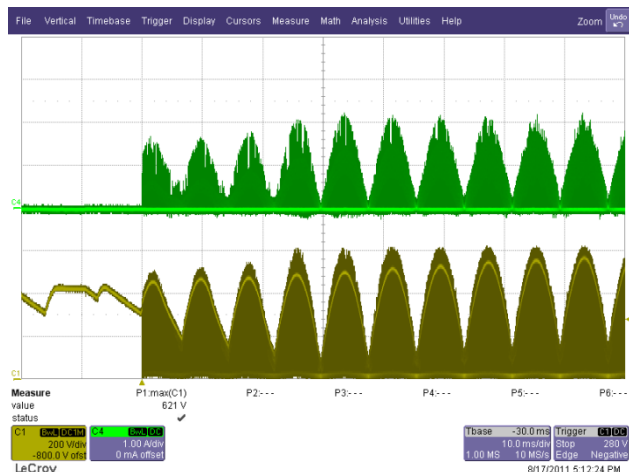

Figure 23 – 300 VAC / 63 Hz, 36 V LED String.
 Measured V_{DRAIN} Stress: 621 V.
 Ch1: V_{DRAIN} , 200 V / div.
 Ch4: I_{DRAIN} , 1 A / div., 10 ms / div.

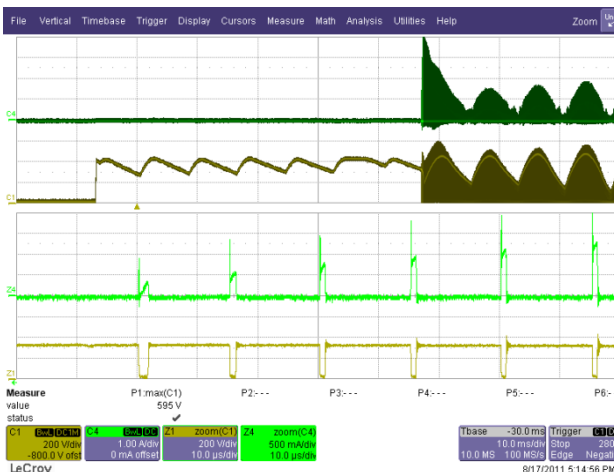

Figure 24 – 300 VAC / 63 Hz, 36 V LED String.
 Measured V_{DRAIN} Stress: 595 V.
 Ch1: V_{DRAIN} , 200 V / div.
 Ch4: I_{DRAIN} , 01 A / div., 10 ms / div.

12.3 Drain Voltage and Current, Output Short

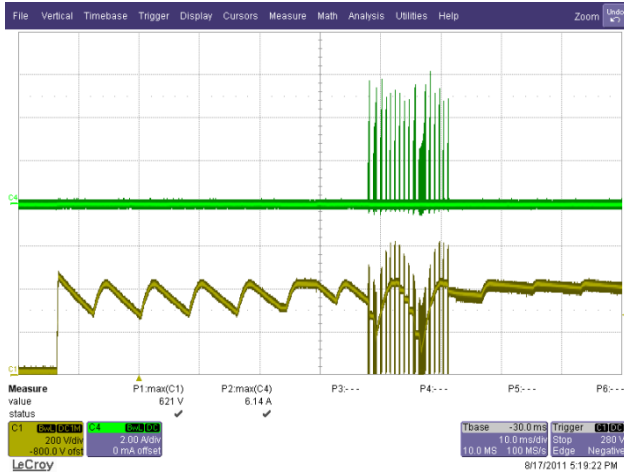

Figure 25 – 300 VAC / 63 Hz, Output Short.
 Measured V_{DRAIN} Stress: 621 V
 Maximum I_{DRAIN} : 6.14 A.
 Ch1: V_{DRAIN} , 200 V / div.
 Ch4: I_{DRAIN} , 2 A / div., 10 ms / div.

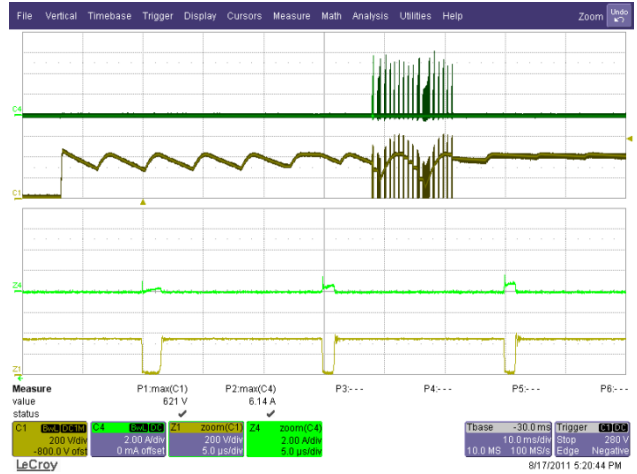

Figure 26 – 300 VAC / 63 Hz, Output Short.
 Measured V_{DRAIN} Stress: 621 V
 Maximum I_{DRAIN} : 6.14 A.
 Ch1: V_{DRAIN} , 200 V / div.
 Ch4: I_{DRAIN} , 2 A / div., 10 ms / div.

12.4 Output Voltage and Output Current Start-up Profile

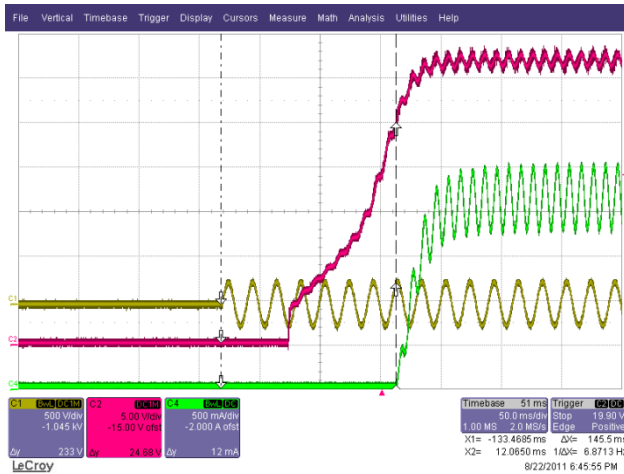

Figure 27 – 180 VAC / 50 Hz, 32 V LED String.
 Ch1: V_{IN} , 500 V / div.
 Ch2: V_{OUT} , 5 V / div.
 Ch4: I_{OUT} , 0.5 A / div., 50 ms / div.

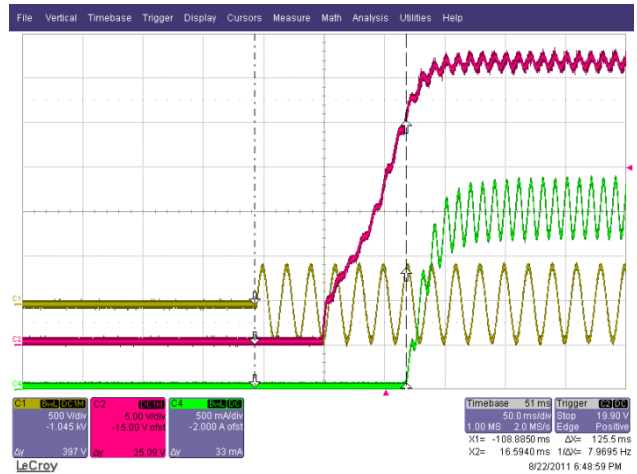

Figure 28 – 300 VAC / 50 Hz, 32 V LED String.
 Ch1: V_{IN} , 500 V / div.
 Ch2: V_{OUT} , 5 V / div.
 Ch4: I_{OUT} , 0.5 A / div., 50 ms / div.

12.5 Output Current at Normal Operation

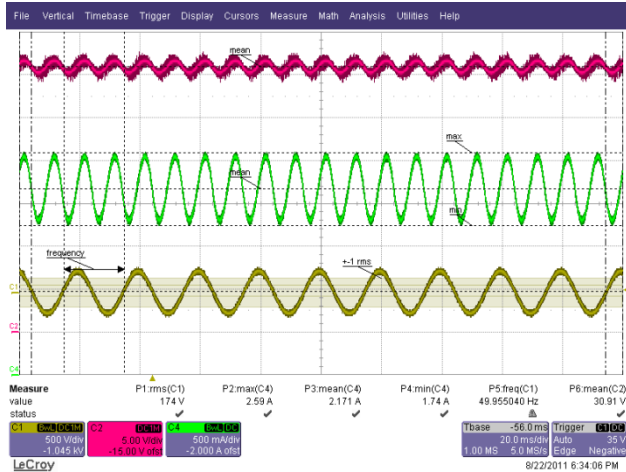

Figure 29 – 180 VAC / 50 Hz, 31 V LED String.
 Ch1: V_{IN} , 500 V / div.
 Ch2: V_{OUT} , 5 V / div.
 Ch4: I_{OUT} , 0.5 A / div., 50 ms / div.

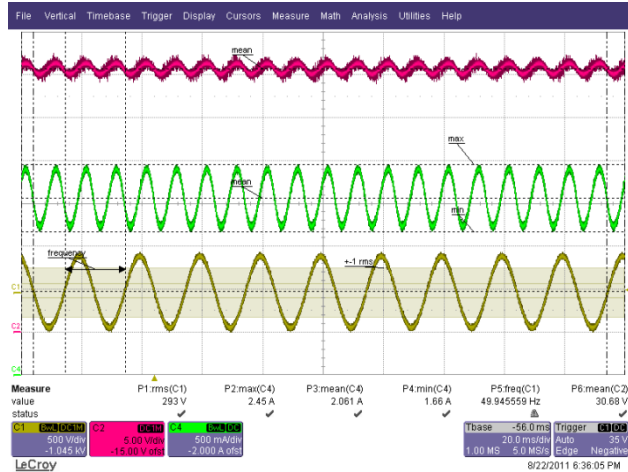

Figure 30 – 300 VAC / 50 Hz, 31 V LED String.
 Ch1: V_{IN} , 500 V / div.
 Ch2: V_{OUT} , 5 V / div.
 Ch4: I_{OUT} , 0.5 A / div., 50 ms / div.

12.6 Line Transient Response

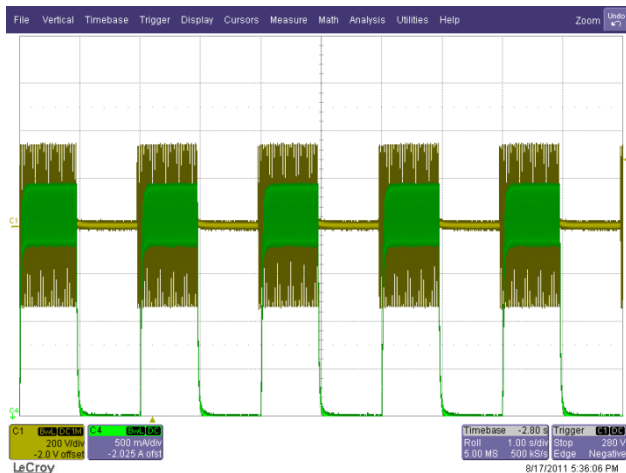

Figure 31 – 230 VAC / 50 Hz, 1 s On – 1 s Off.
 Load: 32 V LED String.
 Ch1: V_{IN} , 200 V / div.
 Ch4: I_{OUT} , 500 mA / div., 1 s / div.

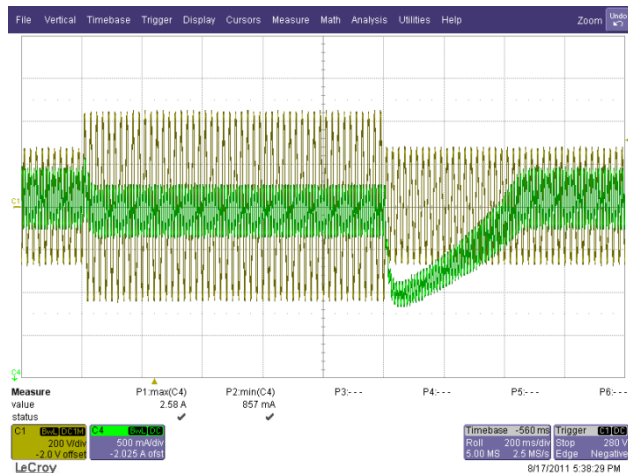

Figure 32 – 180-300-180 VAC / 50 Hz, 1 s Pulse.
 Load: 32 V LED String.
 Ch1: V_{IN} , 200 V / div.
 Ch4: I_{OUT} , 500 mA / div., 200 ms / div.



12.7 Start-up No-load and Normal Operation then No-load

This LED driver is protected by latching OVP circuit and resettable through AC recycle. No component failure was observed.

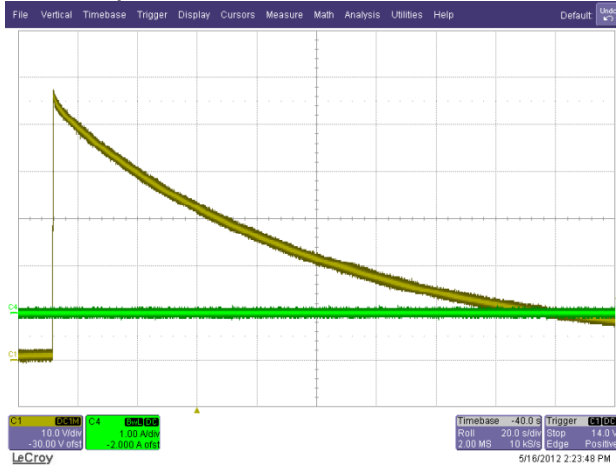

Figure 33 – 300 VAC / 63 Hz Start-up No-load;
 Ch1: V_{OUT} , 10 V / div.
 Ch4: I_{OUT} , 1 mA / div., 20 s / div.



Figure 34 – 300 VAC / 63 Hz, Load is Removed;
 Ch1: V_{OUT} , 10 V / div.
 Ch4: I_{OUT} , 1 A / div., 20 s / div.

12.8 Secondary Diode Voltage Stress

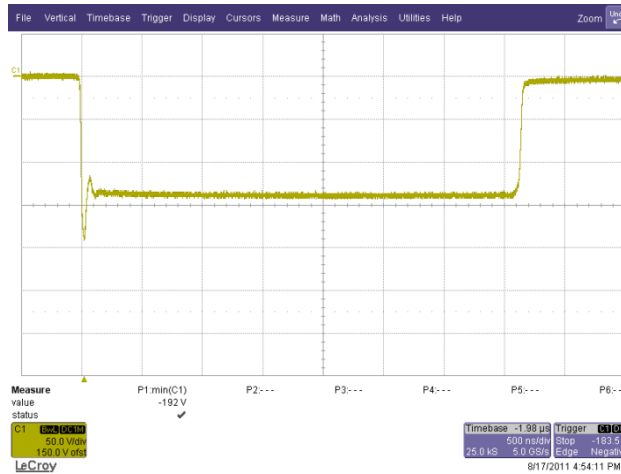

Figure 35 – 300 VAC / 63 Hz, Measured Secondary Voltage Stress: 192 V.
 Ch1: V_{SEC_DIODE} , 50 / div., 500 ns / div.



12.9 Line Surge Waveform

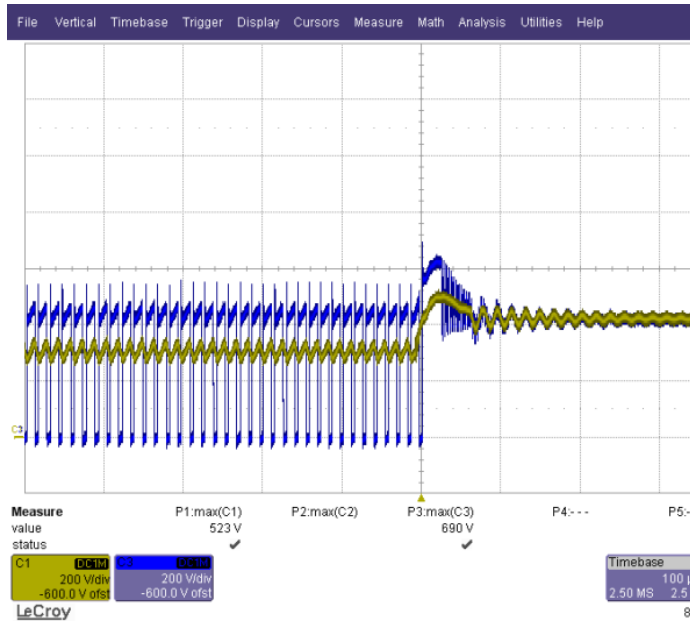

Figure 36 – 230 VAC / 60 Hz, 2 kV Differential Surge.
Voltage Stress (U1): 690 V.
Ch1: V_{BULK} , 200 V / div.
Ch3: V_{SOURCE} , 200 V / div., 100 μs / div.



13 Line Surge

Input voltage was set at 230 VAC / 60 Hz. Output was loaded with 32 V LED string and operation was verified following each surge event.

Differential input line 1.2 / 50 μ s surge testing was completed on two test unit to IEC61000-4-5.

Surge Level (kV)	Input Voltage (VAC)	Injection Location	Injection Phase (°)	Test Result (Pass/Fail)
+2	230	L1 to L2	0	Pass
-2	230	L1 to L2	0	Pass
+2	230	L1 to L2	90	Pass
-2	230	L1 to L2	90	Pass
+4	230	L1-PE	0	Pass
-4	230	L1-PE	0	Pass
+4	230	L1-PE	90	Pass
-4	230	L1-PE	90	Pass
+4	230	L2-PE	0	Pass
-4	230	L2-PE	0	Pass
+4	230	L2-PE	90	Pass
-4	230	L2-PE	90	Pass

Differential input line ring surge testing was completed on two test unit to IEC61000-4-5.

Ring Surge Level (kV)	Input Voltage (VAC)	Injection Location	Injection Phase (°)	Test Result (Pass/Fail)
+2.5	230	L1 to L2	0	Pass
-2.5	230	L1 to L2	0	Pass
+2.5	230	L1 to L2	90	Pass
-2.5	230	L1 to L2	90	Pass

Unit was operating normally under all test conditions.



14 Conducted EMI

14.1 Equipment

Receiver:

Rohde & Schwartz
ESPI - Test Receiver (9 kHz – 3 GHz)
Model No: ESPI3

LISN:

Rohde & Schartz
Two-Line-V-Network
Model No: ENV216

14.2 EMI Test Set-up

LED driver is placed in a conical metal housing (for self-ballasted lamps; CISPR15 Edition 7.2).

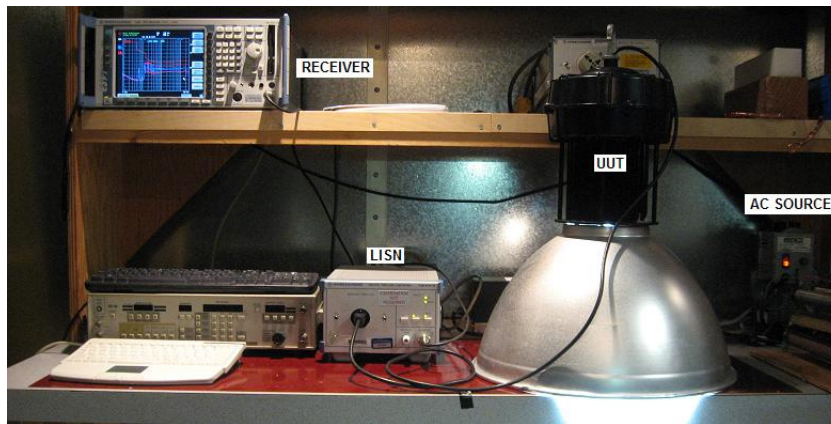

Figure 37 – Conducted Emissions Measurement Set-up.
Showing Down Light Fixture which UUT was Mounted.

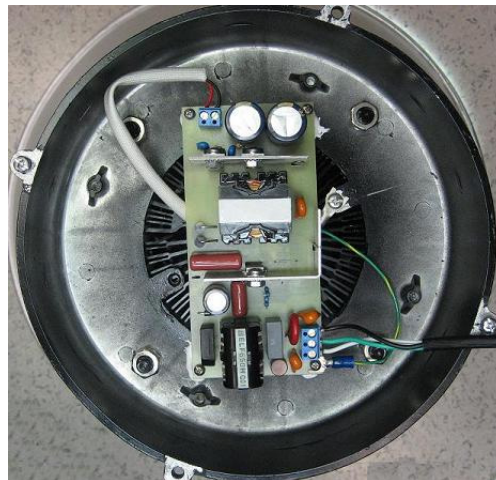

Figure 38 – UUT is Mounted Inside the Down Light Fixture in 3 Conditions: 3 Wire – Chassis Grounded to Earth, 3 Wire Chassis Floating and 2 Wire Connection.





Power Integrations
15.May 12 18:41

RBW 9 kHz
MT 500 ms

Att 10 dB AUTO



Figure 39 – Conducted EMI, Maximum Steady-State Load, 230 VAC, 60 Hz, and EN55015 Limits. 2-Wire Configuration (L-N).



EDIT PEAK LIST (Final Measurement Results)

Trace1: EN55015Q

Trace2: EN55015A

Trace3: ---

	TRACE	FREQUENCY	LEVEL dB μ V		DELTA LIMIT dB
2	Average	66.5026022731 kHz	40.11	L1 gnd	
2	Average	69.2028746009 kHz	38.57	L1 gnd	
2	Average	128.247618558 kHz	48.56	L1 gnd	
2	Average	132.133649648 kHz	46.76	L1 gnd	
2	Average	134.789536006 kHz	53.86	L1 gnd	
2	Average	137.49880568 kHz	51.34	N gnd	
2	Average	167.350252 kHz	35.99	L1 gnd	-19.09
1	Quasi Peak	190.46019728 kHz	54.26	N gnd	-9.75
2	Average	200.175581485 kHz	46.16	N gnd	-7.43
1	Quasi Peak	267.135089486 kHz	45.68	L1 gnd	-15.51
2	Average	267.135089486 kHz	36.98	N gnd	-14.22
1	Quasi Peak	332.507282579 kHz	42.00	L1 gnd	-17.38
1	Quasi Peak	13.0733860985 MHz	44.51	L1 gnd	-15.48
2	Average	13.0733860985 MHz	37.30	L1 gnd	-12.69

Figure 40 – Conducted EMI Margin for the Above Scan.





Power Integrations
16.May 12 08:46

RBW 9 kHz
MT 500 ms

Att 10 dB AUTO

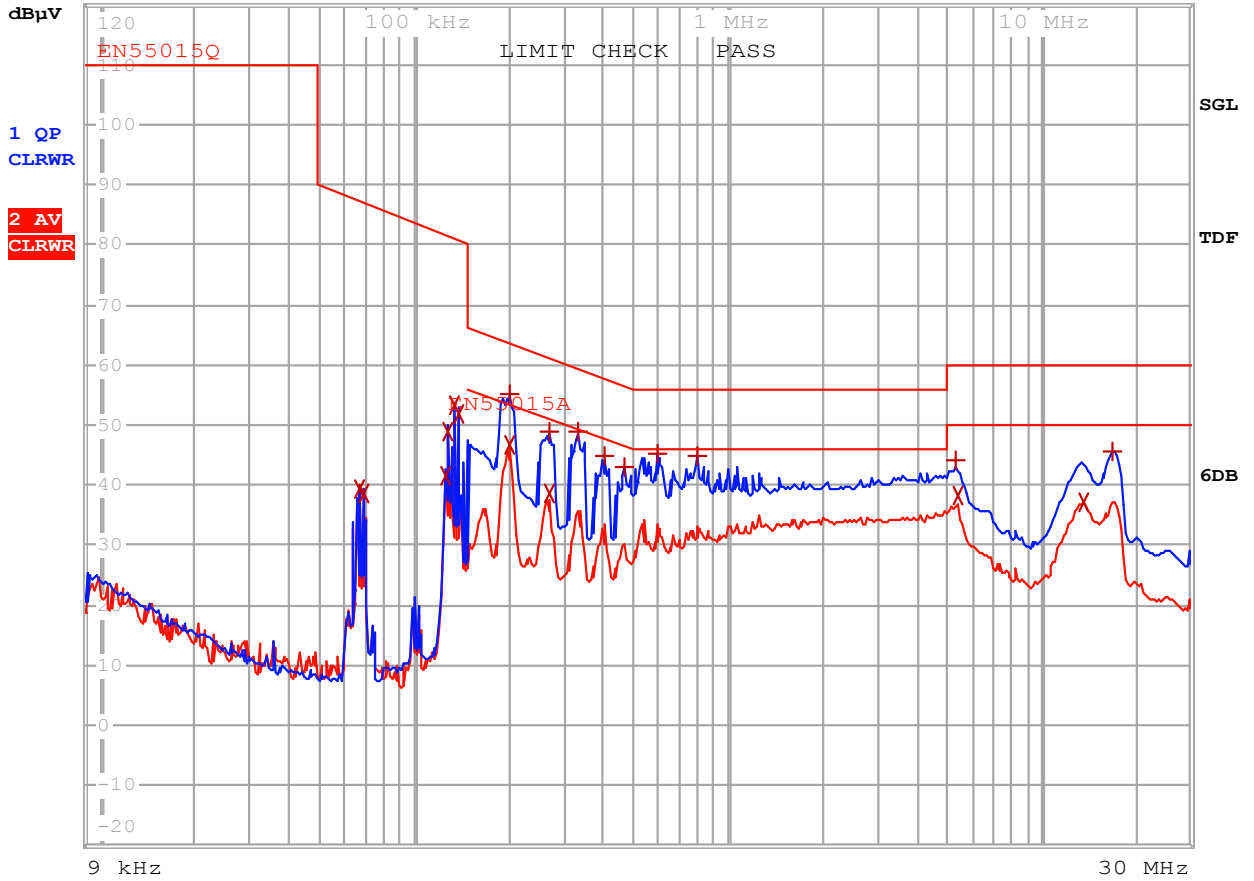

Figure 41 – Conducted EMI, Maximum Steady-State Load, 230 VAC, 60 Hz, and EN55015 Limits. 3-Wire Configuration (L-N-Earth), Chassis Connected to Earth Terminal.



EDIT PEAK LIST (Final Measurement Results)

Trace1: EN55015Q
 Trace2: EN55015A
 Trace3: ---

	TRACE	FREQUENCY	LEVEL dB μ V		DELTA LIMIT dB
2	Average	66.5026022731 kHz	39.41	L1 gnd	
2	Average	69.2028746009 kHz	38.71	L1 gnd	
2	Average	125.720633819 kHz	41.61	N gnd	
2	Average	128.247618558 kHz	48.95	N gnd	
2	Average	134.789536006 kHz	53.44	N gnd	
2	Average	137.49880568 kHz	51.91	N gnd	
1	Quasi Peak	200.175581485 kHz	55.03	N gnd	-8.57
2	Average	200.175581485 kHz	46.53	N gnd	-7.06
1	Quasi Peak	267.135089486 kHz	49.06	N gnd	-12.14
2	Average	267.135089486 kHz	38.59	N gnd	-12.61
1	Quasi Peak	332.507282579 kHz	48.78	N gnd	-10.60
1	Quasi Peak	401.705024172 kHz	44.73	N gnd	-13.08
1	Quasi Peak	466.367062279 kHz	42.93	L1 gnd	-13.64
1	Quasi Peak	598.084042089 kHz	45.13	L1 gnd	-10.87
1	Quasi Peak	798.145472681 kHz	44.76	L1 gnd	-11.24
1	Quasi Peak	5.28619370567 MHz	44.23	N gnd	-15.76
2	Average	5.39244619915 MHz	38.08	N gnd	-11.91
2	Average	13.6042179984 MHz	36.99	L1 gnd	-13.00
1	Quasi Peak	16.9333859021 MHz	45.59	L1 gnd	-14.40

Figure 42 – Conducted EMI Margin for the Above Scan.





Power Integrations
16.May 12 09:43

RBW 9 kHz
MT 500 ms

Att 10 dB AUTO



Figure 43 – Conducted EMI, Maximum Steady State Load, 230 VAC, 60 Hz, and EN55015 Limits. 3-Wire Configuration (L-N-Earth), Chassis Floating.



EDIT PEAK LIST (Final Measurement Results)						
Trace1:		EN55015Q				
Trace2:		EN55015A				
Trace3:		---				
	TRACE	FREQUENCY	LEVEL dB μ V			DELTA LIMIT dB
2	Average	66.5026022731 kHz	39.64	L1	gnd	
2	Average	69.2028746009 kHz	38.83	L1	gnd	
2	Average	128.247618558 kHz	48.37	N	gnd	
2	Average	134.789536006 kHz	52.06	N	gnd	
2	Average	137.49880568 kHz	52.04	N	gnd	
2	Average	167.350252 kHz	36.12	N	gnd	-18.97
1	Quasi Peak	200.175581485 kHz	54.58	N	gnd	-9.02
2	Average	200.175581485 kHz	46.38	N	gnd	-7.22
1	Quasi Peak	267.135089486 kHz	48.15	N	gnd	-13.05
2	Average	267.135089486 kHz	38.08	N	gnd	-13.11
1	Quasi Peak	332.507282579 kHz	47.21	N	gnd	-12.17
1	Quasi Peak	401.705024172 kHz	42.56	N	gnd	-15.24
1	Quasi Peak	466.367062279 kHz	40.51	L1	gnd	-16.06
1	Quasi Peak	598.084042089 kHz	42.47	L1	gnd	-13.52
1	Quasi Peak	798.145472681 kHz	42.12	L1	gnd	-13.87
1	Quasi Peak	2.0745979178 MHz	37.30	L1	gnd	-18.70
1	Quasi Peak	12.8157887448 MHz	43.39	L1	gnd	-16.60
2	Average	12.8157887448 MHz	36.15	L1	gnd	-13.84
1	Quasi Peak	30 MHz	61.82	N	gnd	1.82
2	Average	30 MHz	42.85	N	gnd	-7.14

Figure 44 – Conducted EMI Margin for the Above Scan. 3-Wire Configuration (L-N-Earth), Chassis Floating.



15 Revision History

Date	Author	Revision	Description and Changes	Reviewed
04-Jun-12	JD	1.1	Initial Release	Apps & Mktg
12-Oct-12	KM	1.2	Updated Power Supply Specification Table	

