



Title	<i>Reference Design Report for a 7 W Non-Dimmable, Non-Isolated Buck LED Driver Using LYTSwitch™-0 LYT0006D</i>
Specification	190 VAC – 265 VAC Input; 85 V, 82 mA Output
Application	A17 / A19 LED Driver Lamp Replacement
Author	Applications Engineering Department
Document Number	RDR-378
Date	October 4, 2013
Revision	1.0

Summary and Features

- Single-stage power factor corrected (>0.5 at 230 V) and accurate constant current (CC) output
- Low cost, low component count and small PCB footprint solution
- Highly energy efficient, 91% across VAC input range
- Fast start-up time (<100 ms) – no perceptible delay
- Integrated protection and reliability features
 - Single-shot no-load protection
 - Output short-circuit protected with auto-recovery
 - Auto-recovering thermal shutdown with large hysteresis protects both components and PCB
 - No damage during brown-out conditions
- Meets IEC ring wave, differential line surge and EN55015 conducted EMI

PATENT INFORMATION

The products and applications illustrated herein (including transformer construction and circuits external to the products) may be covered by one or more U.S. and foreign patents, or potentially by pending U.S. and foreign patent applications assigned to Power Integrations. A complete list of Power Integrations' patents may be found at www.powerint.com. Power Integrations grants its customers a license under certain patent rights as set forth at <http://www.powerint.com/ip.htm>.

Table of Contents

1	Introduction.....	3
2	Power Supply Specification	5
3	Schematic.....	6
4	Circuit Description	7
4.1	Input EMI Filtering	7
4.2	LYTSwitch-0.....	7
4.3	Output Rectification	7
4.4	Output Feedback.....	7
4.5	No-Load Protection	8
5	PCB Layout	9
6	Bill of Materials	10
7	Inductor Design Spreadsheet	11
8	Performance Data	13
8.1	Active Mode Efficiency	14
8.2	Output Current Regulation.....	15
8.2.1	Output Current Regulation Across Line and Load	15
9	Thermal Performance.....	16
9.1	Equipment Used.....	16
9.2	Thermal Result.....	18
9.2.1	Load: 85 V / 82 m A LED Load.....	18
9.3	Thermal Scan	19
10	Waveforms.....	20
10.1	Drain Voltage, Current Normal Operation.....	20
10.2	Drain Voltage and Current When Output Short	21
10.3	Drain Voltage and Current Start-up Profile	21
10.4	Output Current Start-up Profile	22
10.5	Input-Output Profile	23
10.6	Line Sag and Surge.....	24
10.7	One Shot No-Load Protection	25
10.8	Brown-out / Brown-in	26
11	Line Surge.....	27
12	Conducted EMI	29
13	Revision History	32

Important Note:

Although this board is designed to satisfy safety isolation requirements, the engineering prototype has not been agency approved. Therefore, all testing should be performed using an isolation transformer to provide the AC input to the prototype board.



1 Introduction

This document describes a cost-effective power supply utilizing the LYTSwitch™-0 family (LYT0006D) in a highly compact buck topology.

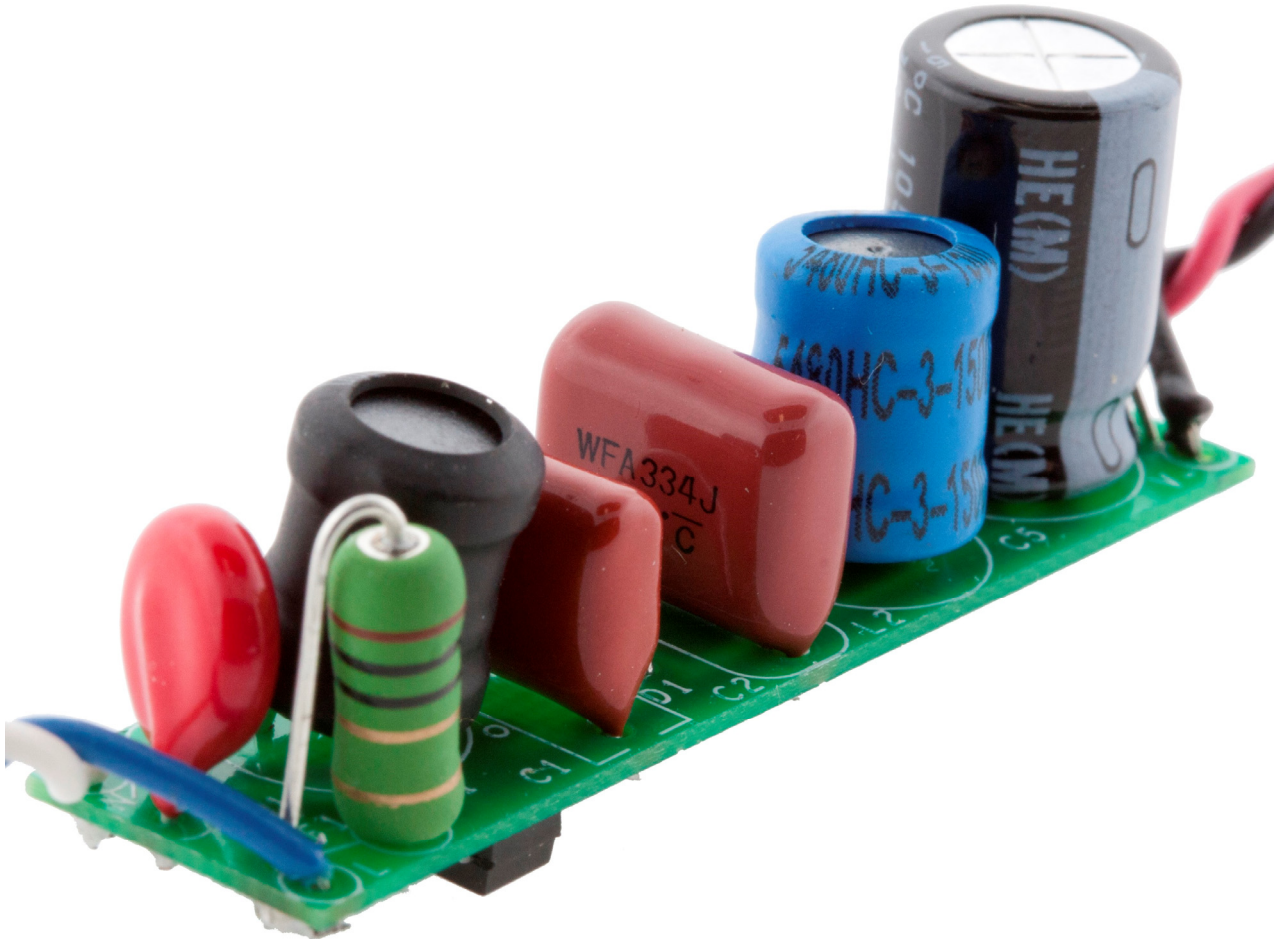

Figure 1 – Populated Circuit Board

This power supply operates over an input voltage range of 190 VAC to 265 VAC. The DC bus voltage is high enough to support an 85 V output when using a buck topology - in a buck converter the output voltage must always be lower than the input voltage. The output voltage is also limited by the maximum duty cycle of the LYTSwitch-0 (which also requires the input voltage to be larger than the output voltage).

The reference design is not limited for retrofit lamp application; the design layout can be easily modified to fit in LED tube or ballast applications.



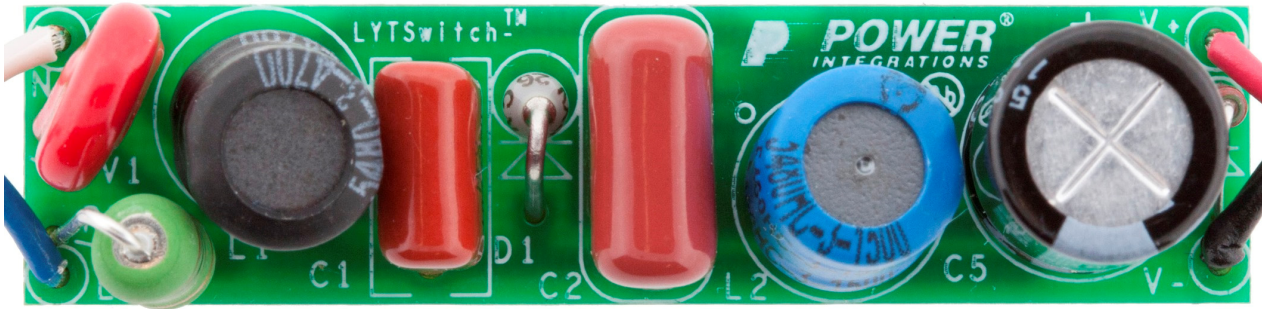

Figure 2 – Populated Circuit Board, Top View.

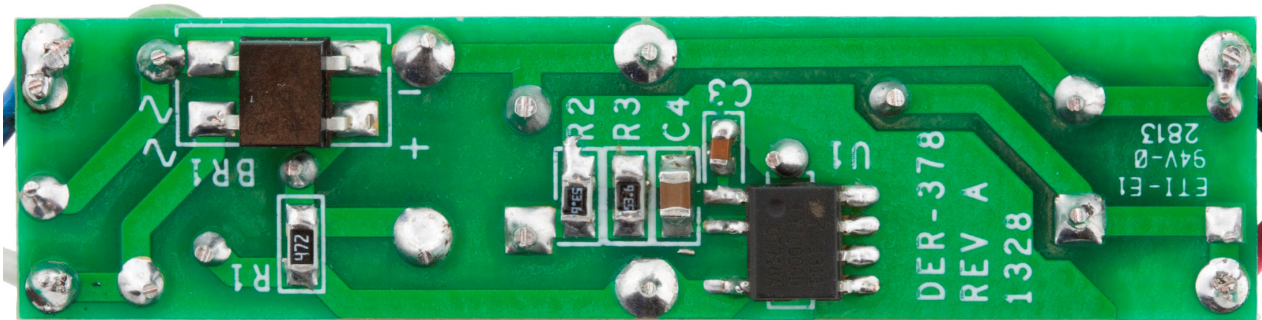

Figure 3 – Populated Circuit Board, Bottom View.



2 Power Supply Specification

The table below represents the minimum acceptable performance for the design. Actual performance is listed in the results section.

Description	Symbol	Min	Typ	Max	Units	Comment
Input						
Voltage Operation	V_{IN}	190		265	VAC	2 Wire – no P.E. Operating frequency is not limited. Adjust sense resistor if application is for 400 Hz line.
Frequency	f_{LINE}	47	50/60		Hz	
Output						
Output Voltage	V_{OUT}	83	85	88	V	±4% at 200 VAC - 240 VAC
Output Current	I_{OUT}		82		mA	
Total Output Power						
Continuous Output Power	P_{OUT}		7		W	
Efficiency						
240 VAC; 85 V LED	η	91			%	Measured at P_{OUT} , 25 °C
Power Factor						
240 VAC; 85 V LED	PF	0.5				Measured at P_{OUT} , 25 °C
Environmental						
Conducted EMI		Meets CISPR22B / EN55015B				
Line Surge Differential Mode (L1-L2)			0.5		kV	1.2/50 μ s surge, IEC 1000-4-5, Series Impedance: Differential Mode: 2 Ω
Ring Wave (100 kHz) Differential Mode (L1-L2)			2.5		kV	500 A short circuit Series Impedance: Differential Mode: 2 Ω
Ambient Temperature	T_{AMB}	-10	25		°C	Free convection, sea level



3 Schematic

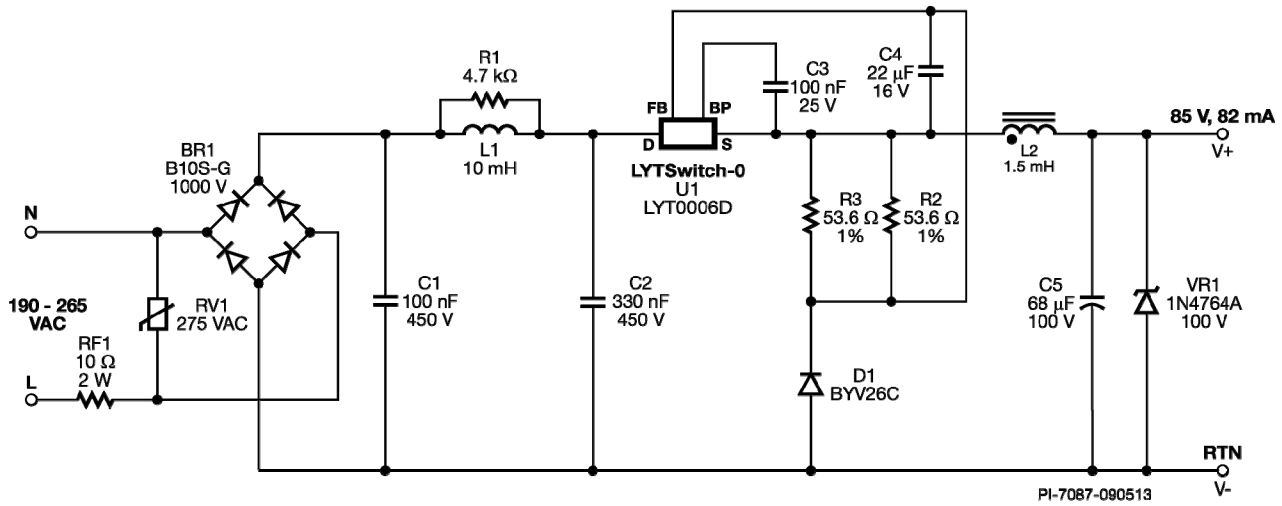

Figure 4 – Schematic. Zener Diode VR1 is Optional, Providing One-time No-load Protection. Refer to AN-60 for Additional OVP Options.



4 Circuit Description

The power supply shown in Figure 3 uses the LYT0006D (U1) in a high-side buck configuration to deliver a constant 82 mA current at an output voltage of 85 VDC. The power supply is designed for driving LEDs, which should always be driven with a constant current (CC).

4.1 Input EMI Filtering

Fuse RF1 provides short circuit protection. Bridge BR1 provides full wave rectification for good power factor. Capacitor C1, C2 and common-mode choke L1 form a π filter in order meet conducted EMI standards. Capacitor C1 and C2 are also used for energy storage reducing line noise and protecting against line surge.

4.2 LYTSwitch-0

The LYTSwitch-0 family is fully optimized to enable the design of a simple, cost-effective LED driver with good line and temperature regulation from 0 to 100 °C (LYTSwitch-0 case temperature). The PIXIs spreadsheet was used to achieve the best possible line regulation by optimizing the choices of power inductor and sense resistor. Optimize the total input capacitance to design for the highest possible power factor and line load regulation.

The LYTSwitch-0 family has a built-in thermal limit to protect the power supply in the event that temperature rises beyond the suitable level of operation.

The buck converter stage consists of the integrated power MOSFET switch within LYT0006D (U1), a freewheeling diode (D1), sense resistors (R2, R3), power inductor L2 and output capacitor (C5). The converter is operating mostly in discontinuous mode (DCM) in order to limit the cycles of reverse current. A fast freewheeling diode was selected to minimize switching losses.

A standard off-the-shelf inductor was used in the power converter to reduce cost.

4.3 Output Rectification

Fast output diode (D1) was used to achieve good efficiency and for thermal management. Normally for LED applications, the ambient temperature is above 70 °C. A device with low t_{RR} (<35 ns) is recommended.

4.4 Output Feedback

Regulation is maintained by skipping switching cycles. As the output current rises, the voltage into the FEEDBACK (FB) pin also rises. If this voltage exceeds V_{FB} then subsequent switching cycles will be skipped until the voltage drops below V_{FB} . Current is sensed via R2, R3 and filtered by C4, then fed to the FB pin for accurate regulation. The key to achieving good line regulation is in balancing the power inductor and sense resistor values after the minimum inductance has been calculated.



The bypass capacitor (C4) is connected between the FB pin and the SOURCE (S) pin and helps reduce power loss during output current sensing. The capacitor acts to sample-and-hold the feedback current information for the FB pin. No limiting resistor is required between the FB pin and C4, because the peak voltage will not exceed the maximum rating of the device.

4.5 No-Load Protection

An optional, one-shot, no-load protection circuit is incorporated into the design. In case of accidental no-load operation, the output capacitor is protected by VR1. Zener diode VR1 would need to be replaced after a failure. Refer to AN-60 for other OVP design options.

In operation (LED retrofit lamp), the load is always connected, so VR1 could be removed to save cost. If this option is utilized, to protect during board level testing (in manufacturing) 70 VAC can be applied to the input; if no output current is measured then the load is not connected. This test will allow safe, non-destructive initial power up of the board, without the need of an OV protection circuit.



5 PCB Layout

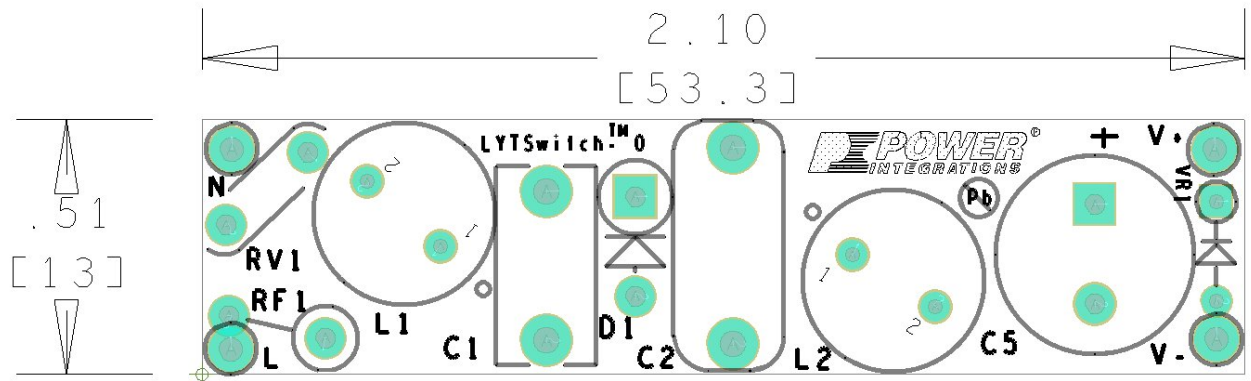

Figure 5 – Printed Circuit Layout, Top View.

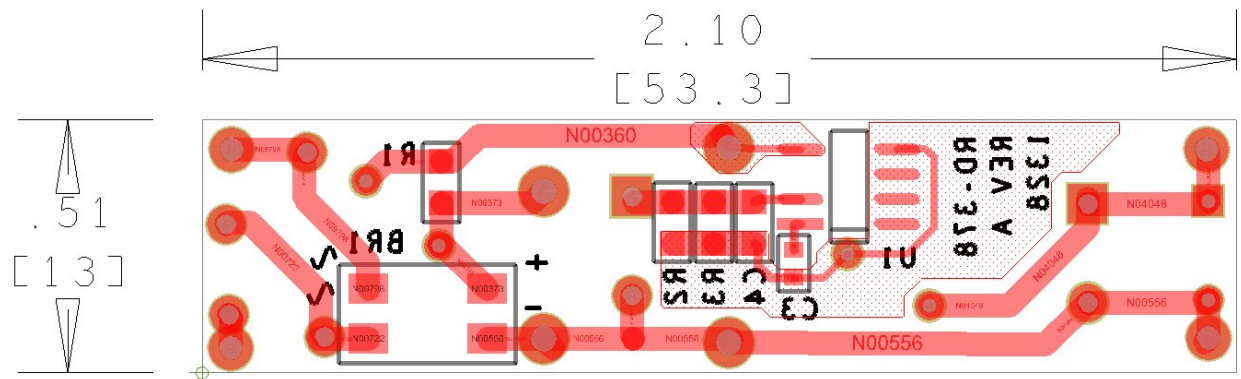

Figure 6 – Printed Circuit Layout, Bottom View.



6 Bill of Materials

Item	Qty	Ref Des	Description	Manufacturer P/N	Manufacturer
Electrical					
1	1	BR1	1000 V, 0.8 A, Bridge Rectifier, SMD, MBS-1, 4-SOIC	B10S-G	Comchip Technology
2	1	C1	100 nF, 450 V, Film	MEXXD31004JJ1	Duratech
3	1	C2	330 nF, 450 V, METALPOLYPRO	ECW-F2W334JAQ	Panasonic
4	1	C3	100 nF, 25 V, Ceramic, X7R, 0603	VJ0603Y104KNXAO	Vishay
5	1	C4	22 μ F, 16 V, Ceramic, X7R, 0805	C2012X5R1C226K	TDK
6	1	C5	68 μ F, 100 V, Electrolytic, Gen. Purpose, (10 x 16)	UHE2A680MPD	Nichicon
7	1	D1	600 V, 1 A, Ultrafast Recovery, 30 ns, SOD57	BYV26C	Philips
8	1	L1	10 mH, 0.076 A, 20%	RL-5480-3-10000	Renco Elect
9	1	L2	1.5 mH, 0.250 A, 10%	RL-5480HC-3-1500	Renco Elect
10	1	R1	4.7 k Ω , 5%, 1/8 W, Thick Film, 0805	ERJ-6GEYJ472V	Panasonic
11	2	R2 R3	53.6 Ω , 1%, 1/8 W, Thick Film, 0805	ERJ-6ENF53R6V	Panasonic
12	1	RF1	10 Ω , 5%, 2 W, Wirewound, Fusible	FW20A10R0JA	Bourns
13	1	RV1	275 V, 23 J, 7 mm, RADIAL	V275LA4P	Littlefuse
14	1	U1	LYTSwitch-0, SMD-8C	LYT0006D	Power Integrations
15	1	VR1	100 V, 5%, 1 W, DO-41	1N4764A-TAP	Vishay
Mechanical					
16	1	WIRE(V-)	Wire, UL1007, # 24 AWG, Blk, PVC, 4"	1007-24/7-0	Anixter
17	1	WIRE (L)	Wire, UL1007, #24 AWG, Blu, PVC, 4"	1007-24/7-6	Anixter
18	1	WIRE(V+)	Wire, UL1007, #24 AWG, Red, PVC, 4"	1007-24/7-2	Anixter
19	1	WIRE(N)	Wire, UL1007, #24 AWG, Wht, PVC, 4"	1007-24/7-9	Anixter
20	1	PCB	FR4, 0.31, 1 Oz Cu (0.51" X 2.1")		



7 Inductor Design Spreadsheet

ACDC_LYTSwitchZero_052813; Rev.0.8; Copyright Power Integrations 2013	INPUT	INFO	OUTPUT	UNIT	LYTSwitchZero_Rev_0-8.xls: LYTSwitchZero Design Spreadsheet
INPUT VARIABLES					
VACMIN	190		190	Volts	Minimum AC Input Voltage
VACNOM	230		230		
VACMAX	265		265	Volts	Maximum AC Input Voltage
FL	50		50	Hertz	Line Frequency
VO	85		85	Volts	Output Voltage
IO	82		82	mA	Output Current
Pout			6.97	W	
EFFICIENCY	0.91		0.91		Overall Efficiency Estimate (Adjust to match Calculated, or enter Measured Efficiency)
CIN	0.43		0.43	uF	Input Filter Capacitor
Input Stage Resistance	4.7		4.7	ohms	Input Stage Resistance, Fuse & Filtering
Switching Topology			Buck		Type of Switching topology
DC INPUT VARIABLES					
VMIN			85	Volts	Minimum DC Bus Voltage
VMAX			374.766594	Volts	
LYTSwitchZero					
LYTSwitchZero	LYT0006		LYT0006		
ILIMIT			0.375	Amps	Typical Current Limit
ILIMIT_MIN			0.33275	Amps	Minimum Current Limit
ILIMIT_MAX			0.401	Amps	Maximum Current Limit
FSMIN			62000	Hertz	Minimum Switching Frequency
IRMS			85.25298	mA	Expected RMS current through LYTSwitch
VDS			4.8375	Volts	Maximum On-State Drain To Source Voltage drop
DIODE					
VD			0.7	Volts	Freewheeling Diode Forward Voltage Drop
VRR			600	Volts	Recommended PIV rating of Freewheeling Diode
IF			1	Amps	Recommended Diode Continuous Current Rating
Diode Recommendation			BYV26C		Suggested Freewheeling Diode
OUTPUT INDUCTOR					
Core type	Off-the-Shelf		Off-the-Shelf		Select core type between Ferrite and Off-the-Shelf
Core size					Select core size
Custom Core					Enter custom core description (if used)
AE			N/A	mm^2	Core Effective Cross Sectional Area
LE			N/A	mm	Core Effective Path Length
AL			N/A	nH/T^2	Ungapped Core Effective Inductance
BW			N/A	mm	Bobbin Physical Winding Width
NL			N/A		Number of turns on inductor
BP			N/A	Gauss	Peak flux density
LG			N/A	mm	Gap length
OD			N/A		Maximum Primary Wire Diameter including insulation
INS			N/A		Estimated Total Insulation Thickness



					(= 2 * film thickness)
DIA			N/A		Bare conductor diameter
AWG			N/A		Primary Wire Gauge (Rounded to next smaller standard AWG value)
CM			N/A		Bare conductor effective area in circular mils
CMA			N/A		!!! INCREASE CMA > 200 (increase L(primary layers),decrease NS, use larger Core)
L			N/A		
LP	1350		1350	uH	Output Inductor, Recommended Standard Value
IO_Average			82.52548	mA	Average output current
ILRMS			176.4503	mA	Estimated RMS inductor current (at VMAX)
FEEDBACK COMPONENTS					
RFB	26.8		26.8	Ohms	Feedback Resistor. Use closest standard 1% value
CFB			22	uF	Feedback Capacitor
OUTPUT REGULATION					
IO_VACMIN			82.52548	mA	Output Current at VACMIN
IO_VACNOM			80.51328	mA	Output Current at VACNOM
IO_VACMAX			79.12785	mA	Output Current at VACMAX



8 Performance Data

All measurements performed at room temperature ($\approx 25\text{ }^{\circ}\text{C}$) unless otherwise specified.

Input		Input Measurement				LED Load Measurement			Efficiency (%)	Regulation (%)
VAC (V_{RMS})	Freq (Hz)	V_{IN} (V_{RMS})	I_{IN} (mA_{RMS})	P_{IN} (W)	PF	V_{OUT} (V_{DC})	I_{OUT} (mA_{DC})	P_{OUT} (W)		
190	50	190.20	54.85	7.449	0.714	81.4500	83.680	6.832	91.72	2.05
200	50	220.35	53.19	7.388	0.630	81.4400	82.620	6.740	91.23	0.76
220	50	230.22	52.27	7.332	0.609	81.4400	82.000	6.688	91.22	0.00
230	50	240.23	51.60	7.279	0.587	81.4300	81.390	6.637	91.18	-0.74
265	50	265.25	50.39	7.100	0.531	81.4000	79.050	6.442	90.73	-3.60
190	50	190.16	55.32	7.669	0.729	84.4900	83.260	7.052	91.95	1.54
200	50	220.35	52.81	7.598	0.653	84.4800	82.290	6.964	91.66	0.35
220	50	230.21	52.40	7.570	0.628	84.4800	81.840	6.925	91.48	-0.20
230	50	240.23	52.08	7.545	0.603	84.4700	81.390	6.885	91.25	-0.74
265	50	265.28	52.16	7.473	0.540	84.4600	80.300	6.790	90.86	-2.07
190	50	190.17	55.92	7.937	0.746	87.5700	83.230	7.306	92.05	1.50
200	50	220.35	53.01	7.833	0.671	87.5500	81.780	7.173	91.57	-0.27
220	50	230.22	52.54	7.798	0.645	87.5400	81.480	7.144	91.61	-0.63
230	50	240.34	52.22	7.773	0.619	87.5400	81.180	7.117	91.56	-1.00
265	50	265.26	51.80	7.719	0.562	87.5300	80.430	7.048	91.31	-1.91

Table 1 – Raw Data of Unit.



8.1 Active Mode Efficiency

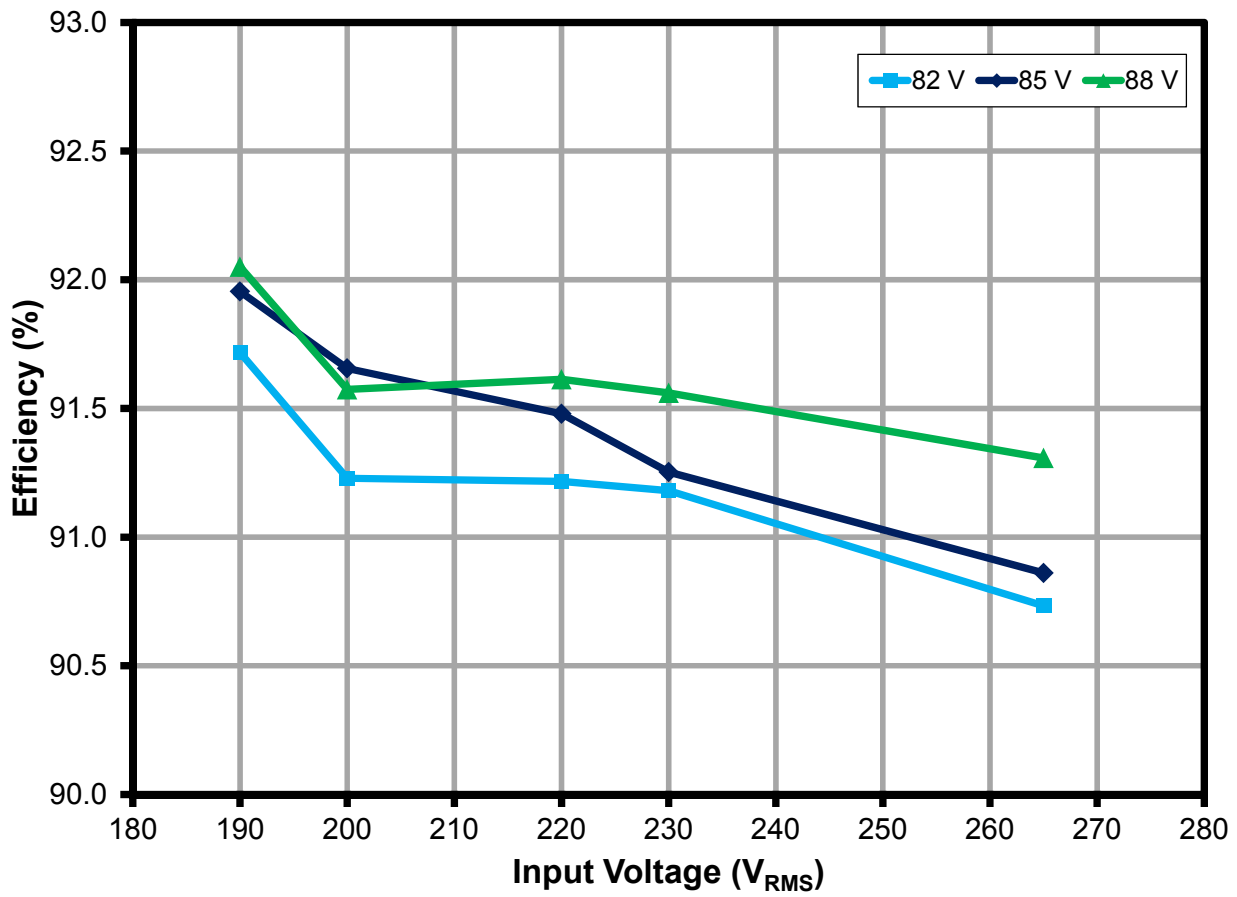

Figure 7 – Efficiency with Respect to AC Input Voltage, 190-265 VAC (60 Hz) Input.



8.2 Output Current Regulation

8.2.1 Output Current Regulation Across Line and Load

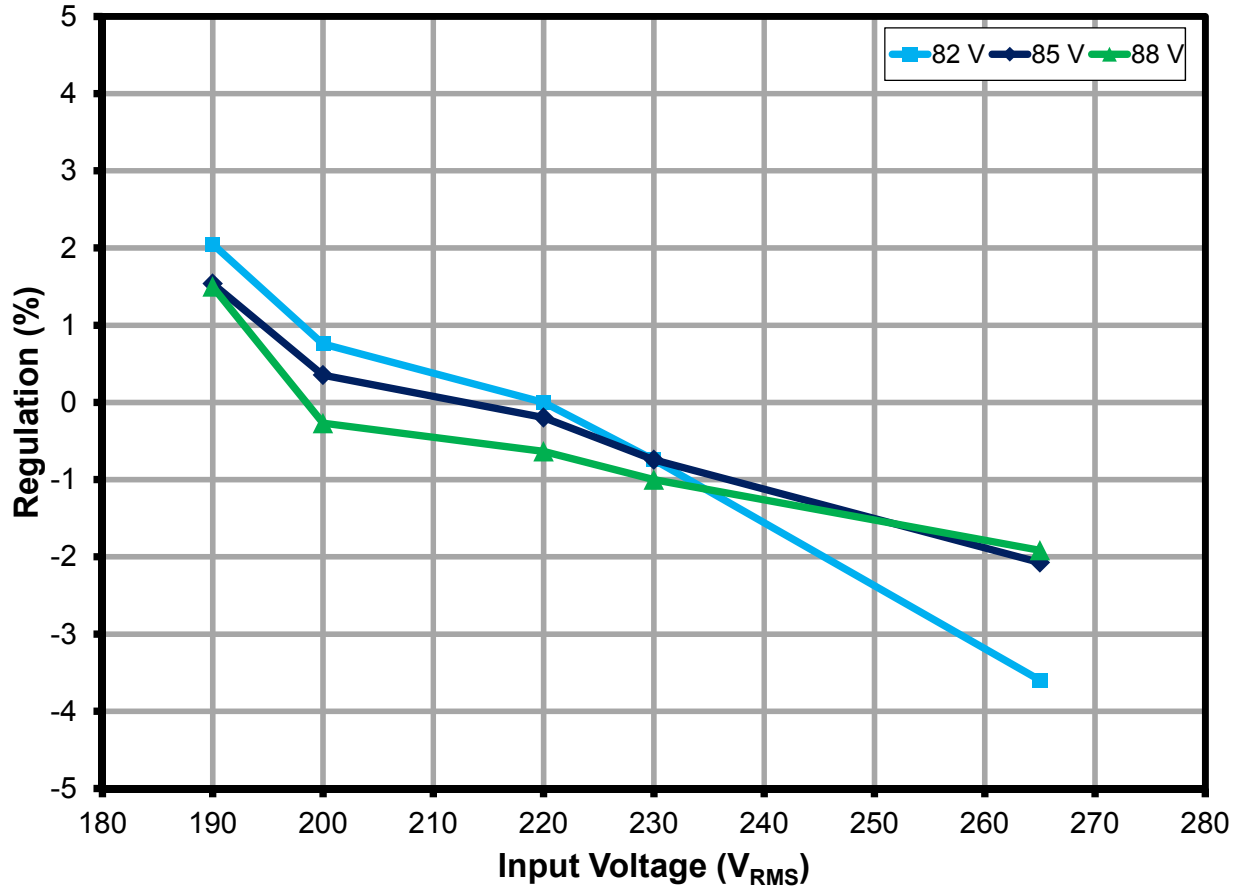

Figure 8 – Load Regulation, Room Temperature.



9 Thermal Performance

9.1 Equipment Used

Chamber:	Tenney Environmental Chamber Model No: TJR-17 942	Wattmeter:	Yokogawa Power Meter Model No: WT2000
AC Source:	Chroma Programmable AC Source Model No: 6415	Data Logger:	Agilent



Figure 9 – Thermal Chamber Set-up Showing Box Used to Prevent Airflow Over UUT. Open Frame Set-up Measurement.

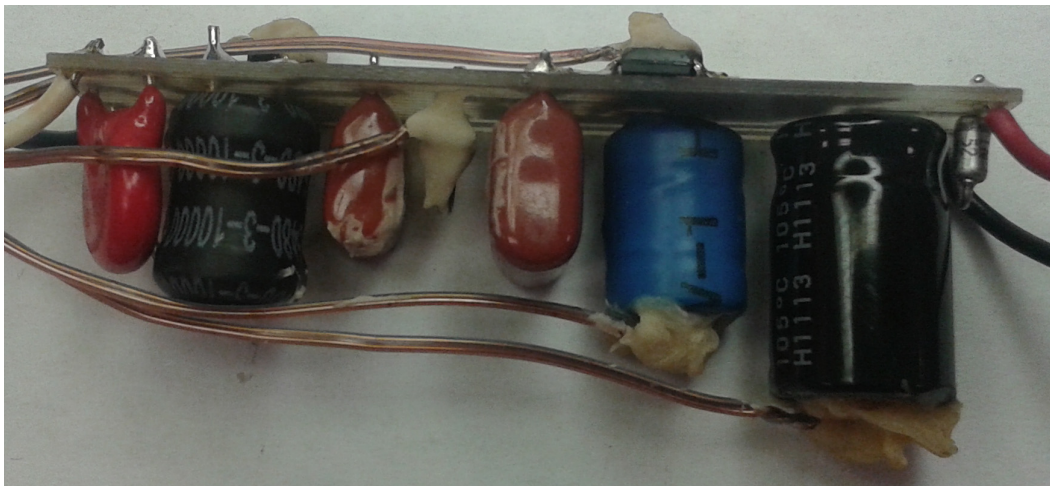

Figure 10 – Thermal Measurement, Thermocouple Set-up.



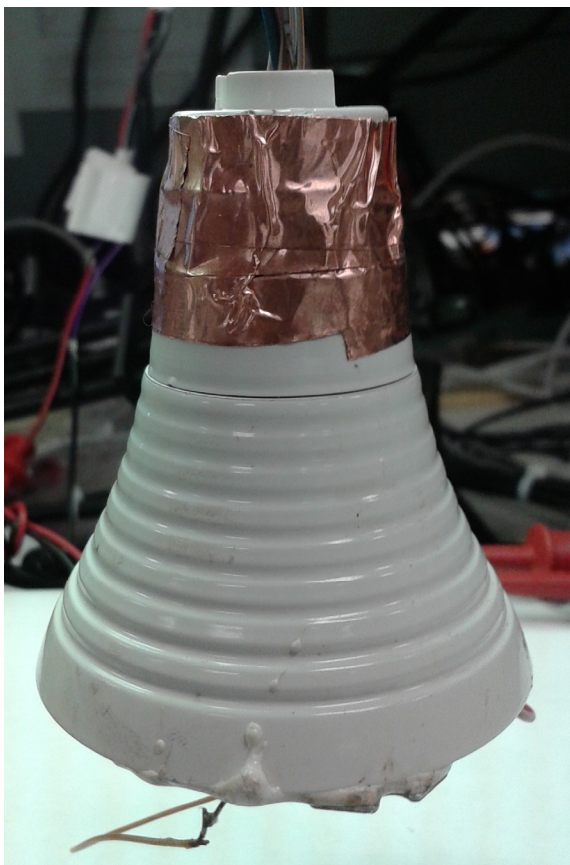

Figure 11 – Enclosed Thermal Measurement Set-up.

Note: Typical A19 enclosure is used in the test; the housing may be identical to lamps available in the market but it does not limit its application. It is up to the end customer to enclose the driver and design the housing.



9.2 Thermal Result

9.2.1 Load: 85 V / 82 m A LED Load.

Remarks	Internal Ambient °C	BR °C	LYT0006D °C	L2;Power Inductor °C	Output Capacitor °C	Output Diode °C
Normal Operation Open Frame in the Thermal Chamber 190 V / 50 Hz	-10	-5.77	4.91	-2.24	-10.24	-0.15
	0	3.92	14.36	6.81	-0.98	9.28
	10	13.39	23.80	15.71	8.23	18.29
	20	23.10	33.37	25.10	17.89	28.07
	30	32.95	43.09	34.45	27.58	37.70
	40	42.64	52.69	43.71	37.16	47.12
	50	52.30	62.33	53.12	46.80	56.79
	60	61.92	71.65	61.98	55.77	66.10
	70	71.69	81.40	71.32	65.44	75.87
	80	81.52	91.33	80.89	75.19	85.60
	90	91.01	101.09	90.23	85.05	95.59
	100	101.31	110.97	99.85	94.78	105.34
110	111.48	121.03	109.71	105.11	115.51	
OTP; 190 V / 50 Hz	117	119.28	129.15	117.55	112.42	123.19
Recovery; 190 V / 50 Hz	53	58.08	62.83	65.18	61.33	61.86
190 V / 50 Hz Enclosed (30 °C External Ambient)	64	54.28	78.39	74.10	70.15	67.79
265 V / 50 Hz Enclosed (30 °C External Ambient)	65	54.30	81.11	76.26	71.11	69.66

Table 2 – Thermal Measurement.



9.3 Thermal Scan

Open-frame thermal measurement at 25°C ambient. UUT was soaked for 1 hour to achieve steady-state before the measurements were made.

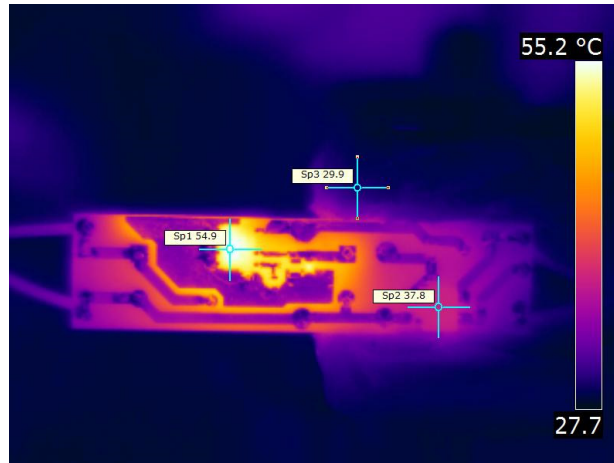

Figure 12 – Temperature (°C) at Bottom Side of PCB.
 SP1 – U1, LYT0006D.
 SP2 – BR1, Bridge Rectifier.
 SP3 – Ambient.

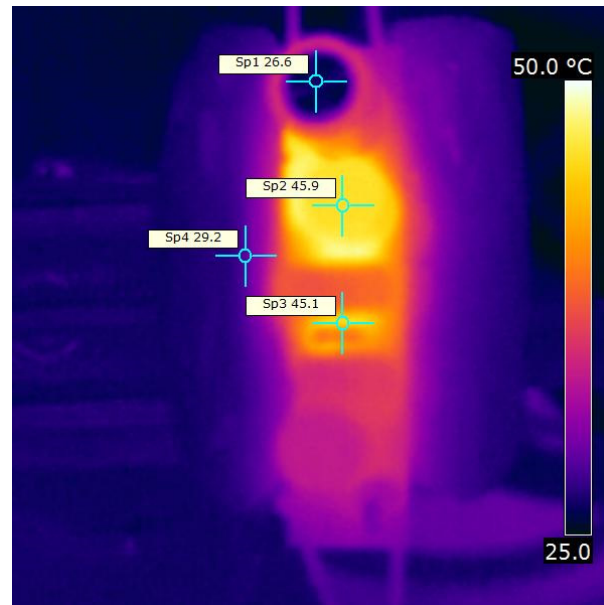

Figure 13 – Temperature (°C) at Top Side of PCB.
 SP1 – Output Capacitor.
 SP2 – L2, Power inductor.
 SP3 – D1, Freewheeling Diode.
 SP4 – Ambient.



10 Waveforms

10.1 Drain Voltage, Current Normal Operation

Missing pulses are normal and are used to regulate the output current. These missing pulses are present every time the sense resistors (R2, R3) voltage-drop reaches 1.65 V. The unit will enter into auto-restart if there is not at least one missing pulse within a 50 ms period. For some designs where the power inductance is high and the circuit is operating (mostly) in CCM, a period of reverse current may be present. This can be avoided by increasing the device size or increase input capacitance or adding a drain blocking diode. See AN-60 for additional information.

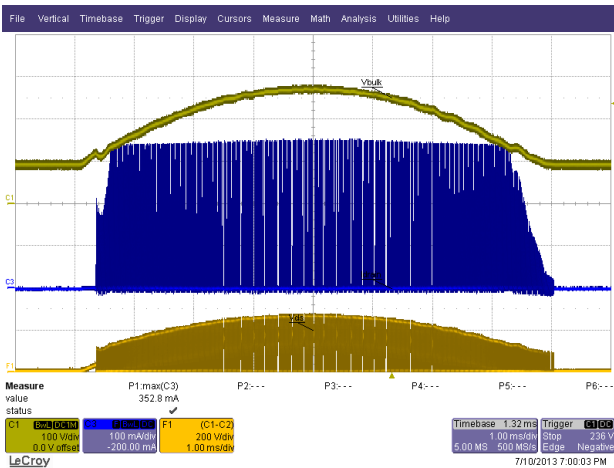

Figure 14 – 190 VAC, 50 Hz, Nominal V_{LED} Load.
 F1 (Orange): V_{D-S} , 200 V / div.
 Ch1 (Yellow): V_{D-G} , 100 V / div.
 Ch3 (Blue): I_{DRAIN} , 100 mA / div.
 Time Scale: 1 ms / div.

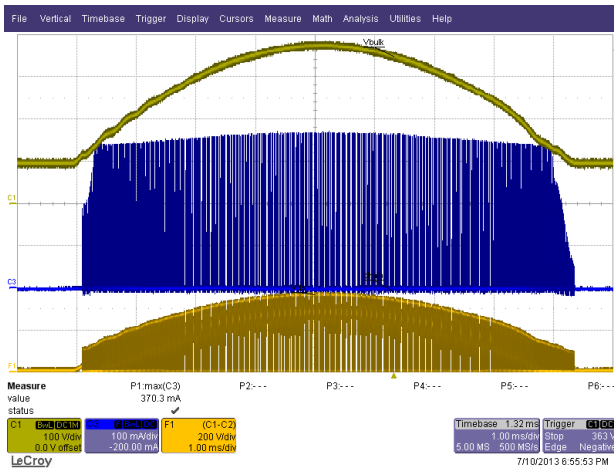

Figure 15 – 265 VAC, 50 Hz, Nominal V_{LED} Load.
 F1 (Orange): V_{D-S} , 200 V / div.
 Ch1 (Yellow): V_{D-G} , 100 V / div.
 Ch3 (Blue): I_{DRAIN} , 100 mA / div.
 Time Scale: 1 ms / div.

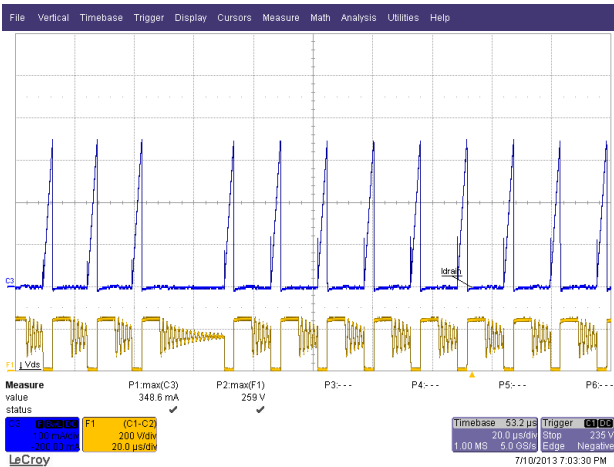

Figure 16 – 190 VAC, 50 Hz, Nominal V_{LED} Load.
 F1 (Orange): V_{D-S} , 200 V / div. Ch3 (Blue): I_{DRAIN} , 100 mA / div.
 Time Scale: 20 μ s / div.

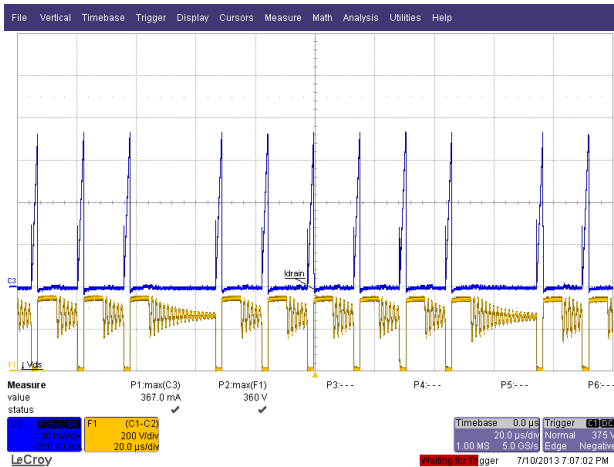

Figure 17 – 265 VAC, 50 Hz, Nominal V_{LED} Load.
 F1 (Orange): V_{D-S} , 200 V / div. Ch3 (Blue): I_{DRAIN} , 100 mA / div.
 Time Scale: 20 μ s / div.

10.2 Drain Voltage and Current When Output Short

Device is operating within range, no inductor saturation was observed.

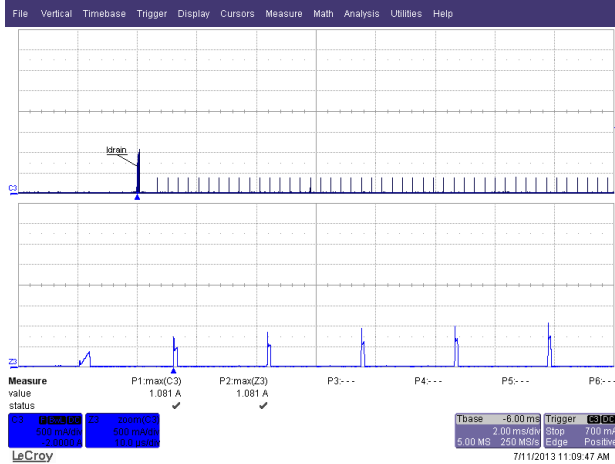

Figure 18 – LYT0006D Output Short. 265 VAC.
 Ch3: I_{DRAIN} , 0.5 A / div.
 Time Scale: 2 ms / div.
 Z4: V_{D-S} , 0.5 A / div.
 Zoom Time Scale: 10 μ s / div.

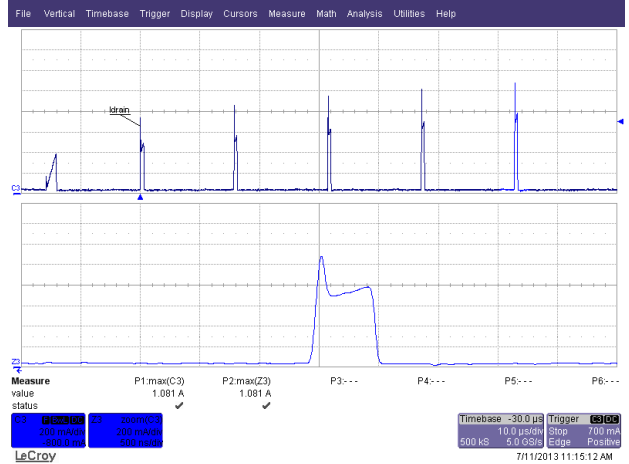

Figure 19 – LYT0006D Output Short. 265 VAC.
 Ch4: I_{DRAIN} , 0.2 A / div.
 Time Scale: 10 μ s / div.
 Z4: V_{D-S} , 0.2 A / div.
 Zoom Time Scale: 500 ns / div.

10.3 Drain Voltage and Current Start-up Profile

Device is operating within range, no inductor saturation was observed.

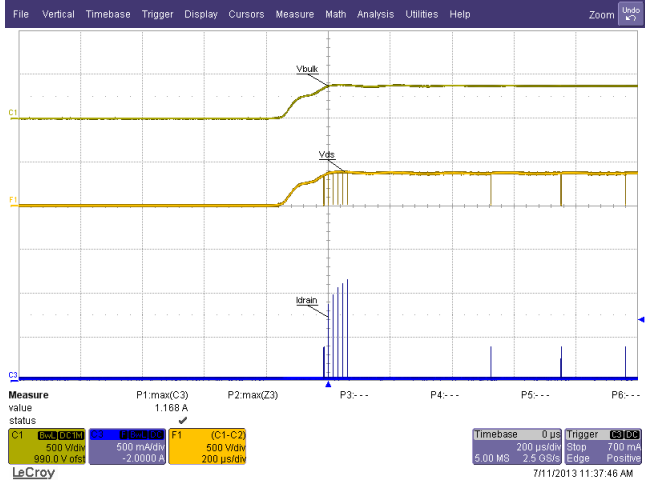

Figure 20 – 265 VAC / 50 Hz Start-up.
 Ch1: Bulk Input, 500 V / div.
 Ch3: Z4: I_{DRAIN} , 0.5 A / div.
 Time Scale: 200 μ s / div.
 F1: V_{D-S} , 500 V / div.
 Zoom Time Scale: 200 μ s / div.

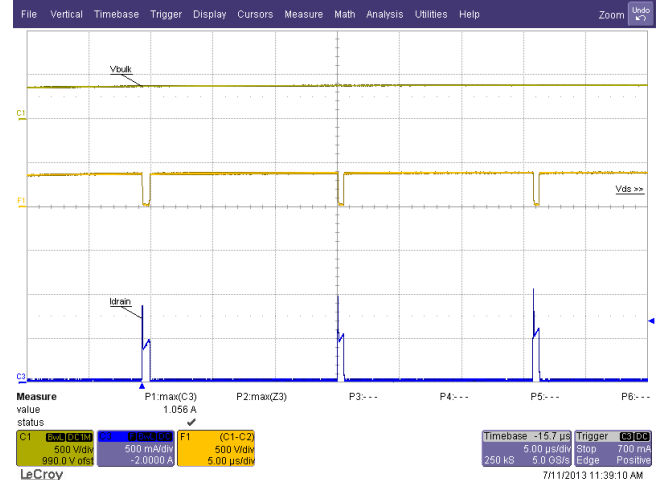

Figure 21 – 265 VAC / 50 Hz Start-up.
 Ch1: Bulk Input, 500 V / div.
 Ch3: Z4: I_{DRAIN} , 0.5 A / div.
 Time Scale: 200 μ s / div.
 F1: V_{D-S} , 500 V / div.
 Zoom Time Scale: 200 μ s / div.



10.4 Output Current Start-up Profile

Output current/light is present within one AC cycle (<100 ms).

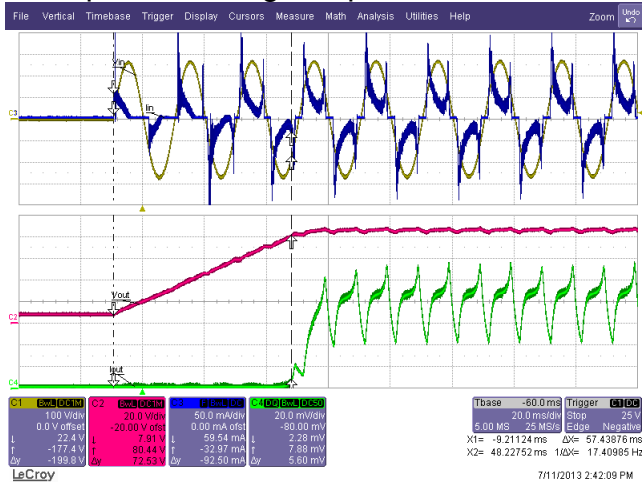

Figure 22 – 190 VAC, 50 Hz, Nominal V_{LED} Load.

Ch1 (Yellow): V_{IN} , 100 V / div.
 Ch2 (Red): V_{OUT} , 20 V.
 Ch3 (Blue): I_{IN} , 50 mA / div.
 Ch4 (Green): I_{OUT} , 20 mA / div, 20 ms / div.

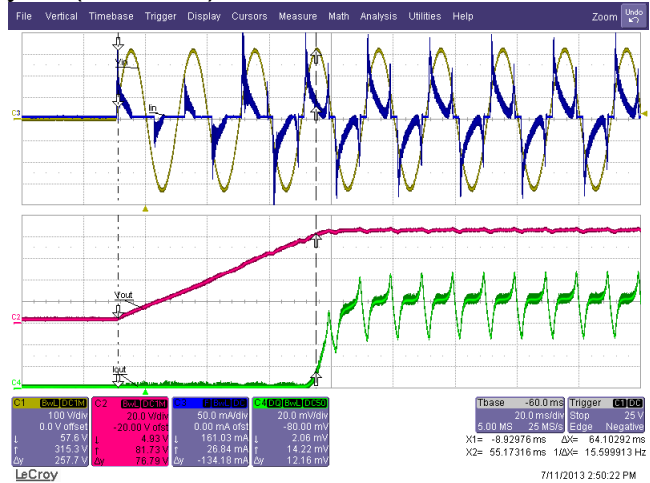

Figure 23 – 230 VAC, 50 Hz, Nominal V_{LED} Load.

Ch1 (Yellow): V_{IN} , 100 V / div.
 Ch2 (Red): V_{OUT} , 20 V.
 Ch3 (Blue): I_{IN} , 50 mA / div.
 Ch4 (Green): I_{OUT} , 20 mA / div, 20 ms / div.

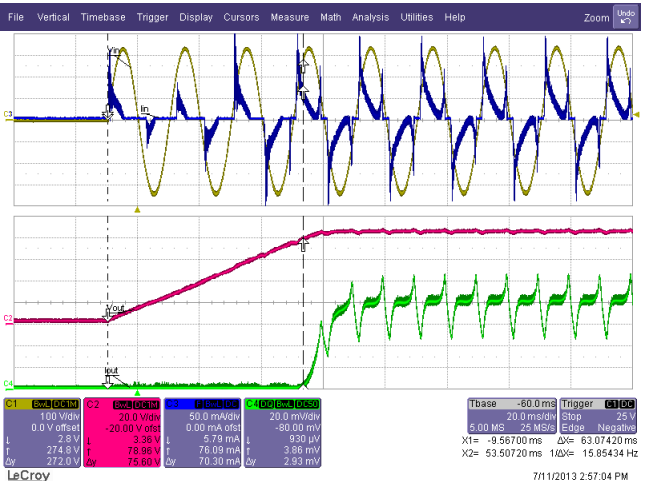

Figure 24 – 240 VAC, 50 Hz, Nominal V_{LED} Load.

Ch1 (Yellow): V_{IN} , 100 V / div.
 Ch2 (Red): V_{OUT} , 20 V.
 Ch3 (Blue): I_{IN} , 50 mA / div.
 Ch4 (Green): I_{OUT} , 20 mA / div, 20 ms / div.

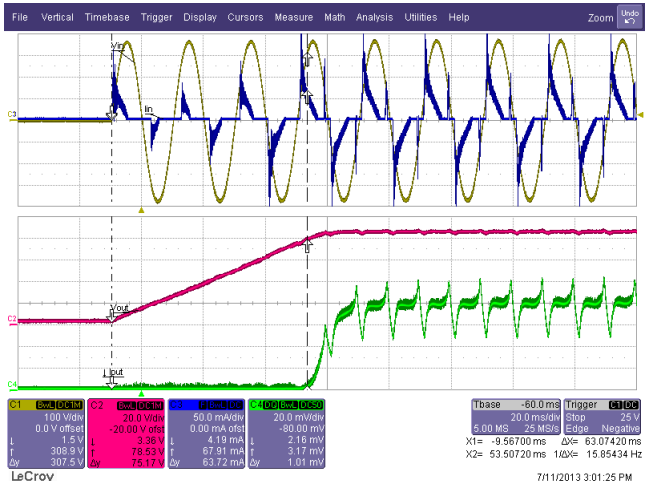

Figure 25 – 265 VAC, 50 Hz, Nominal V_{LED} Load.

Ch1 (Yellow): V_{IN} , 100 V / div.
 Ch2 (Red): V_{OUT} , 20 V.
 Ch3 (Blue): I_{IN} , 50 mA / div.
 Ch4 (Green): I_{OUT} , 20 mA / div, 20 ms / div.



10.5 Input-Output Profile

There is no limitation to the amount of output capacitance that can be added. If the application requires less output current ripple then increasing the output capacitance is straightforward. Note that the output current waveform below will change depending on LED load impedance which varies according to LED type.

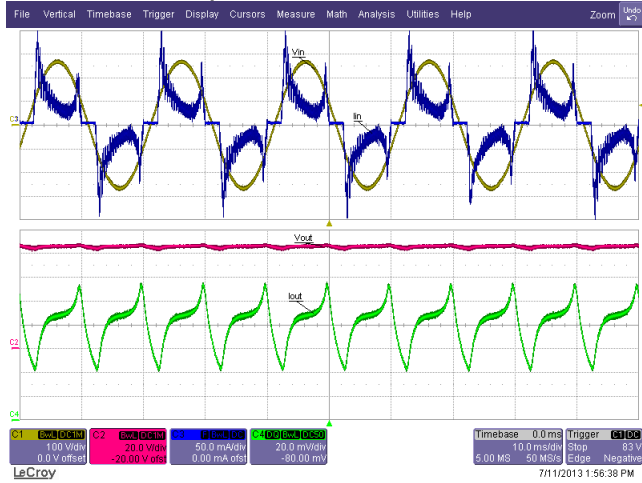

Figure 26 – 190 VAC / 50 Hz, Nominal V_{LED} Load.
 Ch1 (Yellow): V_{IN} , 100 V / div.
 Ch2 (Red): V_{OUT} , 20 V.
 Ch3 (Blue): I_{IN} , 50 mA / div.
 Ch4 (Green): I_{OUT} , 20 mA / div, 10 ms / div.

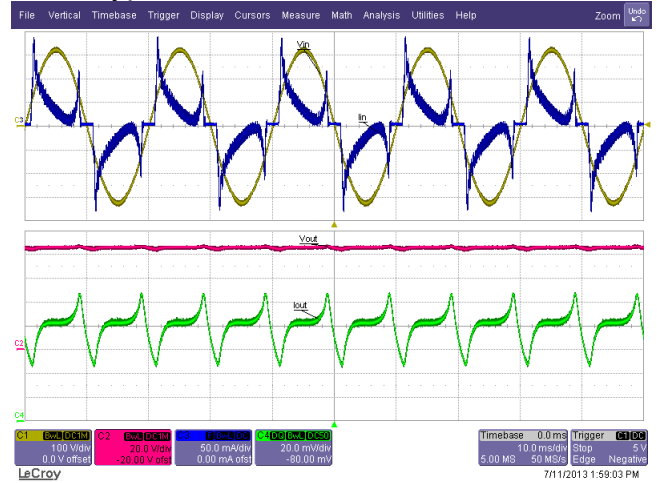

Figure 27 – 230 VAC / 50 Hz, Nominal V_{LED} Load.
 Ch1 (Yellow): V_{IN} , 100 V / div.
 Ch2 (Red): V_{OUT} , 20 V.
 Ch3 (Blue): I_{IN} , 50 mA / div.
 Ch4 (Green): I_{OUT} , 20 mA / div, 10 ms / div.

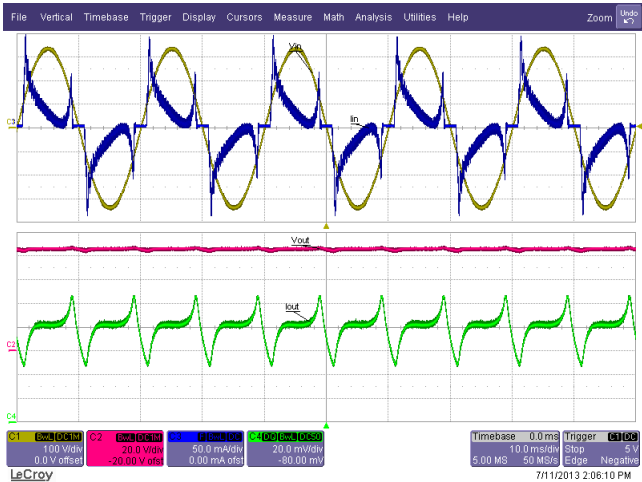

Figure 28 – 240 VAC / 50 Hz, Nominal V_{LED} Load.
 Ch1 (Yellow): V_{IN} , 100 V / div.
 Ch2 (Red): V_{OUT} , 20 V.
 Ch3 (Blue): I_{IN} , 50 mA / div.
 Ch4 (Green): I_{OUT} , 20 mA / div, 10 ms / div.

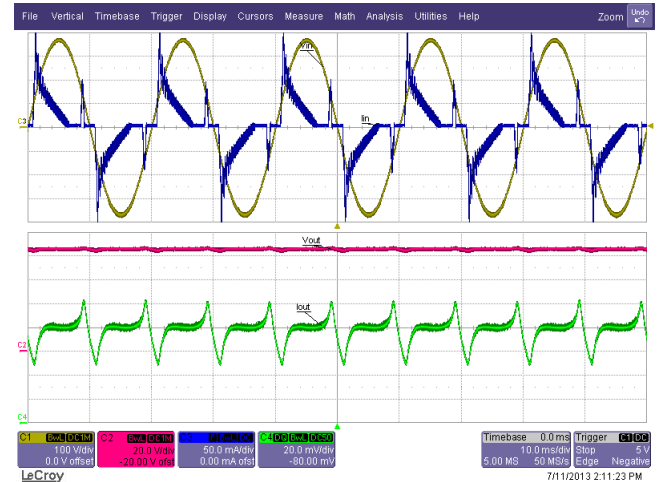

Figure 29 – 265 VAC / 50 Hz, Nominal V_{LED} Load.
 Ch1 (Yellow): V_{IN} , 100 V / div.
 Ch2 (Red): V_{OUT} , 20 V.
 Ch3 (Blue): I_{IN} , 50 mA / div.
 Ch4 (Green): I_{OUT} , 20 mA / div, 10 ms / div.



10.6 Line Sag and Surge

An inherent advantage of the buck converter implemented with the LYTSwitch-0 family is the imperceptible start-up delay, the driver will turn-on within 100 ms as shown below. No failure of any component occurred during line fluctuation tests.

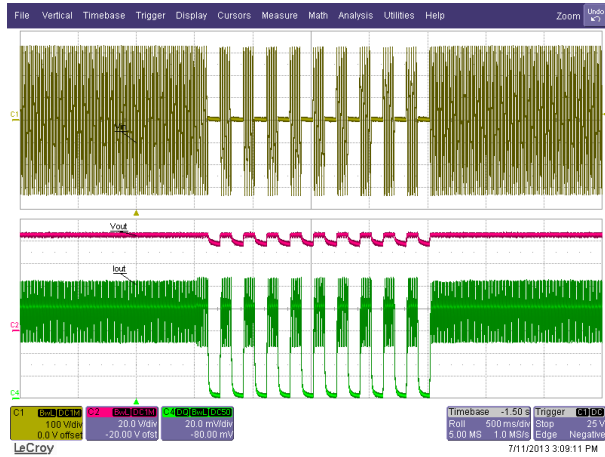

Figure 30 – Line Sag Test at 230 - 0 V at 0.1 Second Interval.
 Ch1: V_{IN} , 100 V / div.
 Ch2: V_{OUT} , 20 V / div.
 Ch4: I_{OUT} , 50 mA / div.
 Time Scale: 500 ms / div.

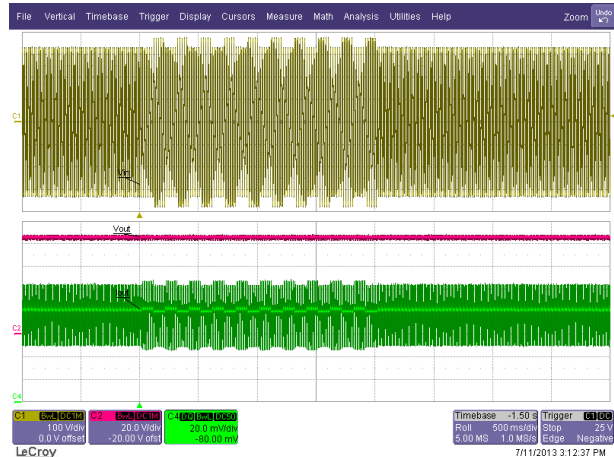

Figure 31 – Line Surge Test at 230 - 265 V at 0.1 Second Interval.
 Ch1: V_{IN} , 100 V / div.
 Ch2: V_{OUT} , 20 V / div.
 Ch4: I_{OUT} , 50 mA / div.
 Time Scale: 500 ms / div.

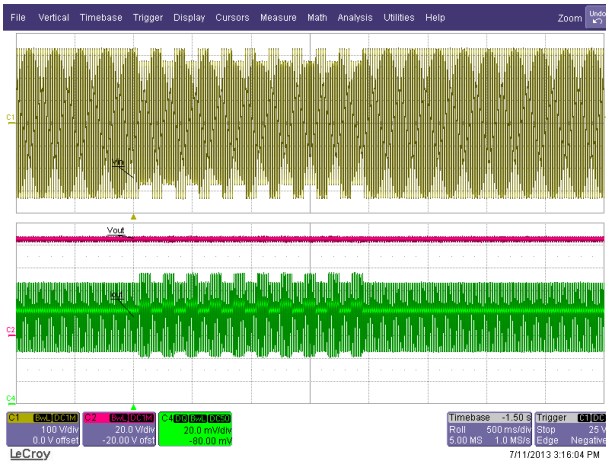

Figure 32 – Line Surge Test at 230 - 190 V at 0.1 Second Interval.
 Ch1: V_{IN} , 100 V / div.
 Ch2: V_{OUT} , 20 V / div.
 Ch4: I_{OUT} , 50 mA / div.
 Time Scale: 500 ms / div.

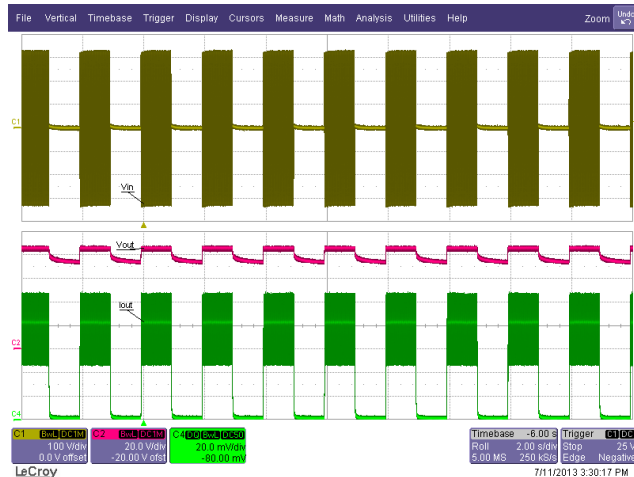

Figure 33 – Line Sag Test at 230 - 0 V at 1 Second Interval.
 Ch1: V_{IN} , 100 V / div.
 Ch2: V_{OUT} , 20 V / div.
 Ch4: I_{OUT} , 50 mA / div.
 Time Scale: 2 s / div.



10.7 One Shot No-Load Protection

The reference design is protected with one shot no-load protection. Zener diode VR1 will need to be replaced after the fault.

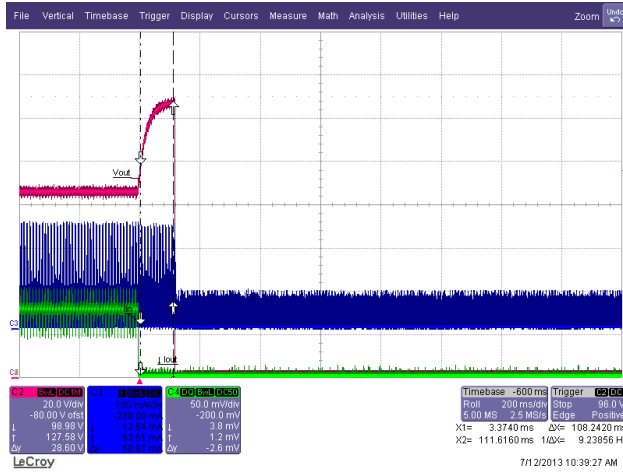

Figure 34 – No-Load Protection When Load is Disconnected. 265 V / 50 Hz.
 Ch2: V_{OUT} , 20 V / div.
 Ch3: I_{DRAIN} , 100 mA / div.
 Ch3: I_{OUT} , 50 mA / div.
 Time Scale: 200 ms / div.

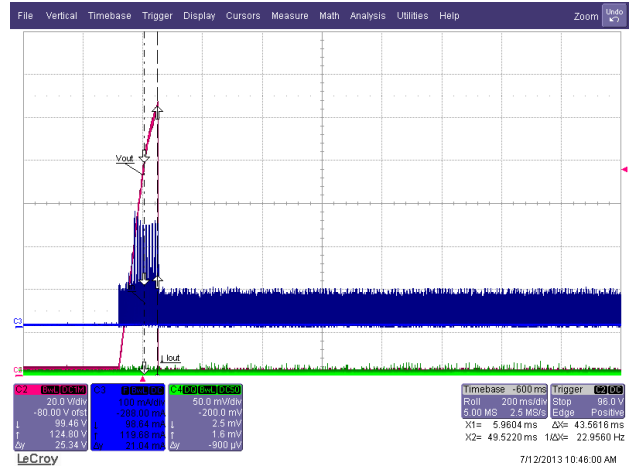

Figure 35 – No-Load Start-Up. 265 V / 50 Hz.
 Ch2: V_{OUT} , 20 V / div.
 Ch3: I_{DRAIN} , 100 mA / div.
 Ch3: I_{OUT} , 50 mA / div.
 Time Scale: 200 ms / div.



10.8 Brown-out / Brown-in

No failure of any component during brownout test of 1 V / sec and 10 V / sec AC cut-in and cut-off. Consider the peak current at 132 mApk with an average of 75 mA_{AVG} during brown-out for LED absolute maximum rating.

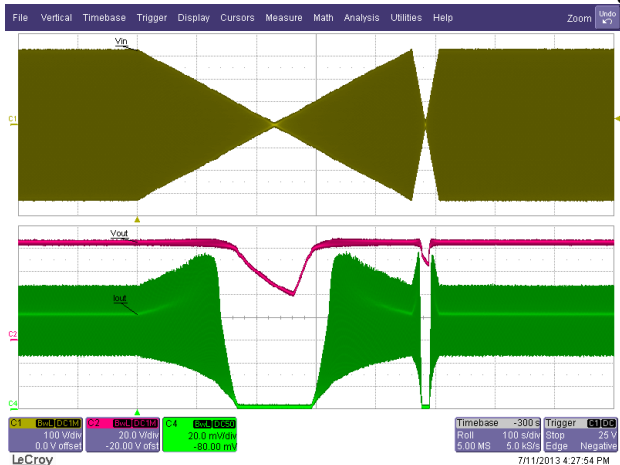

Figure 36 – Brown-out Test at 1 V / s and 10 V / s.
 The Unit is Able to Operate Normally
 Without Any Failure and Without Flicker.
 230 V - 0 - 230 V
 Ch1: V_{IN}, 100 V / div.
 Ch1: V_{OUT}, 20 V / div.
 Ch3: I_{OUT}, 20 mA / div.
 Time Scale: 100 s / div.

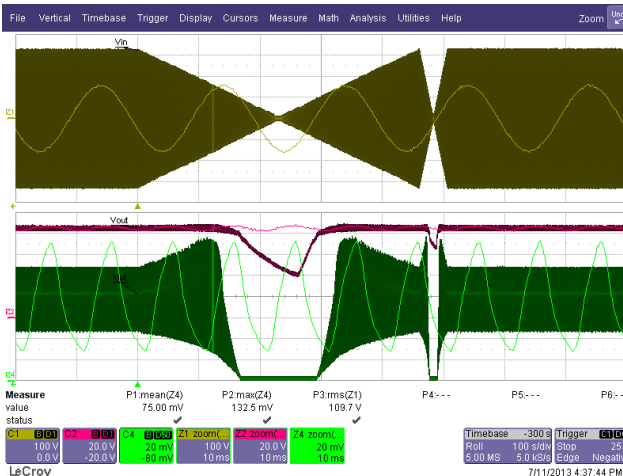

Figure 37 – Brown-out Test at 1 V / s and 10 V / s.
 The Unit is Able to Operate Normally
 Without Any Failure and Without
 Flicker. 230 V - 0 - 230 V
 Ch1: V_{IN}, 100 V / div.
 Ch1: V_{OUT}, 20 V / div.
 Ch3: I_{OUT}, 20 mA / div.
 Time Scale: 100 s / div.



11 Line Surge

Differential input line 500V / 50 μ s surge testing was completed on a single test unit following the test method described in IEC61000-4-5. Input voltage was set at 230 VAC / 60 Hz. Full output load applied and operation was verified following each surge event.

Surge Level (V)	Input Voltage (VAC)	Injection Location	Injection Phase (°)	Test Result (Pass/Fail)
+500	230	L to N	90	Pass
-500	230	L to N	90	Pass
+500	230	L to N	270	Pass
-500	230	L to N	270	Pass
+500	230	L to N	0	Pass
-500	230	L to N	0	Pass

Unit passed testing under all conditions.

Differential ring input line surge testing was completed on a single test unit following the test method described in IEC61000-4-5. Input voltage was set at 230 VAC / 60 Hz. Full output load was applied and operation was verified following each surge event.

Surge Level (V)	Input Voltage (VAC)	Injection Location	Injection Phase (°)	Test Result (Pass/Fail)
+2500	230	L to N	90	Pass
-2500	230	L to N	90	Pass
+2500	230	L to N	270	Pass
-2500	230	L to N	270	Pass
+2500	230	L to N	0	Pass
-2500	230	L to N	0	Pass

Unit passed testing under all conditions.



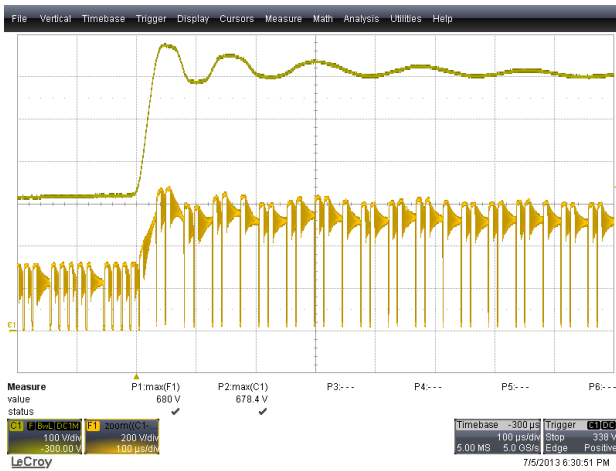

Figure 38 – Differential Line Surge at 500 V / 90°. Peak Drain Voltage Recorded is 680 V.
 Ch1: V_{BULK} , 100 V / div.
 F1: V_{DRAIN} , 200 V / div.
 Time Scale: 100 μ s / div.

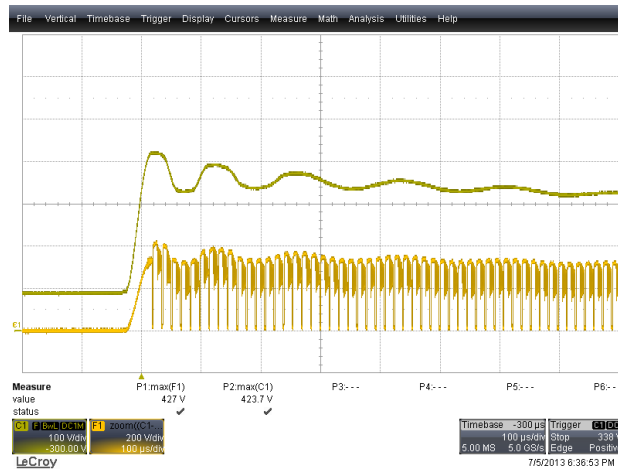

Figure 39 – Differential Line Surge at 500 V / 90°. Peak Drain Voltage Recorded is 427 V.
 Ch1: V_{BULK} , 100 V / div.
 F1: V_{DRAIN} , 200 V / div.
 Time Scale: 100 μ s / div.

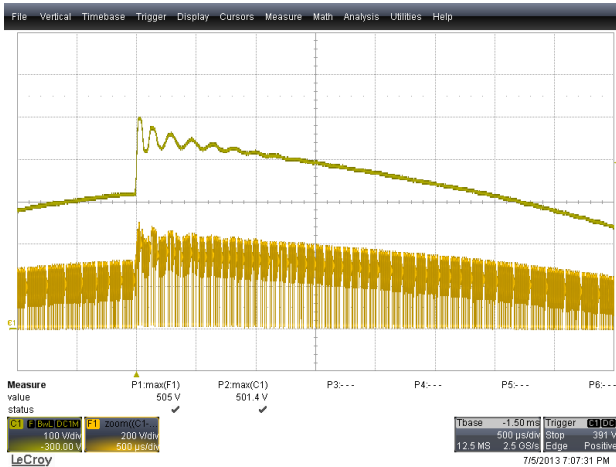

Figure 40 – Differential Ring Surge at 2500 V / 90°. Peak Drain Voltage Recorded is 505 V.
 Ch1: V_{BULK} , 100 V / div.
 F1: V_{DRAIN} , 200 V / div.
 Time Scale: 500 μ s / div.

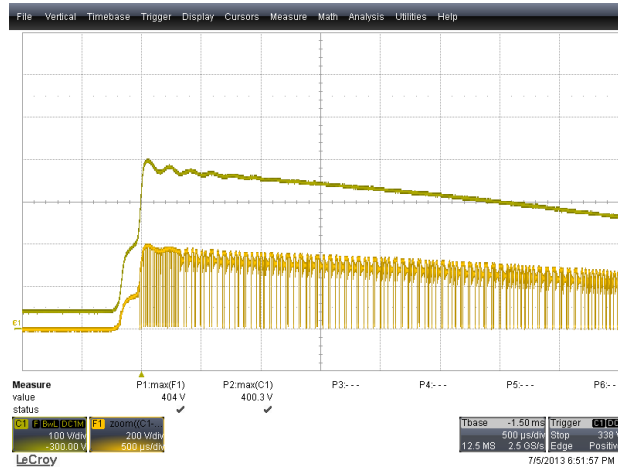

Figure 41 – Differential Ring Surge at 2500 V / 0°. Peak Drain Voltage Recorded is 404 V.
 Ch1: V_{BULK} , 100 V / div.
 F1: V_{DRAIN} , 200 V / div.
 Time Scale: 500 μ s / div.



12 Conducted EMI

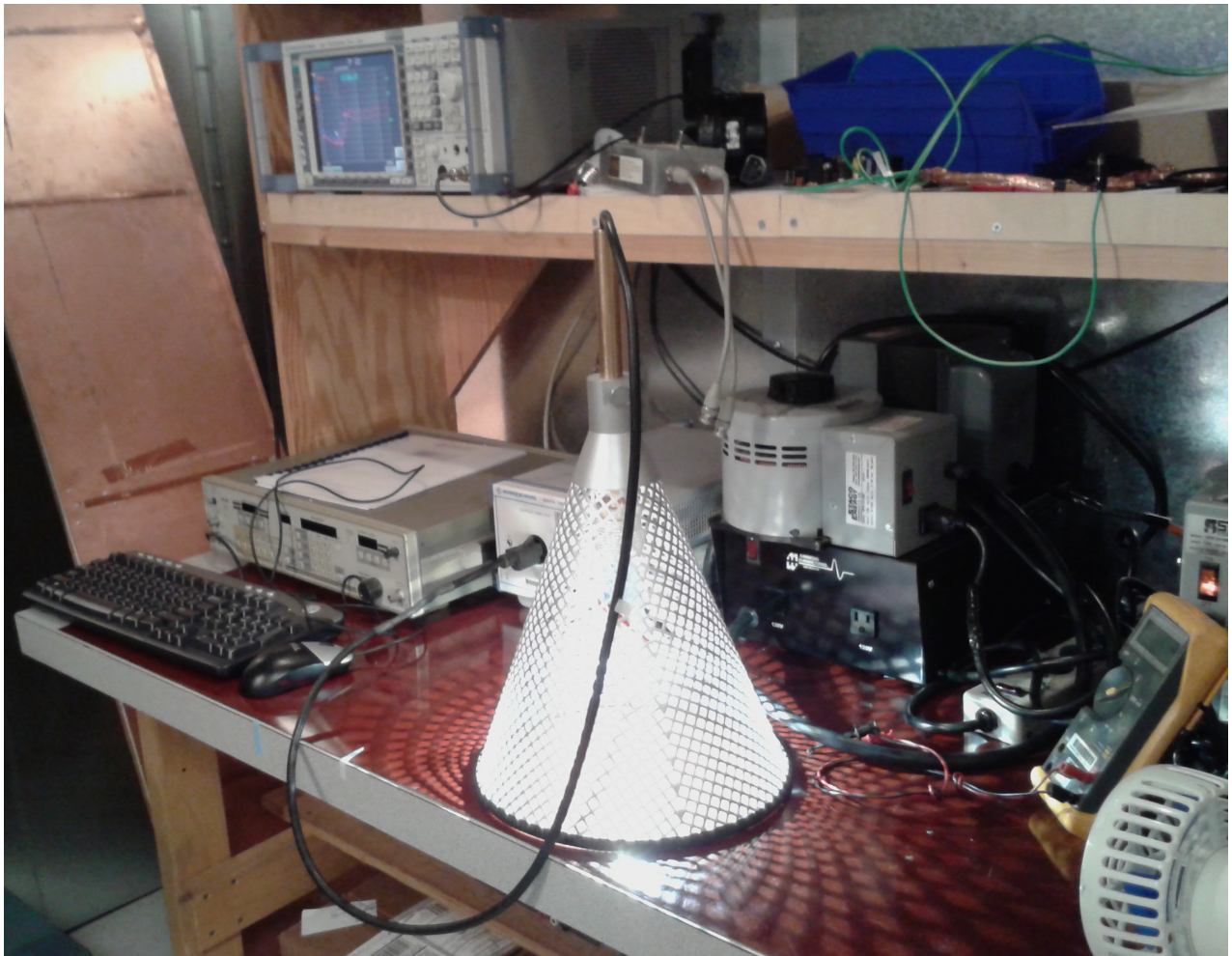

Figure 42 – The Retrofit Lamp was Verified Inside a Conical Metal Cone as per EN55015.





Power Integrations
03.Jul 13 21:00

RBW 9 kHz
MT 500 ms

Att 10 dB AUTO

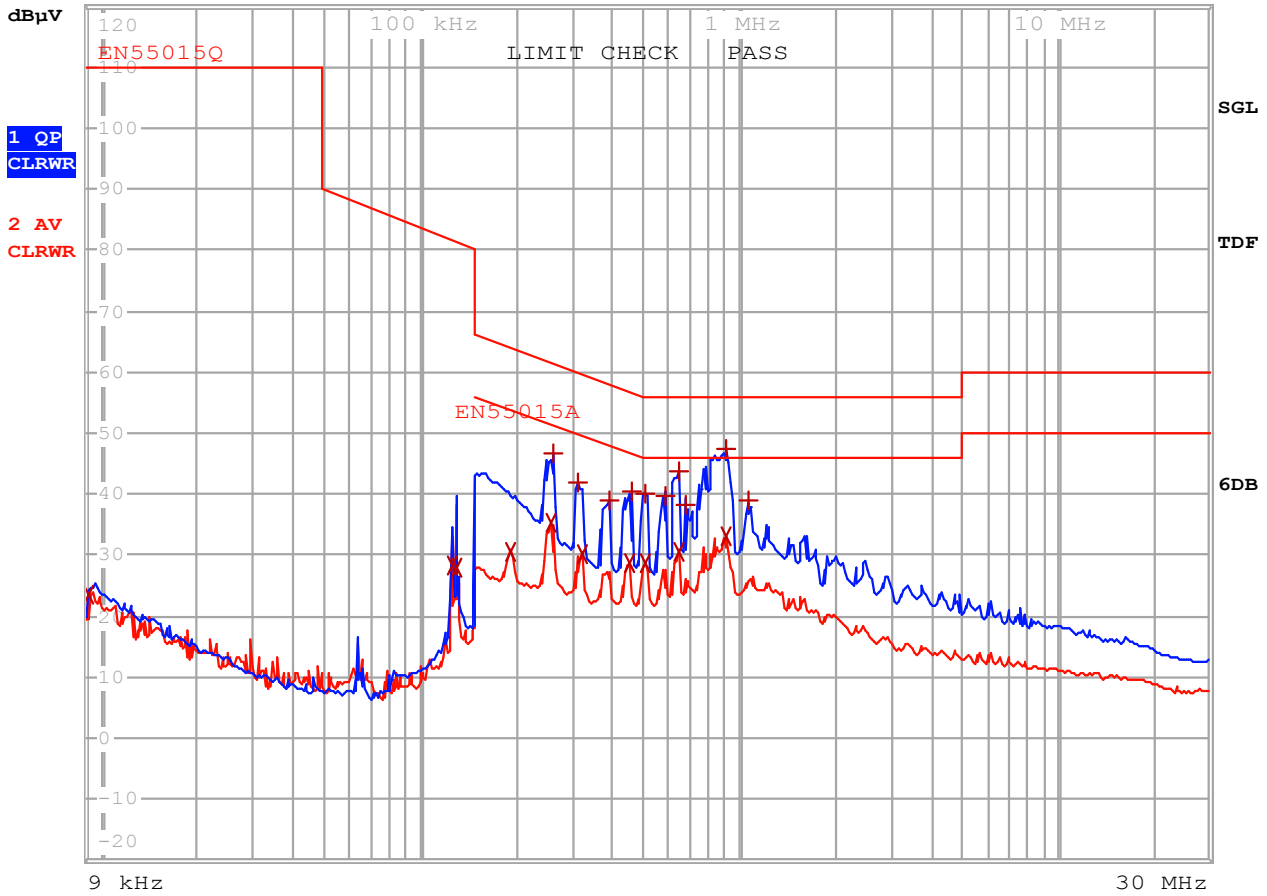

Figure 43 – Conducted EMI, Maximum Steady State Load, 230 VAC, 60 Hz, and EN55015 B Limits. Enclosed Unit in a Typical A19 Bulb Replacement Housing.



Trace1: EN55015Q
 Trace2: EN55015A
 Trace3: ---

	TRACE	FREQUENCY	LEVEL dB μ V	DELTA LIMIT dB
2	Average	9.09 kHz	23.57 N gnd	
2	Average	125.720633819 kHz	28.32 N gnd	
2	Average	129.530094744 kHz	27.83 L1 gnd	
2	Average	192.364799253 kHz	30.64 L1 gnd	-23.29
2	Average	256.711570318 kHz	35.38 N gnd	-16.15
1	Quasi Peak	259.278686021 kHz	46.59 L1 gnd	-14.85
1	Quasi Peak	310.135545783 kHz	42.05 L1 gnd	-17.90
2	Average	322.728292586 kHz	30.28 N gnd	-19.35
1	Quasi Peak	389.890938834 kHz	39.15 L1 gnd	-18.90
2	Average	452.651275966 kHz	28.63 N gnd	-18.19
1	Quasi Peak	457.177788726 kHz	40.31 N gnd	-16.42
1	Quasi Peak	505.008700673 kHz	40.18 L1 gnd	-15.81
2	Average	510.05878768 kHz	28.59 N gnd	-17.40
1	Quasi Peak	586.299423673 kHz	39.77 L1 gnd	-16.22
1	Quasi Peak	647.639315505 kHz	43.74 L1 gnd	-12.25
2	Average	647.639315505 kHz	30.70 N gnd	-15.29
1	Quasi Peak	680.675429436 kHz	38.42 L1 gnd	-17.57
1	Quasi Peak	908.363999266 kHz	47.31 L1 gnd	-8.68
2	Average	908.363999266 kHz	33.01 N gnd	-12.98
1	Quasi Peak	1.06512822736 MHz	39.04 L1 gnd	-16.95

Table 3 – Conducted EMI, Maximum Steady State Load, 230 VAC, 60 Hz, and EN55015 B Limits. Enclosed Unit in a Typical A19 Bulb Replacement Housing.



13 Revision History

Date	Author	Revision	Description & changes	Reviewed
04-Oct-13	JDC	1.0	Initial Release	Apps & Mktg

