



<b>Title</b>	<b><i>Reference Design Kit for a Low Standby Current Non-Isolated Flyback Power Supply Using LinkSwitch™-TN2 LNK3202D</i></b>
<b>Specification</b>	85 VAC – 277 VAC Input; 3.8 V / 20 mA and 12 V / 20 mA Outputs
<b>Application</b>	Home and Building Automation
<b>Author</b>	Applications Engineering Department
<b>Document Number</b>	RDR-623
<b>Date</b>	May 24, 2018
<b>Revision</b>	1.4

#### **Summary and Features**

- Highly integrated solution with LNK3202D
- Low component count with integrated 725 V MOSFET, current sensing and protection
- Wide range AC input
- <65  $\mu$ A standby input current across AC line
- Two outputs, 3.8 V ( $\pm$ 5%) and 12 V ( $\pm$ 10%)
- <7 mW no-load input power at 115 VAC
- <12 mW no-load input power at 230 VAC
- Load short-circuit protection
- EN55022B conducted EMI compliant

#### **PATENT INFORMATION**

The products and applications illustrated herein (including transformer construction and circuits external to the products) may be covered by one or more U.S. and foreign patents, or potentially by pending U.S. and foreign patent applications assigned to Power Integrations. A complete list of Power Integrations' patents may be found at [www.powerint.com](http://www.powerint.com). Power Integrations grants its customers a license under certain patent rights as set forth at <http://www.powerint.com/ip.htm>.

---

#### **Power Integrations**

5245 Hellyer Avenue, San Jose, CA 95138 USA.  
Tel: +1 408 414 9200 Fax: +1 408 414 9201  
[www.power.com](http://www.power.com)

## Table of Contents

1	Introduction .....	4
2	Power Supply Specification .....	5
3	Schematic .....	6
4	Circuit Description .....	7
4.1	Input Rectifier, Protection and EMI Filtering .....	7
4.2	LinkSwitch-TN2 Primary Side and Main Output Circuit Operation .....	7
4.3	Regulation of Slave Output.....	7
4.4	Output Side and Feedback Loop .....	7
5	PCB Layout .....	9
6	Bill of Materials .....	10
7	Transformer Specification .....	11
7.1	Electrical Diagram.....	11
7.2	Electrical Specifications .....	11
7.3	Material List .....	11
7.4	Transformer Build Diagram .....	12
7.5	Transformer Instructions.....	12
7.6	Transformer Winding Illustrations.....	13
8	Transformer Design Spreadsheet .....	17
9	Performance Data .....	20
9.1	Full Load Efficiency vs. Input Line Voltage.....	20
9.1.1	Efficiency vs. Line Voltage, 0.3 W (20 mA on 12 V, 20 mA on 3.8 V) .....	20
9.2	No-Load Input Power .....	21
9.3	Various Load Current vs. Input Line Voltage.....	22
9.4	Input Current at Standby vs. Input Line Voltage .....	23
9.5	Line and Load Regulation .....	24
9.5.1	12 V Line Regulation at 0.3 W (20 mA on 12 V, 20 mA on 5 V).....	24
9.5.2	3.8 V Line Regulation at 0.3 W (20 mA on 12 V, 20 mA on 3.8 V) .....	25
9.5.3	3.8 V Regulation with Varying Load (12 V Unloaded).....	26
10	Thermal Performance .....	27
10.1	Open Case .....	27
10.2	85 VAC at Room Temperature .....	27
10.3	265 VAC at Room Temperature .....	29
11	Waveforms .....	31
11.1	3.8 V Output Load Transient Response .....	31
11.2	12 V Output Load Transient Response .....	31
11.3	Switching Waveforms.....	32
11.3.1	Drain to Source Voltage and Current during Normal Operation.....	32
11.3.2	Drain to Source Voltage and Current Waveforms during Start-up .....	33
11.3.3	Input and Output Voltages Waveforms during Start-up .....	34
11.3.4	Output Short Auto-Restart .....	36
11.4	Output Ripple Measurements.....	37
11.4.1	Ripple Measurement Technique .....	37



11.4.2	Measurement Results .....	38
12	Conducted EMI.....	40
12.1	Test Set-up Equipment .....	40
12.1.1	Equipment and Load Used .....	40
12.2	Floating Output (QP / AV) .....	41
12.2.1	Line 115 VAC (0.3 W, 12 V and 3.8 V Full Load) .....	41
12.2.2	Line 230 VAC (0.3 W, 12 V and 3.8 V Full Load) .....	42
13	Lightning Surge Test .....	43
13.1	Differential Mode Surge Test .....	43
13.2	Ring Wave Surge Test.....	44
14	Revision History .....	46

**Important Note:**

Although this board is designed to satisfy safety isolation requirements, the engineering prototype has not been agency approved. Therefore, all testing should be performed using an isolation transformer to provide the AC input to the prototype board.



## 1 Introduction

This document is an engineering report describing a dual output 12 V, 20 mA and 3.8 V, 20 mA non-isolated power supply utilizing a device from the LinkSwitch-TN2 family of ICs. This design shows the simplicity and efficiency that is possible due to the high level of integration while still providing exceptional performance.

This document contains the power supply specification, schematic, bill of materials, transformer documentation, printed circuit layout, and performance data.



Figure 1 – Populated Circuit Board Photograph, Top.

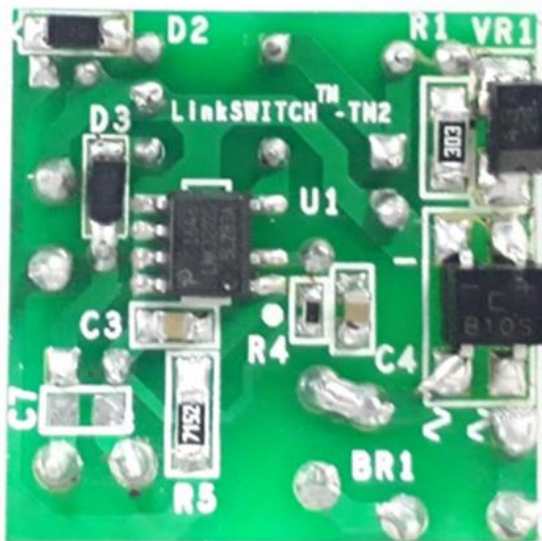


Figure 2 – Populated Circuit Board Photograph, Bottom.

## 2 Power Supply Specification

The table below represents the minimum acceptable performance of the design. Actual performance is listed in the results section.

Description	Symbol	Min	Typ	Max	Units	Comment
<b>Input</b>						
Voltage	$V_{IN}$	85	115/230	277	VAC	2 Wire – No P.E.
Frequency	$f_{LINE}$	47	50/60	64	Hz	
No-load Input Power				12	mW	230 VAC.
<b>Output</b>						
Output Voltage 1	$V_{OUT1}$	10.8	12	13.2	V	±10%.
Output Current 1	$I_{OUT1}$	0	20		mA	
Output Voltage Ripple 1	$V_{RIPPLE1}$			190	mV	20 MHz Bandwidth.
Output Voltage 2	$V_{OUT2}$	3.61	3.8	3.99	V	±5%
Output Current 2	$I_{OUT2}$	4	20		mA	See Figure 14
Output Voltage Ripple 2	$V_{RIPPLE2}$			150	mV	20 MHz Bandwidth.
Peak Power Output	$P_{OUT\_PEAK}$	347			mW	
<b>Environmental</b>						
Conducted EMI			CISPR22B / EN55022B Floating			Resistive Load, 6 dB Margin.
<b>Line Surge</b>						
Differential Mode				500	V	1.2 $\mu$ s / 50 $\mu$ s Surge Mode, 2 $\Omega$ .
Ambient Temperature	$T_{AMB}$	0		24	$^{\circ}$ C	Free Convection, Sea Level in Sealed Enclosure.

### 3 Schematic

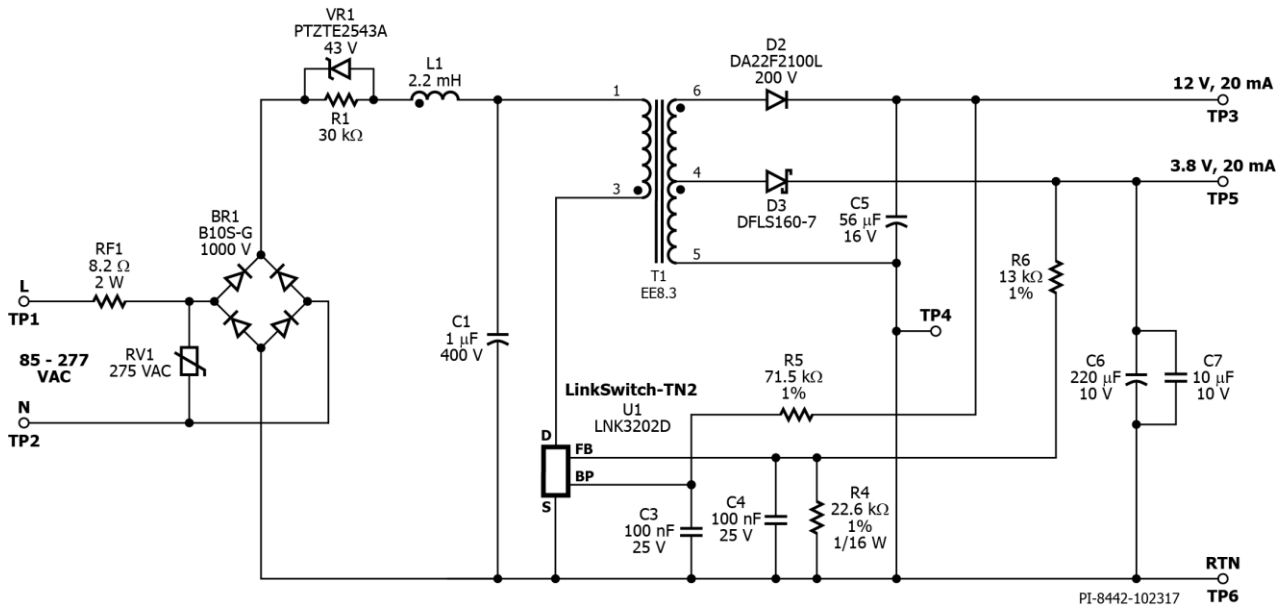


Figure 3 – Schematic.

## 4 Circuit Description

### 4.1 *Input Rectifier, Protection and EMI Filtering*

Bridge Rectifier BR1 rectifies the AC line voltage providing a full wave rectified DC to either pass across R1 or VR1; R1 for a lower standby current at no-load conditions and for VR1 during normal operations. EMI filter consists of inductor L1 and capacitor C1. EMI is further reduced by the integrated frequency jitter feature of the LinkSwitch-TN2 family of devices. Fusible resistor RF1 protects by safely opening the circuit in case of catastrophic failure of any of the components in the circuit. Together with RV1 and C1, they aid in surge protection of the circuit. Varistor RV1 clamps input voltage while RF1 is for inrush current protection. Capacitor C1 is rated at 1  $\mu$ F 400 V to pass the  $\pm$ 500 differential surge, but a 4.7  $\mu$ F can be used if unit needs to pass  $\pm$ 1 kV.

### 4.2 *LinkSwitch-TN2 Primary Side and Main Output Circuit Operation*

The LNK3202D is from the LinkSwitch™-TN2 family of ICs. These ICs incorporate a high power MOSFET, oscillator, On/Off control for highest efficiency, a high-voltage switched current source for self-biasing, frequency jittering, and other protection circuitry all in one device. The LNK3202D IC was used for a non-isolated flyback with dual output (12 V and 3.8 V) both delivering up to 20 mA.

Primary-side of the circuit is connected to the IC through the DRAIN (D) pin. The D pin provides the internal operating current for both the start-up and steady-state operations. During turn on time, current ramps up in the primary winding storing energy in the core of the transformer. The IC senses the current in the power MOSFET and when current threshold ( $I_{LIMIT}$ ) is exceeded, the power MOSFET in U1 is turned off and will remain off for the remainder of that cycle. On/Off control compares the output voltage to a reference. The result is then used to enable or disable the power MOSFET. Through this, regulation of the output is maintained by skipping cycles and without using an error amplifier and ramp generator.

### 4.3 *Regulation of Slave Output*

An additional winding is obtained for the 12 V output. Since the output voltage is higher than  $V_{BP(SHUNT)}$  (5.2 V), R5 is connected from this winding into the BP pin. This was done to achieve the lowest possible no-load consumption.

On the winding for 12 V, 2 turns were added to meet 10% output regulation in full load.

### 4.4 *Output Side and Feedback Loop*

The 3.8 V output is rectified by D3 and C6. Diode D3 is a Schottky barrier rectifier. Since 3.8 V is the main output, a Schottky was used on its output for better efficiency since it reduces rectification loss. Capacitor C7 can be added in parallel with C6 in case ripple

voltages must be lessened. As for the 12 V output, D2 and C5 are used. Diode D2 is a fast switching diode. Both D2 and D3 have a maximum  $t_{RR} = 50$  ns.

Output voltage of 3.8 V is sensed through resistor divider R6 and R4 and fed back to U1. Voltage on FB pin must be maintained at 2 V so resistors are in 1% tolerance. A low cost general purpose capacitor C4 was used in parallel with R4, to prevent pulse bunching.





## 5 PCB Layout

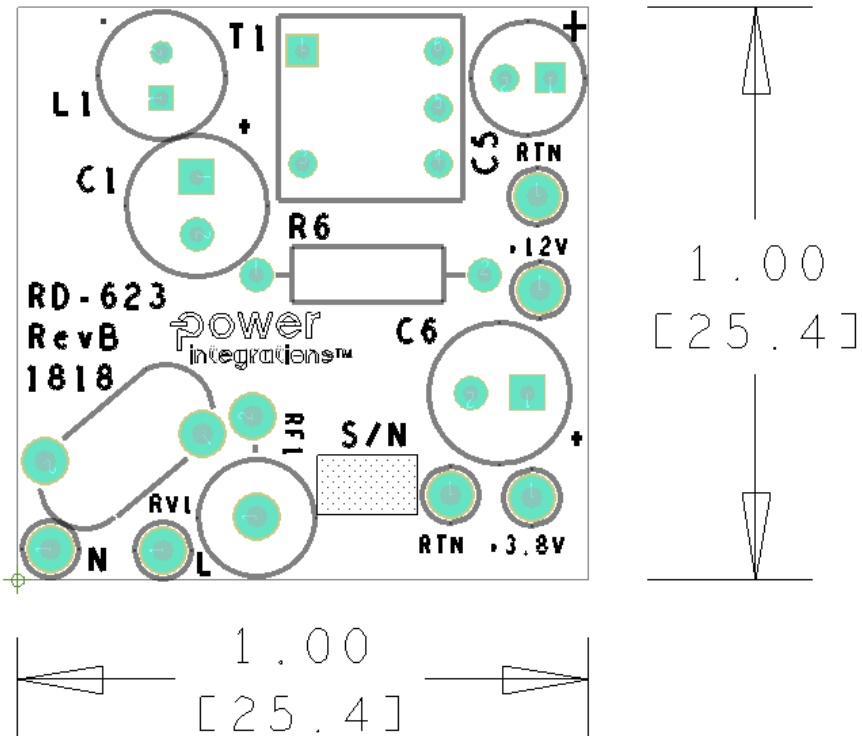


Figure 4 – Printed Circuit Layout, Top.

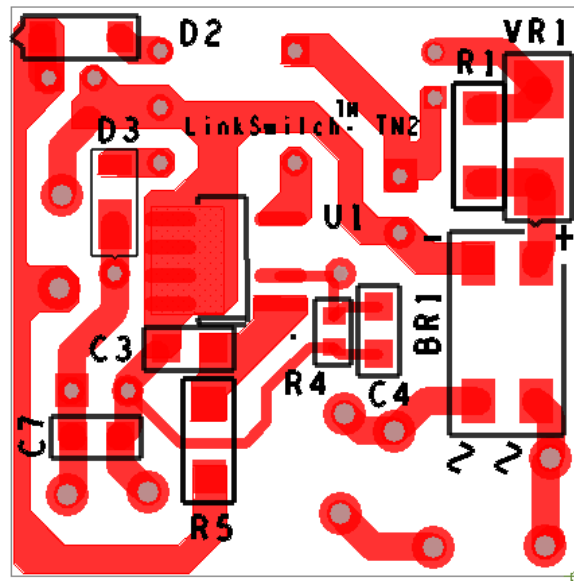


Figure 5 – Printed Circuit Layout, Bottom.

## 6 Bill of Materials

Item	Qty	Ref Des	Description	Mfg Part Number	Mfg
1	1	BR1	1000 V, 0.8 A, Bridge Rectifier, SMD, MBS-1, 4-SOIC	B10S-G	Comchip
2	1	C1	1 $\mu$ F, 400 V, Electrolytic, (6.3 x 11)	EKMG401ELL1R0MF11D	United Chemi-Con
3	2	C3 C4	100 nF, 25 V, Ceramic, X7R, 0805	08053C104KAT2A	AVX
4	1	C5	56 $\mu$ F, 16 V, Electrolytic, Very Low ESR, 22 m $\Omega$ , (10 x 25)	EKZE160ELL560ME11N	Nippon Chemi-Con
5	1	C6	220 $\mu$ F, 10 V, Electrolytic, Very Low ESR, 130 m $\Omega$ , (6.3 x 11)	EKZE100ELL221MF11D	Nippon Chemi-Con
6	1	C7	10 $\mu$ F, 10 V, Ceramic, X7R, 0805	C2012X7R1A106M	TDK
7	1	D2	200 V, 1 A, MINI2	DA22F2100LCT-ND	Panasonic
8	1	D3	60 V, 1 A, DIODE SCHOTTKY, PWRDI 123	DFLS160-7	Diodes, Inc.
9	1	L1	2.2 mH, 0.046 A, 20%	RL-5480-1-2200	Renco
10	1	R1	RES, 30 k $\Omega$ , 5%, 1/4 W, Thick Film, 1206	ERJ-8GEYJ303V	Panasonic
11	1	R4	RES, 22.6 k $\Omega$ , 1%, 1/16 W, Thick Film, 0603	ERJ-3EKF2262V	Panasonic
12	1	R5	RES, 71.5 k $\Omega$ , 1%, 1/4 W, Thick Film, 1206	ERJ-8ENF7152V	Panasonic
13	1	R6	RES, 13 k $\Omega$ , 1%, 1/4 W, Metal Film	MFR-25FBF-13K0	Yageo
14	1	RF1	RES, 8.2 $\Omega$ , 2 W, Fusible/Flame Proof Wire Wound	CRF253-4 8R2	Vitrohm
15	1	RV1	275 VAC, 23 J, 7 mm, RADIAL	V275LA4P	Littlefuse
16	1	T1	Bobbin, EE8.3, Vertical, 6 pins (8.2 mm W x 8.2 mm L x 6.9 mm H) Transformer	EE-0802	Zhenhui
				PNK-32024	Premier Magnetics
17	1	TP1	Test Point, WHT, Miniature THRU-HOLE MOUNT	5002	Keystone
18	3	TP2 TP4 TP6	Test Point, BLK, Miniature THRU-HOLE MOUNT	5001	Keystone
19	1	TP3	Test Point, BLUE, Miniature THRU-HOLE MOUNT	5117	Keystone
20	1	TP5	Test Point, RED, Miniature THRU-HOLE MOUNT	5000	Keystone
21	1	U1	LinkSwitch-TN2, SO-8C	LNK3202D	Power Integrations
22	1	VR1	Diode, Zener, 43 V, $\pm$ 7%, 1 W, PMDS,DO-214AC, SMA	PTZTE2543A	Rohm Semi

## 7 Transformer Specification

### 7.1 Electrical Diagram

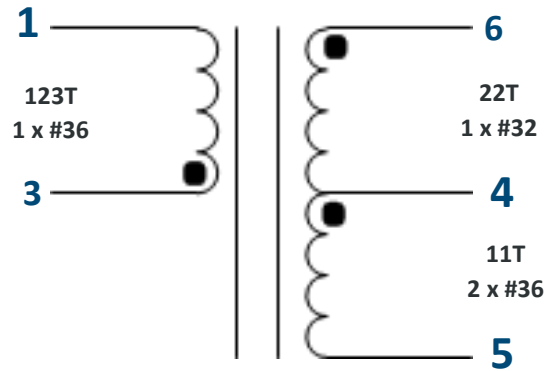


Figure 6 – Transformer Electrical Diagram.

### 7.2 Electrical Specifications

<b>Main Inductance</b>	Pin 1 and pin 3 together, measured at 110 kHz, 0.4 V <sub>RMS</sub> .	796 $\mu$ H $\pm$ 10%
<b>Electrical Strength</b>	1 second, 60 Hz, from primary to secondary.	N/A

### 7.3 Material List

Item	Description
[1]	Core: EE8.3.
[2]	Bobbin: Vertical 6 Pin, EE8.3.
[3]	Magnet Wire: #32 AWG.
[4]	Magnet Wire: #36 AWG.
[5]	Tape, 3M 1298 Polyester Film, 2.0 Mils Thick, 4.5 mm Wide.

### 7.4 Transformer Build Diagram

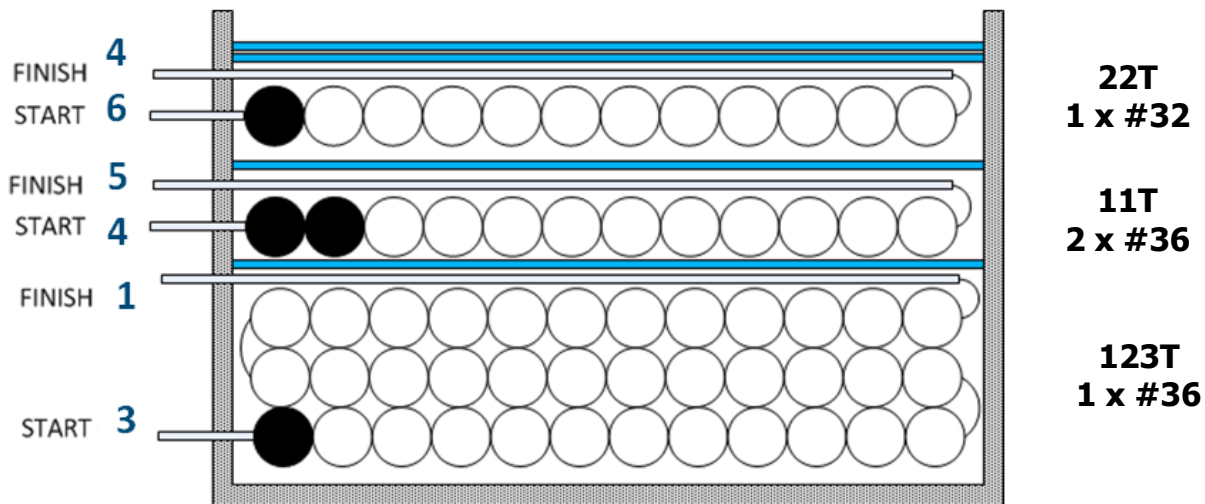
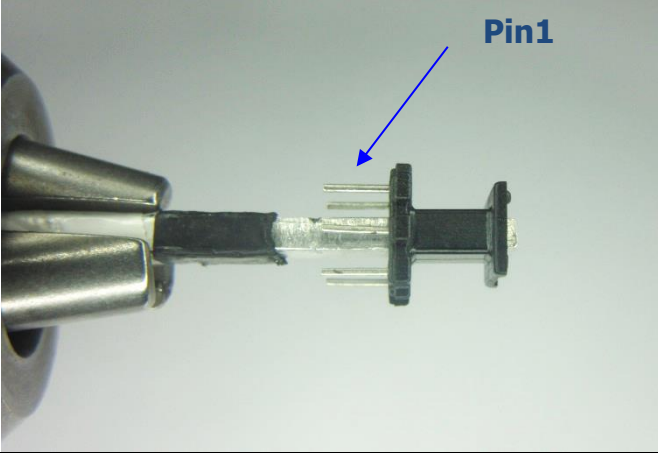
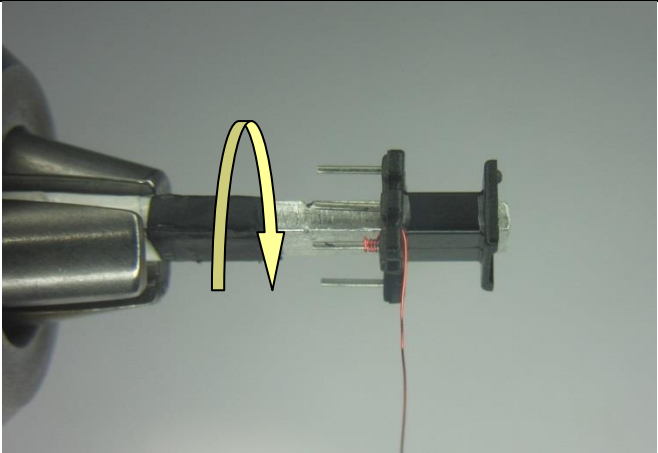
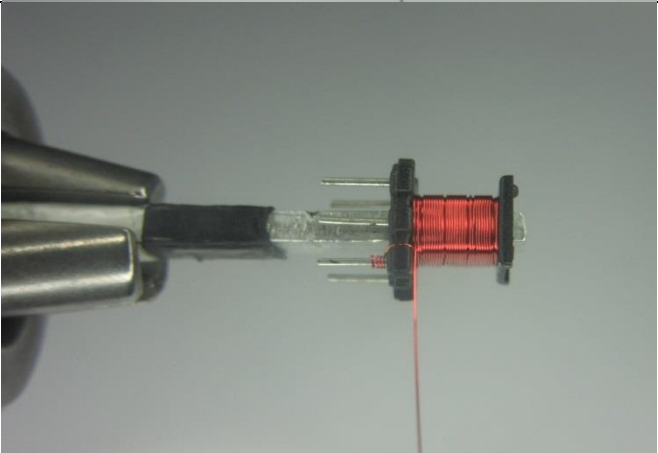


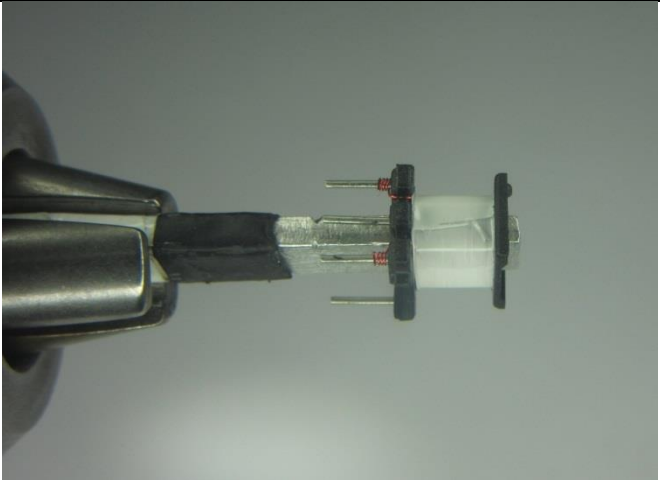
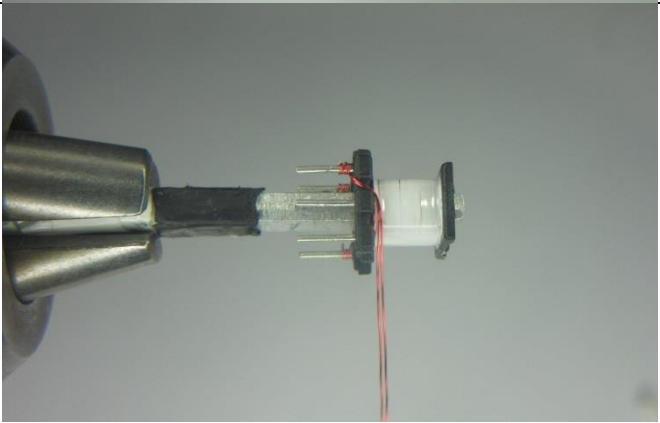
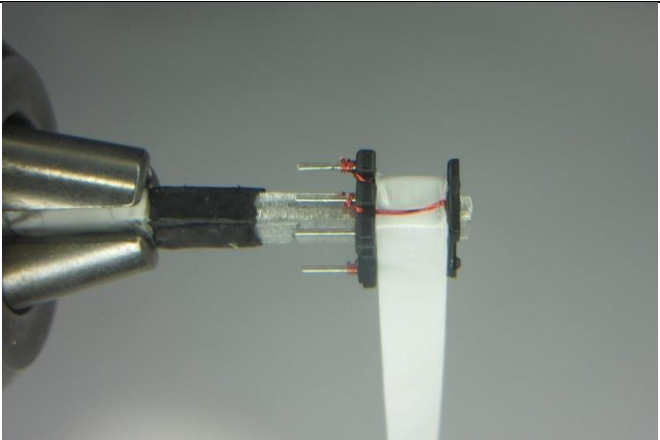
Figure 7 – Transformer Build Diagram.

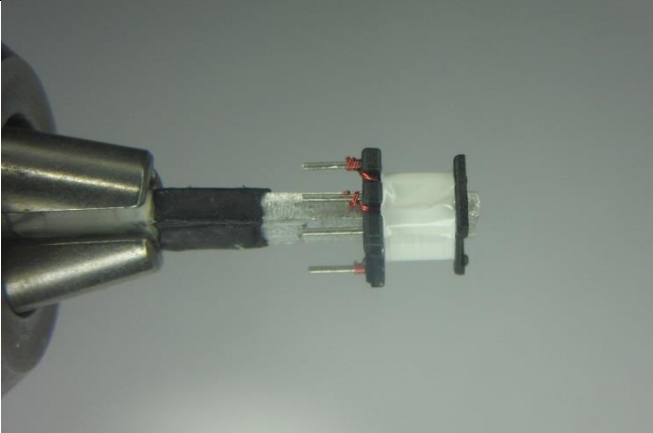
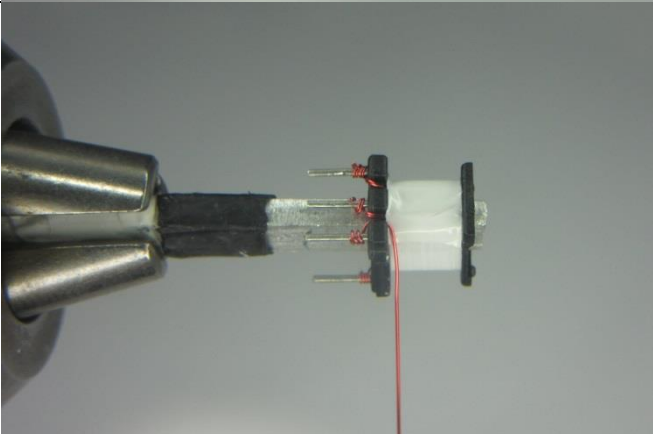
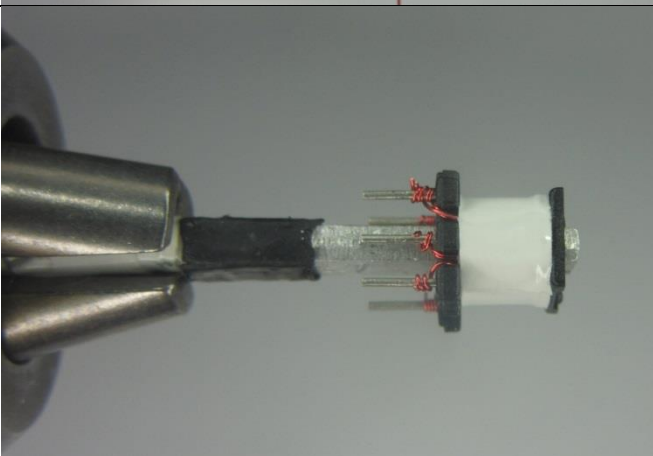
### 7.5 Transformer Instructions

<b>General Note</b>	For the purpose of these instructions, bobbin is oriented on winder such that pin side is on the left side (see illustration). Winding direction as shown is clockwise.
<b>WD1</b>	Starting at pin 3, wind 123 turns of wire Item [4] in four layers. Finish at pin 1.
<b>Tape</b>	Use 1 layer of tape Item [5] for insulation.
<b>WD2</b>	Starting at pin 4, wind 11 turns of two wire Item [3] in one layer. Finish at pin 5. Spread last layer evenly across bobbin.
<b>Tape</b>	Use 1 layer of tape Item [4] for insulation.
<b>WD3</b>	Starting at pin 6, wind 22 turns of wire Item [4] in one layer. Finish at pin 4. Spread last layer evenly across bobbin.
<b>Tape</b>	Use 2 layers of tape Item [4] for insulation.
<b>Assembly</b>	Grind core halves for specified primary inductance, insert bobbin, and secure core halves.

**7.6 Transformer Winding Illustrations**

<p><b>General Note</b></p>		<p>For the purpose of these instructions, bobbin is oriented on winder such that pin side is on the left side (see illustration). Winding direction as shown is clockwise.</p>
<p><b>WD 1</b></p>		<p>Starting at pin 3, wind 123 turns of wire Item [4] in four layers.</p>
<p><b>Tape</b></p>		<p>Finish at pin 1.</p>

		<p>Apply one layer of tape Item [5] for insulation.</p>
<p><b>WD 2</b></p>		<p>Starting at pin 4, wind 22 turns of 2 wire Item [3] in 1 layer, spread last layer evenly across bobbin.</p>
<p><b>Tape</b></p>		<p>Finish at pin 5. Use 1 layer of tape Item [5] for insulation.</p>

		
<p><b>WD 3</b></p>		<p>Starting at pin 6, wind 22 turns of wire Item [4] in 1 layer</p>
<p><b>Tape</b></p>		<p>Finish at Pin 4. Apply two layers of tape in (Item [5]) for insulation.</p>

<p><b>Assembly</b></p>		<p>Grind core halves for specified primary inductance, insert bobbin, and secure core halves.</p>
------------------------	--	---



## 8 Transformer Design Spreadsheet

**Note:** Since the spreadsheet input is limited to a single value for voltage and current and this is a dual output design, the current specification was changed to 27 mA to account for the total combined power of both the 12 V and 3.8 V outputs.

ACDC_LinkSwitchTN2_Flyback_021417; Rev.1.1; Copyright Power Integrations 2017	INPUT	INFO	OUTPUT	UNIT	ACDC_LinkSwitchTN2 Flyback Design Spreadsheet
<b>ENTER APPLICATION VARIABLES</b>					
LINE VOLTAGE RANGE			Universal		AC line voltage range
VACMIN			85.00	Volts	Minimum AC line voltage
VACTYP			115.00	Volts	Typical AC line voltage
VACMAX			265.00	Volts	Maximum AC line voltage
fL			50	Hertz	AC mains frequency
TIME_BRIDGE_CONDUCTION			2.52	mseconds	Input bridge rectifier diode conduction time
LINE RECTIFICATION	F		F		Select 'F'ull wave rectification or 'H'alf wave rectification
VOUT	12.00		12.00	Volts	Output voltage
IOUT	0.027		0.027	Amperes	Average output current specification
CC THRESHOLD VOLTAGE			0.00	Volts	Voltage drop across the sense resistor
OUTPUT CABLE RESISTANCE			0.00	Ohms	Enter the resistance of the output cable (if used)
EFFICIENCY	0.85		0.85		Efficiency Estimate at output terminals. Under 0.8 if no better data available
LOSS ALLOCATION FACTOR			0.50		The ratio of power losses during the MOSFET off-state to the total system losses
POUT			0.32	Watts	Continuous Output Power
CIN			1.00	uFarads	Input capacitor
VMIN			93.52	Volts	Valley of the rectified VACMIN
VMAX			374.77	Volts	Peak of the VACMAX
FEEDBACK	BIAS		BIAS		Select the type of feedback required
BIAS WINDING	NO		NO		Select whether a bias winding is required
<b>LINKSWITCH-TN2 VARIABLES</b>					
CURRENT LIMIT MODE	STD		STD		Pick between RED(Reduced) or STD(Standard) current limit mode of operation
PACKAGE	SO-8C		SO-8C		Device package
GENERIC DEVICE	Auto		LNK3202		Device series
DEVICE CODE			LNK3202P		Device code
VOR	50		50	Volts	Voltage reflected to the primary winding when the MOSFET is off
VDS ON			10.0	Volts	MOSFET on-time drain to source voltage
VDS OFF			499.8	Volts	MOSFET off-time drain to source voltage
ILIMITMIN			0.126	Amperes	Minimum current limit
ILIMITTYP			0.136	Amperes	Typical current limit
ILIMITMAX			0.146	Amperes	Maximum current limit
FSMIN			62000	Hertz	Minimum switching frequency
FSTYP			66000	Hertz	Typical switching frequency
FSMAX			72000	Hertz	Maximum switching frequency
RDSON			88.40	Ohms	MOSFET drain to source resistance
<b>PRIMARY WAVEFORM PARAMETERS</b>					
MODE OF OPERATION			DCM		Mode of operation
KRP/KDP			7.665		Measure of continuous/discontinuous mode of operation
KP_TRANSIENT			2.656		KP under conditions of a transient
DMAX			0.072		Maximum duty cycle

TIME_ON			1.168	useconds	MOSFET conduction time at the minimum line voltage
TIME_ON_MIN			0.346	useconds	MOSFET conduction time at the maximum line voltage
I AVG_PRIMARY			0.005	Amperes	Average input current
IRMS_PRIMARY			0.020	Amperes	Root mean squared value of the primary current
LPRIMARY_MIN			716	uH	Minimum primary inductance
LPRIMARY_TYP			796	uH	Typical primary inductance
LPRIMARY_MAX			876	uH	Maximum primary inductance
LPRIMARY_TOL			10		Primary inductance tolerance
<b>SECONDARY WAVEFORM PARAMETERS</b>					
IPEAK_SECONDARY			0.579	Amperes	Peak secondary current
IRMS_SECONDARY			0.116	Amperes	Root mean squared value of the secondary current
PIV_SECONDARY			106.45	Volts	Peak inverse voltage on the secondary diode, not including the leakage spike
VF_SECONDARY			0.70	Volts	Secondary diode forward voltage drop
<b>TRANSFORMER CONSTRUCTION PARAMETERS</b>					
<b>Core selection</b>					
CORE	EE8		EE8		Select the transformer core
BOBBIN			B-EE8-H		Select the bobbin
AE			7.00	mm^2	Cross sectional area of the core
LE			19.20	mm	Effective magnetic path length of the core
AL			610.0	nH/(turns^2)	Ungapped effective inductance of the core
VE			0.0	mm^3	Volume of the core
AW			0.00	mm^2	Window area of the bobbin
BW			4.78	mm	Width of the bobbin
MLT			0.00	mm	Mean length per turn of the bobbin
MARGIN			0.00	mm	Safety margin
Primary winding					
NPRIMARY			123		Primary number of turns
BMAX_TARGET			1500	Gauss	Target value of the magnetic flux density
BMAX_ACTUAL			1350	Gauss	Actual value of the magnetic flux density
BAC			675	Gauss	AC flux density
ALG			53	nH/T^2	Gapped core effective inductance
LG			0.153	mm	Core gap length
LAYERS_PRIMARY			2		Number of primary layers
AWG_PRIMARY			40		Primary winding wire AWG
OD_PRIMARY_INSULATED			0.098	mm	Primary winding wire outer diameter with insulation
OD_PRIMARY_BARE			0.080	mm	Primary winding wire outer diameter without insulation
CMA_PRIMARY		Info	505	mil^2/Amperes	The primary winding wire CMA is higher than 500 mil^2/Amperes: Decrease the primary layers or wire thickness
Secondary winding					
NSECONDARY			31		Secondary turns
AWG_SECONDARY			36		Secondary winding wire AWG
OD_SECONDARY_INSULATED			0.432	mm	Secondary winding wire outer diameter with insulation
OD_SECONDARY_BARE			0.127	mm	Secondary winding wire outer diameter without insulation
CMA_SECONDARY			215	mil^2/Amperes	Secondary winding CMA
Bias winding					
NBIAS			N/A		Bias turns
VF_BIAS			N/A	Volts	Bias diode forward voltage drop
VBIAS			N/A	Volts	Bias winding voltage
PIVB			N/A	Volts	Peak inverse voltage on the bias diode
CBP			0.1	uF	BP pin capacitor
<b>FEEDBACK PARAMETERS</b>					



DIODE_BIAS			1N4003-4007		Recommended diode is 1N4003. Place diode on return leg of bias winding for optimal EMI
RUPPER			500 - 1000	ohms	CV bias resistor for CV/CC circuit. See LinkSwitch-TN2 Design Guide
RLOWER			3000	ohms	Resistor to set CC linearity for CV/CC circuit. See LinkSwitch-TN2 Design Guide
<b>MULTIPLE OUTPUT PARAMETERS</b>					
<b>Output 1</b>					
VOUT1			12.00	Volts	Output Voltage 1
IOUT1	0.020		0.020	Amperes	Output Current 1
POUT1			0.24	Watts	Output Power 1
VD1			0.70	Volts	Secondary diode forward voltage drop for output 1
NS1			31		Number of turns for output 1
ISRMS1			0.086	Amperes	Root mean squared value of the secondary current for output 1
IRIPPLE1			0.084	Amperes	Current ripple on the secondary waveform for output 1
PIV1			106.45	Volts	Peak inverse voltage on the secondary diode for output 1
DIODE1_RECOMMENDED			MUR120		Recommended diode for output 1
PRELOAD			4.02	kohms	Preload resistor to ensure a load of at least 3mA on the first output
CMS1			17.2	Cmils	Bare conductor effective area in circular mils for output 1
AWGS1			37	AWG	Wire size for output 1
<b>Output 2</b>					
VOUT2	3.80		3.80	Volts	Output Voltage 2
IOUT2	0.020		0.020	Amperes	Output Current 2
POUT2			0.08	Watts	Output Power 2
VD2			0.70	Volts	Secondary diode forward voltage drop for output 2
NS2			11		Number of turns for output 2
ISRMS2			0.086	Amperes	Root mean squared value of the secondary current for output 2
IRIPPLE2			0.084	Amperes	Current ripple on the secondary waveform for output 2
PIV2			37.32	Volts	Peak inverse voltage on the secondary diode for output 2
DIODE2_RECOMMENDED			SB160		Recommended diode for output 2
CMS2			17.2	Cmils	Bare conductor effective area in circular mils for output 2
AWGS2			37	AWG	Wire size for output 2

## 9 Performance Data

### 9.1 Full Load Efficiency vs. Input Line Voltage

#### 9.1.1 Efficiency vs. Line Voltage, 0.3 W (20 mA on 12 V, 20 mA on 3.8 V)

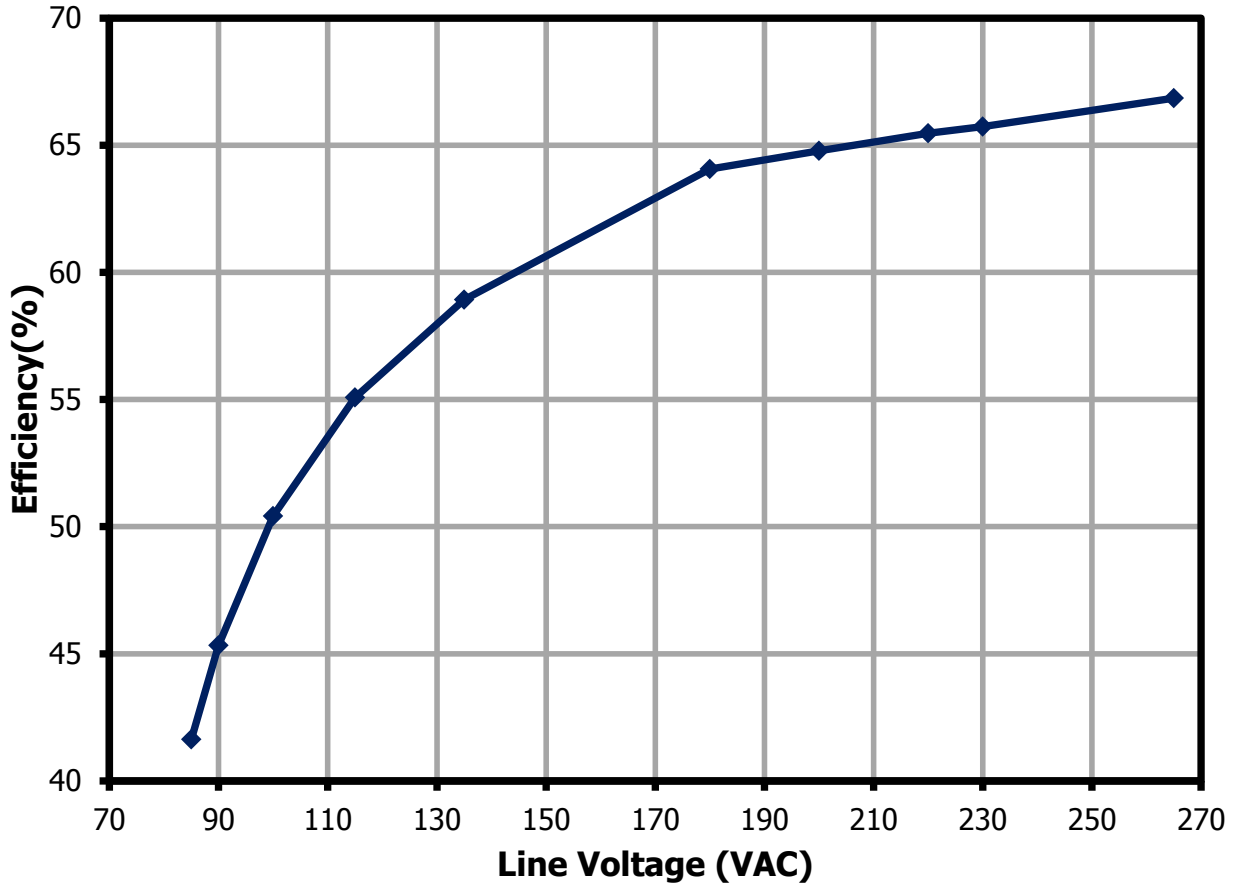
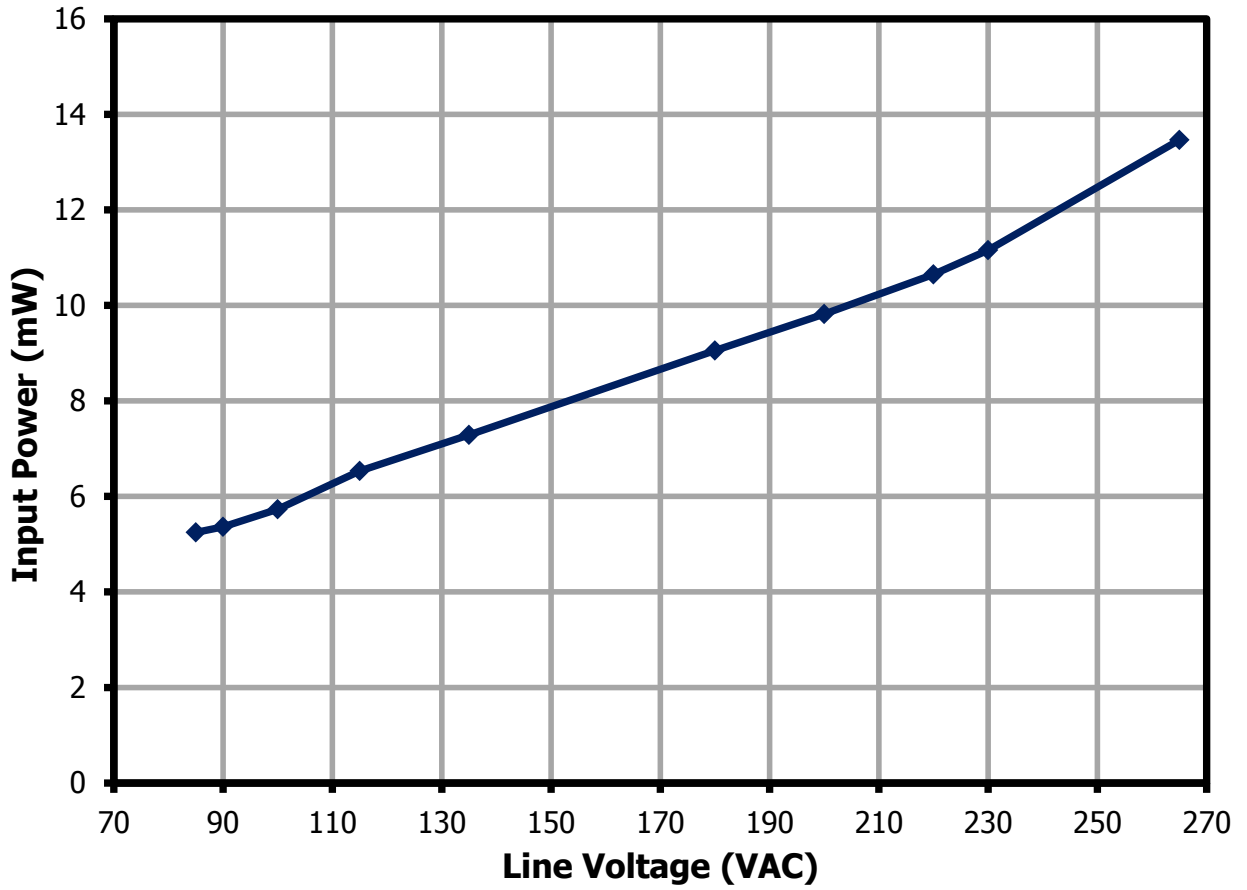


Figure 8 – Efficiency vs. Line Voltage, Room Temperature.

**9.2 No-Load Input Power**



**Figure 9** – No-Load Input Power vs. Input Line Voltage, Room Temperature.



### 9.3 Various Load Current vs. Input Line Voltage

Note: 0-100% load applied on 3.8 V with 12 V unloaded.

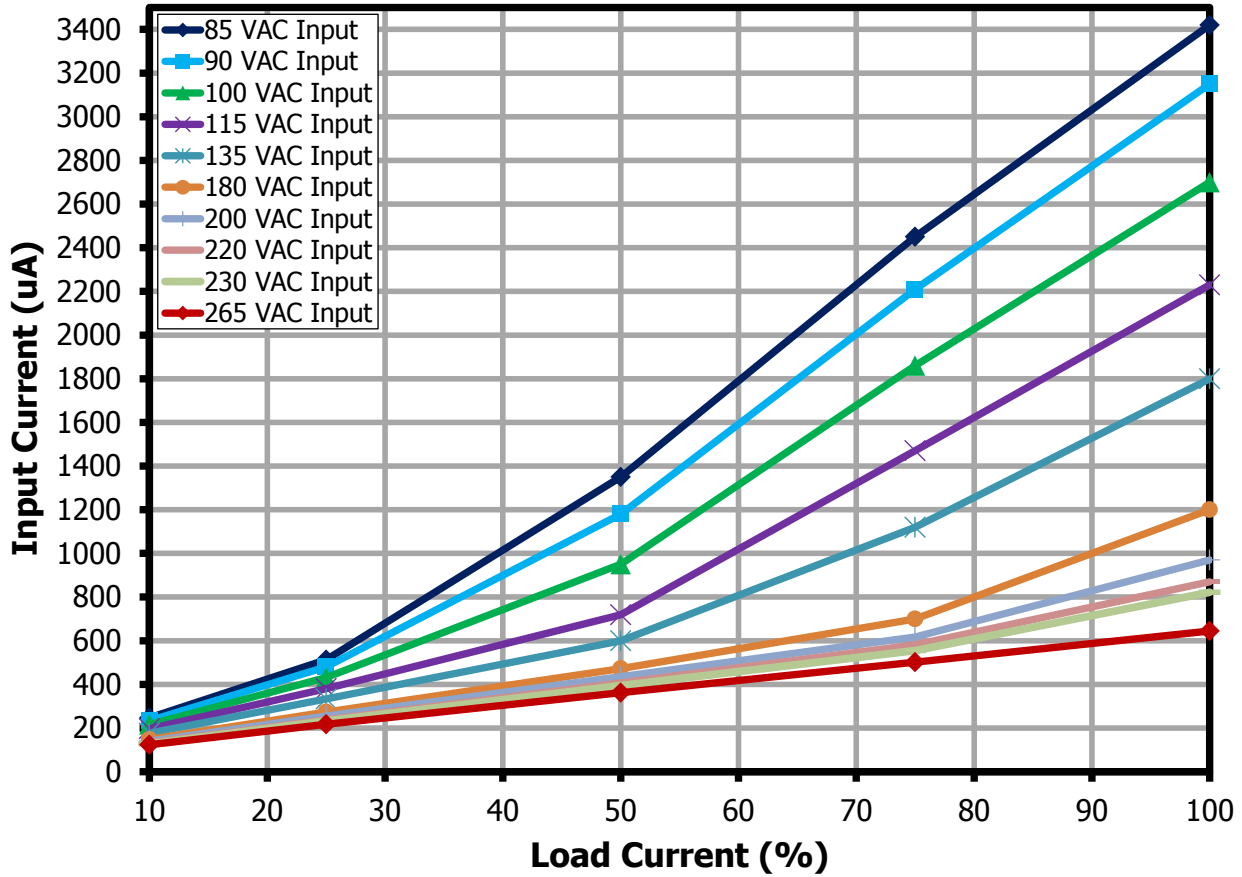
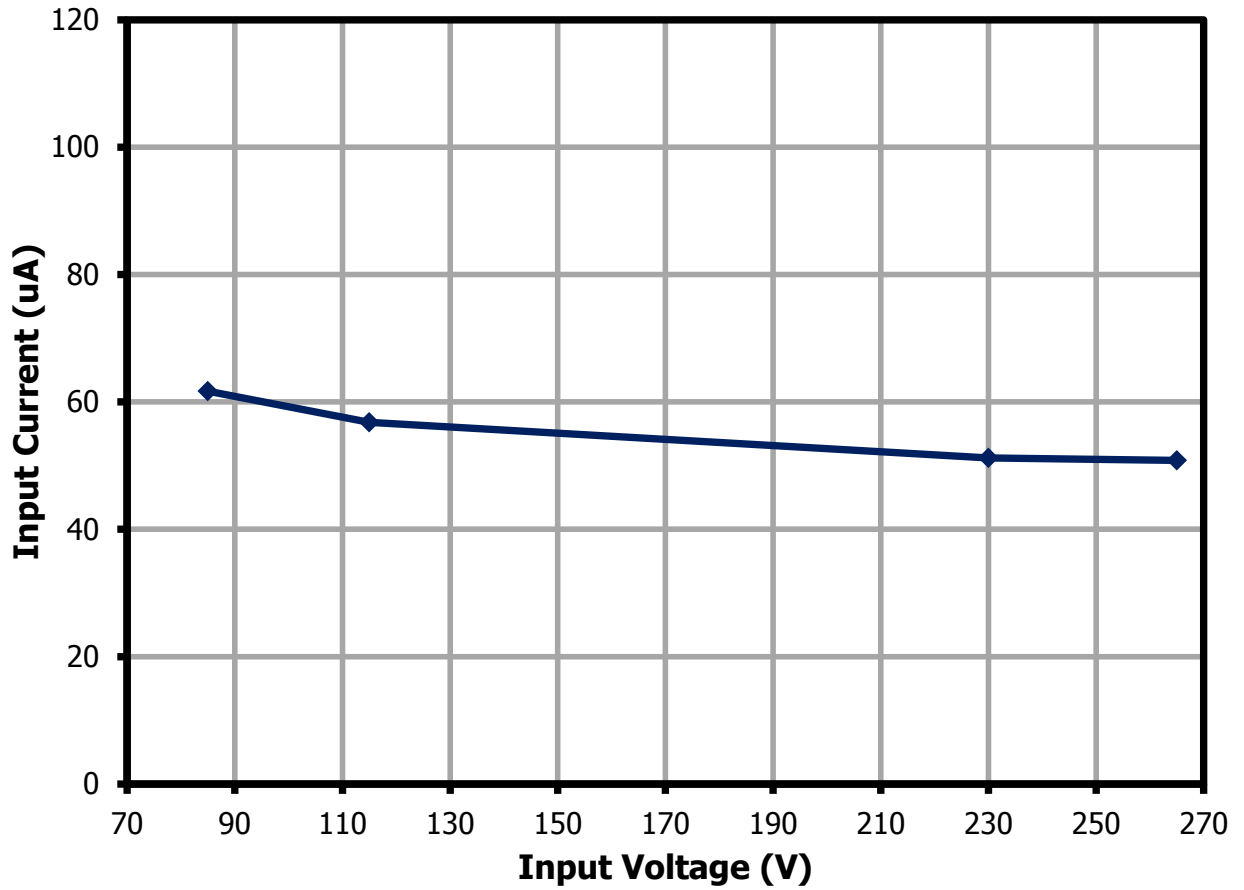


Figure 10 – Various Load Current vs Input Line Voltage, Room Temperature.

**9.4 Input Current at Standby vs. Input Line Voltage**



**Figure 11** – Input Current at Standby vs. Input Line Voltage, Room Temperature.



### 9.5 Line and Load Regulation

#### 9.5.1 12 V Line Regulation at 0.3 W (20 mA on 12 V, 20 mA on 5 V)

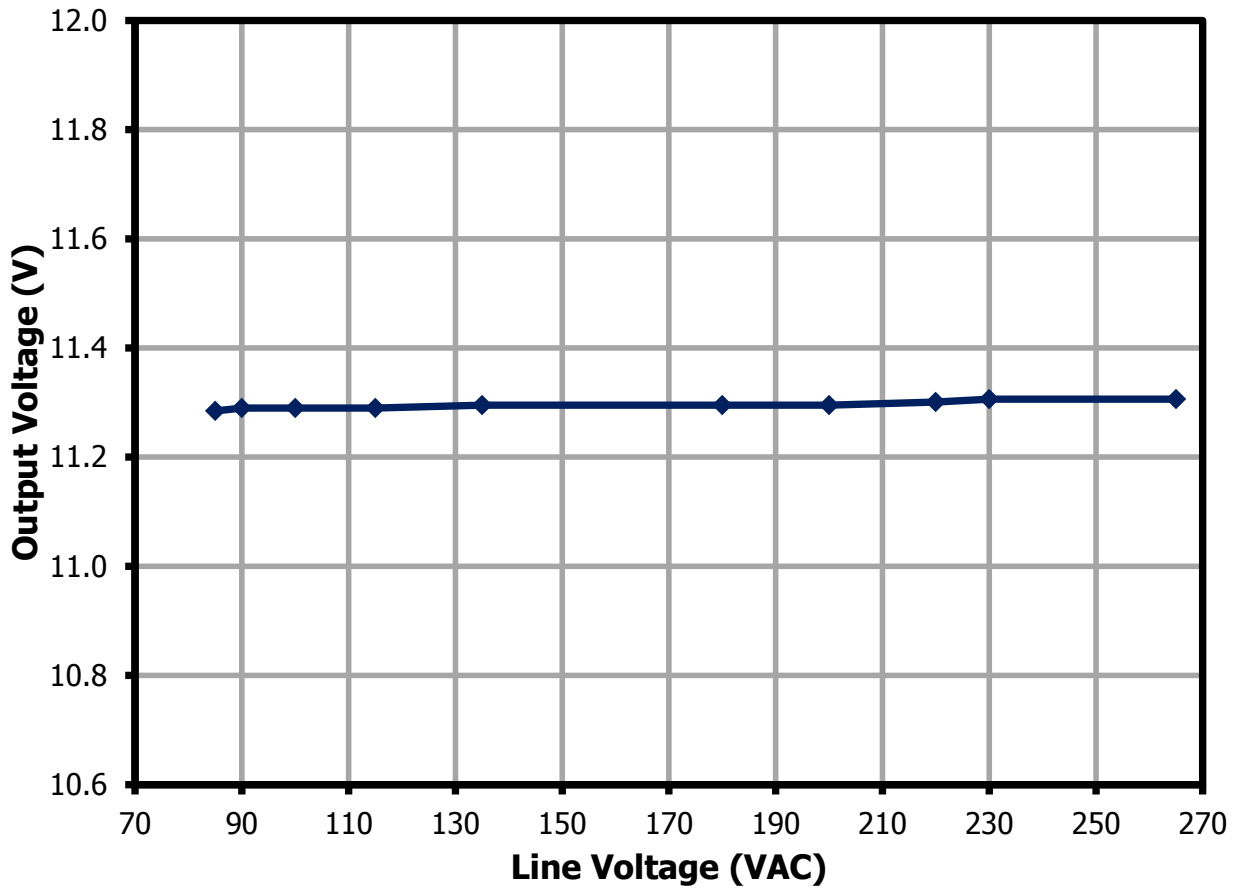


Figure 12 – 12 V Output Voltage vs. Input Line Voltage, Room Temperature.



9.5.2 3.8 V Line Regulation at 0.3 W (20 mA on 12 V, 20 mA on 3.8 V)

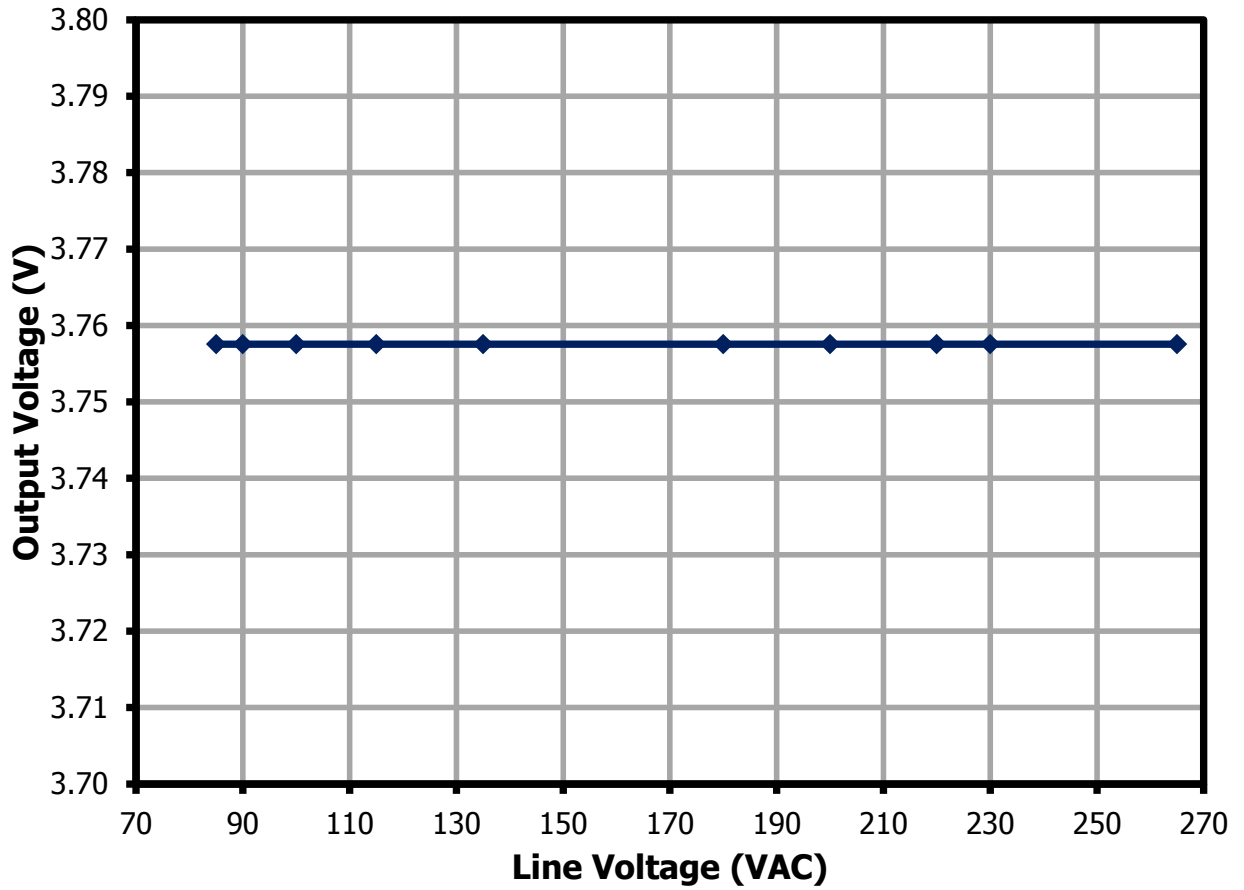


Figure 13 – 3.8 V Output Voltage vs. Input Line Voltage, Room Temperature.



9.5.3 3.8 V Regulation with Varying Load (12 V Unloaded)

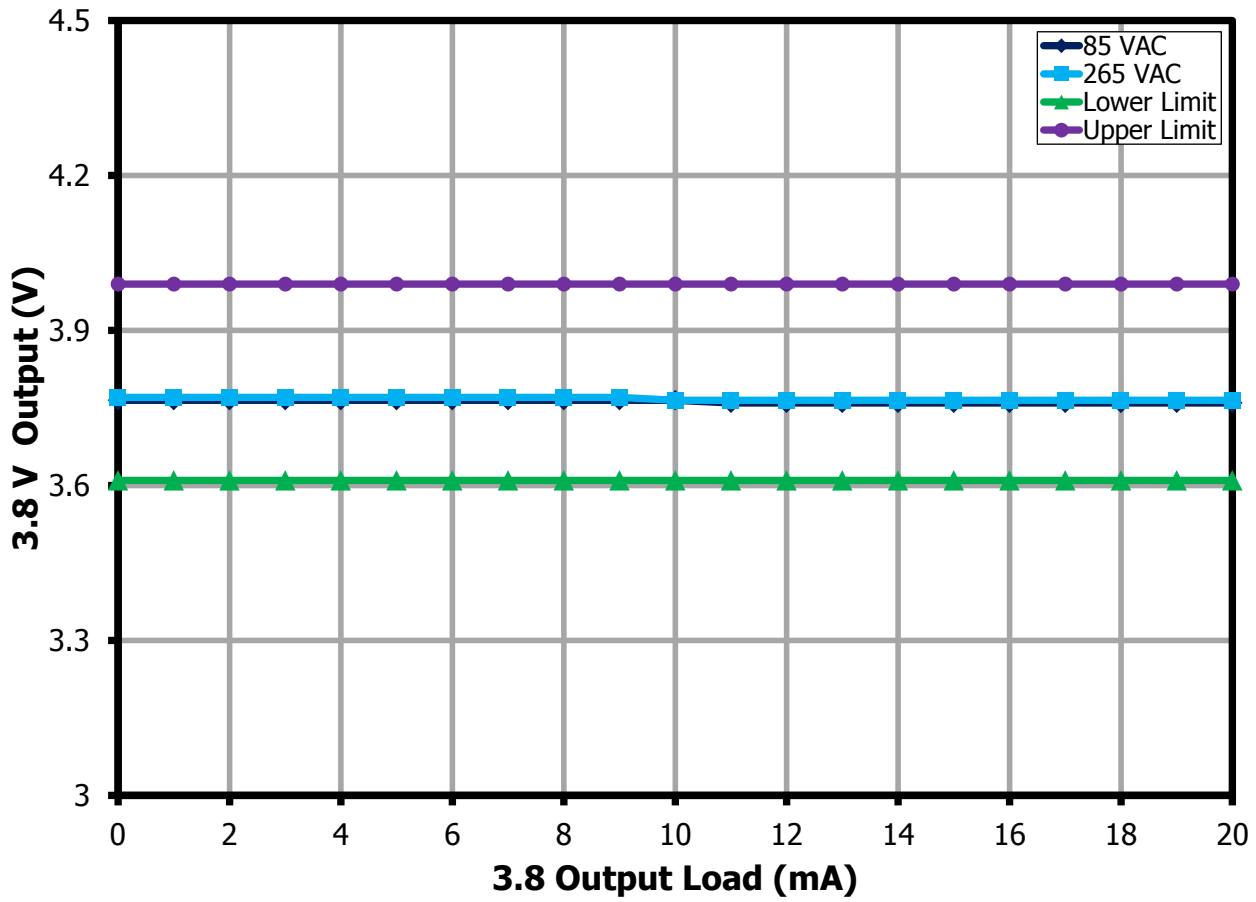


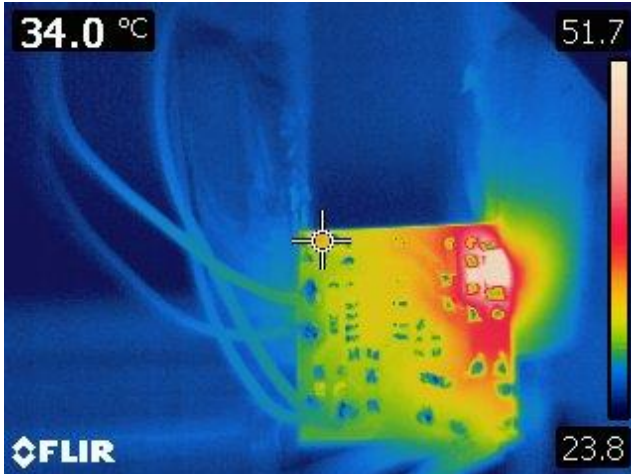
Figure 14 – 3.8 V Output Voltage with Varying Load.

## 10 Thermal Performance

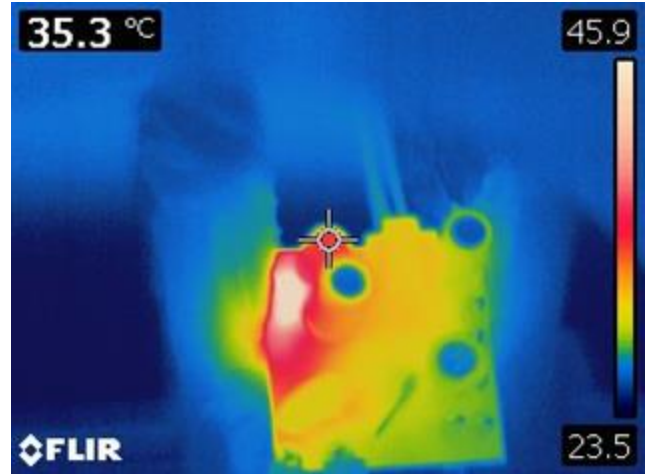
### 10.1 Open Case

For thermal measurement, soak the power supply first for 1 hour. It is recommended that the power supply be placed in an enclosure box to ensure that the ambient temperature is within the room temperature. Add a thermocouple to monitor ambient temperature.

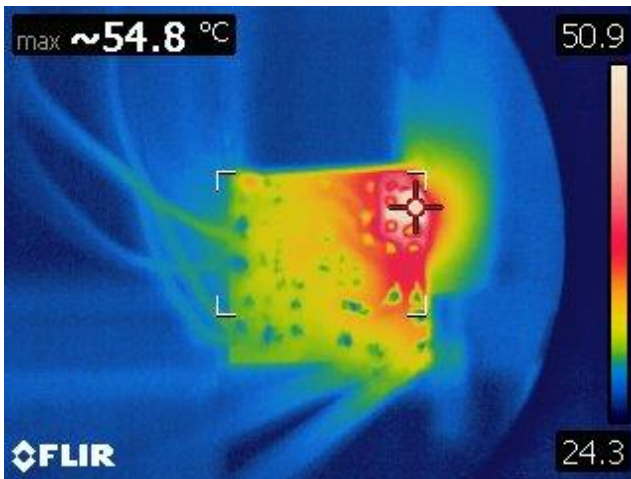
### 10.2 85 VAC at Room Temperature



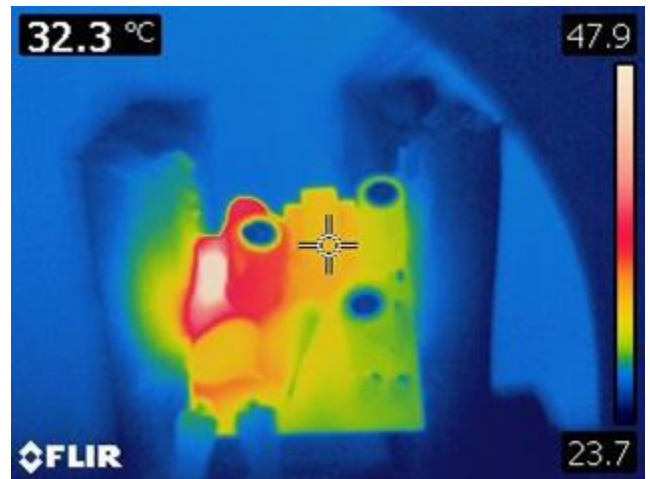
**Figure 15** – Measured Temperature at 0.3 W,  
Ambient Temperature = 24 °C.  
D2 – 12 V Output Diode.  
Spot Temperature = 34 °C.



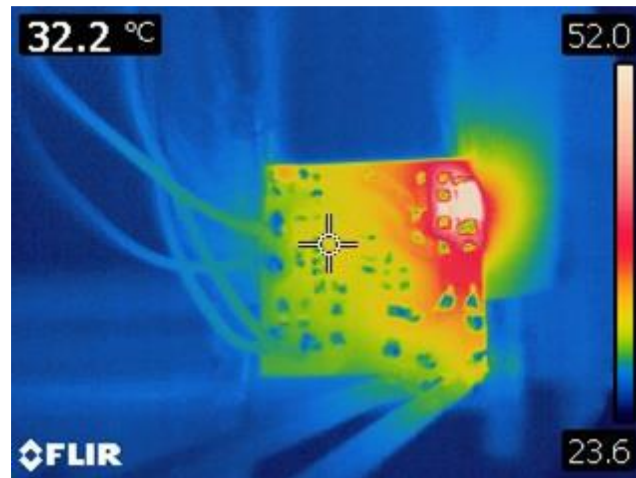
**Figure 16** – Measured Temperature at 0.3 W,  
Ambient Temperature = 24 °C.  
L1 – Inductor.  
Spot Temperature = 35.3 °C.



**Figure 17** – Measured Temperature at 0.3 W,  
Ambient Temperature = 24 °C.  
VR1 – Zener Diode.  
Spot Temperature = 54.8 °C

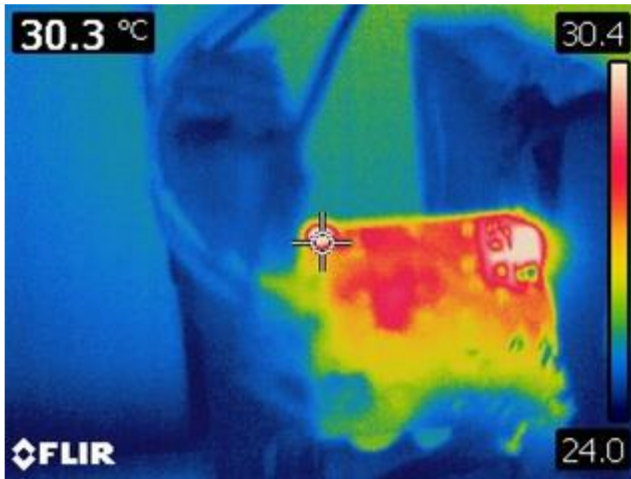


**Figure 18** – Measured Temperature at 0.3 W,  
Ambient Temperature = 24 °C.  
T1 – Transformer.  
Spot Temperature = 55.1 °C.

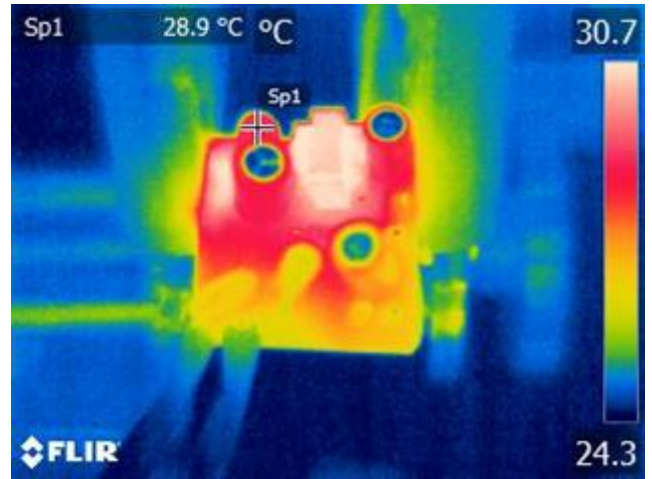


**Figure 19** – Measured Temperature at 0.3 W,  
Ambient Temperature = 24 °C.  
D3 – 3.8 V Output Diode.  
Spot Temperature = 32.2 °C.

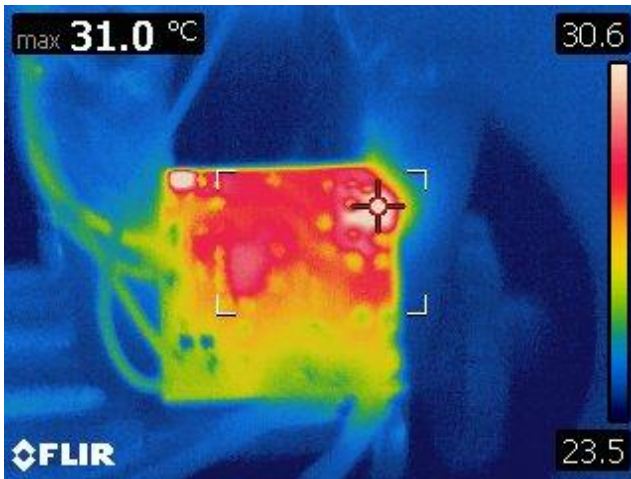
**10.3 265 VAC at Room Temperature**



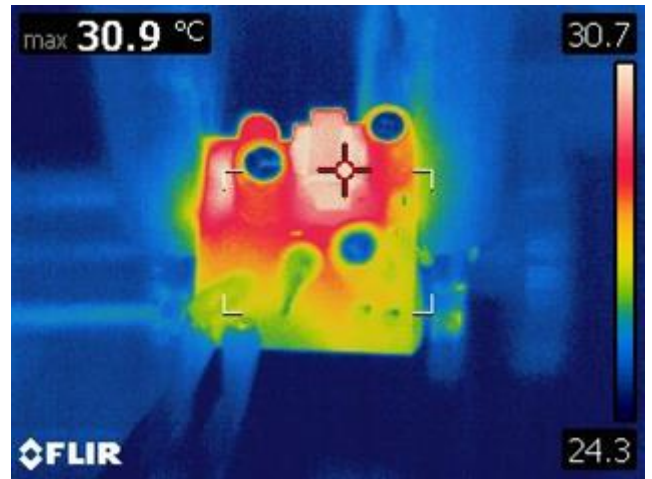
**Figure 20** – Measured Temperature at 0.3 mW,  
Ambient Temperature = 24 °C.  
D2 – 12 V Output Diode.  
Spot Temperature = 30.3 °C.



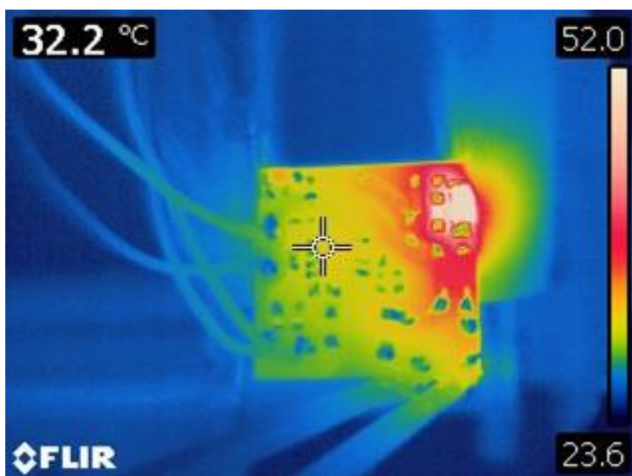
**Figure 21** – Measured Temperature at 0.3 mW,  
Ambient Temperature = 24 °C.  
L1 – Inductor  
Spot Temperature = 28.9 °C.



**Figure 22** – Measured Temperature at 0.3 mW,  
Ambient Temperature = 24 °C  
VR1 – Zener Diode.  
Spot Temperature = 31 °C.



**Figure 23** – Measured Temperature at 0.3 mW,  
Ambient Temperature = 24 °C.  
T1 – Transformer.  
Spot Temperature = 30.9 °C.

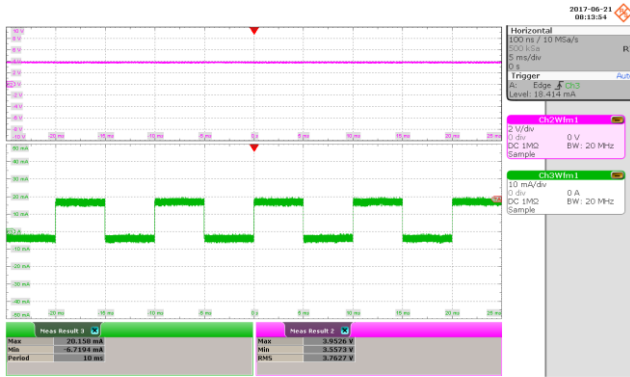


**Figure 24** – Measured Temperature at 0.3 mW,  
Ambient Temperature = 24 °C  
D3 – 3.8 V Output Diode.  
Spot Temperature = 32.2 °C.

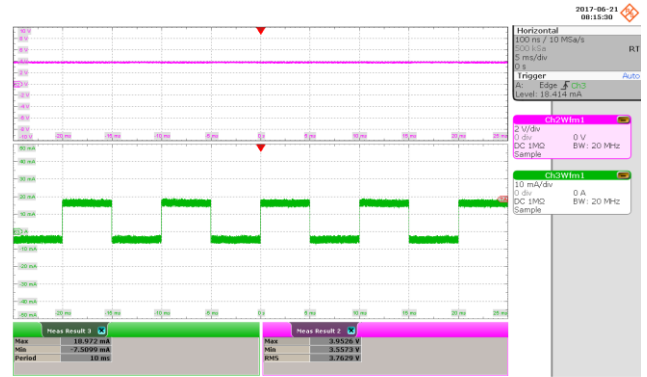
## 11 Waveforms

### 11.1 3.8 V Output Load Transient Response

Results were taken at the output terminal which is the typical specified measurement condition. The 3.8 V output is loaded with 20 mA (full load).



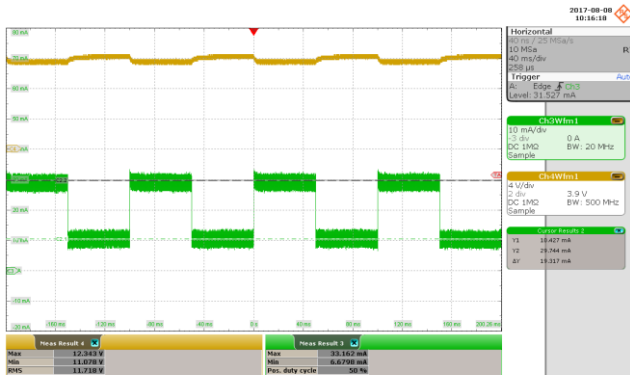
**Figure 25** – 85 VAC, 0-100% Load Step.  
 $V_{MAX}$ : 3.9526 V.  
 $V_{MIN}$ : 3.5573 V.  
 Upper:  $V_{OUT}$ , 1 V / div.  
 Lower:  $I_{LOAD}$ , 10 mA / div., 5 ms / div.



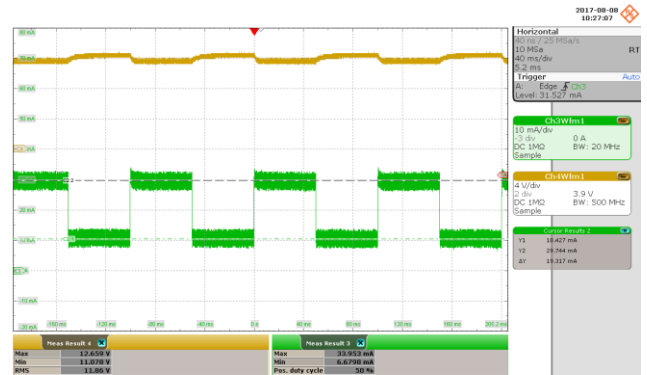
**Figure 26** – 265 VAC, 0-100% Load Step.  
 $V_{MAX}$ : 3.9526 V.  
 $V_{MIN}$ : 3.5573 V.  
 Upper:  $V_{OUT}$ , 1 V / div.  
 Lower:  $I_{LOAD}$ , 10 mA / div., 5 ms / div.

### 11.2 12 V Output Load Transient Response

Results were taken at the output terminal of 12 V loaded with 20mA. 3.8 V Output was loaded with 5 mA.



**Figure 27** – 85 VAC, 0-100% Load Step.  
 $V_{MAX}$ : 12.343 V.  
 $V_{MIN}$ : 11.078 V.  
 Upper:  $V_{OUT}$ , 4 V / div.  
 Lower:  $I_{LOAD}$ , 10 mA / div., 40 ms / div.

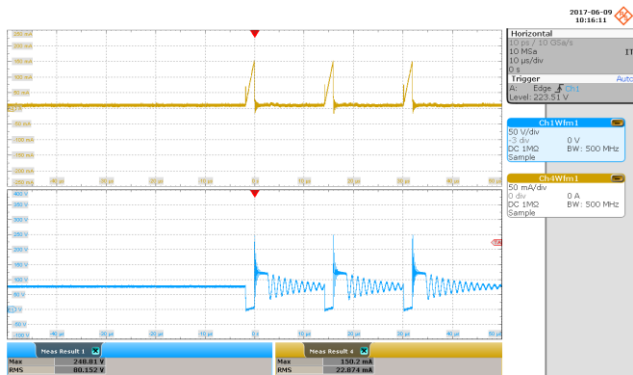


**Figure 28** – 265 VAC, 0-100% Load Step.  
 $V_{MAX}$ : 12.343 V.  
 $V_{MIN}$ : 11.078 V.  
 Upper:  $V_{OUT}$ , 4 V / div.  
 Lower:  $I_{LOAD}$ , 10 mA / div., 40 ms / div.

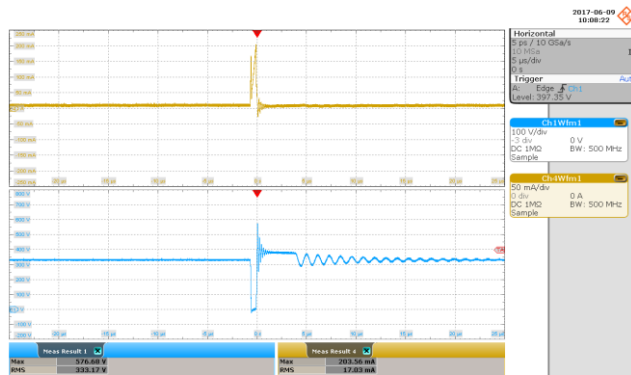


### 11.3 Switching Waveforms

#### 11.3.1 Drain to Source Voltage and Current during Normal Operation



**Figure 29** – 85 VAC Input.  
 Condition: 3.8 V – 20 mA, 12 V – 0 A.  
 Upper:  $I_{DRAIN}$ , 50 mA / div.  
 Lower:  $V_{DRAIN}$ , 50 V / div., 10  $\mu$ s / div.



**Figure 30** – 265 VAC Input.  
 Condition: 3.8 V – 20 mA, 12 V – 0 A.  
 Upper:  $I_{DRAIN}$ , 50 mA / div.  
 Lower:  $V_{DRAIN}$ , 100 V / div., 5  $\mu$ s / div.



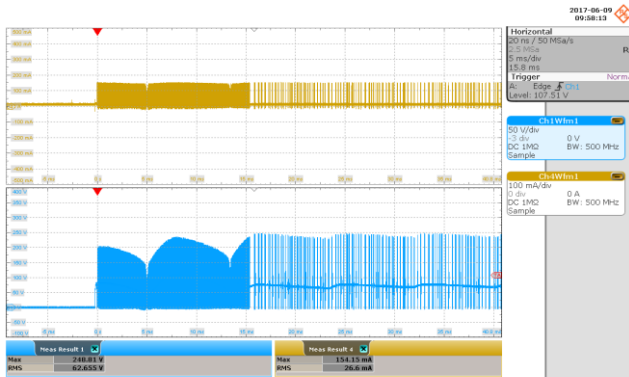
**Figure 31** – 85 VAC Input.  
 Condition: 3.8 V – 20 mA, 12 V – 20 mA.  
 Upper:  $I_{DRAIN}$ , 50 mA / div.  
 Lower:  $V_{DRAIN}$ , 50 V / div., 10  $\mu$ s / div.



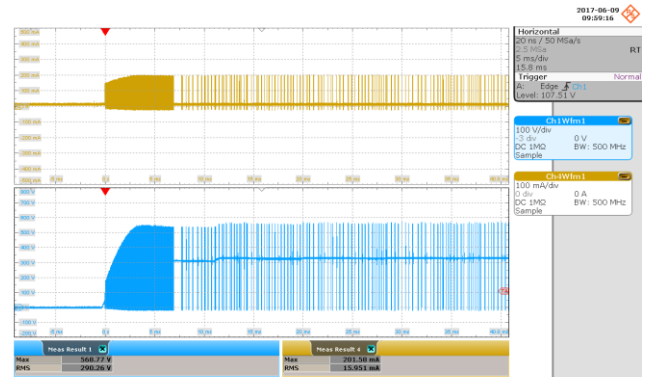
**Figure 32** – 265 VAC Input.  
 Condition: 3.8 V – 20 mA, 12 V – 20 mA.  
 Upper:  $I_{DRAIN}$ , 50 mA / div.  
 Lower:  $V_{DRAIN}$ , 100 V / div., 5  $\mu$ s / div.



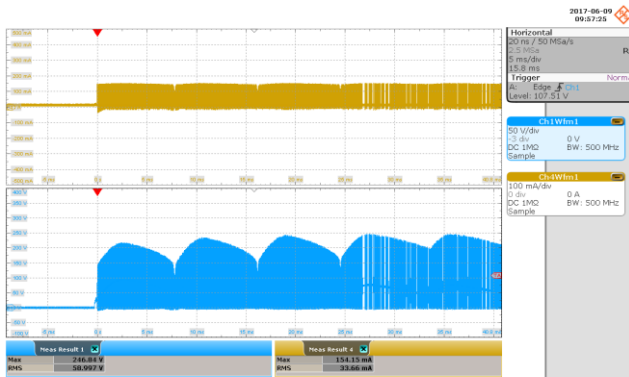
11.3.2 Drain to Source Voltage and Current Waveforms during Start-up



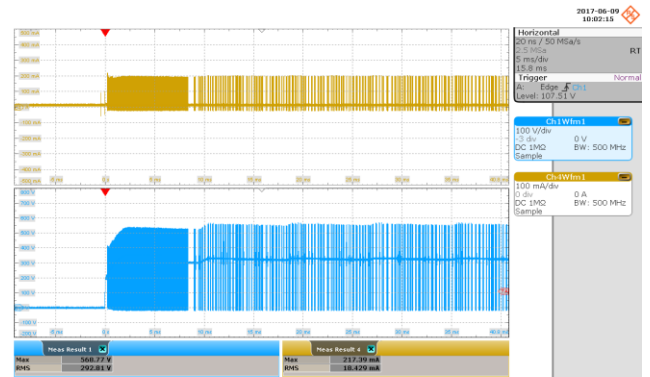
**Figure 33 – 85 VAC Input.**  
 Condition: 3.8 V – 20 mA, 12 V – 0 A.  
 Upper:  $V_{DRAIN}$ , 50 V, 5 ms / div.  
 Lower:  $I_{DRAIN}$ , 100 mA / div.



**Figure 34 – 265 VAC Input.**  
 Condition: 3.8 V – 20 mA, 12 V – 0 A.  
 Upper:  $V_{DRAIN}$ , 100 V, 5 ms / div.  
 Lower:  $I_{DRAIN}$ , 100 mA / div.



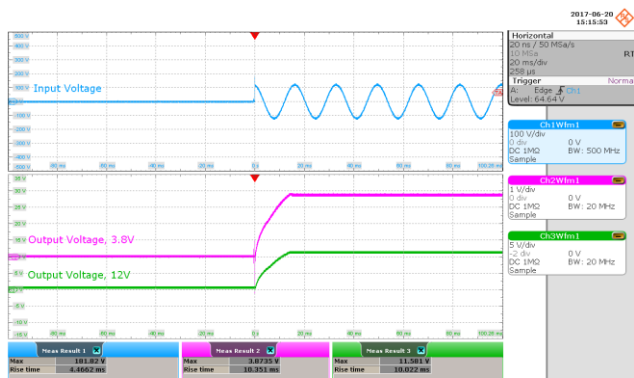
**Figure 35 – 85 VAC Input.**  
 Condition: 3.8 V – 20 mA, 12 V – 20 mA.  
 Upper:  $V_{DRAIN}$ , 50 V, 5 ms / div.  
 Lower:  $I_{DRAIN}$ , 100 mA / div.



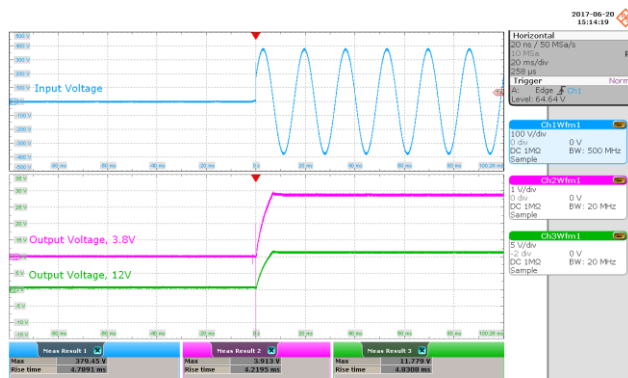
**Figure 36 – 265 VAC Input.**  
 Condition: 3.8 V – 20 mA, 12 V – 20 mA.  
 Upper:  $V_{DRAIN}$ , 100 V, 5 ms / div.  
 Lower:  $I_{DRAIN}$ , 100 mA / div.



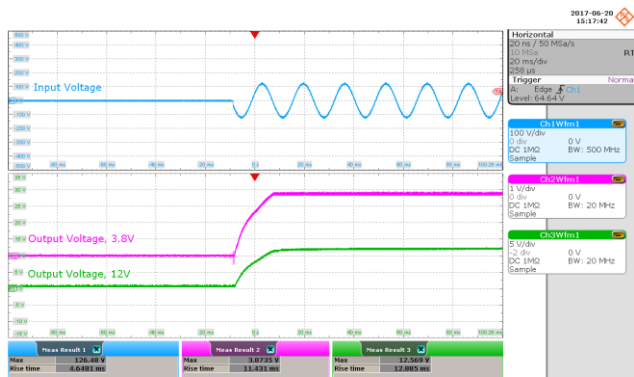
### 11.3.3 Input and Output Voltages Waveforms during Start-up



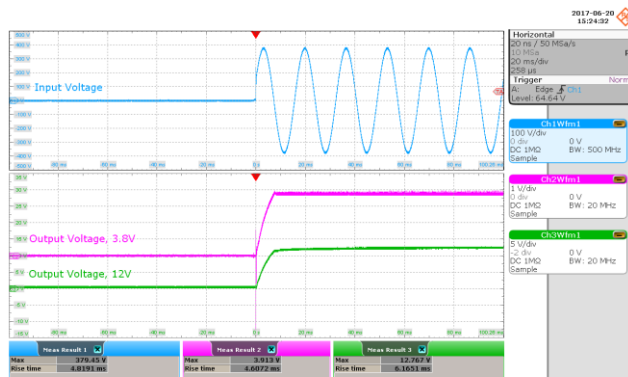
**Figure 37** – 85 VAC Input.  
 Condition: 12 V – 0 A, 3.8 V – 0 A.  
 Upper:  $V_{IN}$ , 100 V, 20 ms / div.  
 Middle:  $V_{OUT1}$ , 1 V / div.  
 Lower:  $V_{OUT2}$ , 5 V / div.



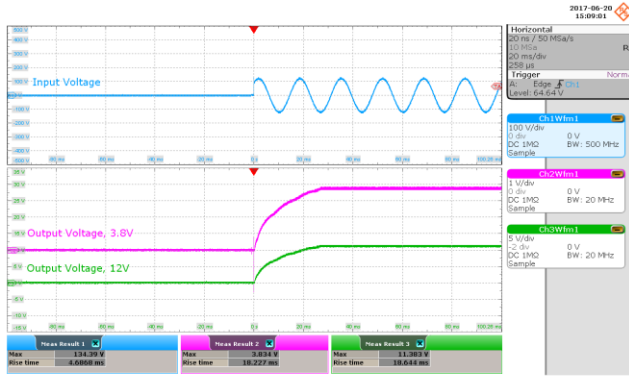
**Figure 38** – 265 VAC Input.  
 Condition: 12 V – 0 A, 3.8 V – 0 A.  
 Upper:  $V_{IN}$ , 100 V, 20 ms / div.  
 Middle:  $V_{OUT1}$ , 1 V / div.  
 Lower:  $V_{OUT2}$ , 5 V / div.



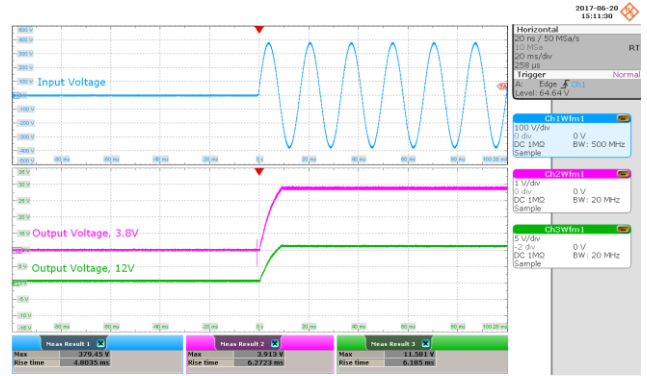
**Figure 39** – 85 VAC Input.  
 Condition: 12 V – 0 A, 3.8 V – 20 mA.  
 Upper:  $V_{IN}$ , 100 V, 20 ms / div.  
 Middle:  $V_{OUT1}$ , 1 V / div.  
 Lower:  $V_{OUT2}$ , 5 V / div.



**Figure 40** – 265 VAC Input.  
 Condition: 12 V – 0 A, 3.8 V – 20 mA.  
 Upper:  $V_{IN}$ , 100 V, 20 ms / div.  
 Middle:  $V_{OUT1}$ , 1 V / div.  
 Lower:  $V_{OUT2}$ , 5 V / div.



**Figure 41** – 85 VAC Input.  
 Condition: 12 V – 0 A, 3.8 V – 20 mA.  
 Upper:  $V_{IN}$ , 100 V, 20 ms / div.  
 Middle:  $V_{OUT1}$ , 1 V / div.  
 Lower:  $V_{OUT2}$ , 5 V / div.

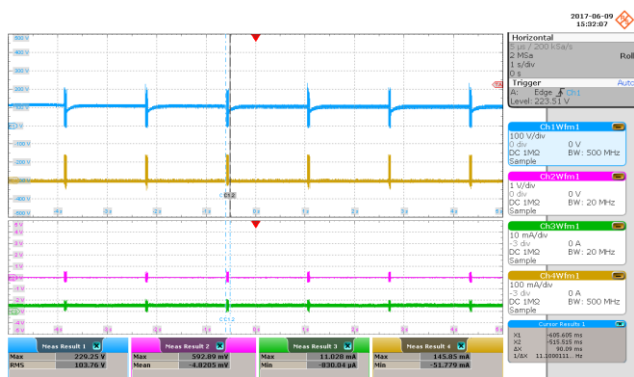


**Figure 42** – 265 VAC Input.  
 Condition: 12 V – 0 A, 3.8 V – 20 mA.  
 Upper:  $V_{IN}$ , 100 V, 20 ms / div.  
 Middle:  $V_{OUT1}$ , 1 V / div.  
 Lower:  $V_{OUT2}$ , 5 V / div.

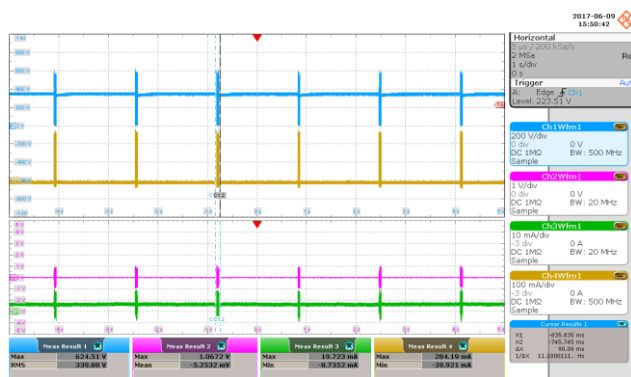


### 11.3.4 Output Short Auto-Restart

Short the main output (3.8 V) and monitor  $V_{DS}$ ,  $I_{DS}$ , output voltage and output current.



**Figure 43 – 85 VAC Input.**  
 Condition: 3.8 V – Shorted, 12 V – 0 mA.  
 Auto-Restart: 91 ms.  
 Upper:  $V_{DS}$ , 100 V / div., 1 s / div.  
 Upper Middle:  $I_{DS}$ , 100 mA / div.  
 Lower Middle:  $V_{OUT3.8}$ , 1 V / div.  
 Lower:  $I_{OUT3.8}$ , 10 mA / div.



**Figure 44 – 265 VAC Input.**  
 Condition: 3.8 V – Shorted, 12 V – 0 mA.  
 Auto-Restart: 91 ms.  
 Upper:  $V_{DS}$ , 200 V / div., 1 s / div.  
 Upper Middle:  $I_{DS}$ , 100 mA / div.  
 Lower Middle:  $V_{OUT3.8}$ , 1 V / div.  
 Lower:  $I_{OUT3.8}$ , 10 mA / div.

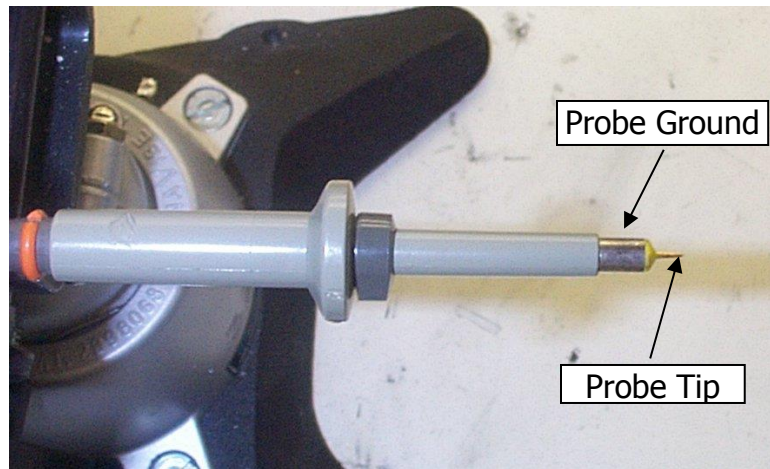
Input Voltage (VAC)	Input Power (mW)
85	60
265	117

## 11.4 Output Ripple Measurements

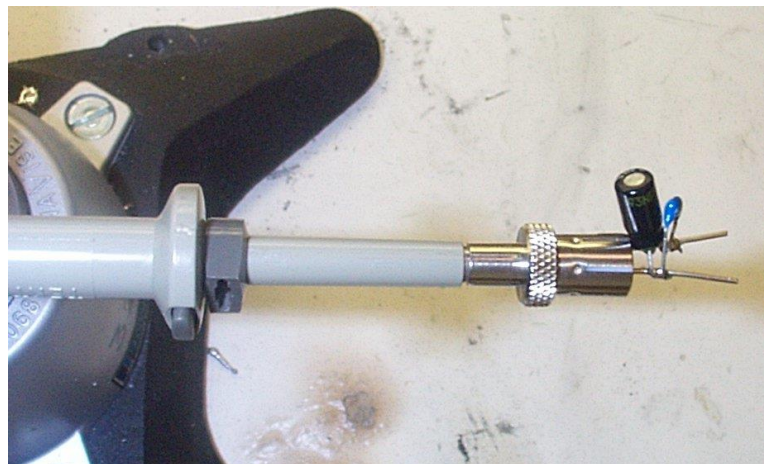
### 11.4.1 Ripple Measurement Technique

For DC output ripple measurements, a modified oscilloscope test probe must be utilized in order to reduce spurious signals due to pick-up. Details of the probe modification are provided in the Figures below.

The 4987BA probe adapter is affixed with two capacitors tied in parallel across the probe tip. The capacitors include one (1) 0.1  $\mu\text{F}/50\text{ V}$  ceramic type and one (1) 47  $\mu\text{F}/16\text{ V}$  aluminum electrolytic. The aluminum electrolytic type capacitor is polarized, so proper polarity across DC outputs must be maintained (see below).



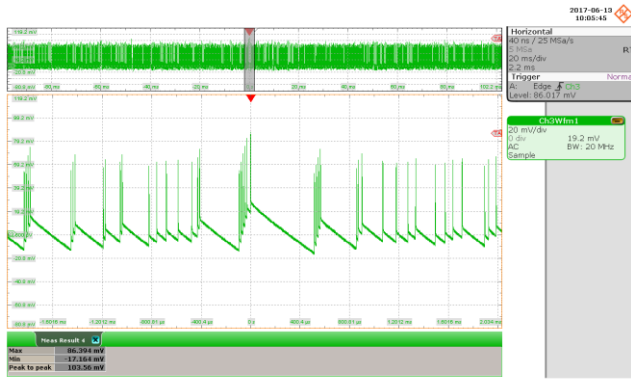
**Figure 45** – Oscilloscope Probe Prepared for Ripple Measurement. (End Cap and Ground Lead Removed)



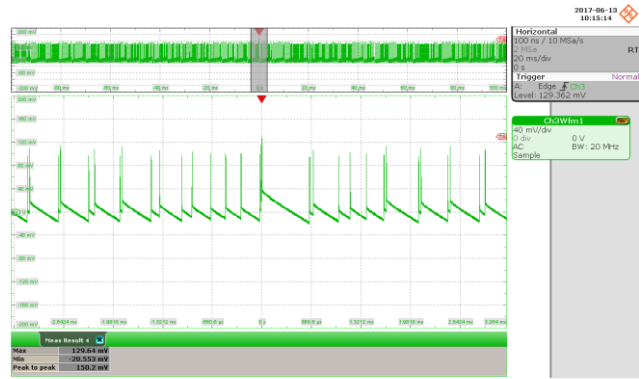
**Figure 46** – Oscilloscope Probe with Probe Master ([www.probemaster.com](http://www.probemaster.com)) 4987A BNC Adapter. (Modified with wires for ripple measurement, and two parallel decoupling capacitors added)

11.4.2 Measurement Results

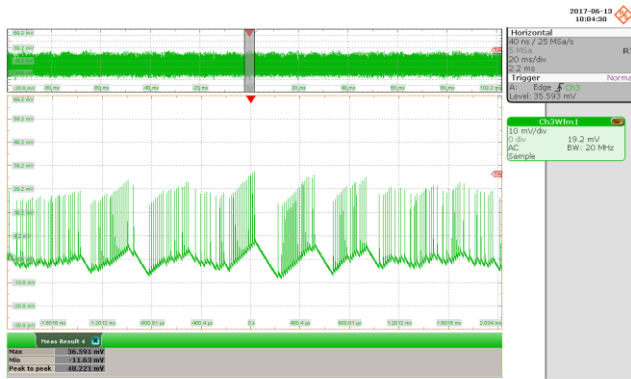
11.4.2.1 Output Ripple Voltage Waveforms for 3.8 V Output



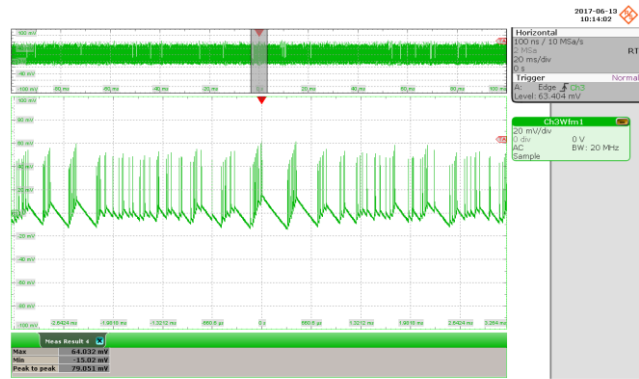
**Figure 47** – 85 VAC Input.  
 Condition: 3.8 V – 20 mA, 12 V – 0 A.  
 $V_{RIPPLE}$ , 20 mV / div., 20 ms, 400  $\mu$ s / div.



**Figure 48** – 265 VAC Input.  
 Condition: 3.8 V – 20 mA, 12 V – 0 A.  
 $V_{RIPPLE}$ , 20 mV / div., 20 ms, 660  $\mu$ s / div.

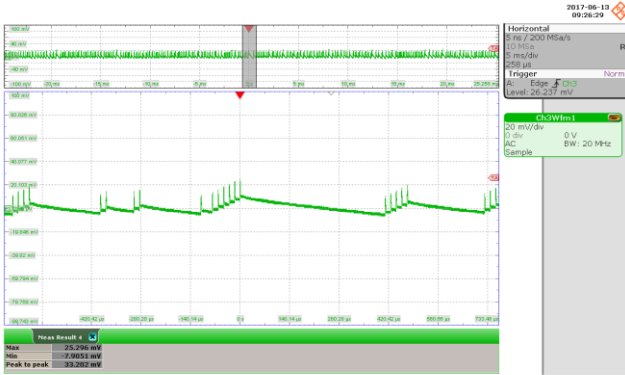


**Figure 49** – 85 VAC Input.  
 Condition: 3.8 V – 20 mA, 12 V – 20 mA.  
 $V_{RIPPLE}$ , 10 mV / div., 20 ms, 400  $\mu$ s / div.

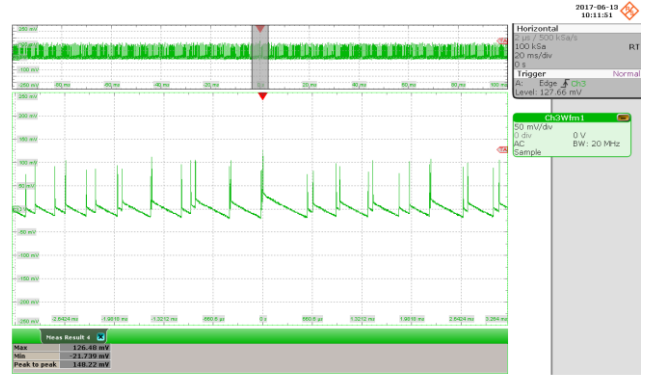


**Figure 50** – 265 VAC Input.  
 Condition: 3.8 V – 20 mA, 12 V – 20 mA.  
 $V_{RIPPLE}$ , 20 mV / div., 20 ms, 660  $\mu$ s / div.

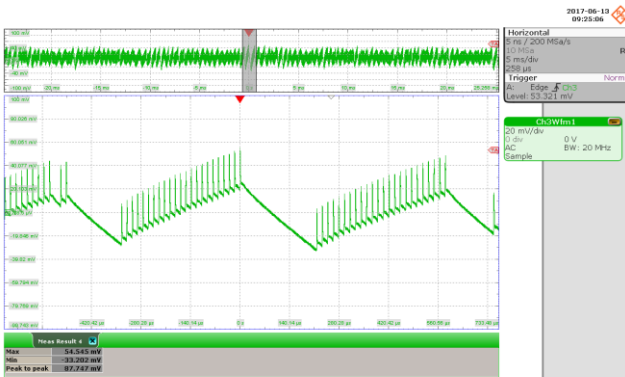
11.4.2.2 Output Ripple Voltage Waveforms for 12 V Output



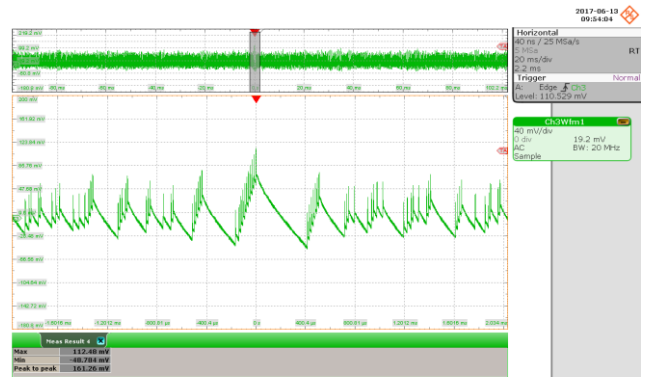
**Figure 51** – 85 VAC Input.  
 Condition: 3.8 V – 20 mA, 12 V – 0 A.  
 $V_{RIPPLE}$ , 20 mV / div., 5 ms, 140  $\mu$ s / div.



**Figure 52** – 265 VAC Input.  
 Condition: 3.8 V – 20 mA, 12 V – 0 A.  
 $V_{RIPPLE}$ , 20 mV / div., 20 ms, 660  $\mu$ s / div.



**Figure 53** – 85 VAC Input.  
 Condition: 3.8 V – 20 mA, 12 V – 20 mA.  
 $V_{RIPPLE}$ , 20 mV / div., 5 ms, 140  $\mu$ s / div.



**Figure 54** – 265 VAC Input.  
 Condition: 3.8 V – 20 mA, 12 V – 20 mA.  
 $V_{RIPPLE}$ , 20 mV / div., 5 ms, 400  $\mu$ s / div.



## 12 Conducted EMI

### 12.1 Test Set-up Equipment

#### 12.1.1 Equipment and Load Used

1. Rohde and Schwarz ENV216 two line V-network.
2. Rohde and Schwarz ESRP EMI test receiver.
3. Hioki 3322 power meter Hi-tester.
4. Chroma measurement test fixture.

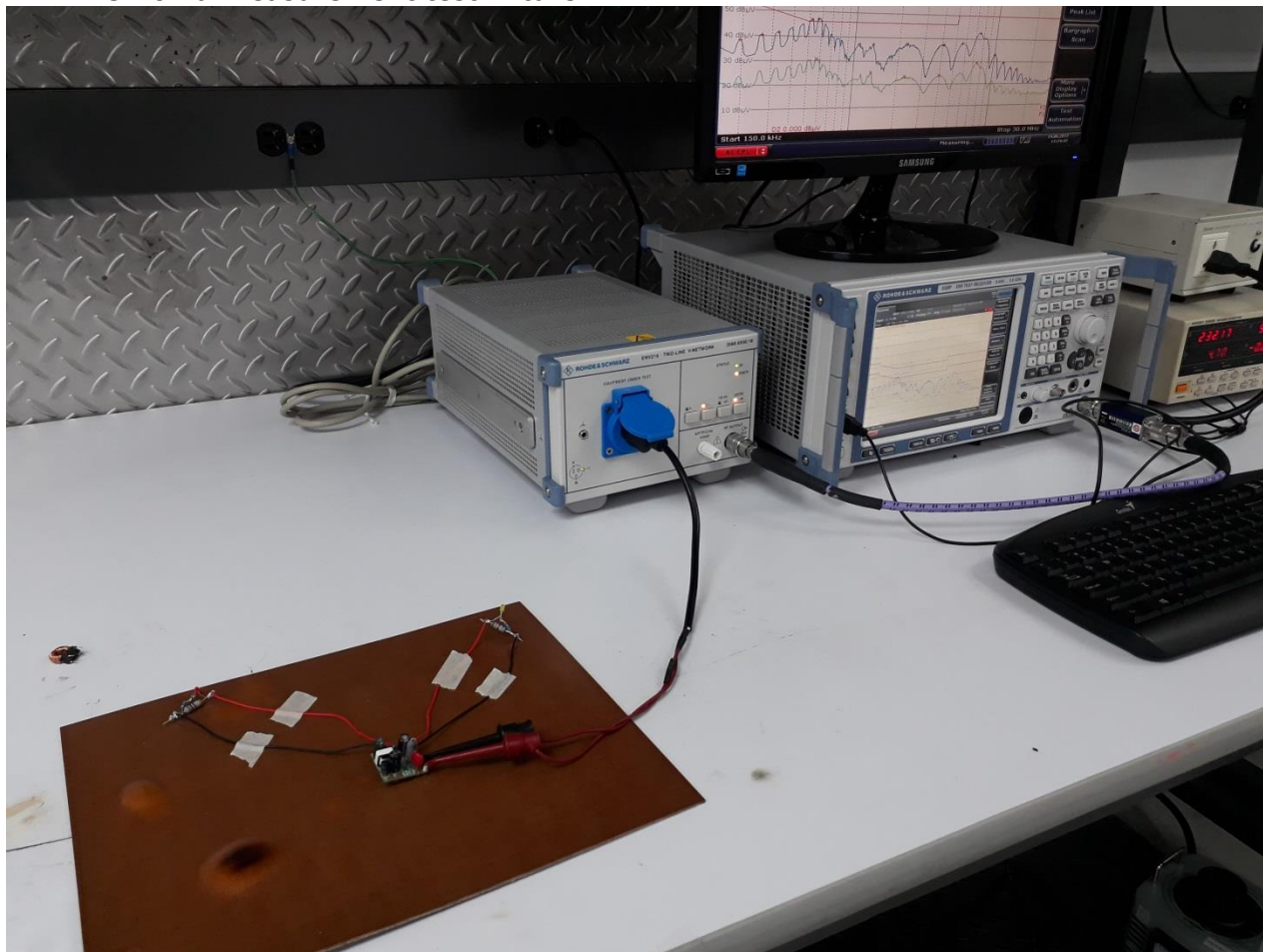


Figure 55 – EMI Test Set-up.



## 12.2 Floating Output (QP / AV)

### 12.2.1 Line 115 VAC (0.3 W, 12 V and 3.8 V Full Load)

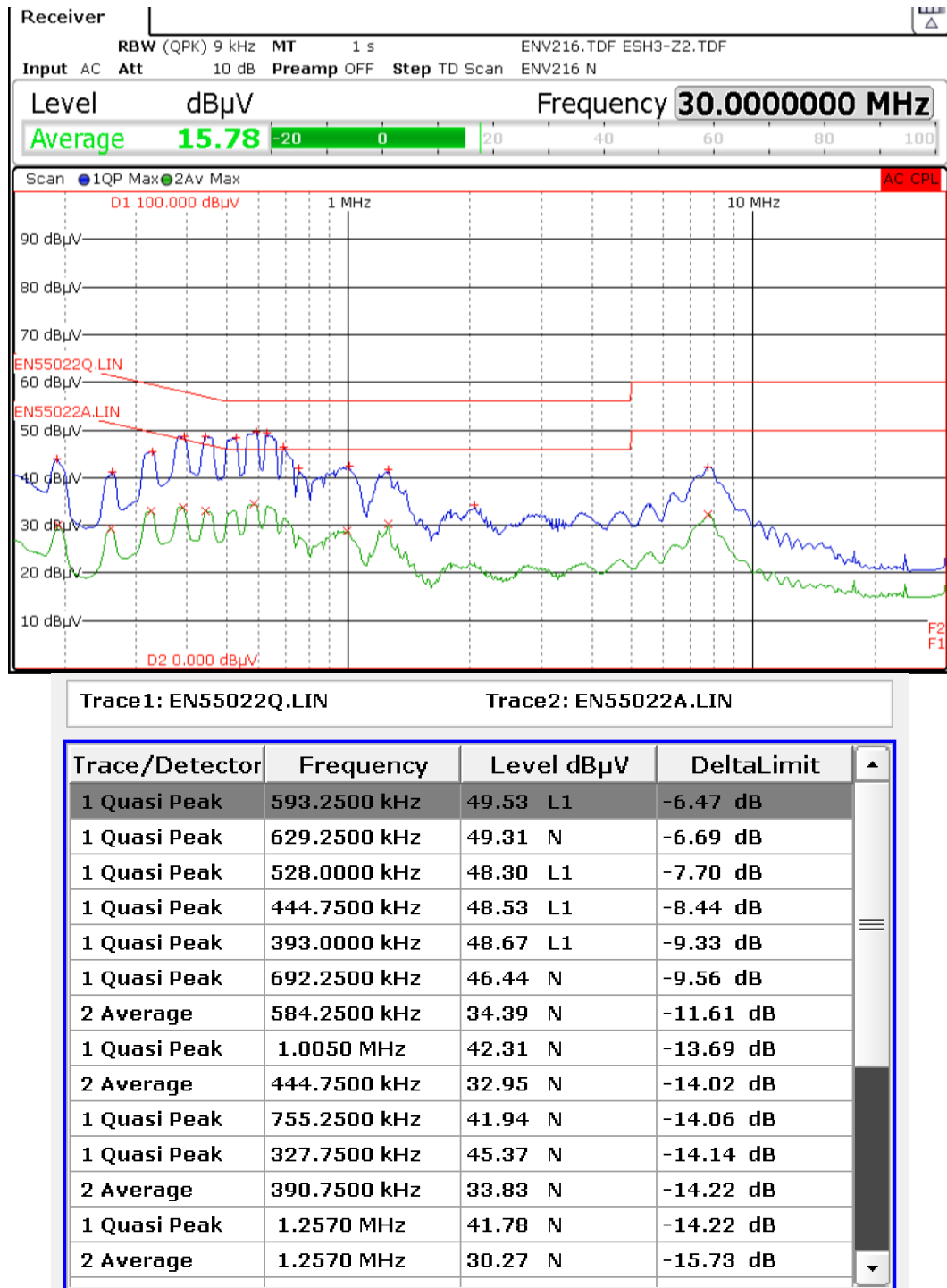


Figure 56 – Floating Negative Output at 115 VAC.

12.2.2 Line 230 VAC (0.3 W, 12 V and 3.8 V Full Load)

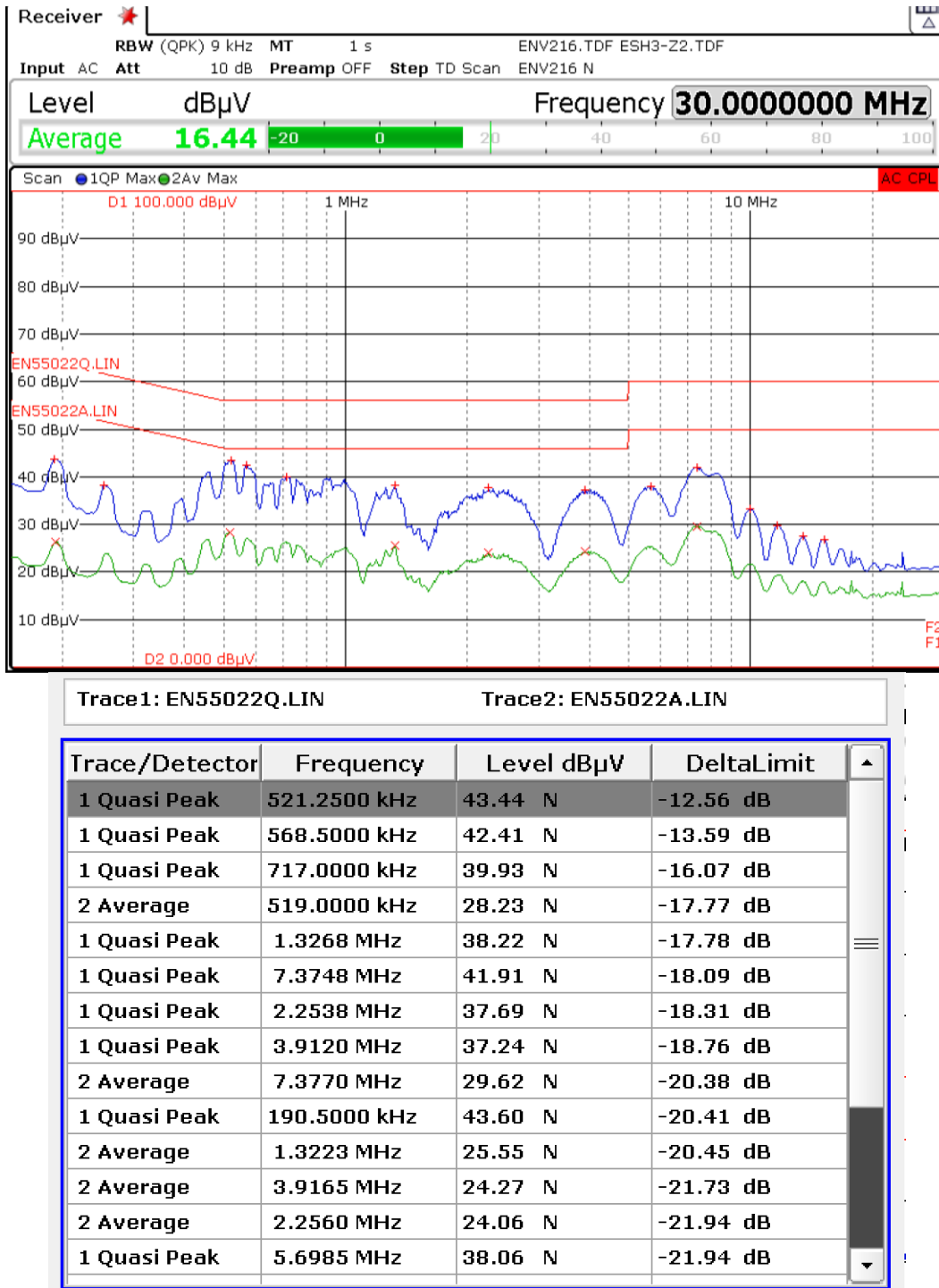


Figure 57 – Floating Negative Output at 230 VAC.

### 13 Lightning Surge Test

The unit was subjected to  $\pm 500$  V, differential surge using 10 strikes at each condition. A test failure was defined as a non-recoverable interruption of output requiring repair or recycling of input voltage.

#### 13.1 Differential Mode Surge Test

The unit passed  $\pm 500$  V (L1/L2) on full load, 20 mA on each output.

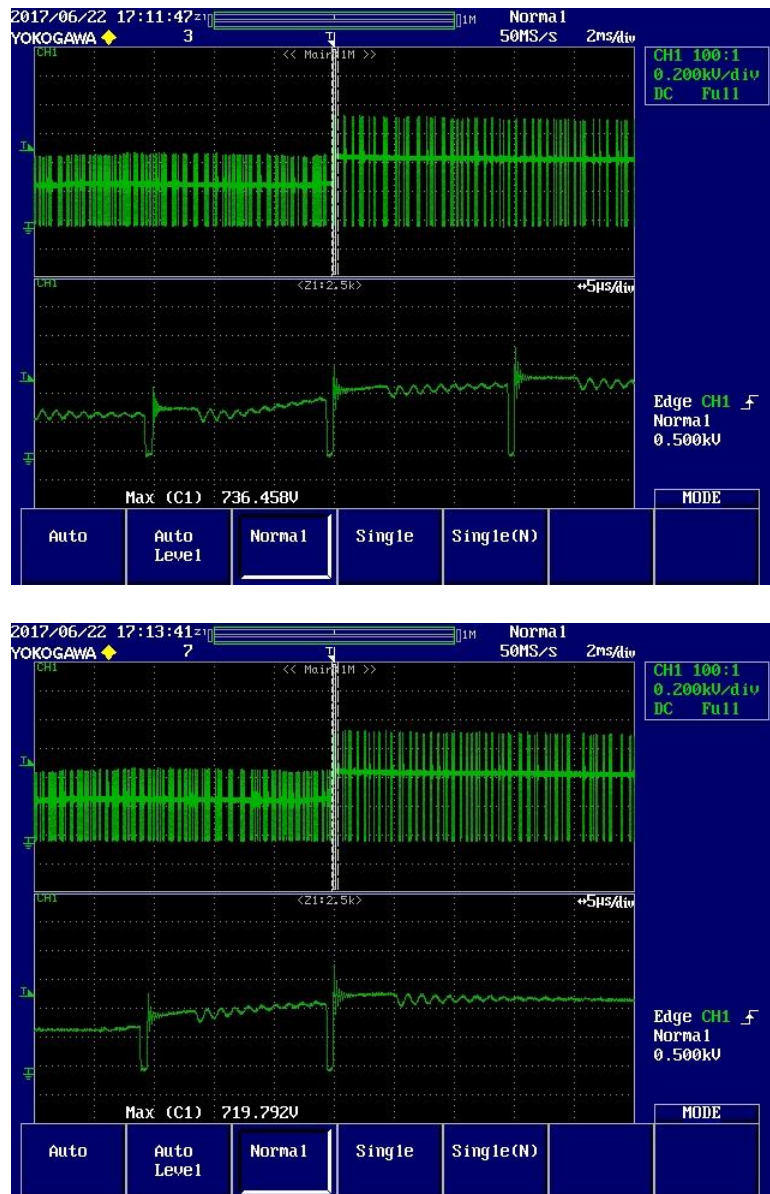


Figure 58 – Differential Mode Surge Test at 500 V.

### 13.2 Ring Wave Surge Test

The unit passed  $\pm 2.5$  kV on full load, 20 mA on each output.

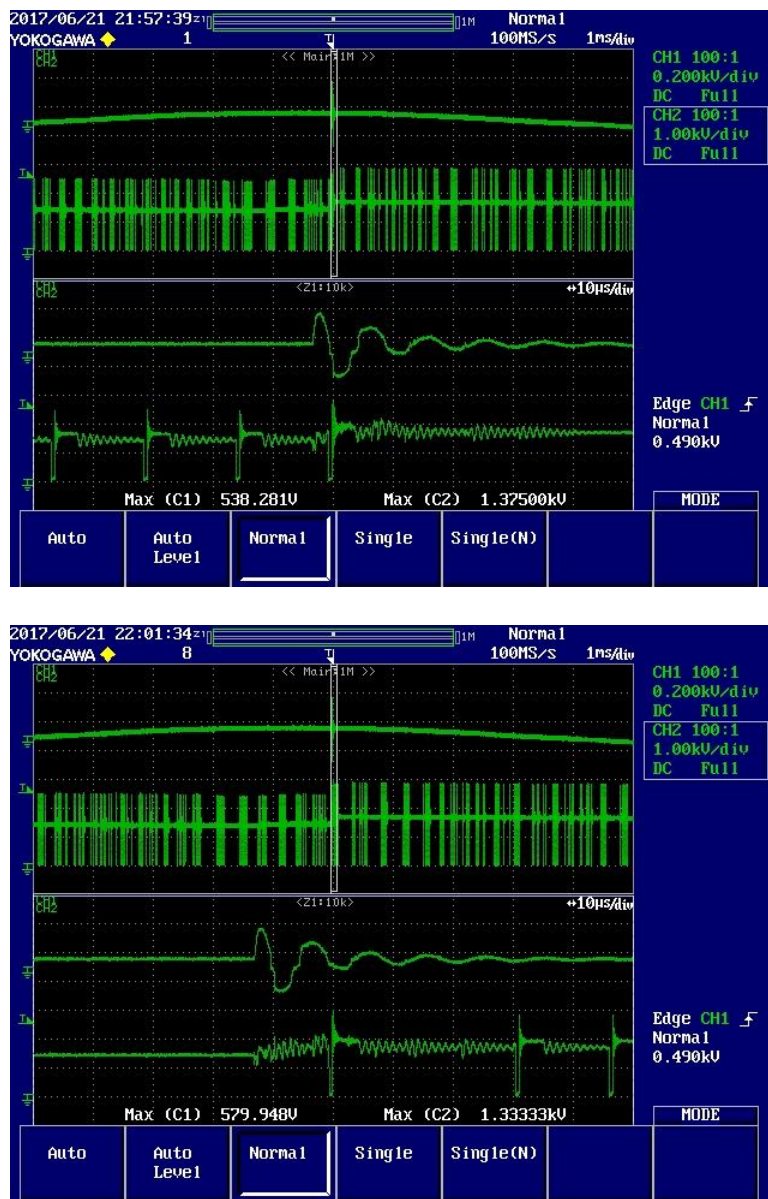


Figure 59 – Ring Wave Surge Test at 2.5 kV.

<b>Ring Wave Voltage (kV)</b>	<b>Phase Angle (°)</b>	<b>Generator Impedance (<math>\Omega</math>)</b>	<b>Number of Strikes</b>	<b>Test Result</b>
2.5	0	5	10	PASS
2.5	90	5	10	PASS
2.5	180	5	10	PASS
2.5	270	5	10	PASS
-2.5	0	5	10	PASS
-2.5	90	5	10	PASS
-2.5	180	5	10	PASS
-2.5	270	5	10	PASS



## 14 Revision History

Date	Author	Revision	Description & Changes	Reviewed
02-Oct-17	DL	1.0	Initial Release.	Mktg & Apps
10-Oct-17	KM	1.1	Updated Figure 10.	
27-Oct-17	KM	1.2	Fixed Schematic Errors.	
02-May-18	KM	1.3	Added Transformer Supplier for T1.	
24-May-18	KM	1.4	Converted DER-623 to RDR-623	

