



Title	<i>Reference Design Report for a 70 W Single-Phase Inverter using BridgeSwitch™ BRD1261C</i>
Specification	180 VAC – 265 VAC Input, 0.35 A _{RMS} Motor Phase Current, 6380 RPM for Electronically Commutated (EC) Centrifugal Fan
Application	High-Voltage Single-Phase Brushless DC (BLDC) Motor for Fan Application
Author	Applications Engineering Department
Document Number	RDR-872
Date	March 23, 2021
Revision	1.1

Summary and Features

- BridgeSwitch – High-voltage half-bridge motor driver
 - Integrated 600 V FREDFETs with ultra-soft, fast recovery diodes
- Inverter efficiency up to 97% using block commutation scheme
- Less than 60 °C package temperature at 29 °C ambient with no external heat sink
- Fully self-biased operation – no auxiliary power supply needed
- Supports low-side external bias operation for low no-load input power
- Integrated high-side and low-side cycle-by-cycle current limit on each BridgeSwitch device
- Instantaneous phase current information output on each BridgeSwitch device
- High-voltage DC bus monitoring with four undervoltage and one overvoltage thresholds
- Two-level device over-temperature protection
- Single-wire status update communication bus

PATENT INFORMATION

The products and applications illustrated herein (including transformer construction and circuits external to the products) may be covered by one or more U.S. and foreign patents, or potentially by pending U.S. and foreign patent applications assigned to Power Integrations. A complete list of Power Integrations' patents may be found at www.power.com. Power Integrations grants its customers a license under certain patent rights as set forth at <https://www.power.com/company/intellectual-property-licensing/>.

Power Integrations

5245 Hellyer Avenue, San Jose, CA 95138 USA.
Tel: +1 408 414 9200 Fax: +1 408 414 9201
www.power.com

Table of Contents

1	Introduction	4
2	Inverter Specification.....	5
3	Schematic.....	6
4	Circuit Description	7
4.1	Input Stage.....	7
4.2	Single-Phase BridgeSwitch Inverter.....	7
4.2.1	Self-Supply Operation.....	7
4.2.2	Control Inputs.....	8
4.2.3	Cycle-by-Cycle Current Limit.....	8
4.2.4	Instantaneous Phase Current Information	8
4.2.5	High-Voltage DC Bus Monitoring	8
4.2.6	External System Monitor.....	8
4.2.7	Status Communication Bus	8
4.2.8	Interface Connector	9
5	Printed Circuit Board Layout.....	10
6	Bill of Materials	11
7	Performance Data	12
7.1	Efficiency	12
7.2	No-Load Input Power.....	14
7.3	Thermal Performance.....	15
7.4	Start-Up Operation	17
7.5	Steady-State Operation.....	18
7.5.1	Phase Current During Steady-State	18
7.5.2	Half-Bridge Voltages During Steady-State.....	19
7.5.3	/INH and INL Input Signals During Steady-State.....	20
7.5.4	Bypass Pin Voltages During Steady-State.....	21
7.5.5	Phase Current Information Output (IPH)	22
7.5.6	FREDFET Drain Voltage Slew Rate at Full Load	23
8	Device and System Level Protection and Monitoring	24
8.1	Integrated Cycle-by-Cycle Current Limit	24
8.2	Two-level Device Over-Temperature Protection	25
8.3	High-Voltage DC Bus Monitoring.....	26
8.3.1	Undervoltage Thresholds.....	26
8.3.2	Overvoltage Threshold	28
9	Abnormal Motor Operation.....	29
9.1	Motor Stall Conditions	29
9.2	Motor Overload During Operation	31
9.3	Motor Winding Disconnect During Operation	32
10	Appendix	33
10.1	Inverter Circuit Board Manual.....	33
10.2	Status Word Encoding.....	35
10.3	Test Bench Set-up	36
10.4	Inverter Output Power Measurement	37



10.5 Current Capability and Ambient Temperature38
11 Revision History39

Important Note:

During operation, the reference design board is subject to hazards including high voltages, rotating parts, bare wires, and hot surfaces. Energized DC bus capacitors require time to discharge after DC input disconnection.

All testing should use an isolation transformer to provide the AC input to the board.



1 Introduction

This document is an engineering report describing a 70 W, 97% efficient, single-phase inverter for a high-voltage single-phase brushless DC (BLDC) motor application using BridgeSwitch motor driver IC. The single-phase BLDC motor is driven up to 0.35 A_{RMS} phase current and an operational speed of up to 6380 RPM.

The single-phase inverter is implemented using two fully integrated BridgeSwitch (BRD1261C) devices in a small footprint surface mount package with exposed pads that enables heat dissipation through the PCB itself.

The design demonstrates the device performance, internal fault protections and system level monitoring enabled by the high level of integration of the BridgeSwitch half-bridge motor driver. It utilizes a simple control interface that incorporates the inverter control inputs, instantaneous phase current information signals and a single-wire status update communication bus. It also features an optional external supply input for externally-biased operation of the low-side bypass capacitors for low no-load input power consumption.

This document contains the inverter and motor specifications, schematic, bill of materials (BOM), printed circuit board (PCB) layout, performance data, inverter manual, and inverter test bench setup.

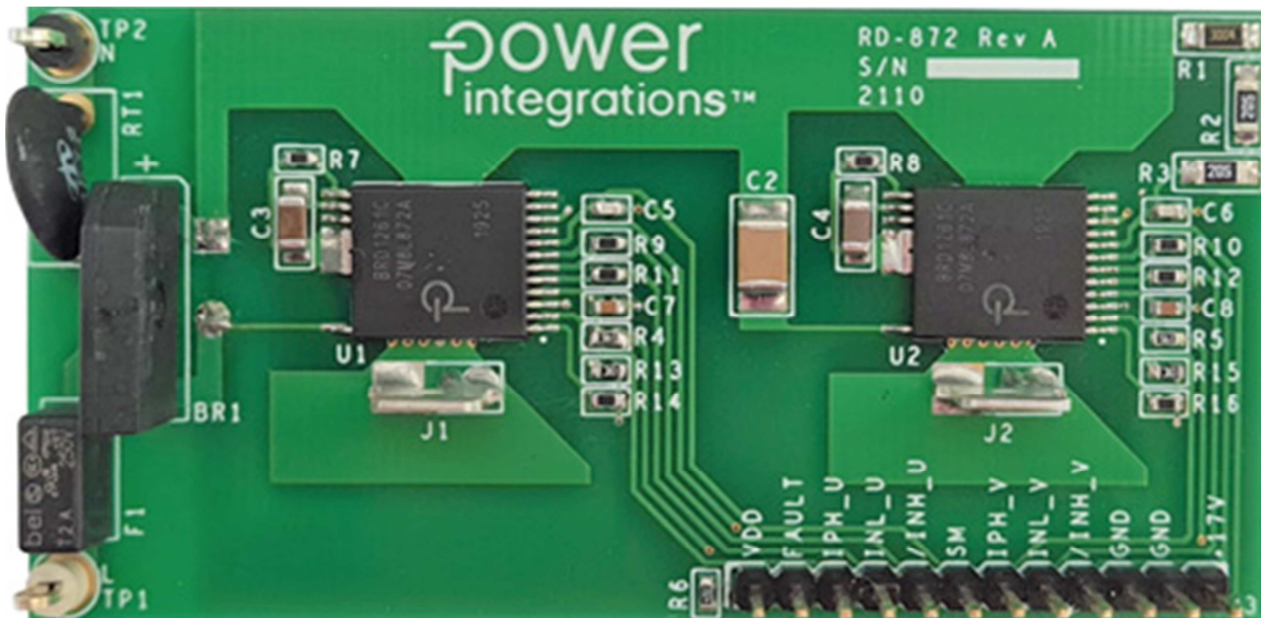

Figure 1 – Populated Circuit Board Photograph.

2 Inverter Specification

The table below provides the electrical specification of the single-phase inverter design. The results section provides actual performance data.

Description	Symbol	Min	Typ	Max	Units	Comment
Input						
Voltage	V_{IN}	180	230	265	VAC	2 Wire – no P.E.
Frequency	f_{LINE}	47	50/60	64	Hz	
Power	P_{IN}		72.2		W	Inverter Input.
Output						
Power	P_{OUT}		70		W	Inverter Output.
Motor Phase Current	I_{MOTOR}		0.35		A _{rms}	RMS Phase Current.
Output Speed	ω		6380		RPM	Motor Speed at 70W Inverter Output Power.
PWM Carrier Frequency	f_{PWM}		10		kHz	
Efficiency						
Full load	η		97		%	Inverter Efficiency at 70W Inverter Output Power in Self-Supplied Operation.
DC Bus Sensing¹						
OV Threshold	V_{OV}		422		V	Reported Through Status Communication Bus.
1 st UV Threshold	V_{UV100}		247		V	
2 nd UV Threshold	V_{UV85}		212		V	
3 rd UV Threshold	V_{UV70}		177		V	
4 th UV Threshold	V_{UV55}		142		V	
Overcurrent Protection²						
Internal HS / LS FREDFET Overcurrent Threshold	$I_{LIM(DEF)}$		1.5		A	BridgeSwitch BRD1261C Default Current Limit.

Notes:

¹ Externally programmable through SM pin sensing resistor

² Externally programmable through XL/XH pin resistors (1.5 A default current limit at 44.2 k Ω)

Table 1 – RD-872 Single-Phase Inverter Specifications.

3 Schematic

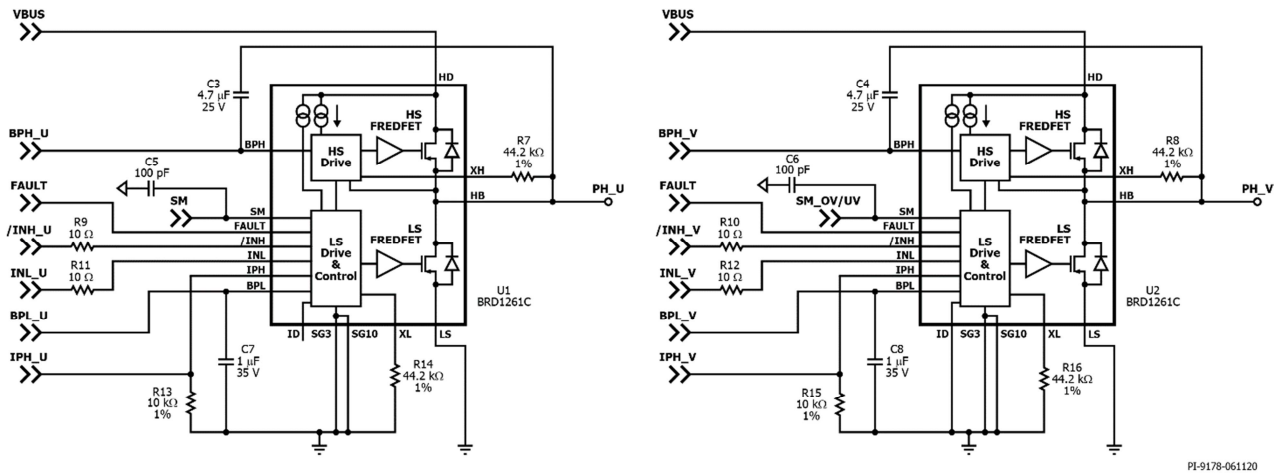

Figure 2 – BridgeSwitch Single-Phase Inverter Schematic.

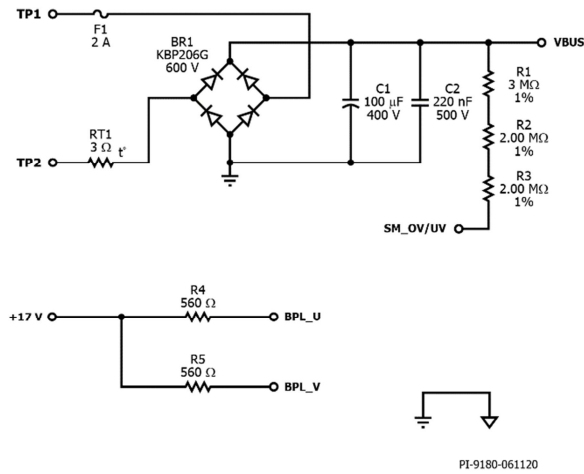

Figure 3 – Input Stage and External Bias Schematic.

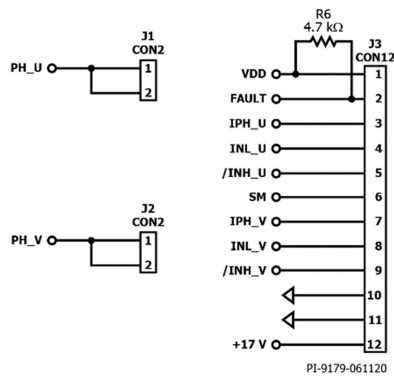

Figure 4 – Motor Phase and Controller Connector Schematic.

4 Circuit Description

The schematic shows a single-phase inverter utilizing two BridgeSwitch devices. The circuit design drives a high-voltage, single-phase brushless DC (BLDC) motor with Hall sensors. BridgeSwitch integrates two 600 V, N-channel power FREDFETs with corresponding gate drives into a low-profile surface mount package. The BridgeSwitch power FREDFET features ultra-soft, fast recovery diode ideally suited for inverter drives. Both drivers are fully self-supplied thus eliminating the need for an auxiliary power supply.

In addition, BridgeSwitch incorporates internal fault protection and system level monitoring. Internal fault protection includes cycle-by-cycle current limit for both FREDFETs and a two-level thermal overload protection. On the other hand, system level monitoring includes high-voltage DC bus sensing with multi-level undervoltage thresholds and one overvoltage threshold. BridgeSwitch can also be configured using external sensors such as a thermistor for system temperature monitoring. A single-wire open-Drain bus communicates all detected faults or change of status to the system microcontroller.

4.1 *Input Stage*

The input stage consists of fuse F1, bridge diode BR1, inrush thermistor RT1, and input capacitor C1. Fuse F1 provides protection when there is an excessive input current. Bridge diode BR1 is used for input rectification and circuit protection in case the polarity of the input bus voltage is reversed. Thermistor RT1 is a negative temperature coefficient (NTC) device that initially presents a high resistance, which prevents large currents from flowing during turn-on therefore limiting inrush current. A bulk capacitor C1 is used for high input bus voltage.

4.2 *Single-Phase BridgeSwitch Inverter*

The two BridgeSwitch (BRD1261C) devices U1 and U2 form the single-phase inverter with the output of the inverter connected to the single-phase BLDC motor through connectors J1 and J2.

4.2.1 Self-Supply Operation

Capacitors C7 and C8 provide self-supply decoupling for the integrated low-side controller and gate driver. Internal high-voltage current sources charge C7 and C8. On the other hand, capacitors C3 and C4 provide self-supply decoupling for the integrated high-side controller and gate driver. Internal high-voltage current sources recharge C3 and C4 whenever the half-bridge voltage level of the respective device drops to the low-side source voltage level (i.e. the low-side FREDFET turns on).

4.2.2 Control Inputs

Control input signals INL_U, /INH_U, and INL_V, /INH_V control the switching state of the integrated high-side and low-side power FREDFETs. The system microcontroller provides the required control input signals through pins 4, 5, 8, and 9 of the male header connector J3. The BridgeSwitch devices are compatible with 3.3 V and 5 V logic level control input signals. Series gate resistors R9, R10, R11, and R12 keep the signal integrity of these control signals.

4.2.3 Cycle-by-Cycle Current Limit

Resistor R7, R8, R14, and R16 set the cycle-by-cycle current limit level for the integrated low-side and high-side power FREDFETs. A selected value of 44.2 k Ω set the current limit to 100% of the default level. The BRD1261C device default current limit, $I_{LIM(DEF)}$, is defined as 1.5 A typical with a di/dt value of 250 mA/ μ s.

4.2.4 Instantaneous Phase Current Information

The BridgeSwitch devices provide instantaneous phase current information of the low-side FREDFET Drain to Source current through the IPH pin output across resistors R13 and R15. The IPH pin output signals IPH_U and IPH_V of device U1 and U2 are available at pins 3 and 7 of the male header connector J3.

4.2.5 High-Voltage DC Bus Monitoring

BridgeSwitch device U2 monitors the DC input voltage through resistors R1, R2, and R3. The combined resistance of 7 M Ω sets four levels of undervoltage thresholds at 247 V, 212 V, 177 V, and 142 V. The overvoltage threshold is at 422 V. Capacitor C6 provides additional high frequency noise filtering at the SM pin of device U2.

4.2.6 External System Monitor

BridgeSwitch device U1 provides optional system monitor through its own SM pin. It can be configured as a system temperature sense with an external thermistor. Capacitor C5 provides additional high frequency noise filtering at the SM pin of device U1. The external system monitor input is available at pin 6 of the male header connector J3.

4.2.7 Status Communication Bus

The BridgeSwitch devices U1 and U2 report any detected internal and system status change through the communication bus (FAULT) connected to pin 2 of the male header connector J3. The two FAULT pins of the BridgeSwitch devices are tied together to form a single-wire bus. The status communication bus is an open-Drain architecture and the pull-up resistor R6 provides a pull-up supply to VDD at pin 1 of the male header connector J3.

4.2.7.1 Device ID

Each BridgeSwitch device assigns itself a unique device ID through the connection of pin 11 (ID pin). The pin connection can either be floating, connected to the SG pin or BPL pin. Device ID enables communication of faults from the actual devices to the system microcontroller. The ID pin of BridgeSwitch device U1 is configured to floating and corresponds to a t_{ID} of 60 μ s while the ID pin of BridgeSwitch device U2 is shorted to SG and corresponds to a t_{ID} of 80 μ s.

4.2.8 Interface Connector

The 12-position male header connector J3 interfaces with the system microcontroller for the control inputs, instantaneous phase current information, optional external system monitor and status communication bus.

4.2.8.1 External Supply

The 12-position male header connector J3 also provides an optional external supply input for the low-side bypass capacitors of the BridgeSwitch devices. It is available at pin 12 of the male header connector J3. A single input rail of 17 VDC is recommended to achieve low no-load input power consumption.

5 Printed Circuit Board Layout

PCB thickness is 0.062 inches with a copper thickness of 2 ounces.

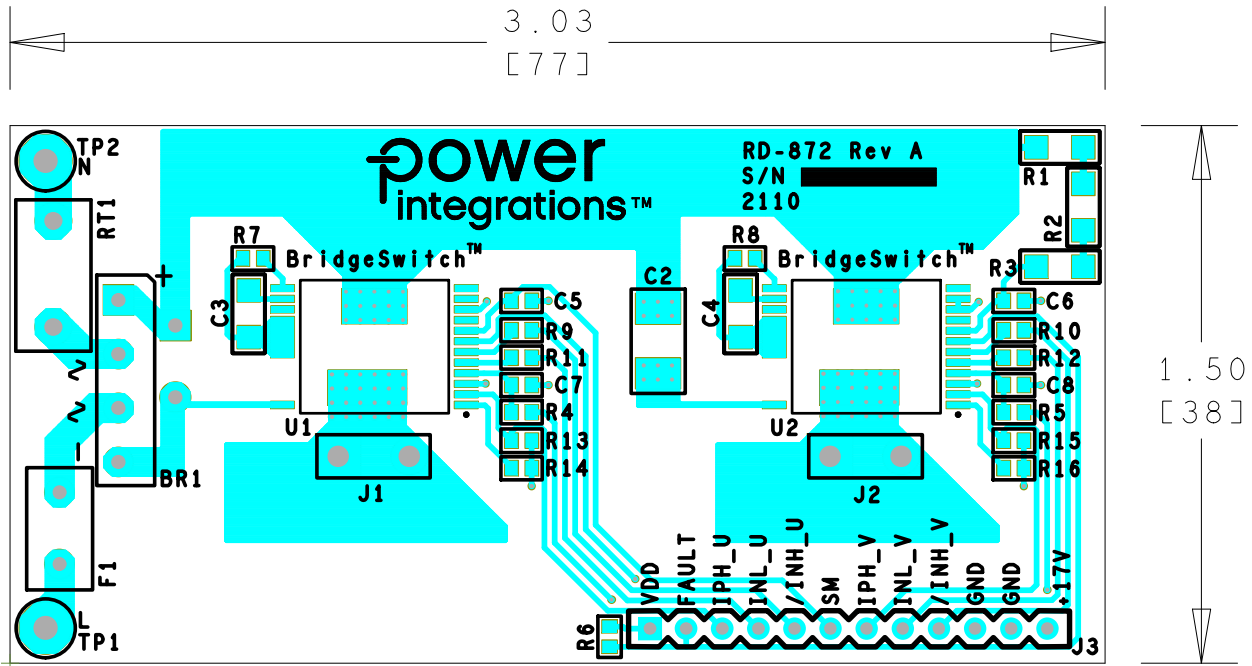

Figure 5 – Printed Circuit Layout, Top.

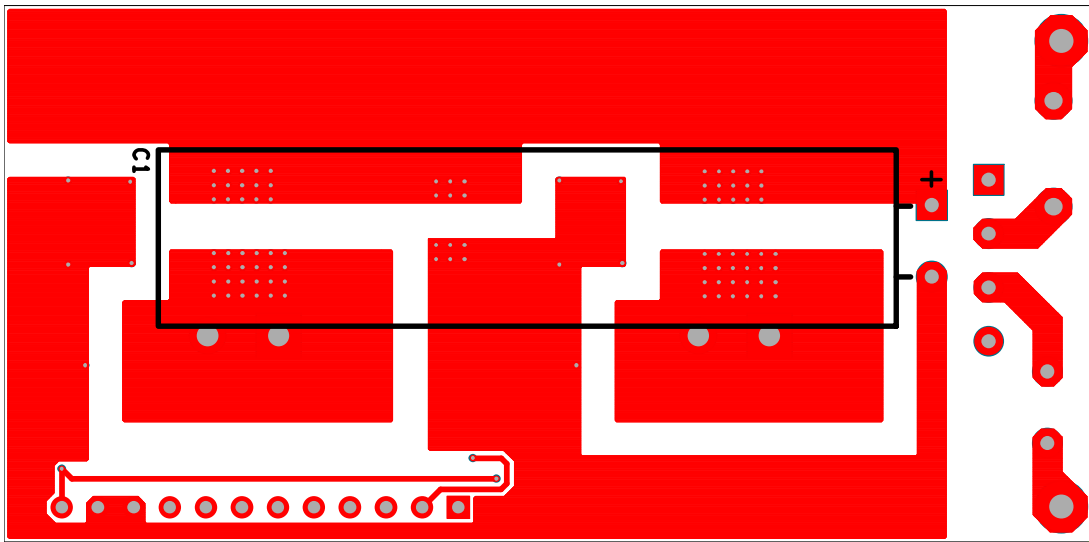

Figure 6 – Printed Circuit Layout, Bottom.

6 Bill of Materials

Item	Qty	Ref Des	Description	Mfg Part Number	Mfg
1	1	BR1	BRIDGE RECT, 1PHASE, 600 V, 2 A, 4-SIP, KBP	KBP206G	Diodes, Inc.
2	1	C1	100 μ F, \pm 20%, 400 V, Aluminum Electrolytic Radial, Can 12000 Hrs @ 105°C (12.5 x 52)	400BXW100MEFR12.5X50	Rubycon
3	1	C2	220 nF, 500 V, Ceramic, X7R, 1812	C1812C224KCRCTU	Kemet
4	2	C3 C4	4.7 μ F, \pm 10%, 25 V, Ceramic, X7R, 1206	GCM31CR71E475KA55L	Murata
5	2	C5 C6	100 pF 200 V, Ceramic, NP0, 0603	C0603C101J2GAC7867	Kemet
6	2	C7 C8	1 μ F, \pm 10%, 35V, Ceramic, X7R, 0603	C1608X7R1V105K080AE	TDK
7	1	F1	2 A, 250 V, Slow, Long Time Lag, RST	RST 2	Belfuse
8	2	J1 J2	CONN QC TAB 0.250 SOLDER	1287-ST	KeyStone
9	1	J3	12 Position (1 x 12) Male header, 0.1 pitch, 0.126" (3.20 mm), Vertical, Au	PRPC012SFAN-RC	Sullins Connector
10	1	R1	RES, 3 M Ω , 1%, 1/4 W, Thick Film, 1206	KTR18EZPF3004	Rohm
11	2	R2 R3	RES, 2.00 M Ω , 1%, 1/4 W, Thick Film, 1206	ERJ-8ENF2004V	Panasonic
12	2	R4 R5	RES, 560 Ω , 5%, 1/10 W, Thick Film, 0603	ERJ-3GEYJ561V	Panasonic
13	1	R6	RES, 4.7 k Ω , 5%, 1/10 W, Thick Film, 0603	ERJ-3GEYJ472V	Panasonic
14	4	R7 R8 R14 R16	RES, 44.2 k Ω , 1%, 1/16 W, Thick Film, 0603	ERJ-3EKF4422V	Panasonic
15	4	R9 R10 R11 R12	RES, 10 Ω , 5%, 1/10 W, Thick Film, 0603	ERJ-3GEYJ100V	Panasonic
16	2	R13 R15	RES, 10.0 k Ω , 1%, 1/16 W, Thick Film, 0603	ERJ-3EKF1002V	Panasonic
17	1	RT1	NTC Thermistor, 4 Ω , 5 A	MF72-003D11	Cantherm
18	1	TP1	Test Point, WHT, THRU-HOLE MOUNT	5012	Keystone
19	1	TP2	Test Point, BLK, THRU-HOLE MOUNT	5011	Keystone
20	2	U1 U2	BridgeSwitch, Full Featured, Max. BLDC Motor Current 1.7 A (DC)	BRD1261C	Power Integrations

7 Performance Data

This section presents waveform plots and performance data of the BridgeSwitch single-phase inverter. An input voltage of 325 VDC was applied directly across the input capacitor C1 and the single-phase inverter is in self-supplied operation unless stated otherwise. Consequently, the fuse F1, inrush thermistor RT1 and bridge diode BR1 were disabled during operation and measurement. An external supply voltage of 17 VDC was applied to achieve externally-supplied low-side capacitor operation. Full-load operation describes the inverter operating 0.35 A_{RMS} motor phase current, 6380 RPM, and 10 kHz PWM switching frequency using block commutation. All measurements were performed at 29 °C room ambient temperature.

7.1 Efficiency

The single-phase inverter efficiency was measured using DC input power at 325 VDC applied directly across input capacitor C1 and respective inverter RMS output power in self-supplied and externally-supplied operation.

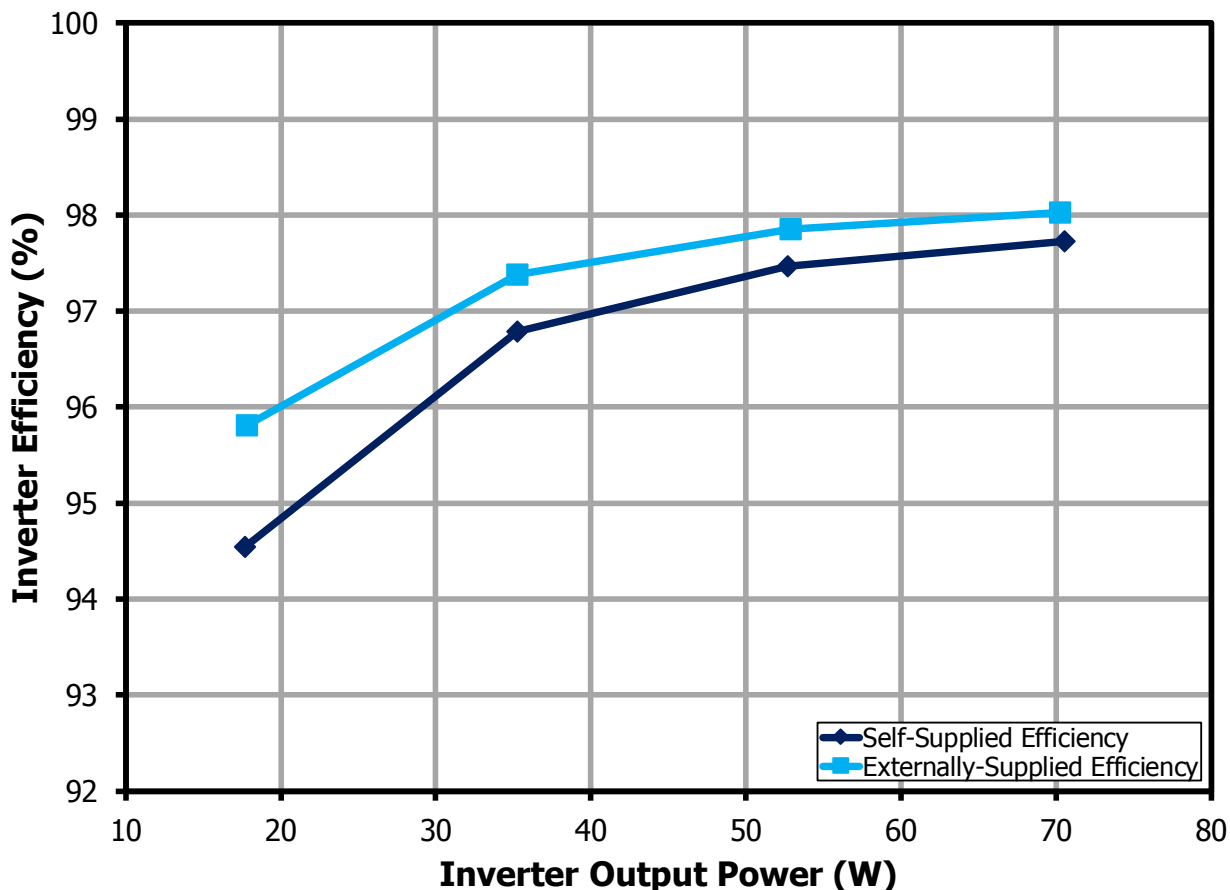

Figure 7 – BRD1261C Single-Phase Inverter Efficiency.

DC Input Voltage (V)	Speed (RPM)	DC Input Power (W)	Motor RMS Phase Voltage (V)	Motor RMS Phase Current (mA)	Inverter Output Power (W)	Inverter Efficiency (%)
325.35	6380	72.20	303.35	354.29	70.56	97.73
325.37	5820	54.07	269.43	291.60	52.70	97.47
325.36	5030	36.44	230.73	245.74	35.27	96.79
325.38	3870	18.70	181.83	206.37	17.68	94.54

Table 2 – Single-phase inverter efficiency data in self-supplied operation

DC Input Voltage (V)	Speed (RPM)	DC Input Power (W)	Motor RMS Phase Voltage (V)	Motor RMS Phase Current (mA)	Inverter Output Power (W)	Inverter Efficiency (%)
325.36	6380	71.65	302.08	352.12	70.24	98.03
325.39	5820	54.01	269.46	292.50	52.85	97.85
325.38	5030	36.20	230.17	246.71	35.25	97.38
325.40	3870	18.61	182.35	206.78	17.83	95.81

Table 3 – Single-phase inverter efficiency data in externally-supplied operation.

7.2 *No-Load Input Power*

The single-phase inverter no-load input power was measured across different DC input voltages (255, 285, 325, and 375 VDC) applied directly across the input capacitor C1 corresponding to the following AC input voltages (180, 200, 230, and 265 VAC) in self-supplied and externally-supplied operation.

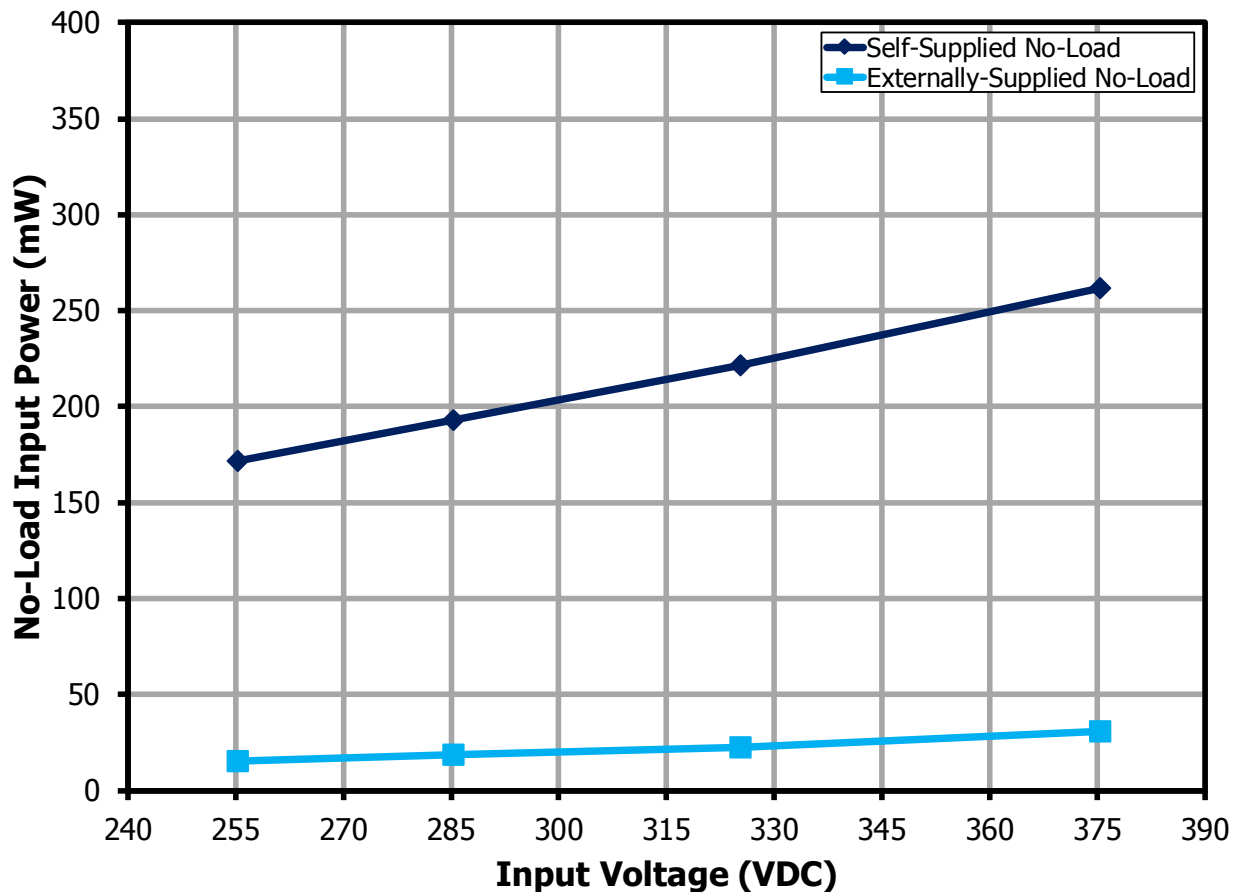

Figure 8 – No-Load Input Power.

7.3 Thermal Performance

The single-phase inverter thermal performance was measured using the DC input power at 325 VDC applied directly across the input capacitor C1 during half-load (35 W) and full-load (70 W) output power in self-supplied and externally-supplied operation at 29 °C room ambient temperature.

Single-phase inverter thermal scan in self-supplied operation.

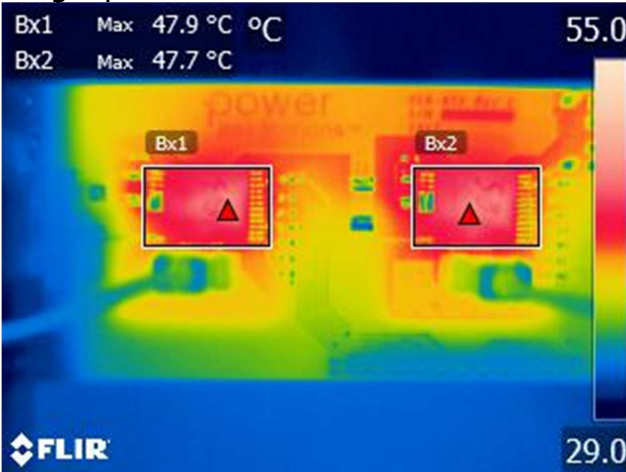

Figure 9 – 35 W Inverter Output Power.
Bx1: Half-Bridge U: 47.9 °C.
Bx2: Half-Bridge V: 47.7 °C.

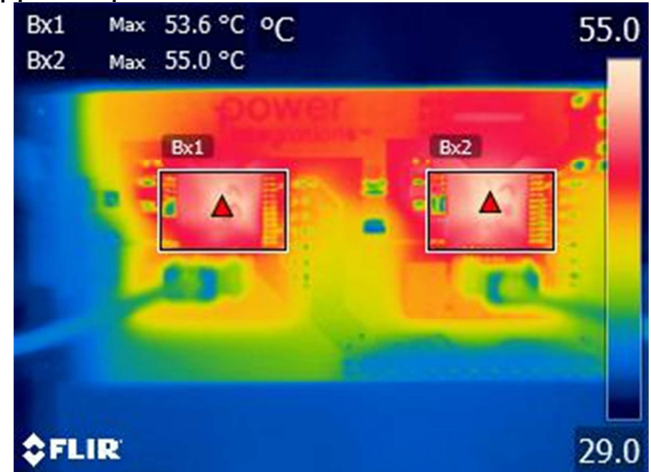

Figure 10 – 70 W Inverter Output Power.
Bx1: Half-Bridge U: 53.6 °C.
Bx2: Half-Bridge V: 55.0 °C.

Single-phase inverter thermal scan in externally-supplied operation.

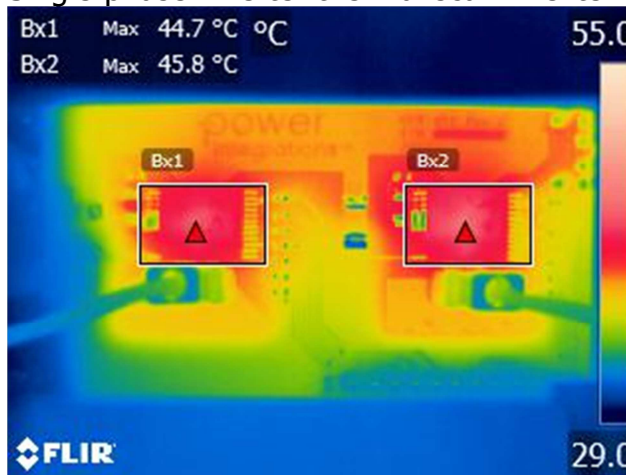

Figure 11 – 35 W Inverter Output Power.
Bx1: Half-Bridge U: 44.7 °C.
Bx2: Half-Bridge V: 45.8 °C.

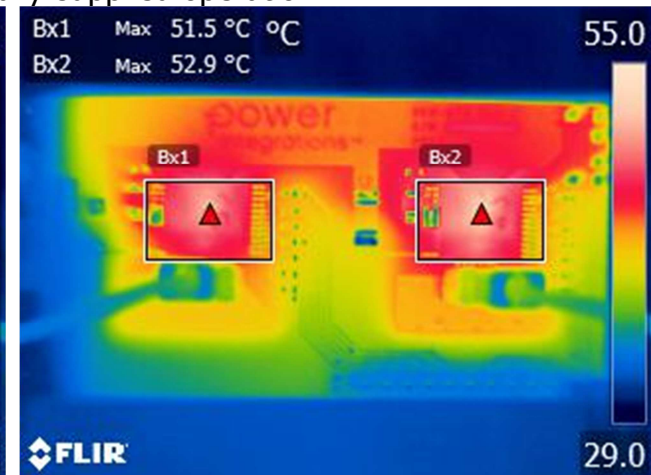

Figure 12 – 70 W Inverter Output Power.
Bx1: Half-Bridge U: 51.5 °C.
Bx2: Half-Bridge V: 52.9 °C.

The maximum device case temperature rise above the room ambient temperature in self-supplied and externally-supplied operation is illustrated below.

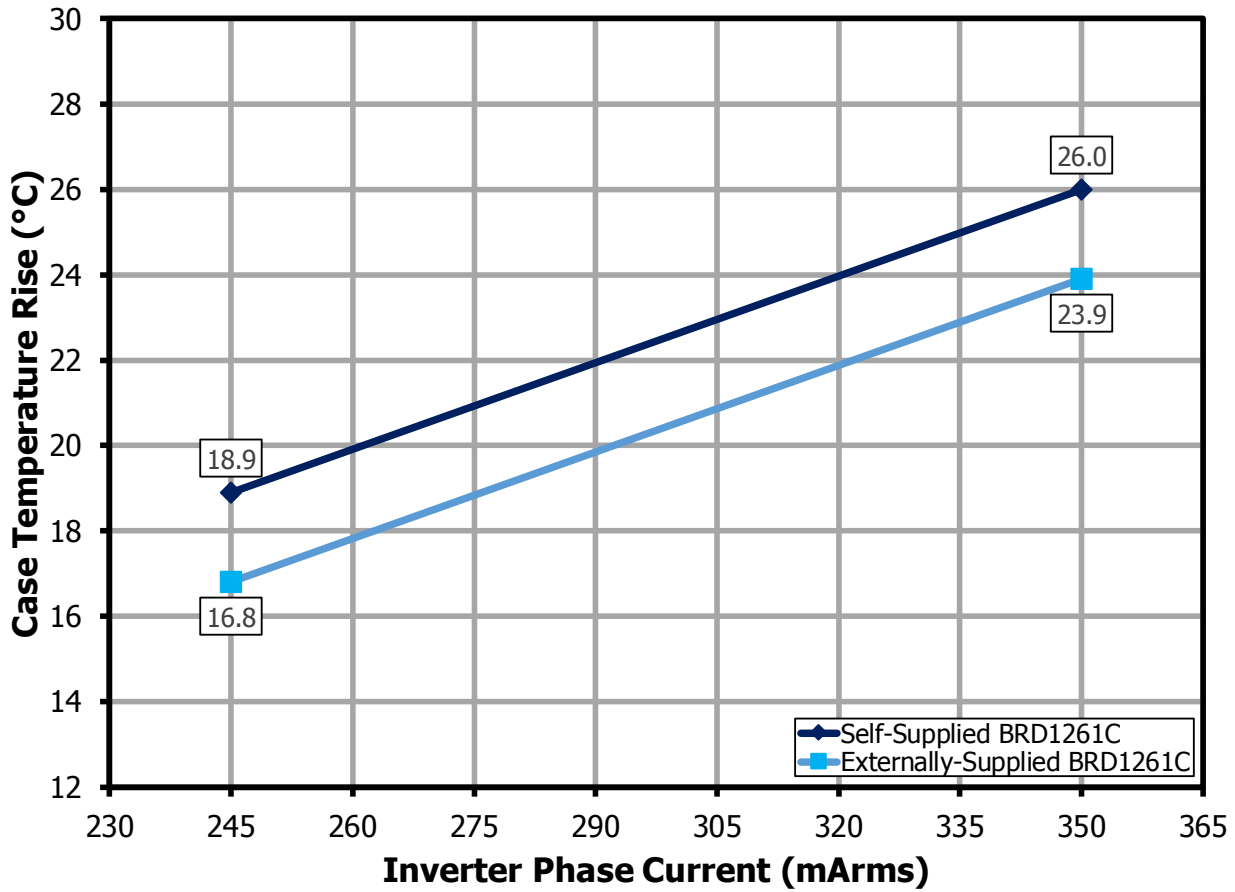

Figure 13 – Device Case Temperature Rise.

7.4 **Start-Up Operation**

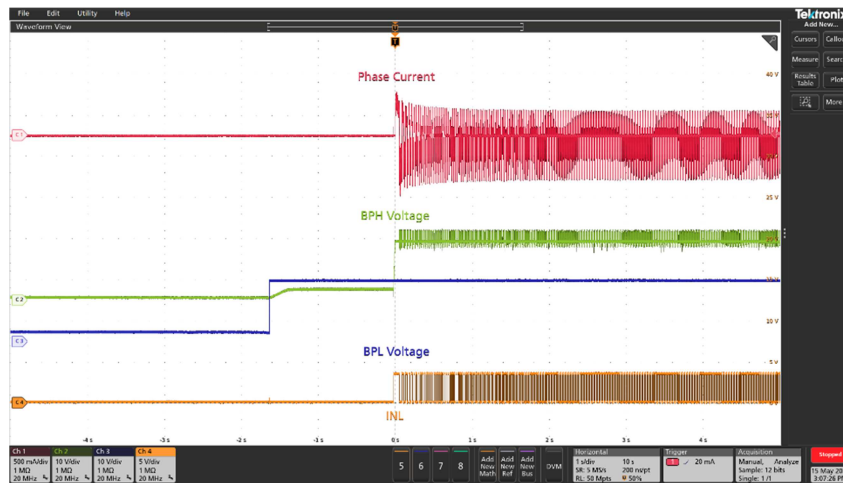

Figure 14 – BPH and BPL-pin Voltages at Start-Up.

- CH1: I_{PHASE} , 500 mA / div.
- CH2: V_{BPH} , 10 V / div.
- CH3: V_{BPL} , 10 V / div.
- CH4: V_{INL} , 5 V / div.
- Time: 1 s / div.

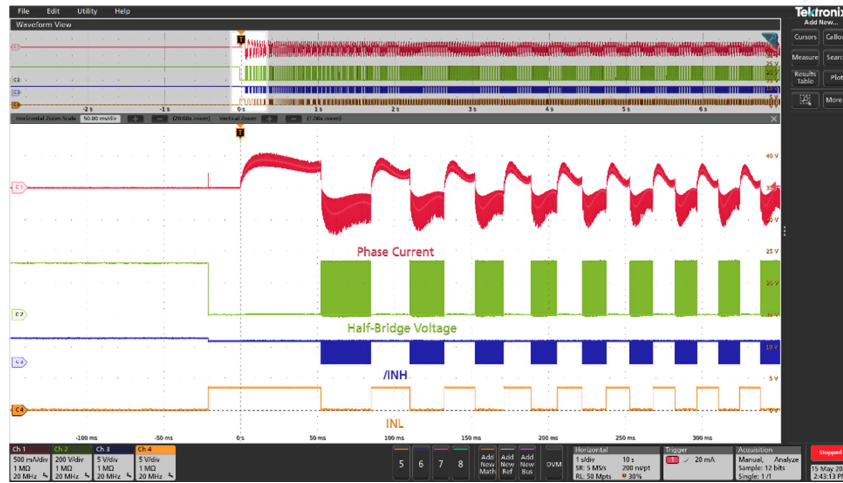

Figure 15 – Motor and PWM Waveforms during Start-Up.

- CH1: I_{PHASE} , 500 mA / div.
- CH2: V_{HB} , 200 V / div.
- CH3: $V_{/INH}$, 5 V / div.
- CH4: V_{INL} , 5 V / div.
- Time: 1 s / div.
- Zoom: 50 ms / div.

7.5 *Steady-State Operation*

7.5.1 Phase Current During Steady-State

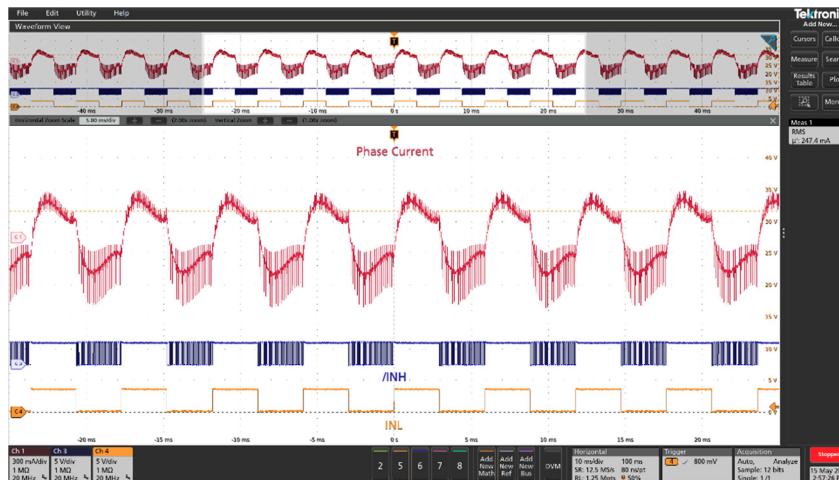

Figure 16 – Phase Current at 35 W Inverter Output Power.

CH1: I_{PHASE} , 300 mA / div. $I_{PHASE,RMS}$: 247.4 mA.

CH3: V_{INH} , 5 V / div.

CH4: V_{INL} , 5 V / div.

Time: 10 ms / div.

Zoom: 5 ms / div.

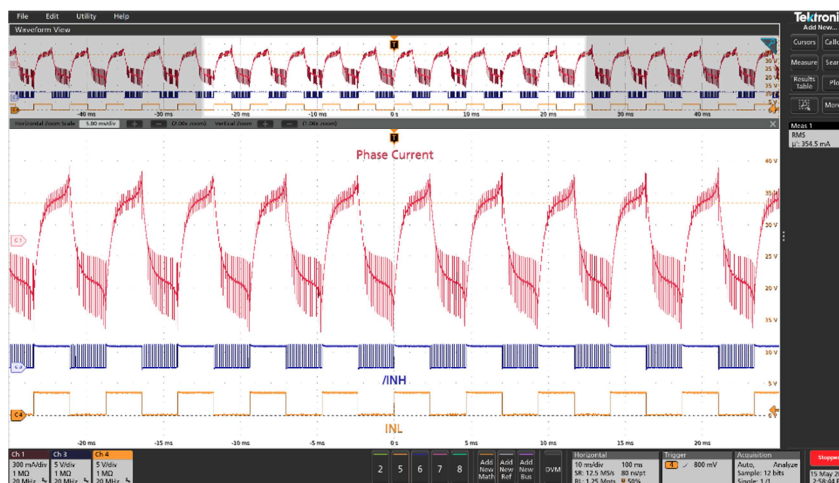

Figure 17 – Phase Current at 70 W Inverter Output Power.

CH1: I_{PHASE} , 300 mA / div. $I_{PHASE,RMS}$: 354.5 mA.

CH3: V_{INH} , 5 V / div.

CH4: V_{INL} , 5 V / div.

Time: 10 ms / div.

Zoom: 5 ms / div.

7.5.2 Half-Bridge Voltages During Steady-State

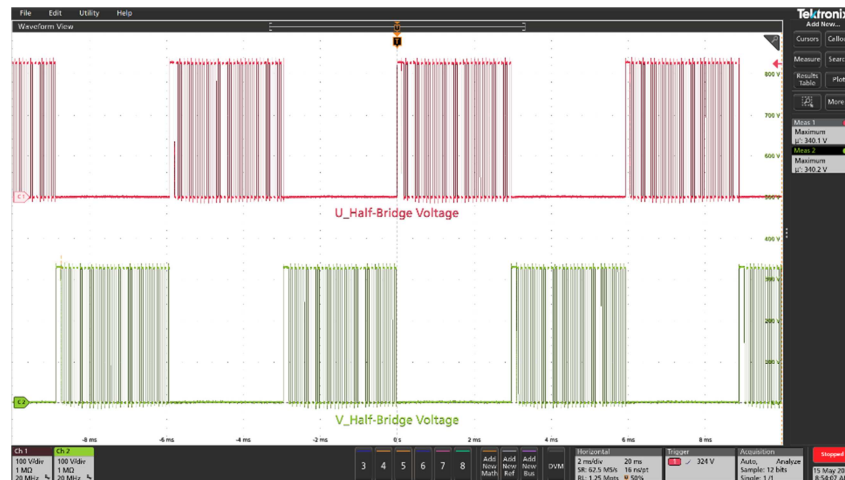

Figure 18 – Half-Bridge Voltages at 35 W Inverter Output Power.

CH1: $V_{HB(U)}$, 100 V / div. $V_{HB(U),MAX}$: 340.1 V.

CH2: $V_{HB(V)}$, 100 V / div. $V_{HB(V),MAX}$: 340.2 V.

Time: 2 ms / div.

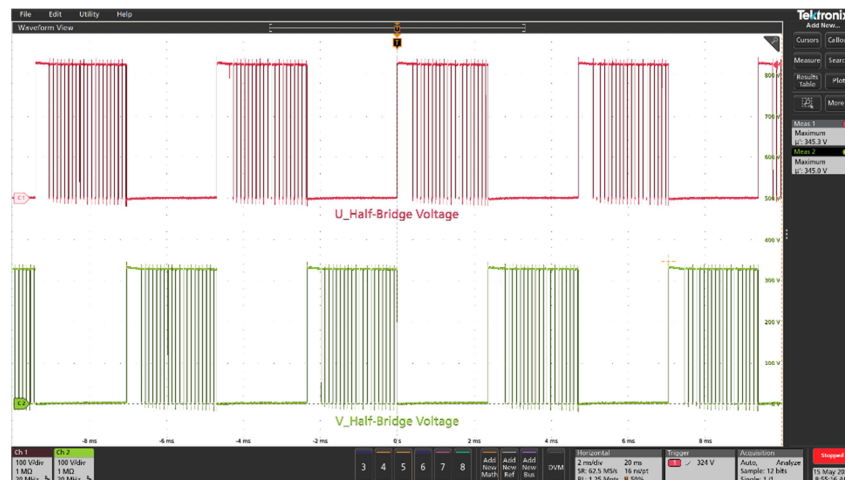

Figure 19 – Half-Bridge Voltages at 70 W Inverter Output Power.

CH1: $V_{HB(U)}$, 100 V / div. $V_{HB(U),MAX}$: 345.3 V.

CH2: $V_{HB(V)}$, 100 V / div. $V_{HB(V),MAX}$: 345.0 V.

Time: 2 ms / div.

7.5.3 /INH and INL Input Signals During Steady-State

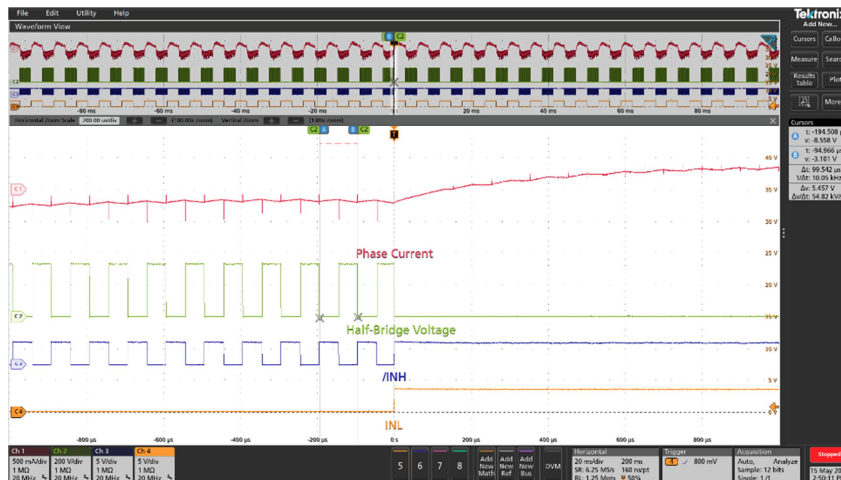

Figure 20 – /INH and INL Signals at 35 W Inverter Output Power.

CH1: I_{PHASE} , 500 mA / div.
 CH2: V_{HB} , 200 V / div.
 CH3: $V_{/INH}$, 5 V / div.
 CH4: V_{INL} , 5 V / div.
 Time: 20 ms / div.
 Zoom: 200 μs / div. f_{PWM} : 10.05 kHz.

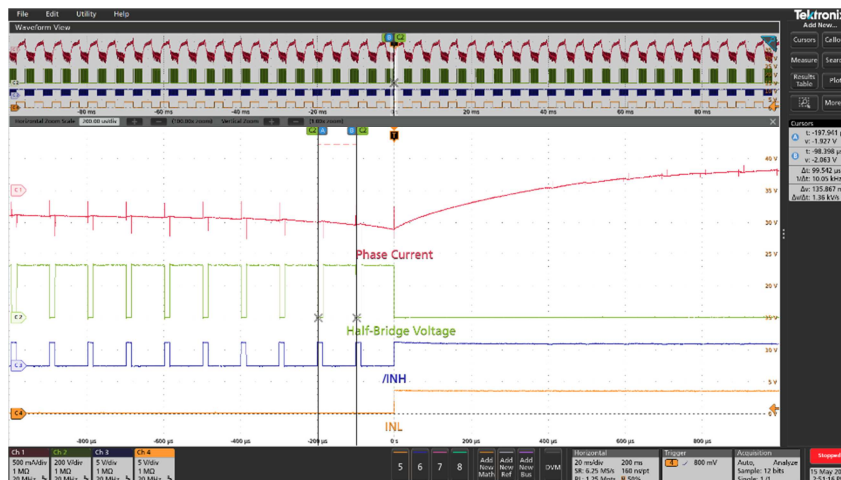

Figure 21 – /INH and INL Signals at 70 W Inverter Output Power.

CH1: I_{PHASE} , 500 mA / div.
 CH2: V_{HB} , 200 V / div.
 CH3: $V_{/INH}$, 5 V / div.
 CH4: V_{INL} , 5 V / div.
 Time: 20 ms / div.
 Zoom: 200 μs / div. f_{PWM} : 10.05 kHz.

7.5.4 Bypass Pin Voltages During Steady-State

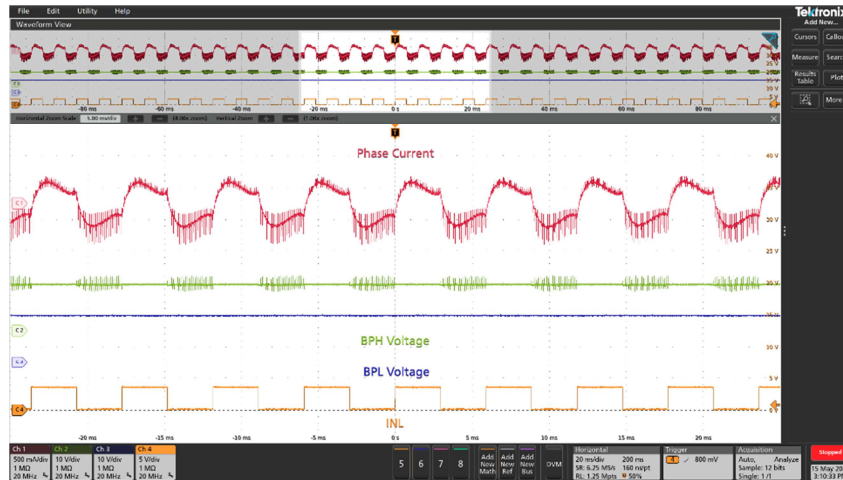

Figure 22 – BPH and BPL-pin Voltages at 35 W Inverter Output Power.

CH1: I_{PHASE} , 500 mA / div.
 CH2: V_{BPH} , 10 V / div.
 CH3: V_{BPL} , 10 V / div.
 CH4: V_{INL} , 5 V / div.
 Time: 20 ms / div.
 Zoom: 5 ms / div.

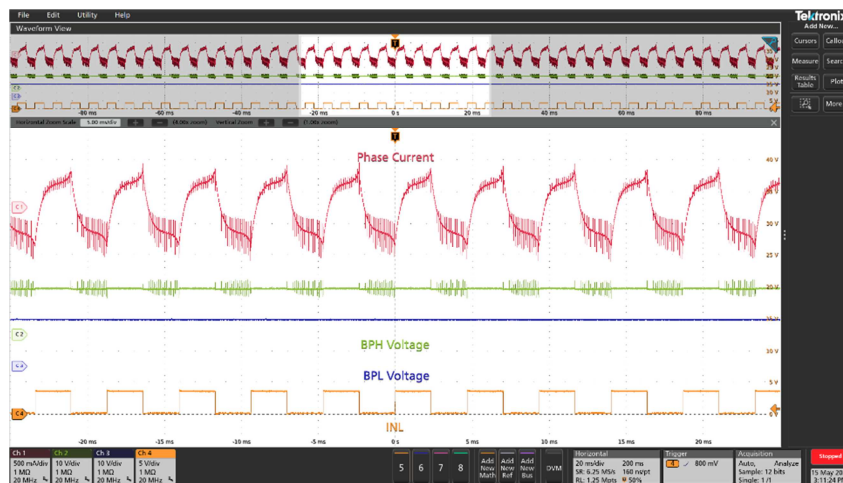

Figure 23 – BPH and BPL-pin Voltages at 70 W Inverter Output Power.

CH1: I_{PHASE} , 500 mA / div.
 CH2: V_{BPH} , 10 V / div.
 CH3: V_{BPL} , 10 V / div.
 CH4: V_{INL} , 5 V / div.
 Time: 20 ms / div.
 Zoom: 5 ms / div.



7.5.5 Phase Current Information Output (IPH)

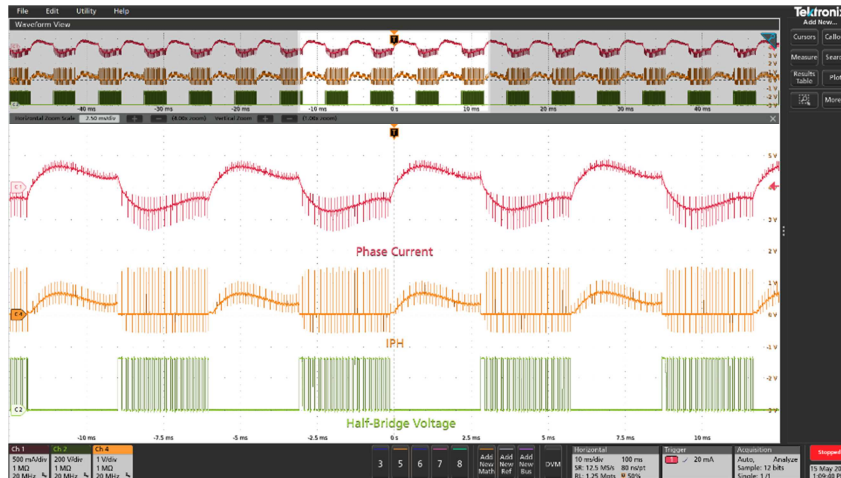

Figure 24 – IPH Output Signal at 35 W Inverter Output Power.

CH1: I_{PHASE} , 500 mA / div.
 CH2: V_{HB} , 200 V / div.
 CH4: V_{IPH} , 1 V / div.
 Time: 10 ms / div.
 Zoom: 2.5 ms / div.

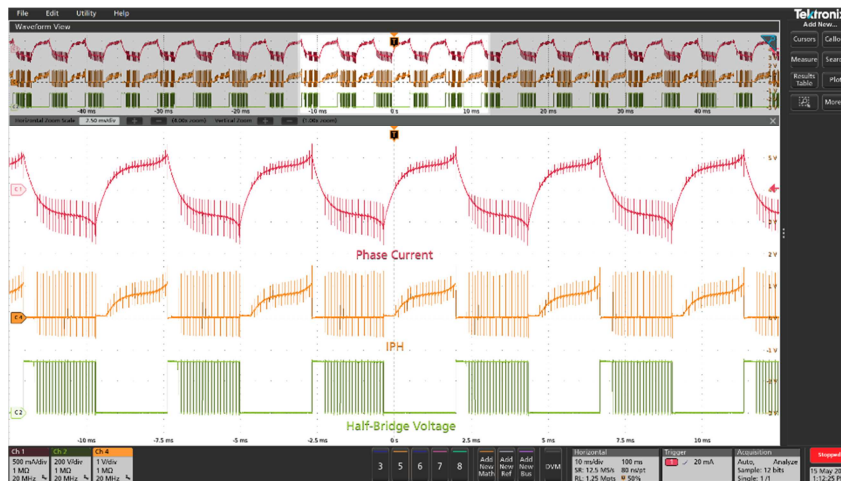

Figure 25 – IPH Output Signal at 70 W Inverter Output Power.

CH1: I_{PHASE} , 500 mA / div.
 CH2: V_{HB} , 200 V / div.
 CH4: V_{IPH} , 1 V / div.
 Time: 10 ms / div.
 Zoom: 2.5 ms / div.

7.5.6 FREDFET Drain Voltage Slew Rate at Full Load

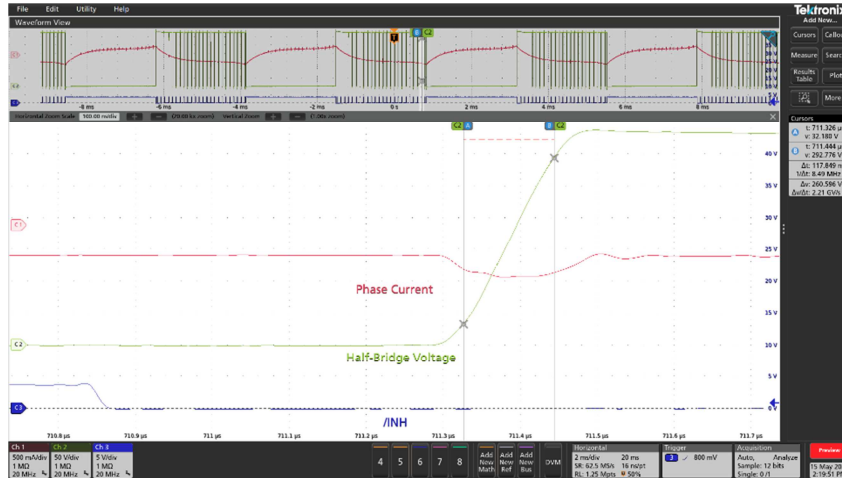

Figure 26 – Drain Voltage (Turn-Off) 70 W Inverter Output Power.
 CH1: I_{PHASE} , 500 mA / div.
 CH2: V_{HB} , 50 V / div.
 CH3: V_{INH} , 5 V / div.
 Time: 2 ms / div.
 Zoom: 100 ns / div. Turn-Off Slew Rate: 2.21 V / ns.



Figure 27 – Drain Voltage (Turn-On) 70 W Inverter Output Power.
 CH1: I_{PHASE} , 500 mA / div.
 CH2: V_{HB} , 50 V / div.
 CH3: V_{INH} , 5 V / div.
 Time: 2 ms / div.
 Zoom: 100 ns / div. Turn-On Slew Rate: 2.12 V / ns.

8 Device and System Level Protection and Monitoring

8.1 Integrated Cycle-by-Cycle Current Limit

Figures 28 and 29 illustrate the integrated cycle-by-cycle current limit of the BridgeSwitch devices. Resistor R14 and R16 were replaced by 133 k Ω (yielding a typical current limit of 0.630 A) to demonstrate the current limit.

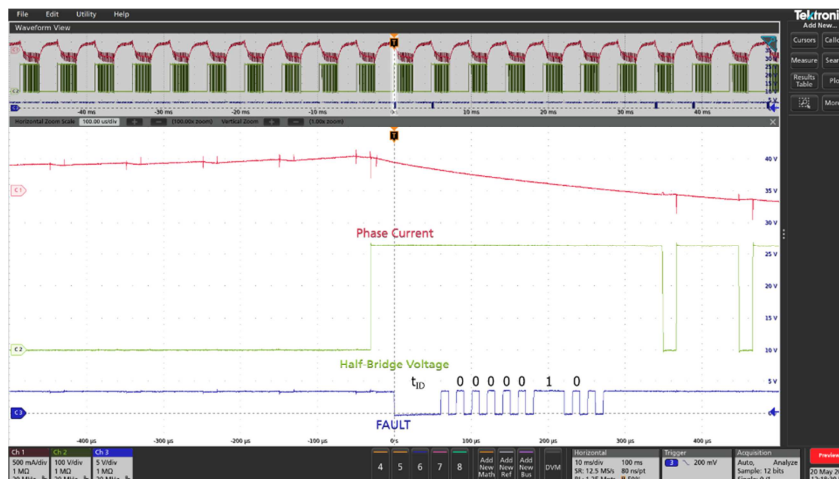

Figure 28 – CH1: I_{PHASE} , 500 mA / div. I_{pk} : 625 mA.
 CH2: V_{HB} , 100 V / div.
 CH3: V_{FAULT} , 5 V / div.
 Time: 10 ms / div.
 Zoom: 100 μ s / div. Low-Side FET Overcurrent U1.

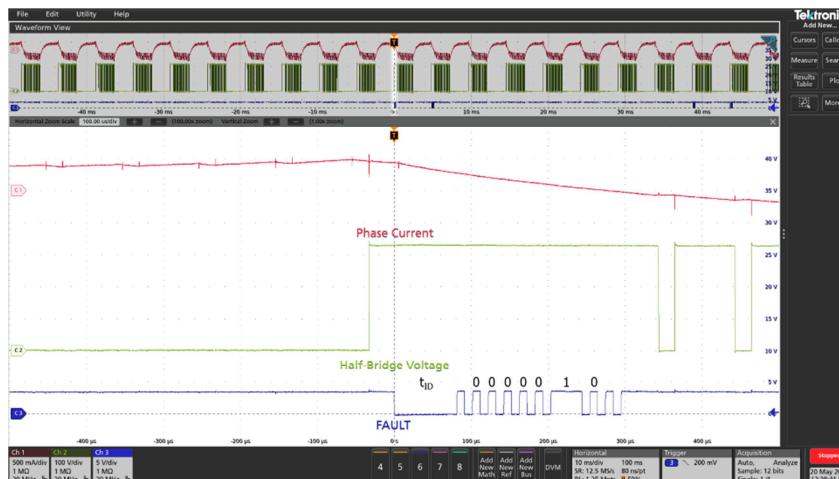

Figure 29 – CH1: I_{PHASE} , 500 mA / div. I_{pk} : 592 mA.
 CH2: V_{HB} , 100 V / div.
 CH3: V_{FAULT} , 5 V / div.
 Time: 10 ms / div.
 Zoom: 100 μ s / div. Low-Side FET Overcurrent U2.

8.2 Two-level Device Over-Temperature Protection

Figures 30 and 31 illustrate two-level device over-temperature warning and protection of the BridgeSwitch devices. An external heat source is applied to device U1 during operation.

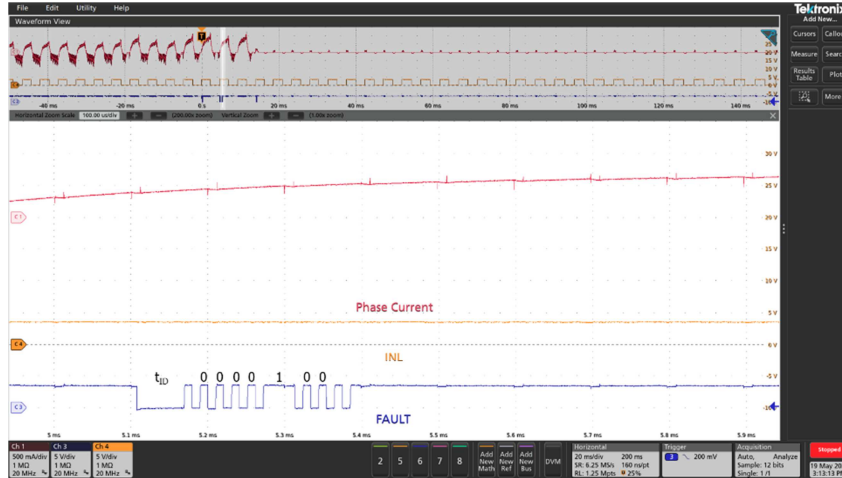

Figure 30 – CH1: I_{PHASE} , 500 mA / div.
 CH3: $V_{/INL}$, 5 V / div.
 CH4: $V_{/INL}$, 5 V / div.
 Time: 20 ms / div.
 Zoom: 100 μ s / div. Over-Temperature Warning U1.

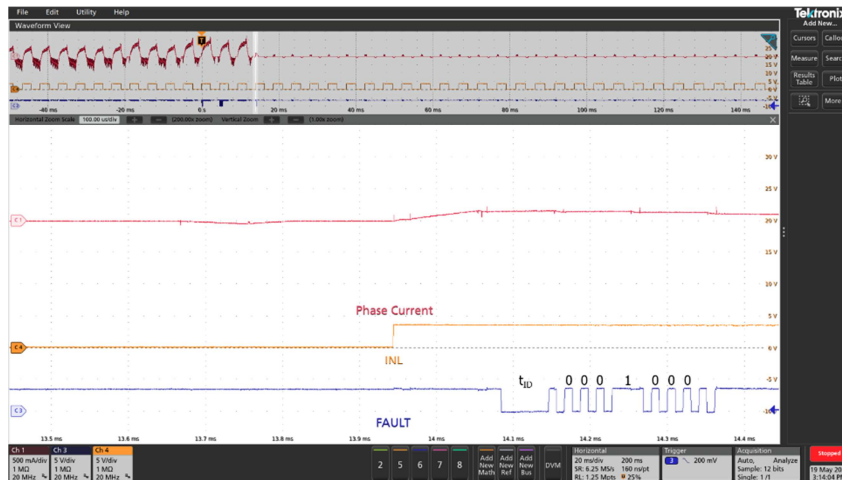

Figure 31 – CH1: I_{PHASE} , 500 mA / div.
 CH3: $V_{/INL}$, 5 V / div.
 CH4: $V_{/INL}$, 5 V / div.
 Time: 20 ms / div.
 Zoom: 100 μ s / div. Over-Temperature Protection U1.

8.3 High-Voltage DC Bus Monitoring

8.3.1 Undervoltage Thresholds

Figures 32 to 35 illustrate the four levels of undervoltage thresholds. BridgeSwitch device U2 senses the reduction in input voltage and provides the status report.

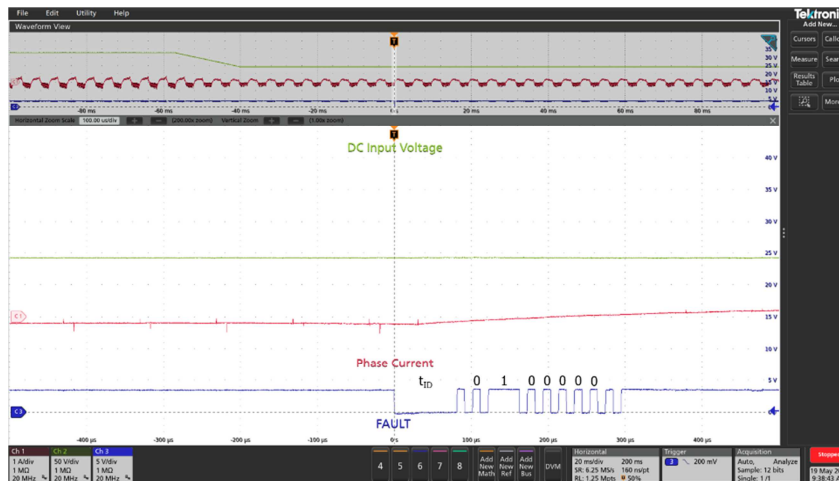

Figure 32 – 325 to 240 V_{DC} , Slew Rate: 5 V / ms.

CH1: I_{PHASE} , 1 A / div.

CH2: $V_{DC\ INPUT}$, 50 V / div.

CH3: V_{FAULT} , 5 V / div.

Time: 20 ms / div.

Zoom: 100 μ s / div. Undervoltage I_{UV100} U2.

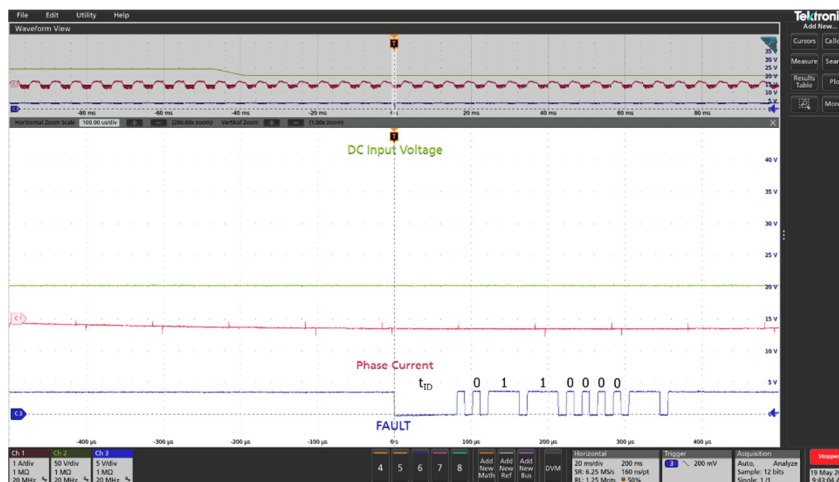

Figure 33 – 240 to 200 V_{DC} , Slew Rate: 5 V / ms.

CH1: I_{PHASE} , 1 A / div.

CH2: $V_{DC\ INPUT}$, 50 V / div.

CH3: V_{FAULT} , 5 V / div.

Time: 20 ms / div.

Zoom: 100 μ s / div. Undervoltage I_{UV85} U2.

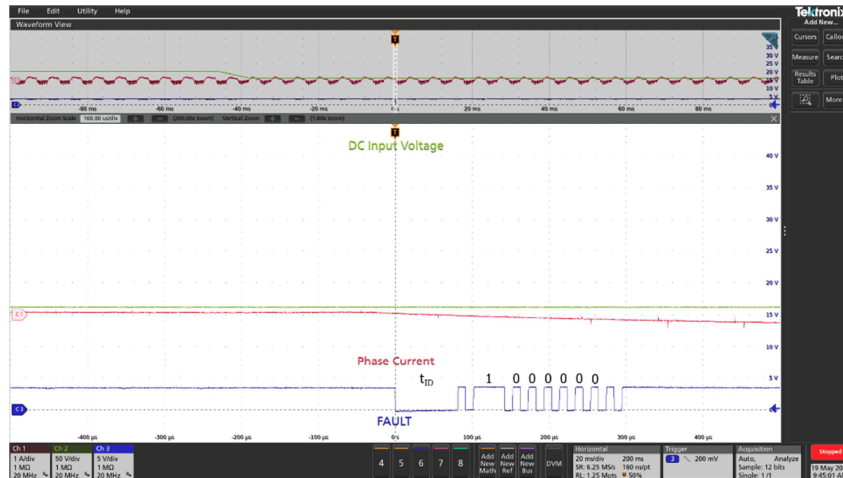

Figure 34 – 200 to 160 V_{DC} , Slew Rate: 5 V / ms.

CH1: I_{PHASE} , 1 A / div.

CH2: $V_{DC INPUT}$, 50 V / div.

CH3: V_{FAULT} , 5 V / div.

Time: 20 ms / div.

Zoom: 100 μ s / div. Undervoltage I_{UV70} U2.

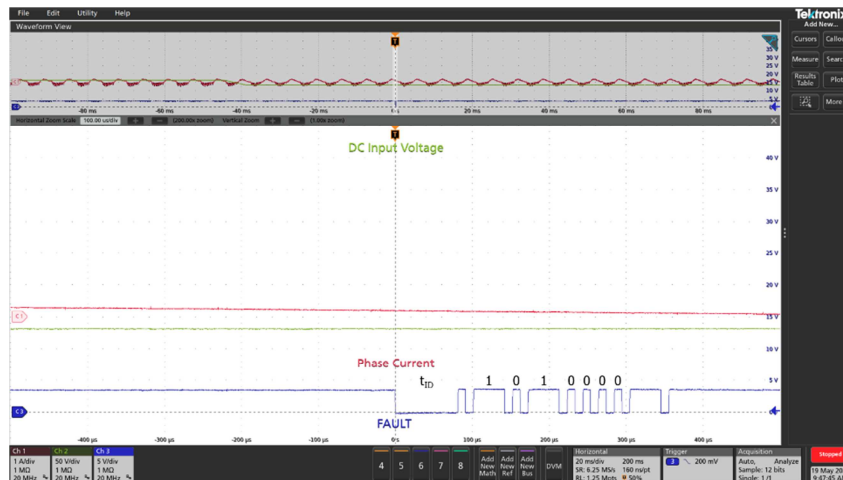

Figure 35 – 160 to 130 V_{DC} , Slew Rate: 5 V / ms.

CH1: I_{PHASE} , 1 A / div.

CH2: $V_{DC INPUT}$, 50 V / div.

CH3: V_{FAULT} , 5 V / div.

Time: 20 ms / div.

Zoom: 100 μ s / div. Undervoltage I_{UV55} U2.

8.3.2 Overvoltage Threshold

Figures 36 and 37 illustrate the overvoltage threshold and hysteresis. BridgeSwitch device U2 senses the increase in input voltage and provides the status report.

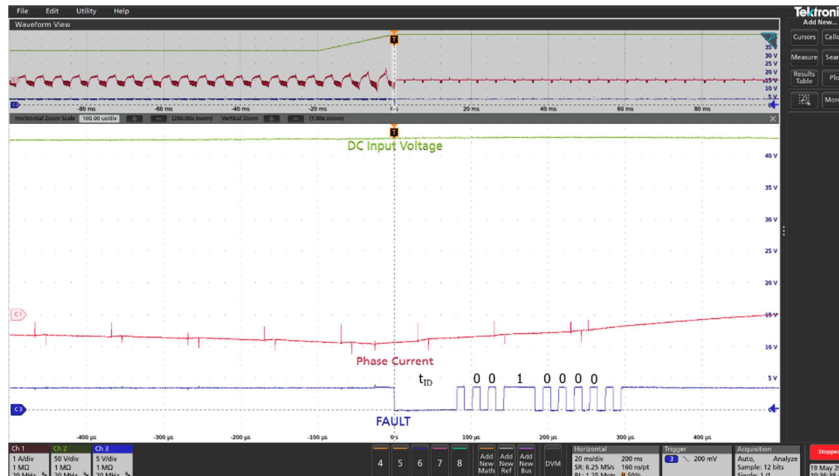

Figure 36 – 325 to 425 V_{DC} , Slew Rate: 5 V / ms.

CH1: I_{PHASE} , 1 A / div.

CH2: $V_{DC\ INPUT}$, 50 V / div.

CH3: V_{FAULT} , 5 V / div.

Time: 20 ms / div.

Zoom: 100 μ s / div. Overvoltage I_{OV} U2.

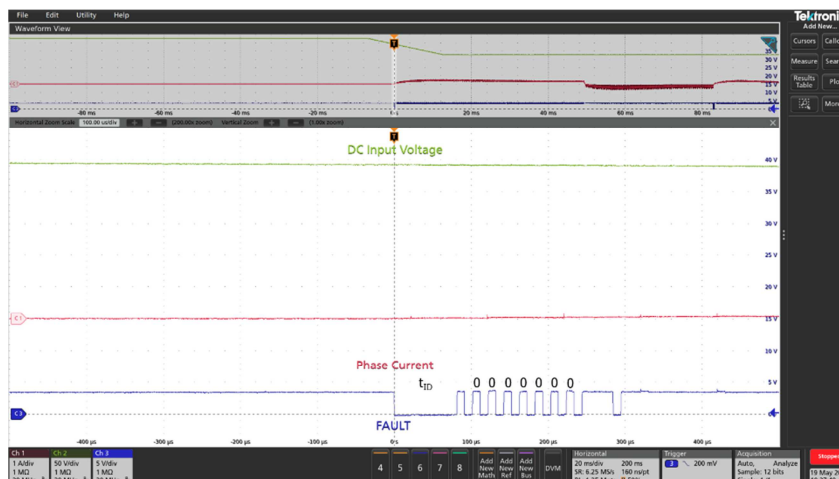

Figure 37 – 425 to 325 V_{DC} , Slew Rate: 5 V / ms.

CH1: I_{PHASE} , 1 A / div.

CH2: $V_{DC\ INPUT}$, 50 V / div.

CH3: V_{FAULT} , 5 V / div.

Time: 20 ms / div.

Zoom: 100 μ s / div. Device Ready (no faults) U2.

9 Abnormal Motor Operation

This section provides the results of the abnormal operation tests performed on the RD-872 inverter board. The abnormal operation test complies with the abnormal test for appliances with motors as described in IEC 60335-1 standard (safety of household and similar electrical appliances). The abnormal operation tests cover the following:

1. Motor stall conditions
2. Motor operation during overload
3. Motor winding disconnect during operation

The test results demonstrate the integrated protection mechanism feature of BridgeSwitch under such abnormal operations without microcontroller intervention for protection.

9.1 Motor Stall Conditions

Figures 38 and 39 illustrate the motor stall during start-up and running operation. Motor is non-operational during testing with no damage to device or motor during or after testing.

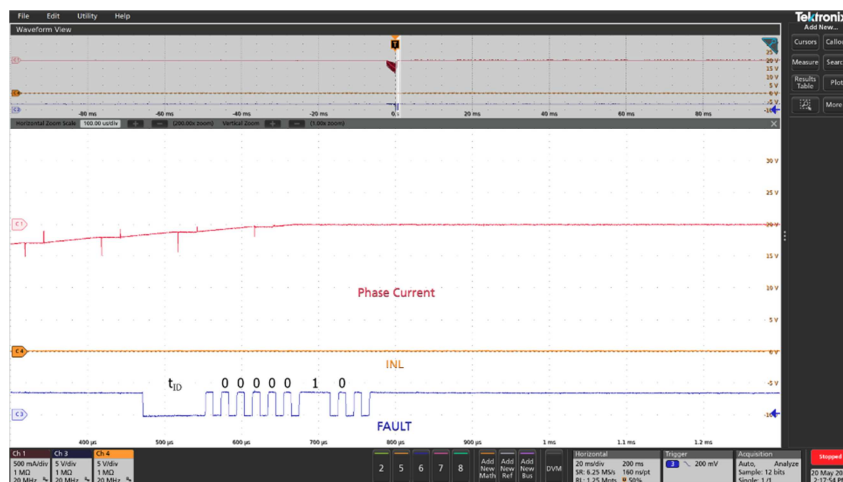

Figure 38 – Motor Stalled During Start-Up Condition.

CH1: I_{PHASE} , 500 mA / div.

CH3: V_{INH} , 5 V / div.

CH4: V_{INL} , 5 V / div.

Time: 20 ms / div.

Zoom: 100 μ s / div. Low-Side FET Overcurrent U2.

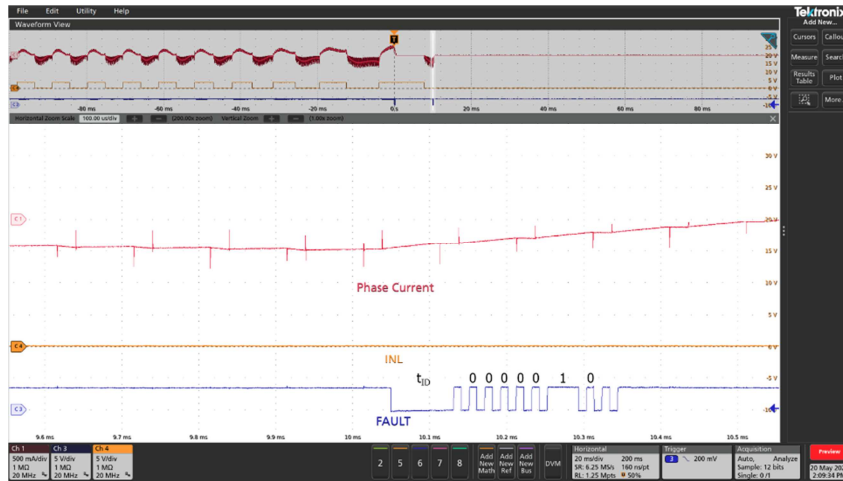

Figure 39 – Motor Stalled During Running Condition.

CH1: I_{PHASE} , 500 mA / div.

CH3: V_{INHL} , 5 V / div.

CH4: V_{INLr} , 5 V / div.

Time: 20 ms / div.

Zoom: 100 μs / div. Low-Side FET Overcurrent U2.

9.2 Motor Overload During Operation

Figures 40 illustrates the motor overload during operation. Motor will stall upon overload during testing with no damage to device or motor during or after testing.

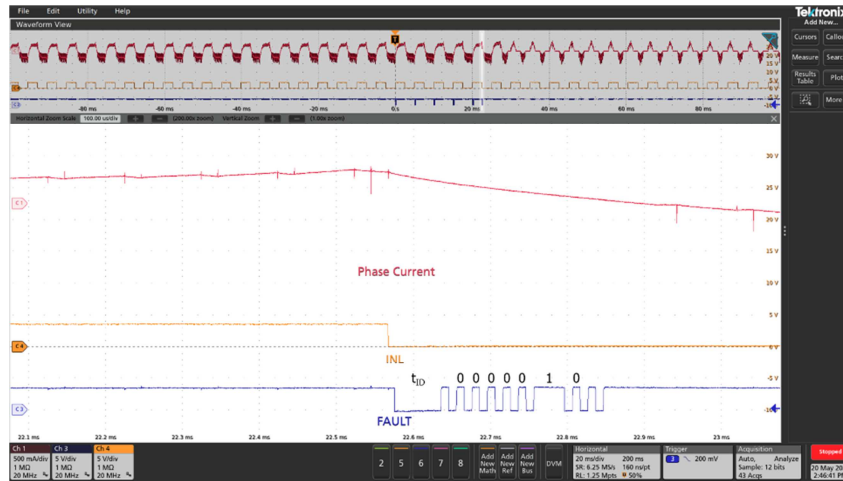

Figure 40 – CH1: I_{PHASE} , 500 mA / div.
 CH3: V_{INH} , 5 V / div.
 CH4: V_{INL} , 5 V / div.
 Time: 20 ms / div.
 Zoom: 100 μ s / div. Low-Side FET Overcurrent U1.

9.3 **Motor Winding Disconnect During Operation**

Figure 41 illustrates the motor winding disconnect during operation. Winding disconnection results to a signal distortion in the FAULT bus. Overcurrent faults occur after the high-side driver not ready fault and the motor will stall during testing with no damage to device or motor during or after testing.

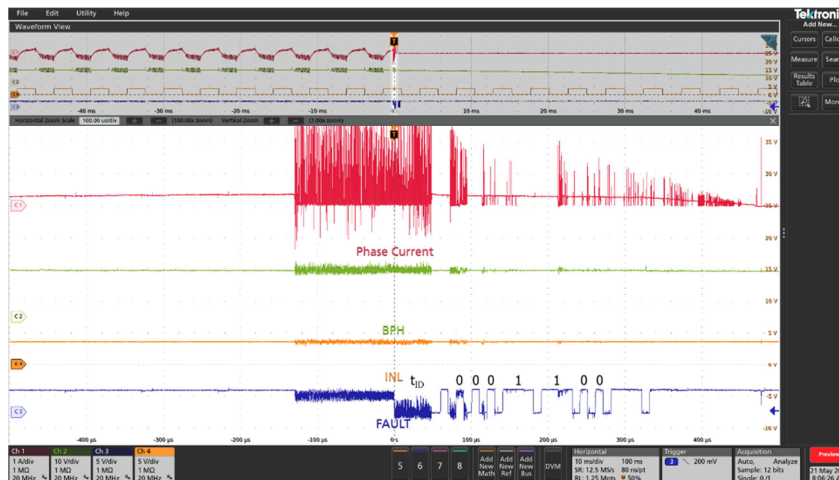

Figure 41 – CH1: I_{PHASE} , 1 A / div.
 CH2: V_{BPH} , 10 V / div.
 CH3: V_{FAULT} , 5 V / div.
 CH4: V_{INL} , 5 V / div.
 Time: 10 ms / div.
 Zoom: 100 μ s / div. High-Side Driver Not Ready U1.

10 Appendix

10.1 *Inverter Circuit Board Manual*

Figure 42 illustrates the locations and functions of all connectors for the single-phase inverter board.

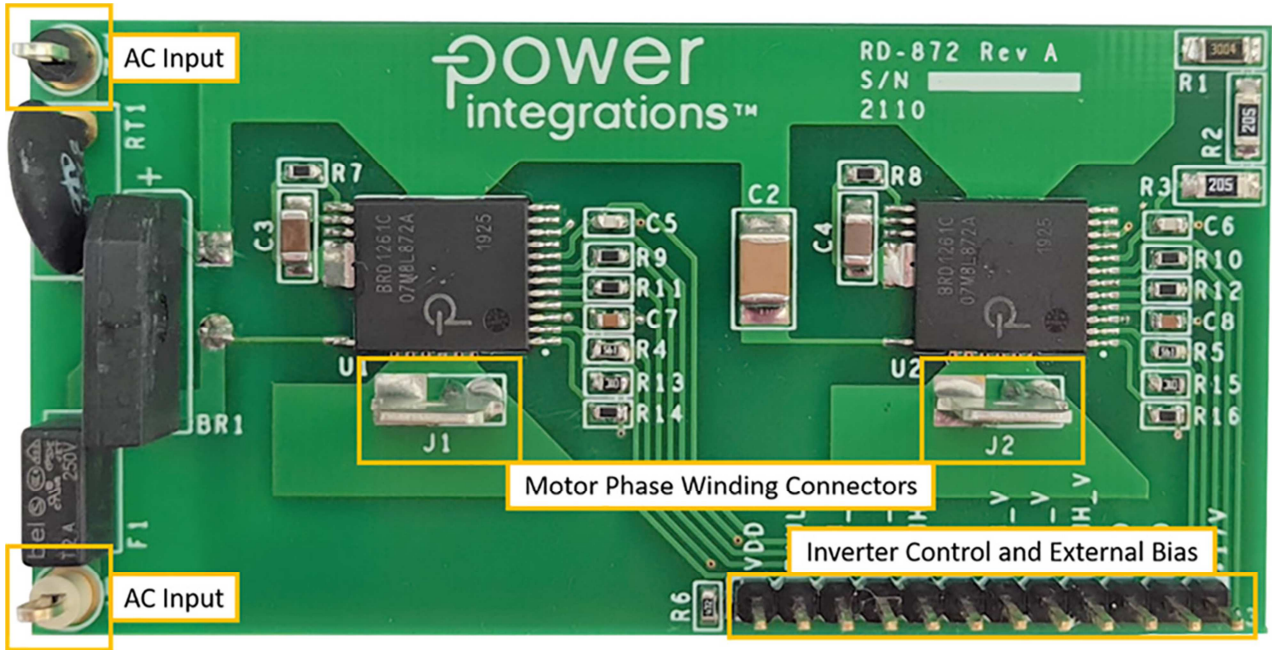

Figure 42 – Single-Phase Inverter Board Connectors.

The AC input required to operate the inverter board is connected through test points, TP1 and TP2.

The single motor winding is connected through quick-connect solder tabs, J1 and J2. The half-bridge output of device U1 is connected to J1 while the half-bridge output of device U2 is connected to J2.

The inverter control and external bias are connected through the male header connector, J3. Figure 43 illustrates the physical specifications of the male header connector J3. The functions tied to this connector include the pull-up supply for the communication bus, control input signals, optional system monitor input, phase current information output signals and the external supply for low-side capacitor bias. Table 4 illustrates the pin assignments and detailed information for the male header connector J3.

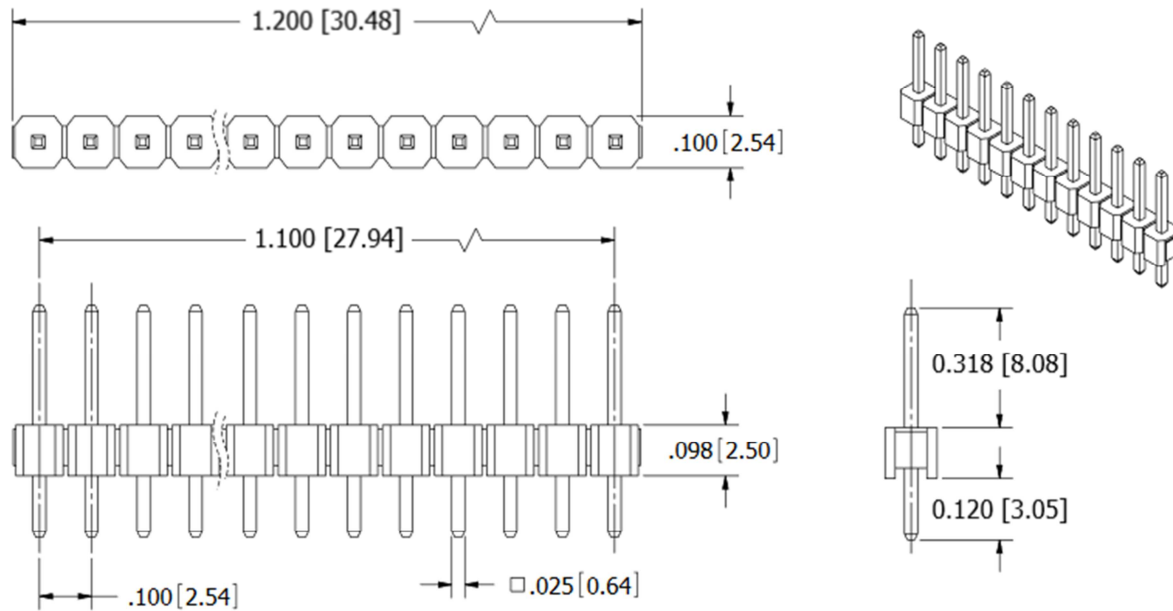

Figure 43 – Inverter Control and External Bias Connector Specifications.

Pin No	Signal	Type	Details
1	VDD	Input	Pull-up supply for communication for status update communication bus, 3.3 V and 5 V compatible
2	FAULT	Input/Output	Single-wire, bidirectional communication bus (open-Drain)
3	IPH_U	Output	Instantaneous phase current information output of device U1
4	INL_U	Input	Gate-drive signal for low-side FREDFET of device U1, active high, 3.3 V and 5 V compatible
5	/INH_U	Input	Gate-drive signal for high-side FREDFET of device U1, active low, 3.3 V and 5 V compatible
6	SM	Input	System monitor input (e.g. high-voltage DC bus monitoring, system level temperature monitoring)
7	IPH_V	Output	Instantaneous phase current information output of device U2
8	INL_V	Input	Gate-drive signal for low-side FREDFET of device U2, active high, 3.3 V and 5 V compatible
9	/INH_V	Input	Gate-drive signal for high-side FREDFET of device U2, active low, 3.3 V and 5 V compatible
10	GND	n/a	Ground reference for connector input and output signals, inverter and system MCU
11	GND	n/a	Ground reference for connector input and output signals, inverter and system MCU
12	+17V	Input	External supply for low-side bypass capacitor bias

Table 4 – Inverter Board Interface Connector Pin Assignments.

10.2 **Status Word Encoding**

BridgeSwitch uses a 7-bit word followed by a parity bit to report a status update. Table 5 summarizes how various conditions are encoded. The 7-bit word consists of five blocks with status changes grouped together that cannot occur at the same time. This enables simultaneous reporting of multiple fault conditions to the system MCU.

The status register entry in the bottom row (7-bit word "000 00 0 0") encodes Device Ready status and is used to communicate a successful power-up sequence. The device also sends it to acknowledge a status request sent by the system MCU in case no fault condition is present at the time. The parity bit is generated using odd parity.

FAULT	Bit 0	Bit 1	Bit 2	Bit 3	Bit 4	Bit 5	Bit 6
HV bus OV	0	0	1				
HV bus UV 100%	0	1	0				
HV bus UV 85%	0	1	1				
HV bus UV 70%	1	0	0				
HV bus UV 55%	1	0	1				
System thermal fault	1	1	0				
LS Driver not ready ^[1]	1	1	1				
LS FET thermal warning				0	1		
LS FET thermal shutdown				1	0		
HS Driver not ready ^[2]				1	1		
LS FET over-current						1	
HS FET over-current							
Device Ready (no faults)	0	0	0	0	0	0	0

Notes:

1. Includes XL-pin open/short circuit fault, IPH pin to XL pin short circuit, and trim bit corruption
2. Includes HS-to-LS communication loss, V_{BPH} or internal 5 V rail out of range, and XH pin open/short-circuit fault

Table 5 – Status Word Encoding.

10.3 Test Bench Set-up

Figure 44 illustrates the test bench used to obtain the performance data of the single-phase inverter in this report. Table 6 details the specific equipment used in this report.

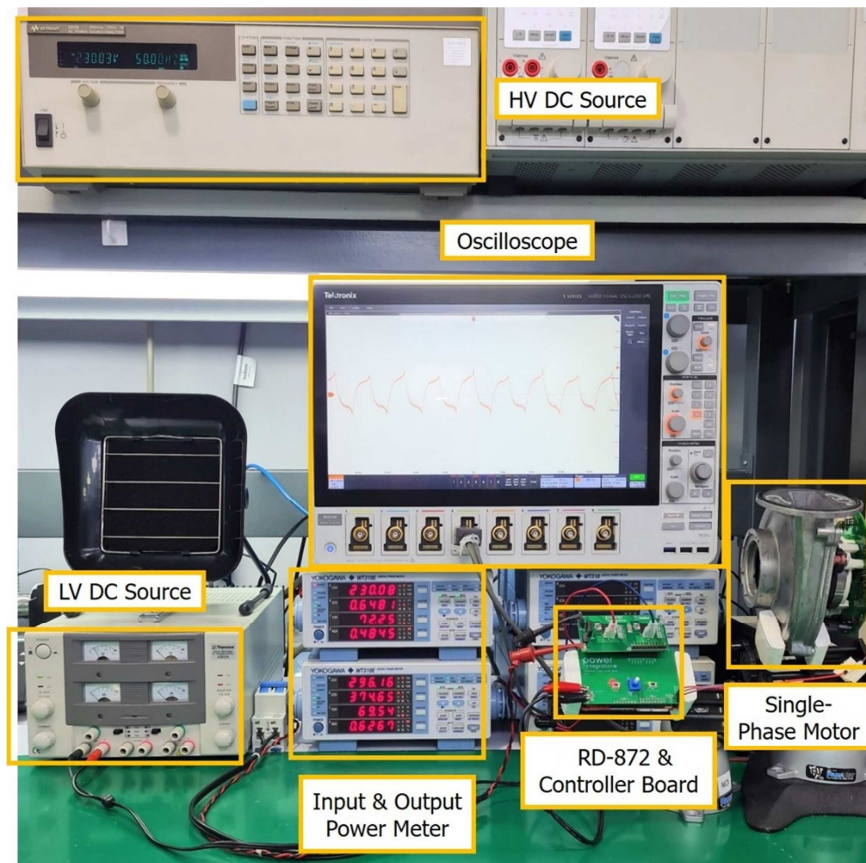

Figure 44 – Populated Circuit Board Photograph.

Test Bench Item	Model/Specification
HV DC Source	Keysight 6812B
Oscilloscope	Tektronix MSO58
LV DC Source	Topward 6303A
Input & Output Power Meter	Yokogawa W310E
Single-Phase Motor	NRG118/0800-3612 EC Centrifugal Fan
RD-872	Single-Phase Inverter
Controller Board	CY8CKIT-042 Pioneer Kit

Table 6 – Test Bench Details.

10.4 *Inverter Output Power Measurement*

Figure 45 illustrates the wattmeter configuration used to obtain the inverter input and output power in this report.

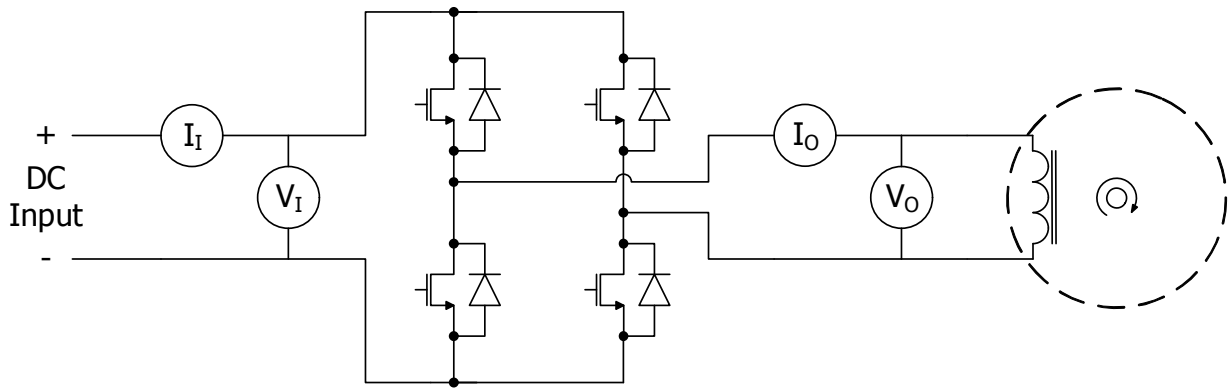

Figure 45 – Inverter Input and Output Power Measurement Diagram.

10.5 *Current Capability and Ambient Temperature*

Figure 46 illustrates the RMS current capability of the RD-872 single-phase inverter board. It shows two curves with two BRD1261C devices operating in self-supplied or externally-supplied operation at the respective BPL pins. Each curve details the available continuous RMS current at different board ambient temperatures with a package temperature of 100 °C.

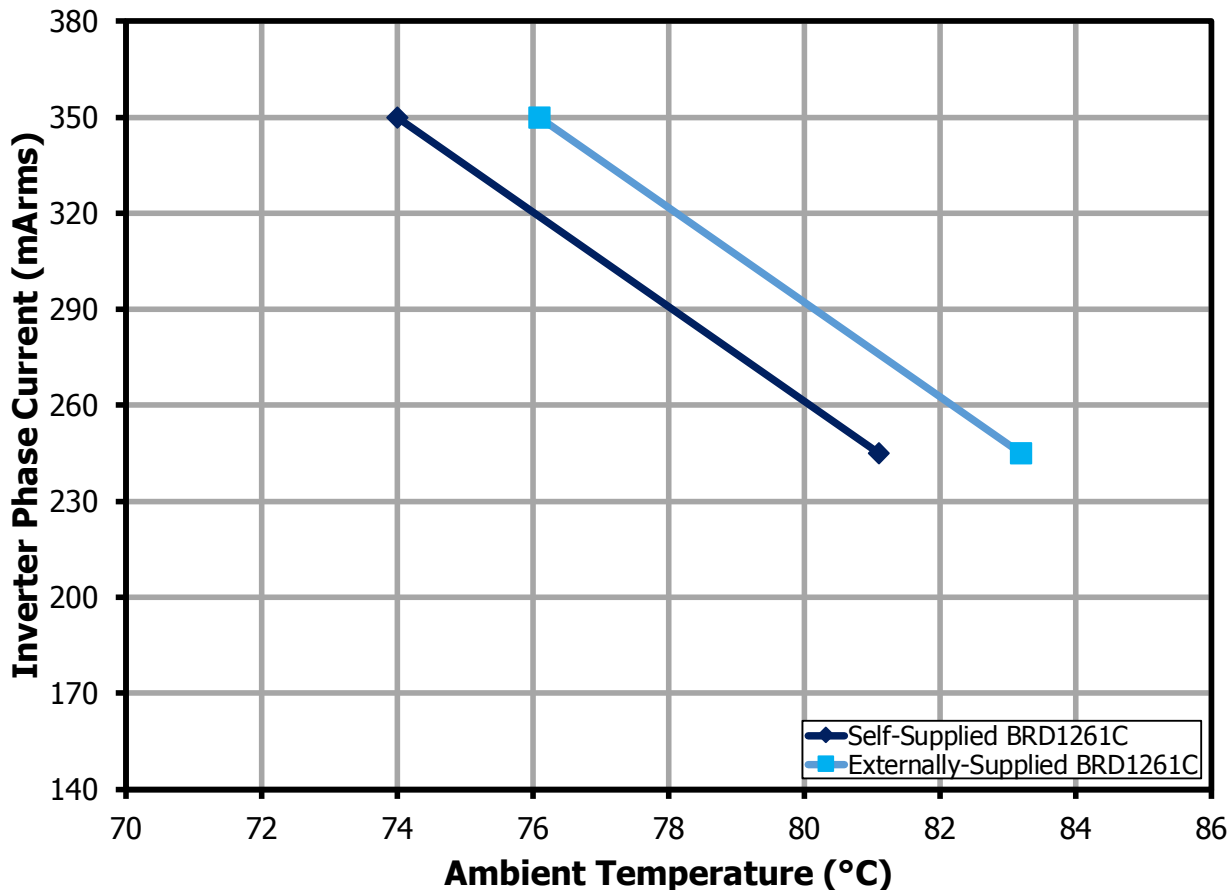

Figure 46 – Device Case Temperature Rise.

11 Revision History

Date	Author	Revision	Description & Changes	Reviewed
23-Mar-21	NAM	1.1	Initial Release	Apps & Mktg

