

UP Automation Edge Computing

Industrial Automation IoT Edge Computing

User's Manual 2nd Ed

Copyright Notice

This document is copyrighted, 2018. All rights are reserved. The original manufacturer reserves the right to make improvements to the products described in this manual at any time without notice.

No part of this manual may be reproduced, copied, translated, or transmitted in any form or by any means without the prior written permission of the original manufacturer. Information provided in this manual is intended to be accurate and reliable. However, the original manufacturer assumes no responsibility for its use, or for any infringements upon the rights of third parties that may result from its use.

The material in this document is for product information only and is subject to change without notice. While reasonable efforts have been made in the preparation of this document to assure its accuracy, AAEMON assumes no liabilities resulting from errors or omissions in this document, or from the use of the information contained herein.

AAEMON reserves the right to make changes in the product design without notice to its users.

Acknowledgement

All other products' name or trademarks are properties of their respective owners.

- Microsoft Windows is a registered trademark of Microsoft Corp.
- Intel, Pentium, Celeron, and Xeon are registered trademarks of Intel Corporation
- Core, Atom are trademarks of Intel Corporation
- ITE is a trademark of Integrated Technology Express, Inc.
- IBM, PC/AT, PS/2, and VGA are trademarks of International Business Machines Corporation.

All other product names or trademarks are properties of their respective owners.

Packing List

Before setting up your product, please make sure the following items have been shipped:

Item	Quantity
● AIoT-IGWS01	1

If any of these items are missing or damaged, please contact your distributor or sales representative immediately.

About this Document

This User's Manual contains all the essential information, such as detailed descriptions and explanations on the product's hardware and software features (if any), its specifications, dimensions, jumper/connector settings/definitions, and driver installation instructions (if any), to facilitate users in setting up their product.

Users may refer to the AAEON.com for the latest version of this document.

Safety Precautions

Please read the following safety instructions carefully. It is advised that you keep this manual for future references

1. All cautions and warnings on the device should be noted.
2. Make sure the power source matches the power rating of the device.
3. Position the power cord so that people cannot step on it. Do not place anything over the power cord.
4. Always completely disconnect the power before working on the system's hardware.
5. No connections should be made when the system is powered as a sudden rush of power may damage sensitive electronic components.
6. If the device is not to be used for a long time, disconnect it from the power supply to avoid damage by transient over-voltage.
7. Always disconnect this device from any AC supply before cleaning.
8. While cleaning, use a damp cloth instead of liquid or spray detergents.
9. Make sure the device is installed near a power outlet and is easily accessible.
10. Keep this device away from humidity.
11. Place the device on a solid surface during installation to prevent falls
12. Do not cover the openings on the device to ensure optimal heat dissipation.
13. Watch out for high temperatures when the system is running.
14. Do not touch the heat sink or heat spreader when the system is running
15. Never pour any liquid into the openings. This could cause fire or electric shock.
16. As most electronic components are sensitive to static electrical charge, be sure to ground yourself to prevent static charge when installing the internal components. Use a grounding wrist strap and contain all electronic components in any static-shielded containers.

17. If any of the following situations arises, please the contact our service personnel:
 - i. Damaged power cord or plug
 - ii. Liquid intrusion to the device
 - iii. Exposure to moisture
 - iv. Device is not working as expected or in a manner as described in this manual
 - v. The device is dropped or damaged
 - vi. Any obvious signs of damage displayed on the device
18. **DO NOT LEAVE THIS DEVICE IN AN UNCONTROLLED ENVIRONMENT WITH TEMPERATURES BEYOND THE DEVICE'S PERMITTED STORAGE TEMPERATURES (SEE CHAPTER 1) TO PREVENT DAMAGE.**

Warning!



This device complies with Part 15 FCC Rules. Operation is subject to the following two conditions: (1) this device may not cause harmful interference, and (2) this device must accept any interference received including interference that may cause undesired operation.

Caution:

There is a danger of explosion if the battery is incorrectly replaced. Replace only with the same or equivalent type recommended by the manufacturer. Dispose of used batteries according to the manufacturer's instructions and your local government's recycling or disposal directives.

Attention:

Il y a un risque d'explosion si la batterie est remplacée de façon incorrecte. Ne la remplacer qu'avec le même modèle ou équivalent recommandé par le constructeur. Recycler les batteries usées en accord avec les instructions du fabricant et les directives gouvernementales de recyclage.

China RoHS Requirements (CN)

产品中有毒有害物质或元素名称及含量

AAEON Main Board/ Daughter Board/ Backplane

部件名称	有毒有害物质或元素					
	铅 (Pb)	汞 (Hg)	镉 (Cd)	六价铬 (Cr(VI))	多溴联苯 (PBB)	多溴二苯醚 (PBDE)
印刷电路板 及其电子组件	○	○	○	○	○	○
外部信号 连接器及线材	○	○	○	○	○	○
<p>O: 表示该有毒有害物质在该部件所有均质材料中的含量均在 SJ/T 11363-2006 标准规定的限量要求以下。</p> <p>X: 表示该有毒有害物质至少在该部件的某一均质材料中的含量超出 SJ/T 11363-2006 标准规定的限量要求。</p> <p>备注: 此产品所标示之环保使用期限, 系指在一般正常使用状况下。</p>						

China RoHS Requirement (EN)

Poisonous or Hazardous Substances or Elements in Products

AAEON Main Board/ Daughter Board/ Backplane

Component	Poisonous or Hazardous Substances or Elements					
	Lead (Pb)	Mercury (Hg)	Cadmium (Cd)	Hexavalent Chromium (Cr(VI))	Polybrominated Biphenyls (PBB)	Polybrominated Diphenyl Ethers (PBDE)
PCB & Other Components	○	○	○	○	○	○
Wires & Connectors for External Connections	○	○	○	○	○	○
<p>O: The quantity of poisonous or hazardous substances or elements found in each of the component's parts is below the SJ/T 11363-2006-stipulated requirement.</p> <p>X: The quantity of poisonous or hazardous substances or elements found in at least one of the component's parts is beyond the SJ/T 11363-2006-stipulated requirement.</p> <p>Note: The Environment Friendly Use Period as labeled on this product is applicable under normal usage only</p>						

Table of Contents

Chapter 1 - Product Features, Applications, Specifications.....	1
1.1 Product Features.....	2
1.2 Product Applications.....	2
1.3 Specifications.....	3
Chapter 2 – Hardware Information	5
2.1 Dimensions	6
2.1.1 I/O Location.....	7
2.2 Jumpers and Connectors for the UP-CHT01.....	9
2.3 List of Switches and Connectors for the UP-CHT01.....	10
2.3.1 Power Button (SW1).....	12
2.3.2 RTC Battery Wafer (CN1)	12
2.3.3 USB 3.0 Micro Connector (CN6).....	12
2.3.4 USB 2.0 x 10P Wafer (CN7).....	13
2.3.5 Dual USB Type A Connector 1 (CN8)	14
2.3.6 Dual USB Type A Connector 2 (CN9)	14
2.3.7 RJ-45 LAN Connector (CN10).....	15
2.3.8 HDMI Connector (CN11)	15
2.3.9 HAT 40 GPIO Connector (CN12).....	16
2.3.10 Reset Pin Header (CN14).....	17
2.3.11 DC Jack (CN30).....	17
2.3.12 MIPI DSI Connector (CN31).....	18
2.3.13 MIPI CSI Connector (CN32).....	19
2.3.14 Power Button Wafer (CN33)	19
2.3.15 Update CPLD Header (CN34)	20
2.4 Jumpers and Connectors for the UP-3GHAT01	21
2.5 List of Switches and Connectors for the UP-3GHAT01.....	22

2.5.1	RS-232/422/485 Select Header (JP1/JP2).....	22
2.5.2	Wifi Header (CN1).....	23
2.5.3	BT Header (CN2).....	23
2.5.4	5V IN Header (HAT1).....	23
2.5.5	USB 2.0 Header (USB1).....	24
2.5.6	RS-232/422/485 DB9 Connector (COM1).....	25
2.5.7	RS-232/422/485 Connector (COM2).....	25
2.5.8	SIM Card Connector (SIM1).....	26
2.5.9	Mini PCIe Connector (MINI1).....	26
2.5.10	GPIO/ADC Connector Pin Assignments.....	28
Chapter 3 – Drivers Installation.....		29
3.1	Driver Download and Installation.....	30

Chapter 1

Product Features, Applications, Specifications

1.1 Product Features

- Intel® Atom™ x5-Z8350 SoC
- Onboard 2GB DDR3L Memory, 32GB eMMC Storage
- Gigabit LAN x 1, HDMI x 1
- USB 2.0 x 4, USB 3.0 OTG x 1, COM x 2 (RS-232/422/485 x 2)
- Pre-configured Wi-Fi, Bluetooth, and 4G for Connectivity

1.2 Product Applications

Immensely sophisticated and compact, AAEON AIOT gateway systems are edge devices which deliver faster and more flexible communication to various industrial IoT applications by offering multiple connectivity protocols like BT, WiFi and 3G.

They are ideal for data collection, aggregation, and transmission, and because of their robust design, they can be used in energy metering, smart city deployment, and transportation. Harnessing the power of the IoT in lightweight, palm-sized boxes, AAEON AIOT gateway systems are poised to offer maximum value and communication to cloud-based networks in a smart industrial context.

1.3 Specifications

System

- CPU Intel® Atom™ x5-z8350 SoC
- Chipset Processor integrated
- System Memory Onboard 2GB DDR3L-1600 memory
- Power Requirement 5V DC Only
- Storage 32 GB eMMC on board x 1
- Audio HDMI Audio x 1
- Power Supply Type DC-In
- Power Consumption (Typical) 5DC @ 6A
- Dimensions (L x W) 130 x 95 x 44.2 mm (L x W x H)
- Operating Temperature 0°C ~ 50°C
- Operation Humidity 0% ~ 90% relative humidity, non-condensing
- Certification CE Class A/FCC
- Ethernet Realtek RTL8111G-CG

Display

- **Graphics** Intel® HD 400 Graphics ,12 EU GEN 8, up to 500MHz
Support DX*11.1/12, Open GL*4.2, Open CL*1.2
OGL
ES3.0, H.264, HEVC (decode), VP8

I/O

- **HDMI** HDMI x 1
- **USB** USB2.0 x 4
USB 3.0 OTG x 1
- **COM** COM x 2 (RS-232/422/485) x 2
- **Expansion Slot (Optional)** WiFi 802.11 a/b/g/n/ac
Bluetooth V4.0
Mini PCIe slot for 4G Quectel EC25E (EMEA range)
Micro SIM Socket x 1

Chapter 2

Hardware Information

2.1 Dimensions

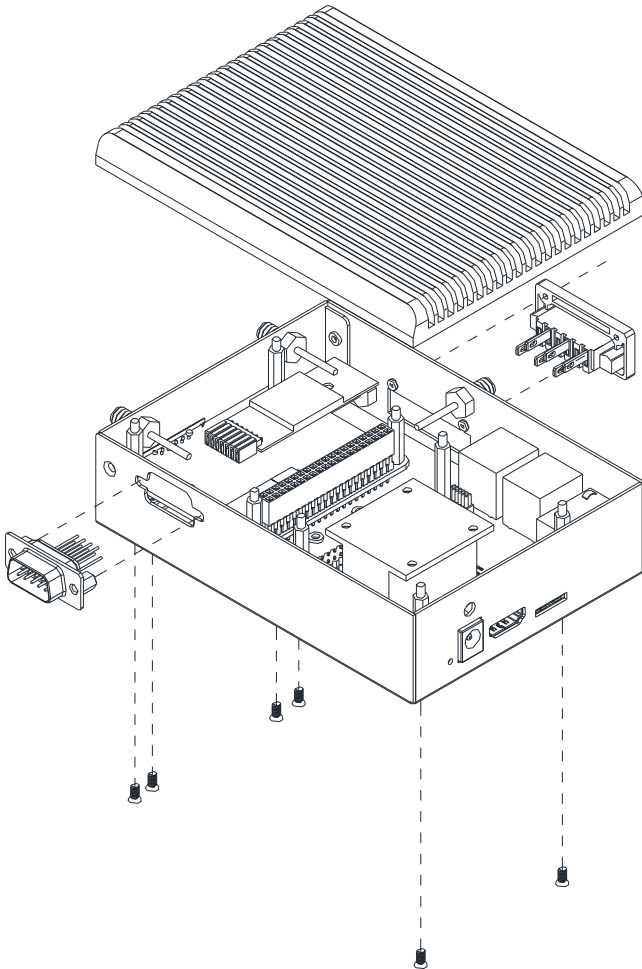

2.1.1 I/O Location

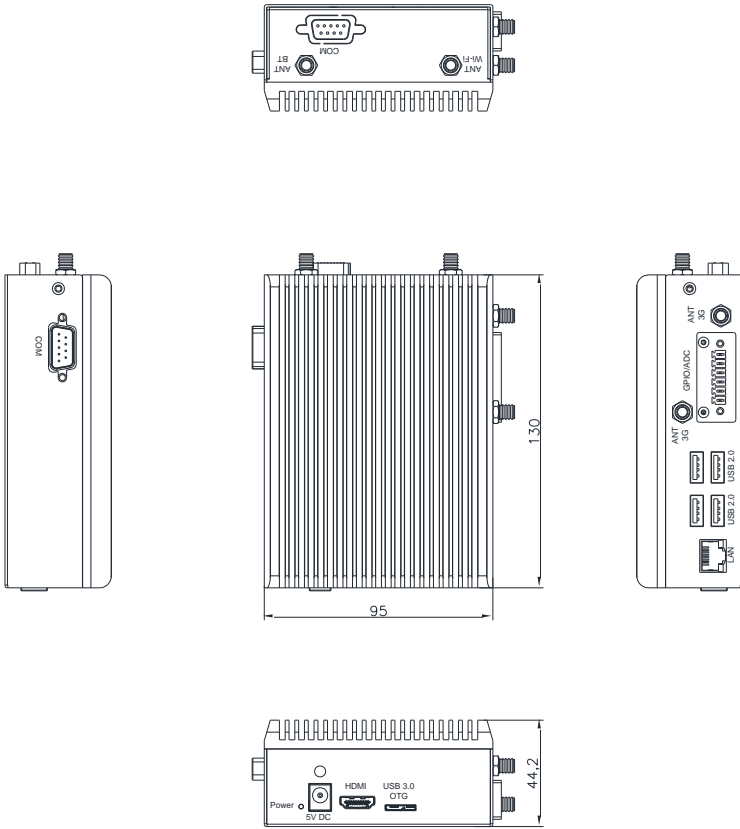

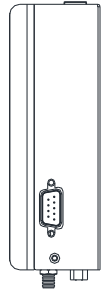
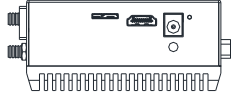
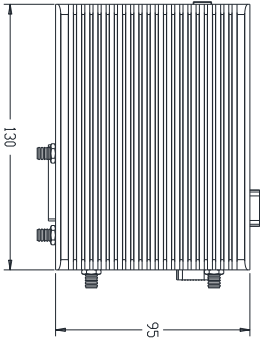
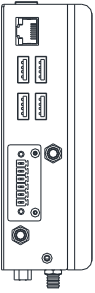

2.2 Jumpers and Connectors for the UP-CHT01

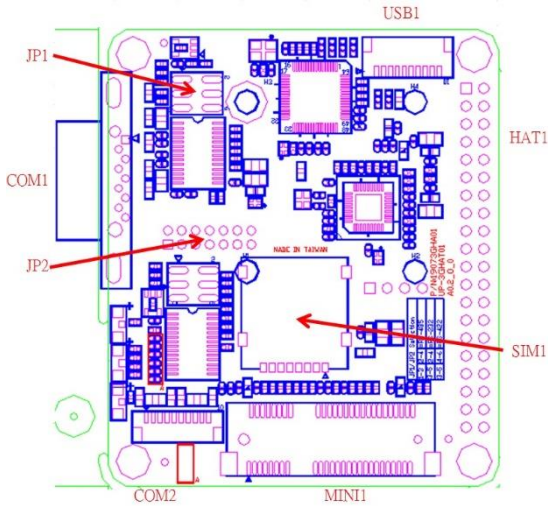
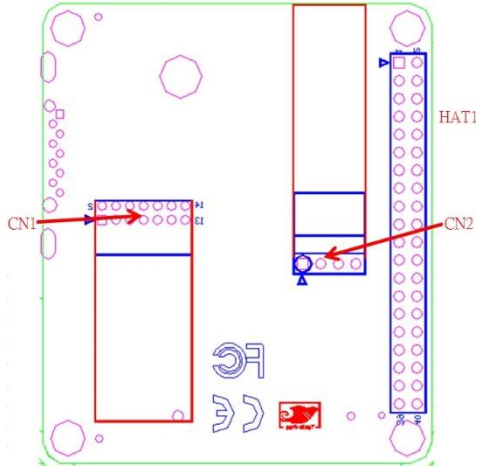

2.3 List of Switches and Connectors for the UP-CHT01

Please refer to the table below for all of the board's jumpers that you can configure for your application.

Label	Function
SW1	Power Button
CN1	RTC Battery Wafer
CN6	USB 3.0 Micro Connector
CN7	USB 2.0 1x10P Wafer
CN8	USB Type A Connector 1
CN9	USB Type A Connector 2
CN10	RJ45 LAN Connector
CN11	HDMI Connector
CN12	HAT 40 GPIO Connector
CN14	Reset Pin Header
CN30	DC Jack
CN31	MIPI DSI Connector
CN32	MIPI CSI Connector
CN33	Power Button Wafer
CN34	Update CPLD Header

Label	Connector Type
SW1	(TF) Push Button Switch.HCH.PTS-099
CN1	(TF) WAFER BOX 2P:180D.1.25mm.CATCH.1201-700-02S
CN6	(TF) Micro USB 3.0 Conn.10P:90D.B-type.ATTEND.209E-BE01
CN7	(TF)Wafer Box.10P:90D.1.0mm.CATCH.1204-700-10RM
CN8	(TF)USB CONNECTOR DUAL PORT.8P:TechBest.KS-002D-ANB(2.0)-L
CN9	(TF)USB CONNECTOR DUAL PORT.8P:TechBest.KS-002D-ANB(2.0)-L
CN10	(TF) RJ45.14P:90D.W/TF & LED.UDE.RB1-1A5BAK1A
CN11	(TF)HDMI CONN.19P:90D(F).A TYPE.FOXCONN.QJ51191-LFB4-7F
CN12	(TF) PIN HEADER.2*20P:180D.(M).2.54mm.DIP
CN14	(TF) PIN HEADER.2*1P:180D.(M).2.0mm.DIP
CN30	(TF)DC Power Jack.3P:90D(M).DIP.2.0mm.COXOC.416AEWTJ02004PA
CN31	(TF)FPC/FFC Conn.41P:90D(F).0.6mm.Hirose.FH35C-41S-0.3SHW(50)
CN32	(TF)FPC/FFC Conn.21P:90D(F).0.6mm.Hirose.FH35C-21S-0.3SHW(50)
CN34	(TF)PIN HEADER.6*2P:180D(M).1.27mm.Astron.C27-4112-206-1G-R
CN33	(TF)WAFER BOX.2P:180D.(M).1.25mm.CATCH.1201-700-02S

2.3.1 Power Button (SW1)

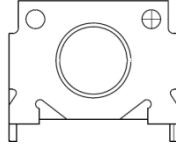

Position	Function
SW10	Power on
SW11	(default)

2.3.2 RTC Battery Wafer (CN1)

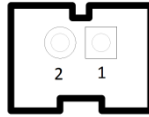

Pin	Signal
1	+V_COIN_BAT
2	GND

2.3.3 USB 3.0 Micro Connector (CN6)

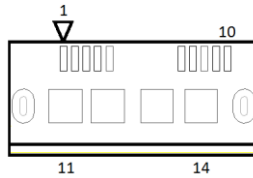

Pin	Signal	Pin	Signal
1	USB_VCC	8	GND
2	USB2_D-	9	CROSSBAR_TX1_N
3	USB2_D+	10	CROSSBAR_TX1_P
4	USB2_ID	11	GND

5	GND	12	GND
6	CROSSBAR_RX1_N	13	GND
7	CROSSBAR_RX1_P	14	GND

2.3.4 USB 2.0 x 10P Wafer (CN7)

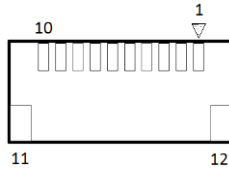

Pin	Signal	Pin	Signal
1	USB_VCC	7	USB_HSIC_P4_D+
2	USB_HSIC_P3_D-	8	GND
3	USB_HSIC_P3_D+	9	UART0_RXD
4	GND	10	UART0_TXD
5	USB_VCC	11	GND
6	USB_HSIC_P4_D-	12	GND

2.3.5 Dual USB Type A Connector 1 (CN8)

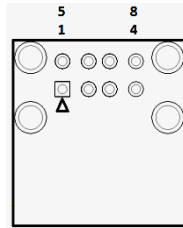

Pin	Signal	Pin	Signal
1	USB_VCC	5	USB_VCC
2	USB2_P1_D-	6	USB2_P2_D-
3	USB2_P1_D+	7	USB2_P2_D+
4	GND	8	GND

2.3.6 Dual USB Type A Connector 2 (CN9)

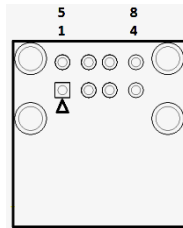

Pin	Signal	Pin	Signal
1	USB_VCC	5	USB_VCC
2	USB2_P3_D-	6	USB_HSIC_P2_D-
3	USB2_P3_D+	7	USB_HSIC_P2_D+
4	GND	8	GND

2.3.7 RJ-45 LAN Connector (CN10)

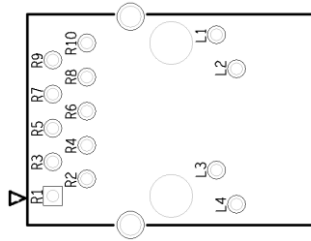

Pin	Signal	Pin	Signal
R1	LAN1_MDI0+	R8	LAN1_MDI2-
R2	LAN1_MDI0-	R9	LAN1_MDI3+
R3	LAN1_MDI1+	R10	LAN1_MDI3-
R4	LAN1_MDI1-	L1	LAN_ACTLED P
R5	LAN1_MDI2+	L2	LAN_ACTLED N
R6	LAN1_MDI2-	L3	LAN_LINK100#
R7	LAN1_MDI2+	L4	LAN_LINK1000#

2.3.8 HDMI Connector (CN11)

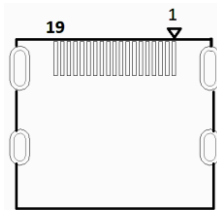

Pin	Signal	Pin	Signal
1	DDI2_TX0_HDMI_DP+	11	GND
2	GND	12	DDI2_CLK_HDMI_DN-
3	DDI2_TX0_HDMI_DN-	13	HDMI_CEC_D

4	DDI2_TX1_HDMI_DP+	14	NC
5	GND	15	DDI2_DDC_CLK
6	DDI2_TX1_HDMI_DN-	16	DDI2_DDC_DAT
7	DDI2_TX2_HDMI_DP+	17	GND
8	GND	18	+5V_HDMI
9	DDI2_TX2_HDMI_DN-	19	DDI2_TYPE_C_HPDP
10	DDI2_CLK_HDMI_DP+		

2.3.9 HAT 40 GPIO Connector (CN12)

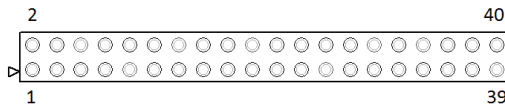

Pin	Signal	Pin	Signal
1	3V3 POWER	2	5V POWER
3	GPIO0/I2C1_SDA	4	5V POWER
5	GPIO1/I2C1_SCL	6	GND
7	GPIO2/ADC-INPUT	8	GPIO15/UART_TX
9	GND	10	GPIO16/UART_RX
11	GPIO3	12	GPIO17/I2S_CLK
13	GPIO4	14	GND
15	GPIO5	16	GPIO18
17	3V3 POWER	18	GPIO19
19	GPIO6/SPI_MOSI	20	GND
21	GPIO7/SPI_MISO	22	GPIO20
23	GPIO8/SPI_CLK	24	GPIO21/SPI_CS0N
25	GND	26	GPIO22/SPI_CS1N
27	GPIO9/I2C0_SDA	28	GPIO23/I2C0_SCL
29	GPIO10	30	GND

31	GPIO11	32	GPIO24/PWM0
33	GPIO12/PWM1	34	GND
35	GPIO13/I2S_FRM	36	GPIO25
37	GPIO14	38	GPIO26/I2S_DATAIN
39	GND	40	GPIO27/I2S_DATAOUT

2.3.10 Reset Pin Header (CN14)

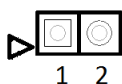

Pin	Signal
1	PMU_RSTBTN_N
2	GND

2.3.11 DC Jack (CN30)

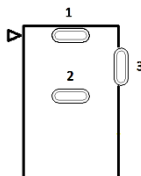

Pin	Signal
1	+V5
2	GND
3	GND

2.3.12 MIPI DSI Connector (CN31)

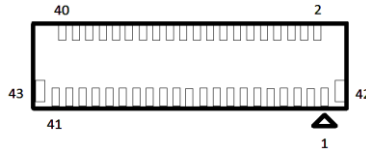

Pin	Signal	Pin	Signal	Pin	Signal
1	MDSI_A_DATA1_DN	16	DDI0_TX0_DP	31	DDI0_HPD_CONN
2	MDSI_A_DATA1_DP	17	DDI0_TX0_DN	32	DDI0_BKLT_R_CTRL
3	GND	18	GND	33	DDI0_VDD_EN
4	MDSI_A_CLK_DN	19	DDI0_TX1_DP	34	DDI0_BKLT_EN
5	MDSI_A_CLK_DP	20	DDI0_TX1_DN	35	NC
6	GND	21	GND	36	NC
7	MDSI_A_DATA0_DN	22	DDI0_TX2_DP	37	+3.3V
8	MDSI_A_DATA0_DP	23	DDI0_TX2_DN	38	+3.3V
9	GND	24	GND	39	+3.3V
10	I2C2_3P3_SCL	25	DDI0_TX3_DP	40	+3.3V
11	I2C2_3P3_SDA	26	DDI0_TX3_DN	41	+3.3V
12	GND	27	GND	42	GND
13	DDI1_DDC_C_CLK	28	DDI0_AUX_DP	43	GND
14	DDI1_DDC_C_DAT	29	DDI0_AUX_DN		
15	GND	30	GND		

2.3.13 MIPI CSI Connector (CN32)

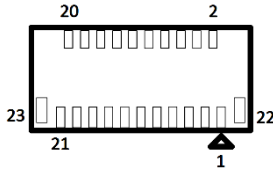

Pin	Signal	Pin	Signal
1	GND	13	GND
2	MCSI_1_DATA1_DN	14	CAM_MCLK
3	MCSI_1_DATA1_DP	15	GND
4	GND	16	I2C2_SOC_SCL
5	MCSI_1_CLK_DN	17	I2C2_SOC_SDA
6	MCSI_1_CLK_DP	18	CAM_RST_N
7	GND	19	FLASH_RESET_N
8	MCSI_1_DATA0_DN	20	+2.8V
9	MCSI_1_DATA0_DP	21	GND_CAM
10	GND	22	GND
11	+1.2V	23	GND
12	+1.8V		

2.3.14 Power Button Wafer (CN33)

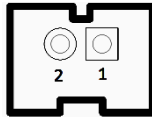

Pin	Signal
1	PWR_SW#_CTL_R
2	GND

2.3.15 Update CPLD Header (CN34)

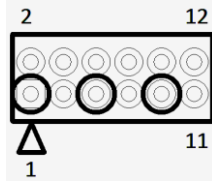

Pin	Signal	Pin	Signal
1	CHT_GPIO_TMS	2	CPLD_TMS
3	CHT_GPIO_TDI	4	CPLD_TDI
5	CHT_GPIO_TCK	6	CPLD_TCK
7	CHT_GPIO_TDO	8	CPLD_TDO
9	FAN_PWM	10	+1.8V
11	+5V	12	GND

2.4 Jumpers and Connectors for the UP-3GHAT01

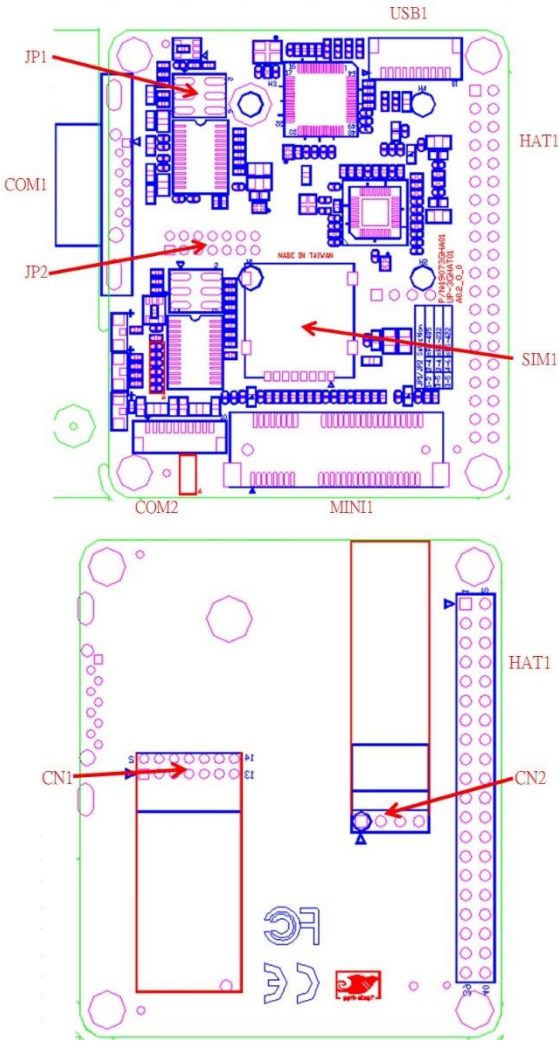

2.5 List of Switches and Connectors for the UP-3GHAT01

Please refer to the table below for all of the board's jumpers that you can configure for your application.

Label	Function	Connector Type
JP1	RS-232/422/485 Select Header	222-97-03GBE1
JP2	RS-232/422/485 Select Header	222-97-03GBE1
CN1	Wifi pin7 Header	22Y8242-14D10B-01G
CN2	BT pin4 Header	22N8561-04R10B-01G
HAT1	5V IN Header	22N8562-40SA2B-01G
USB1	USB 2.0 Header	1204-700-10RM
COM1	RS-232/422/485 DB9 Connector	3117-000-09P
COM2	RS-232/422/485 Connector	1204-700-10SMR
SIM1	SIM Card Connector	80440GIH-081T-12CL
MINI1	Mini PCIe Connector	AS0B226-S68Q-7H

2.5.1 RS-232/422/485 Select Header (JP1/JP2)

Position	Function
3-5, 4-6	RS-422
3-5, 2-4	RS-232 (default)
1-3, 2-4	RS-485

2.5.2 Wifi Header (CN1)

Pin	Signal	Pin	Signal
1	USB2_WF_TX	2	USB2_WF_TX
3	WF_PWM	4	WF_PWM
5	USB2_WF_DN_L	6	USB2_WF_DN_L
7	USB2_WF_PN_L	8	USB2_WF_PN_L
9	GND	10	GND
11	USB2_WF_LED#	12	USB2_WF_LED#
13	NC	14	NC

2.5.3 BT Header (CN2)

Pin	Signal
1	BT_PWM
2	USB2_BT_DN_L
3	USB2_BT_PN_L
4	GND

2.5.4 5V IN Header (HAT1)

Pin	Signal	Pin	Signal
1	+3.3V	2	+5V
3	NC	4	+5V
5	NC	6	GND
7	NC	8	HAT_TXD
9	GND	10	HAT_RXD

11	G_LED	12	NC
13	Y_LED	14	GND
15	NC	16	NC
17	+3.3V	18	NC
19	NC	20	GND
21	NC	22	NC
23	NC	24	NC
25	GND	26	NC
27	NC	28	NC
29	NC	30	GND
31	NC	32	NC
33	NC	34	GND
35	NC	36	NC
37	NC	38	NC
39	GND	40	NC

2.5.5 USB 2.0 Header (USB1)

Pin	Signal
1	USB_VCC
2	USB2_D-
3	USB2_D+
4	GND
5	USB_VCC
6	USB2_D-
7	USB2_D+
8	GND
9	UART0_RXD

10	UART0_TXD
----	-----------

2.5.6 RS-232/422/485 DB9 Connector (COM1)

Pin	Signal
1	DCDA / RS422TX- / RS485-
2	RXA / RS422TX+ / RS485+
3	TXA / RS422RX+
4	DTRA / RS422RX-
5	GND
6	DSRA
7	RTSA
8	CTSA
9	RIA

2.5.7 RS-232/422/485 Connector (COM2)

Pin	Signal
1	DCDB / RS422TX- / RS485-
2	RXB / RS422TX+ / RS485+
3	TXB / RS422RX+
4	DTRB / RS422RX-
5	GND
6	DSRB
7	RTSB
8	CTSB
9	RIB

10	NC
----	----

2.5.8 SIM Card Connector (SIM1)

Pin	Signal Description	Pin	Signal Description
C1	P_UIM_PWRF	C8	NC
C2	P_UIM_RSTC	C7	P_UIM_DATC
C3	P_UIM_CLKC	C6	P_UIM_VPPC
C4	NC	C5	GND_UIM

2.5.9 Mini PCIe Connector (MINI1)

Pin	Signal	Pin	Signal
1	NC	2	P3V_3G
3	NC	4	GND
5	NC	6	NC
7	NC	8	P_UIM_PWR
9	GND	10	P_UIM_DAT
11	NC	12	P_UIM_CLK
13	NC	14	P_UIM_RST
15	GND	16	P_UIM_VPP
17	NC	18	GND
19	NC	20	3G_EN
21	GND	22	3G_RST
23	NC	24	P3V_3G
25	NC	26	GND
27	GND	28	NC

29	GND	30	NC
31	NC	32	NC
33	NC	34	GND
35	GND	36	USB2_HUB1_P1_DN
37	NC	38	USB2_HUB1_P1_DP
39	NC	40	GND
41	NC	42	WLAN_LED
43	NC	44	WLAN_LED
45	NC	46	WLAN_LED
47	NC	48	NC
49	NC	50	GND
51	NC	52	P3V_3G

2.5.10GPIO/ADC Connector Pin Assignments

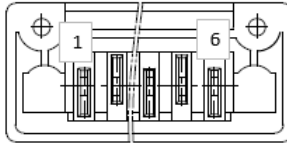

Pin	Signal Description
1	ADC(HAT40 ADC0/GPIO2)
2	GND
3	GPIO1(HAT40 GPIO10)
4	GPIO2(HAT40 GPIO14)
5	GPIO3(HAT40 GPIO25)
6	GND

Remark: If you want to control the CPLD function, please refer to the information in this link: <https://wiki.up-community.org/Ubuntu>

Chapter 3

Drivers Installation

3.1 Driver Download and Installation

Step 1 Basic setup of the system and accessories

Please make sure the following items are properly connected

1. The power adapter in 3A-4A@5V. 5.5/2.1mm DC is properly connected with the system and power outlet
2. The HDMI cable in type A male connector is properly connected with the system and display
3. The keyboard & mouse to control your up board

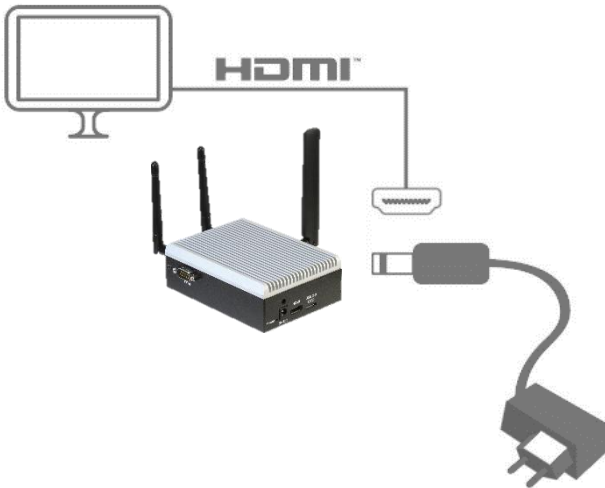

Step 2 Prepare your bootable drive with the operating system of choice

For the Windows 10 operating system:

Step 2.1 Download the Windows 10 operating system

Please prepare a bootable USB with MS Windows 10 Installer follow this link:

<https://www.microsoft.com/en-us/software-download/windows10>

Remark :

Please noted that the MS Windows license is not included; you can buy a license from the Microsoft Store or from your sales representative.

Step 2.2

Please use the following link to download a driver for the Windows 10 operating system

<https://downloads.up-community.org/download/microsoft-windows-10-64-bit-drivers/>

Remark:

Windows 10 drivers installation guides are available at:

<https://downloads.up-community.org/download/up-board-windows-10-installation-guide/>

For Linux Ubuntu 16.04:

Please follow the steps on <https://wiki.up-community.org/Ubuntu> to install Linux Ubuntu 16.04 and driver

Step 3 Install 3G HAT driver

Step 3.1 Download 3G HAT driver per operating system in the following link

https://up-shop.org/up-peripherals/125-3gwifibtmodule.html?search_query=3G+HAT&results=5

Step 4 Download driver for optional connection module

Step 4.1 download WIFI driver

Please access www.aaeon.com to download WIFI driver

Step 4.2 Download Bluetooth driver

Please access