

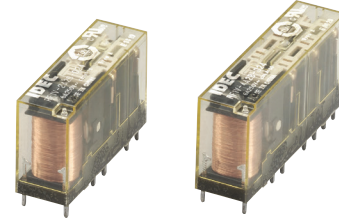



RF1V Force Guided Relays/SF1V Relay Sockets

Key features:

- Compact and EN compliant RF1V force guided relays
- Force guided contact mechanism (EN50205 Type A TÜV approved)
- Contact configuration
4-pole (2NO-2NC, 3NO-1NC)
6-pole (4NO-2NC, 5NO-1NC, 3NO-3NC)
- Built-in LED indicator model and Counter Electromotive force diode models
- Fast response time (8 ms maximum).
- High shock resistance (200 m/s² minimum)
- Finger-safe DIN rail mount socket and PC board mount soc





Applicable Standard	Marking	Certification Organization/ File Number
UL508		UL recognized File No. E55996
CSA C22.2 No.14		CSA File No. 253350
EN50205 EN61810-1		TÜV SÜD





Part Number Selection

		Part Number			
Contact	Rated Coil Voltage	Without LED Indicator	With LED Indicator	Counter-Electromotive Force	
4-pole	2NO-2NC	12V DC	RF1V-2A2B-D12	RF1V-2A2BL-D12	RF1V-2A2BLD1-D12
		24V DC	RF1V-2A2B-D24	RF1V-2A2BL-D24	RF1V-2A2BLD1-D24
		48V DC	RF1V-2A2B-D48	RF1V-2A2BL-D48	RF1V-2A2BLD1-D48
	3NO-1NC	12V DC	RF1V-3A1B-D12	RF1V-3A1BL-D12	RF1V-3A1BLD1-D12
		24V DC	RF1V-3A1B-D24	RF1V-3A1BL-D24	RF1V-3A1BLD1-D24
		48V DC	RF1V-3A1B-D48	RF1V-3A1BL-D48	RF1V-3A1BLD1-D48
6-pole	4NO-2NC	12V DC	RF1V-4A2B-D12	RF1V-4A2BL-D12	RF1V-4A2BLD1-D12
		24V DC	RF1V-4A2B-D24	RF1V-4A2BL-D24	RF1V-4A2BLD1-D24
		48V DC	RF1V-4A2B-D48	RF1V-4A2BL-D48	RF1V-4A2BLD1-D48
	5NO-1NC	12V DC	RF1V-5A1B-D12	RF1V-5A1BL-D12	RF1V-5A1BLD1-D12
		24V DC	RF1V-5A1B-D24	RF1V-5A1BL-D24	RF1V-5A1BLD1-D24
		48V DC	RF1V-5A1B-D48	RF1V-5A1BL-D48	RF1V-5A1BLD1-D48
	3NO-3NC	12V DC	RF1V-3A3B-D12	RF1V-3A3BL-D12	RF1V-3A3BLD1-D12
		24V DC	RF1V-3A3B-D24	RF1V-3A3BL-D24	RF1V-3A3BLD1-D24
		48V DC	RF1V-3A3B-D48	RF1V-3A3BL-D48	RF1V-3A3BLD1-D48

Sockets

Style	No. of Poles	Ordering Type No.
 DIN Rail Mount Sockets	4	SF1V-4-07L
	6	SF1V-6-07L
 PC Board Mount Sockets	4	SF1V-4-61
	6	SF1V-6-61

Certification for Sockets

Applicable Standard	Marking	Certification Organization/ File Number
UL508		UL recognized File No. E62437
CSA C22.2 No.14		CSA File No. 253350
EN147000 EN147100		TÜV SÜD
		EC Low Voltage Directive (DIN rail mount sockets only)

Coil Ratings

Contact	Rated Coil Voltage (V)	Rated Current (mA) ±10% (at 20°C) ¹	Coil Resistance (Ω) ±10% (at 20°C)	Operating Characteristics (at 20°C)			Power Consumption			
				Pickup Voltage	Dropout Voltage	Maximum Continuous Applied Voltage ²				
4-pole	2NO-2NC	12V DC	30	75% maximum	10% minimum	110%	Approx. 0.36W			
		24V DC	15							
		48V DC	7.5							
	3NO-1NC	12V DC	30							
		24V DC	15							
		48V DC	7.5							
6-pole	4NO-2NC	12V DC	41.7				75% maximum	10% minimum	110%	Approx. 0.5W
		24V DC	20.8							
		48V DC	10.4							
	5NO-1NC	12V DC	41.7							
		24V DC	20.8							
		48V DC	10.4							
	3NO-3NC	12V DC	41.7							
		24V DC	20.8							
		48V DC	10.4							



- For relays with LED indicator, the rated current increases by approx. 2 mA.
- Maximum continuous applied voltage is the maximum voltage that can be applied to relay coils.

Accessories

Item	Appearance	Specifications	Type No.	Remarks
DIN Rail		Aluminum Weight: Approx. 250g	BNDN1000	Length: 1m Width: 35 mm
End Clip		Metal (zinc plated steel) Weight: Approx. 15g	BNL5	—
			BNL6	

Specifications

Number of Poles	4-pole		6-pole		
Contact Configuration	2NO-2NC	3NO-1NC	4NO-2NC	5NO-1NC	3NO-3NC
Contact Resistance (initial value) ¹	100 mΩ maximum				
Contact Material	AgSnO ₂ (Au flashed)				
Rated Load (resistive load)	6A 250V AC, 6A 30V DC				
Allowable Switching Power (resistive load)	1500 VA, 180W				
Allowable Switching Voltage	250V AC, 30V DC				
Allowable Switching Current	6A				
Minimum Applicable Load ²	5V DC, 1 mA (reference value)				
Power Consumption (approx.)	0.36W		0.5W		
Insulation Resistance	1000 MΩ minimum (500V DC megger, same measurement positions as the dielectric strength)				
Dielectric Strength	Between contact and coil	4000V AC, 1 minute			
	Between contacts of different poles	2500V AC, 1 minute Between contacts 7-8 and 9-10	2500V AC, 1 minute Between contacts 7-8 and 11-12 Between contacts 9-10 and 13-14 Between contacts 11-12 and 13-14		
		4000V AC, 1 min. Between contacts 3-4 and 5-6 Between contacts 3-4 and 7-8 Between contacts 5-6 and 9-10	4000V AC, 1 min. Between contacts 3-4 and 5-6 Between contacts 3-4 and 7-8 Between contacts 5-6 and 9-10 Between contacts 7-8 and 9-10		
	Between contacts of the same pole	1500V AC, 1 minute			
Operating Time (at 20°C)	20 ms maximum (at the rated coil voltage, excluding contact bounce time)				
Response Time (at 20°C) ³	8 ms maximum (at the rated coil voltage, excluding contact bounce time)				
Release Time (at 20°C)	20 ms maximum (at the rated coil voltage, excluding contact bounce time)				
Vibration Resistance	Operating Extremes	10 to 55 Hz, amplitude 0.75 mm			
	Damage Limits	10 to 55 Hz, amplitude 0.75 mm			
Shock Resistance	Operating Extremes (half sine-wave pulse: 11 ms)	200 m/s ² , when mounted on DIN rail mount socket: 150 m/s ²			
	Damage Limits (half sine-wave pulse: 6 ms)	1000 m/s ²			
Electrical Life	250V AC 6A resistive load: 100,000 operations minimum (operating frequency 1200 per hour) 30V DC 6A resistive load: 100,000 operations minimum (operating frequency 1200 per hour) 250V AC 1A resistive load: 500,000 operations minimum (operating frequency 1800 per hour) 30V DC 1A resistive load: 500,000 operations minimum (operating frequency 1800 per hour) [AC 15] 240V AC 2A inductive load: 100,000 operations minimum (operating frequency 1200 per hour, cos φ = 0.3) [DC 13] 24V DC 1A inductive load: 100,000 operations minimum (operating frequency 1200 per hour, L/R = 48 ms)				
Mechanical Life	10 million operations minimum (operating frequency 10,800 operations per hour)				
Operating Temperature ⁴	-40 to +85°C (no freezing)				
Operating Humidity	5 to 85%RH (no condensation)				
Storage Temperature	-40 to +85°C				
Operating Frequency (rated load)	1200 operations per hour				
Weight (approx.)	20g		23g		



1. Measured using 6V DC, 1A voltage drop method.
2. Failure rate level P (reference value)

3. Response time is the time until NO contact opens, after the coil voltage is turned off.
4. When using at 70 to 85°C, reduce the switching current by 0.1A/°C.

Socket Specifications

Part Number	SF1V-4-07L	SF1V-6-07L	SF1V-4-61	SF1V-6-61
Rated Current	6A			
Rated Voltage	250V AC/DC			
Insulation Resistance	1000 MΩ minimum (500V DC megger, between terminals)			
Dielectric Strength	2500V AC, 1 minute (between terminals)			
Screw Terminal Style	M3 slotted Phillips screw		—	
Applicable Wire	0.7 to 1.65 mm ² (18 AWG to 14 AWG)		—	
Recommended Screw Tightening Torque	0.5 to 0.8 N·m		—	
Terminal Strength	Wire tensile strength: 50N min.		—	
Vibration Resistance	Damage limits: 10 to 55 Hz, amplitude 0.75 mm Resonance: 10 to 55 Hz, amplitude 0.75 mm			
Shock Resistance	1000 m/s ²			
Operating Temperature ¹	-40 to +85°C (no freezing)			
Operating Humidity	5 to 85% RH (no condensation)			
Degree of Protection	IP20 (finger-safe screw terminals)		—	
Weight (approx.)	40g	55g	9g	10g

 1. When using at 70 to 85°C, reduce the switching current by 0.1A/°C.

Applicable Crimping Terminals Specifications

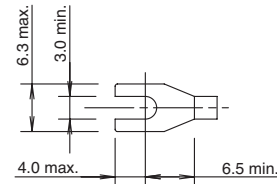

 Note: Ring tongue terminals cannot be used.

Characteristics

Maximum Switching Capacity



Electrical Life Curve

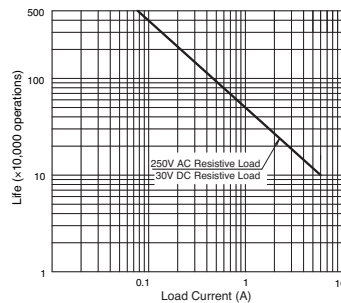

Notes on Contact Gaps except Welded Contacts

Example: RF1V-2A2B-D24

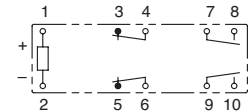

- If the NO contact (7-8 or 9-10) welds, the NC contact (3-4 or 5-6) remains open even when the relay coil is de-energized, maintaining a gap of 0.5 mm. The remaining unwelded NO contact (9-10 or 7-8) is either open or closed.
- If the NC contact (3-4 or 5-6) welds, the NO contact (7-8 or 9-10) remains open even when the relay coil is energized, maintaining a gap of 0.5 mm. The remaining unwelded NC contact (5-6 or 3-4) is either open or closed.

Switches & Pilot Lights

Signaling Lights

Relays & Sockets

Timers

Contactors

Terminal Blocks

Circuit Breakers

RF1V Dimensions (mm)

RF1V (4-pole)

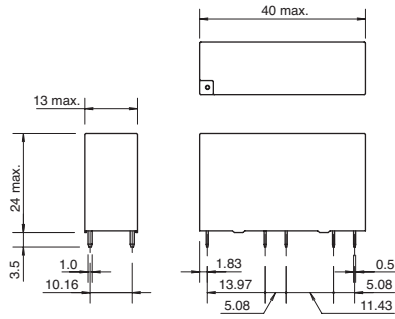

RF1V (6-pole)

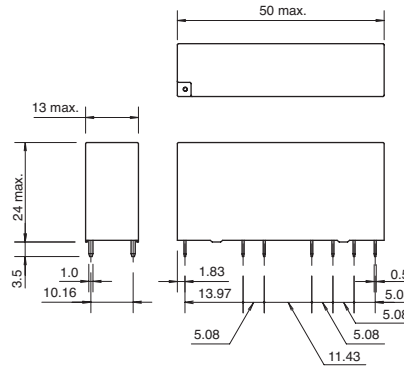

PC Board Terminal type Mounting Hole Layout (Bottom View)

RF1V (4-pole)

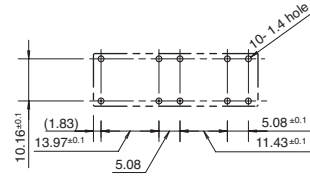

RF1V (6-pole)

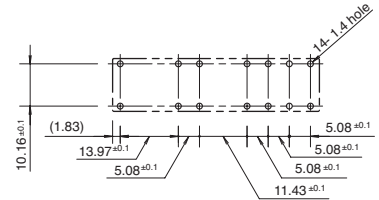

Internal Connection (View from Bottom)
With Indicator and Diode (-LD type)

RF1V (4-pole)

Without LED Indicator

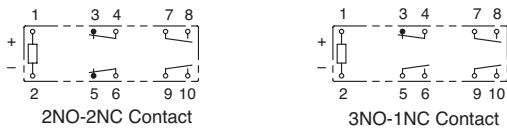

RF1V (6-pole)

Without LED Indicator

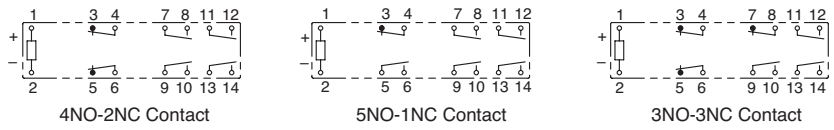

With LED Indicator

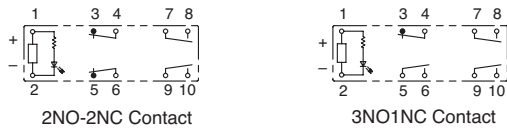

With LED Indicator

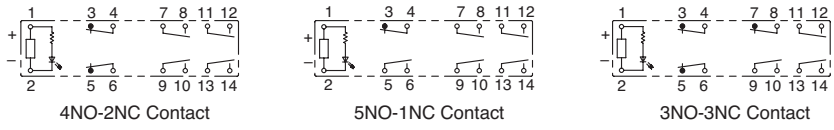

With Counter-electromotive Force Diode

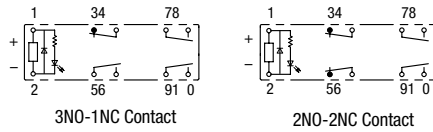

With Counter-electromotive Force Diode

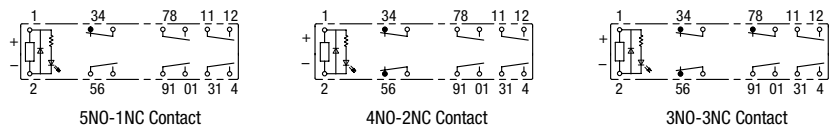

Switches & Pilot Lights

Signaling Lights

Relays & Sockets

Timers

Contactors

Terminal Blocks

Circuit Breakers

SF1V DIN Rail Mount Socket Dimensions (mm)

SF1V-4-07L (4-pole)

(Internal Connection)

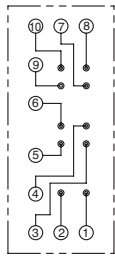

(Top View)

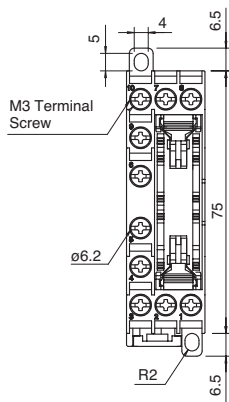

SF1V-6-07L (6-pole)

(Internal Connection)

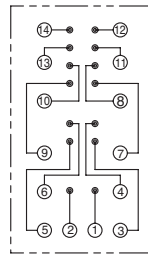

(Top View)

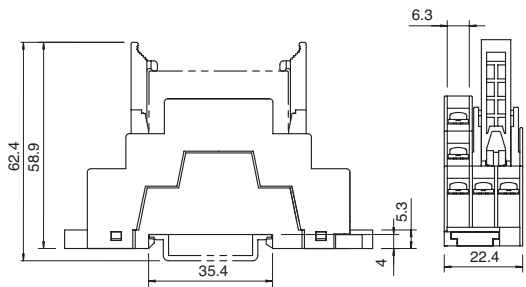
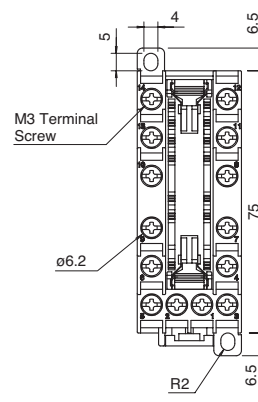

(Panel Mounting Hole Layout)

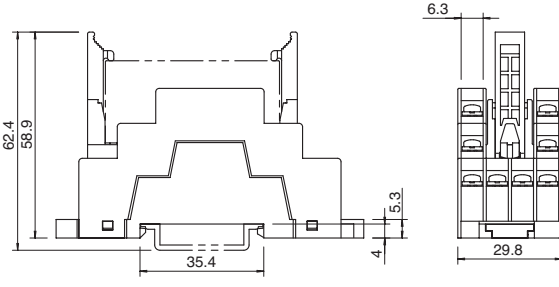

(Panel Mounting Hole Layout)

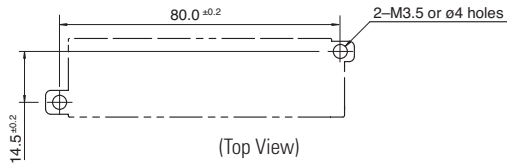

(Top View)

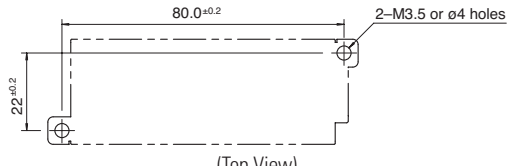

(Top View)

SF1V PC Board Mount Sockets

SF1V-4-07L (4-pole)

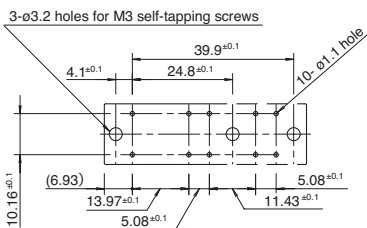
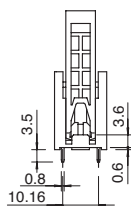
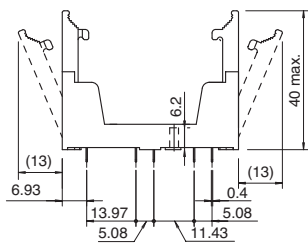
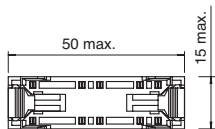

SF1V-6-07L (6-pole)

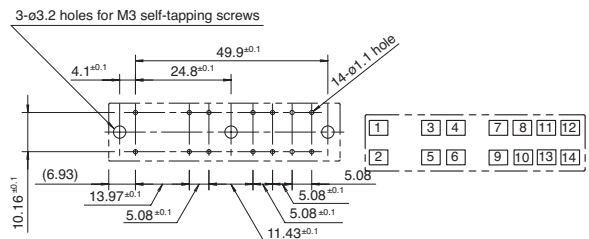
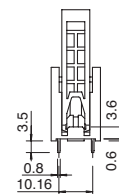
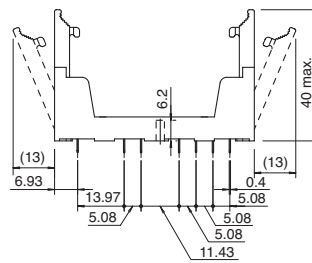
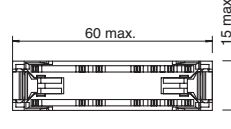

Switches & Pilot Lights

Signaling Lights

Relays & Sockets

Timers

Contactors

Terminal Blocks

Circuit Breakers

RF2V 2-Pole Force Guided Relays/SJ Series Relay Sockets

Key features:

- 2-pole force guided relay to reduce cost and installation space.
- Force guided contact mechanism (EN50205 Type A TÜV approved).
- Reinforced insulation between coil and contact and contacts of different poles.
- Mechanical indicator shows contact status.
- Two terminal styles - socket mounting and PC board mounting.
- RTIII degree of protection, LED, diode models available.
- Can be used with SJ series relay socket.
- Applicable Standards Mark Certification

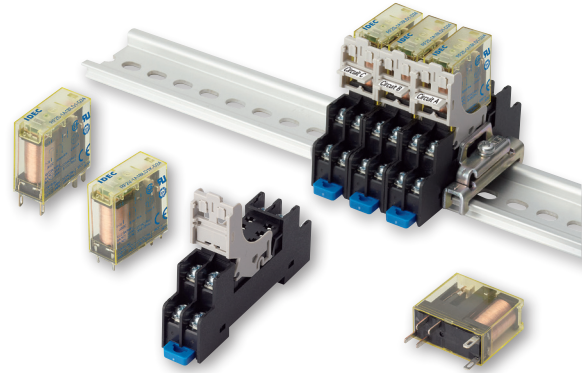

Applicable Standard	Marking	Certification Organization/ File Number
UL60947-4-1a		UL/Recognition File No. E55996
CSA C22.2 No.14		CSA File No. LR35144
EN50205 EN61810-1		TÜV SÜD
		EU Low Voltage Directive

Part Numbers

Contact Configuration	Terminal Style	LED Indicator	w/Diode	Degree of Protection (Note)		Rated Coil Voltage	Part No.	
				Flux-tight (RTII)	Sealed (RTIII)			
2-pole SPST-NO + SPST-NC	Plug-in	With	√	√		12V DC	RF2S-1A1BLD1-D12	
		Without	—	√		24V DC	RF2S-1A1B-D24	
		With	√	√			RF2S-1A1BD1-D24	
			√		√		RF2S-1A1BLD1-D24	
		Without	—	√			RF2S-1A1B-D48	
		With	√	√		48V DC	RF2S-1A1BLD1-D48	
	√			√		RF2S-1A1BLD1K-D48		
	PC Board	Without	—	—	√		12V DC	RF2V-1A1B-D12
			—	—	√		RF2V-1A1B-D24	
			—	—		√		RF2V-1A1BK-D24
			√	√		24V DC	RF2V-1A1BD1-D24	
		With	√		√		RF2V-1A1BD1K-D24	
			√		√		RF2V-1A1BLD1K-D24	
		Without	—	—	√		48V DC	RF2V-1A1B-D48
Without		—	—	√		24V DC	RF2V-2C-D24	

Switches & Pilot Lights

Signalng Lights

Relays & Sockets

Timers

Contactors

Terminal Blocks

Circuit Breakers