

RF2040E

**915.0 MHz
SAW Filter**

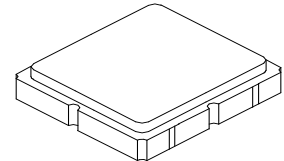

SM3030-8

- **Designed for 902.0 - 928.0 MHz Applications**
- **Optimized for use with the TRC103 Transceiver**
- **Balanced 150 ohm IC Interface**
- **Complies with Directive 2002/95/EC (RoHS)**
- **Tape and Reel Standard per ANSI/EIA-481**
- **Moisture Sensitivity Level: 1**

Absolute Maximum Ratings

Rating	Value	Units
Input Power Level	+15	dBm
DC Voltage	±5	V
Operating Temperature Range	-40 to +85	°C
Storage Temperature Range in Tape and Reel	-40 to +85	°C
Soldering Temperature (10 seconds / 5 cycles maximum)	260	°C

Electrical Characteristics

Characteristic	Sym	Notes	Min	Typ	Max	Units
Center Frequency	f_c			915.0		MHz
1 dB Bandwidth	BW_1			31		MHz
Maximum Insertion Loss, 902.0 to 928.0 MHz	IL_{MAX}			2.0	3.0	dB
Amplitude Ripple, p-p, 902.0 to 928.0 MHz				0.7	1.0	
Rejection Referenced to Insertion Loss at 915.0 MHz:						
710 to 810 MHz			37	40		
810 to 860 MHz			37	40		
1010 to 1060 MHz			37	40		
1060 to 1110 MHz			43	45		
1110 to 1210 MHz			45	48		
Source Impedance	Z_S			50		Ω
Load Impedance	Z_L			130		Ω

Case Style	SM3030-8 3.0 x 3.0 mm Nominal Footprint					
Lid Symbolization (Y=year, WW=week, S=shift) dot=pin 1 indicator	804, <u>YWWS</u>					
Standard Reel Quantity	Reel Size 7 Inch					1000 Pieces/Reel
	Reel Size 13 Inch					3000 Pieces/Reel

Electrical Connections

Connection	Terminals
Single-ended Port	6
Balanced Port	1, 3
Case Ground	4, 5, 7, 8
No Connection	2

CAUTION: Electrostatic Sensitive Device. Observe precautions for handling.

NOTES:

1. The design, manufacturing process, and specifications of this device are subject to change.
2. US or International patents may apply.
3. RoHS compliant from the first date of manufacture.

RF2040E-TRC103 Application Circuit

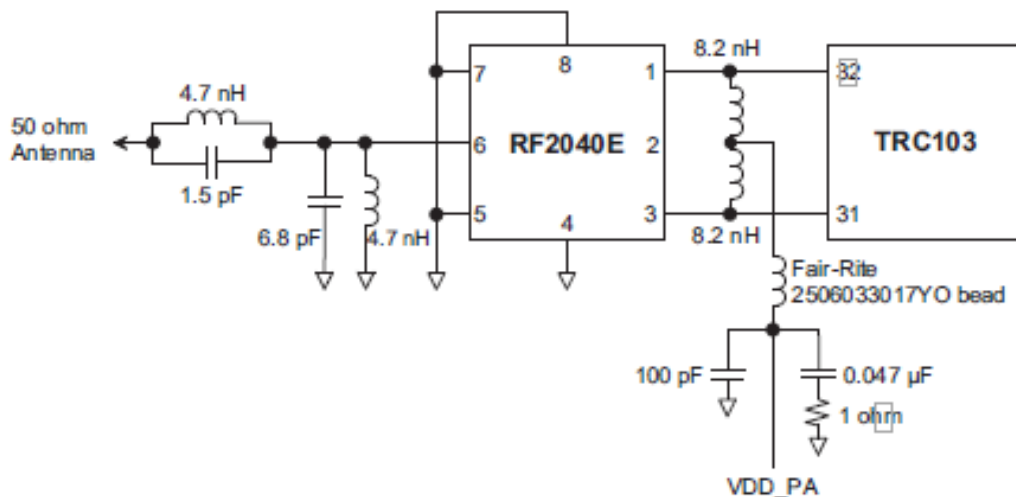

RF2040E 50 Ohm Tuning Network

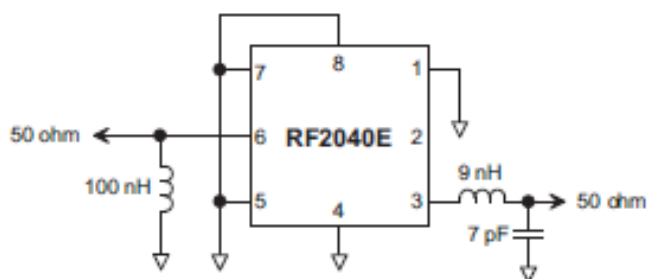

RF2040E Broadband Response, 200 to 2000 MHz

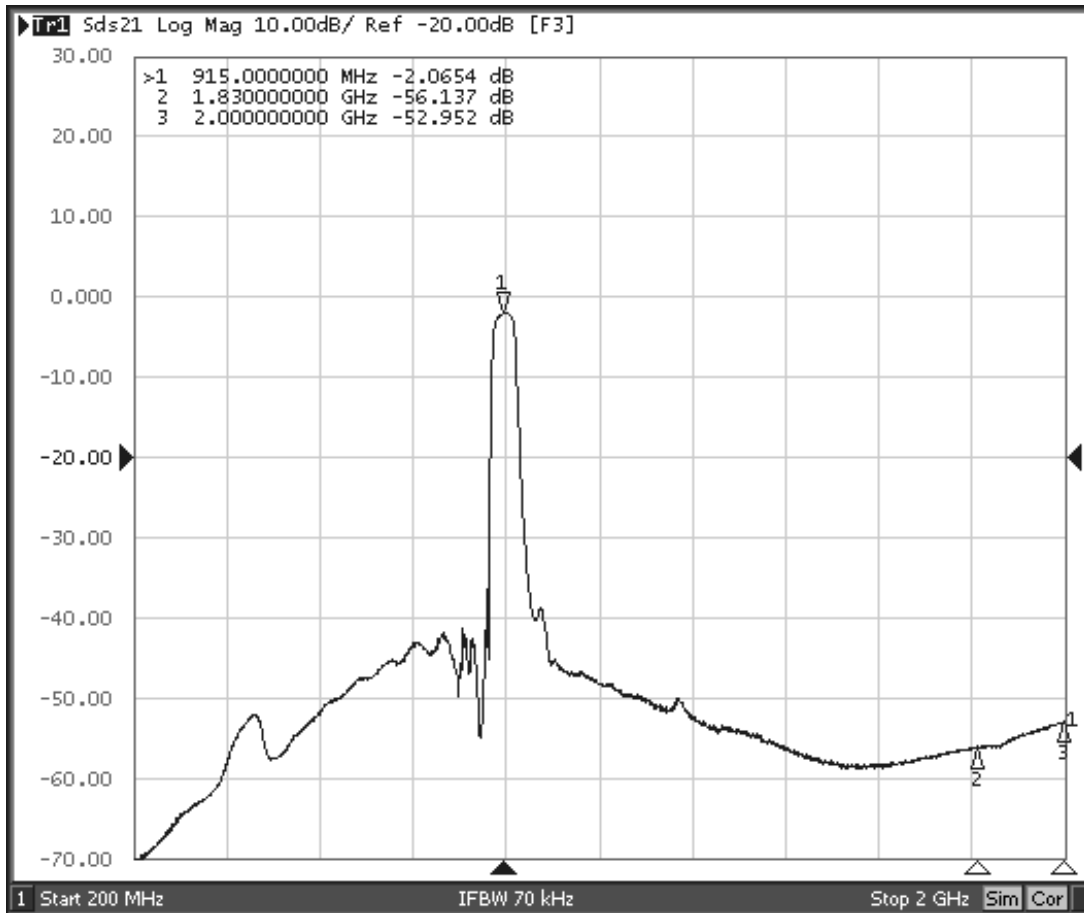

RF2040E Response, 815.0 to 1015.0 MHz

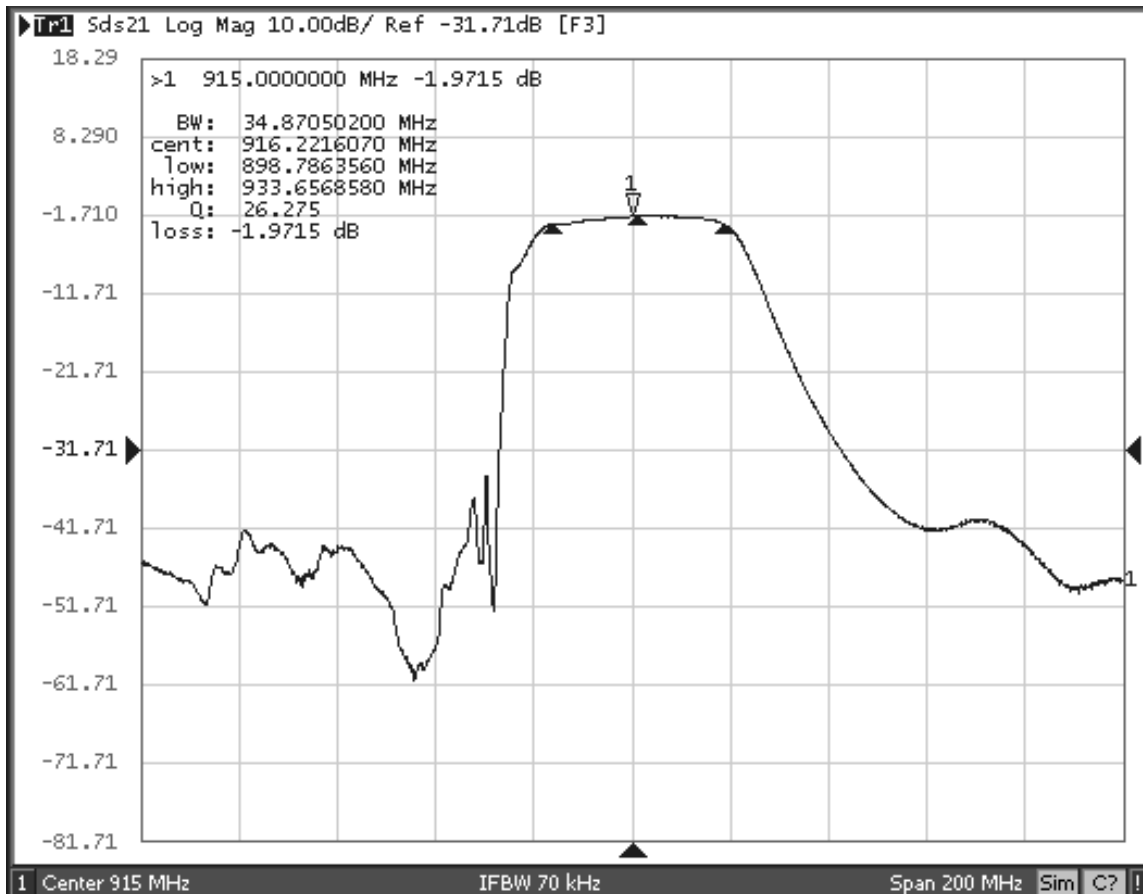

RF2040E Response, 865.0 to 965.0 MHz

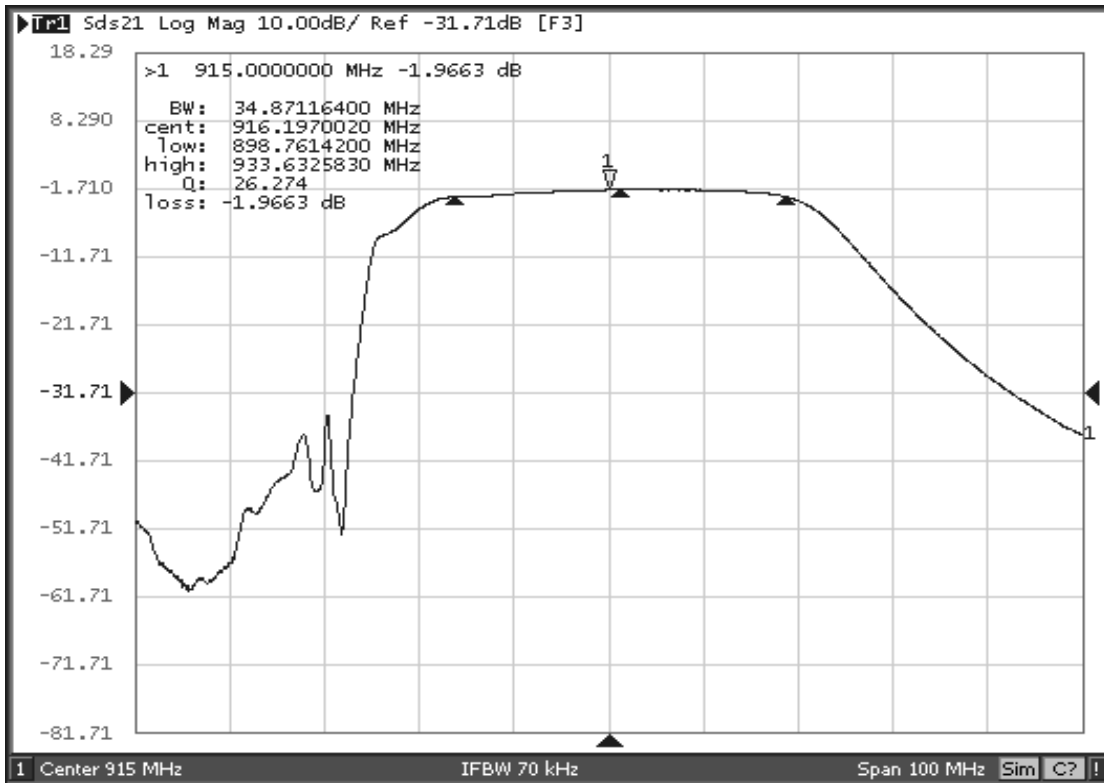

RF2040E Passband Response

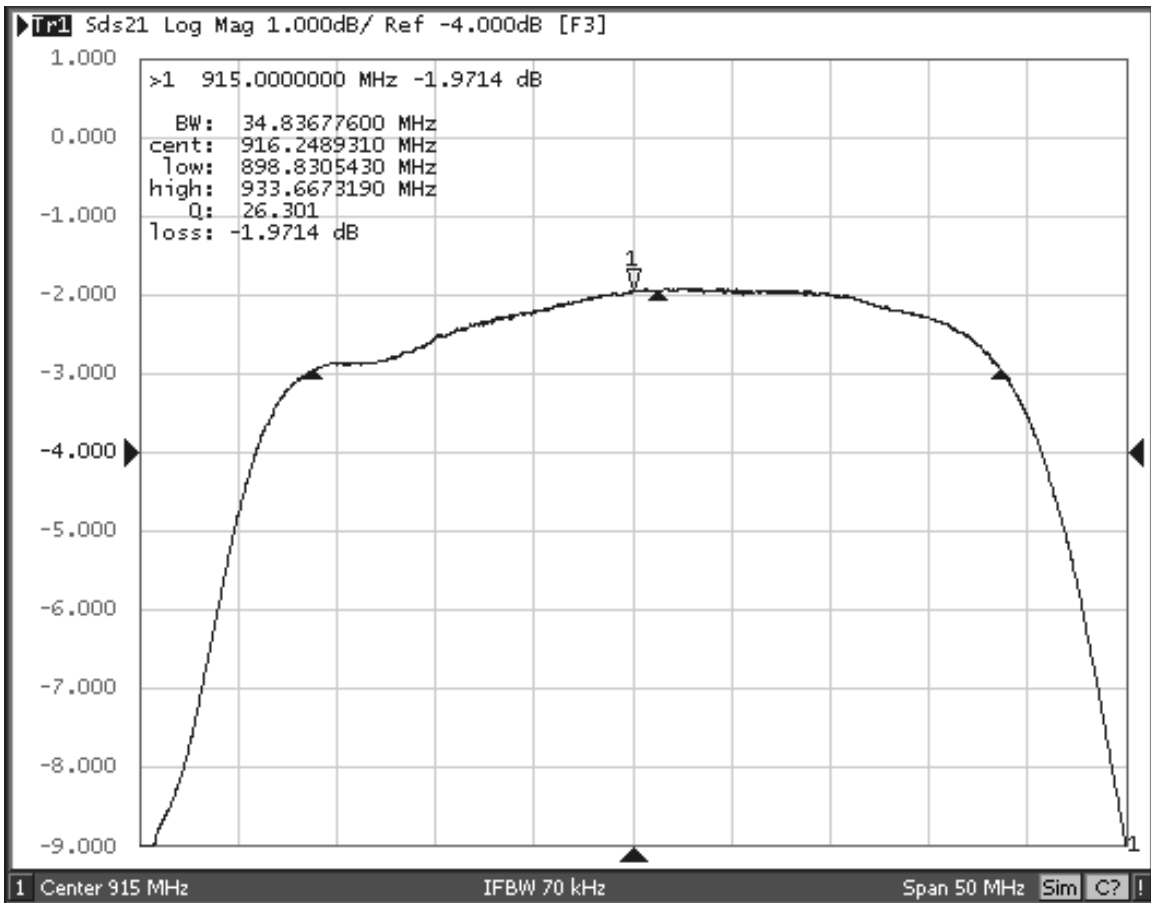

RF2040E Input Impedance Plot

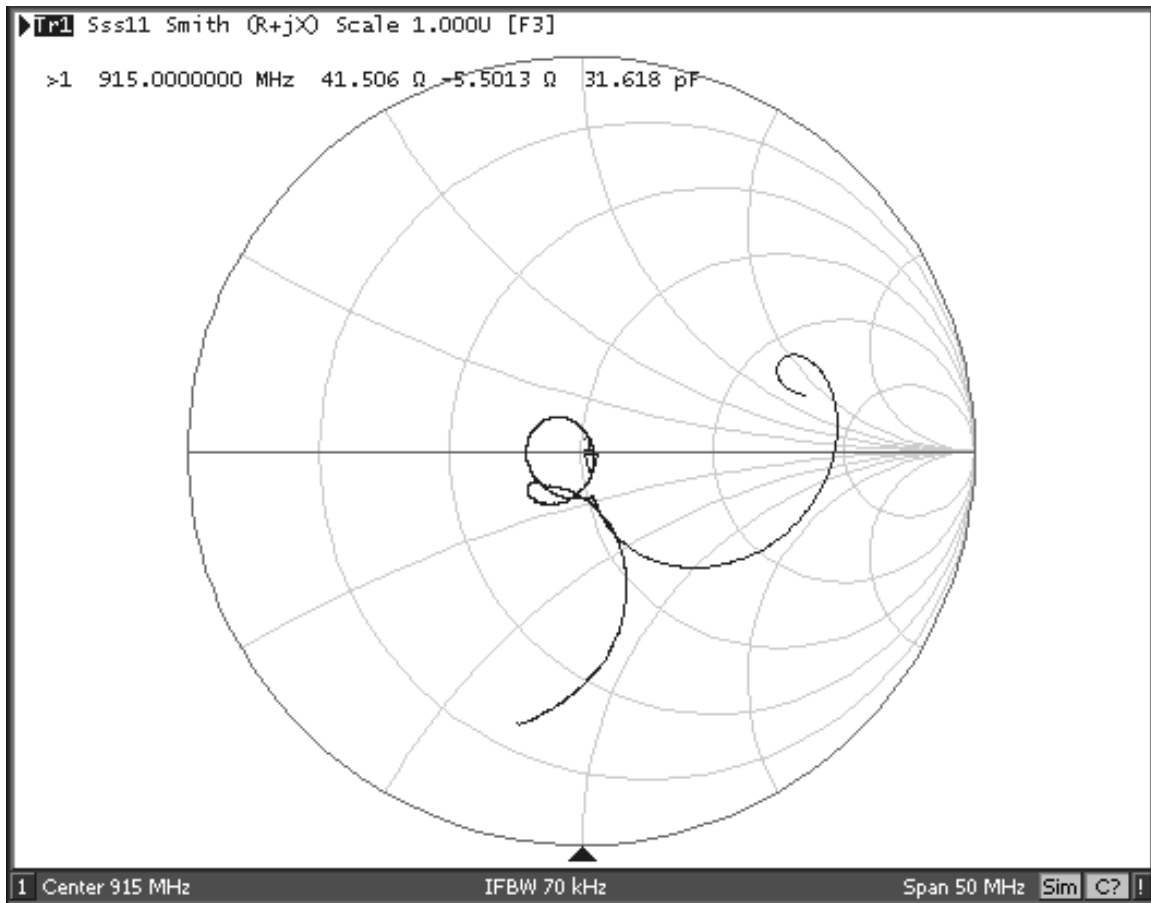

RF2040E Balanced Output Impedance Plot

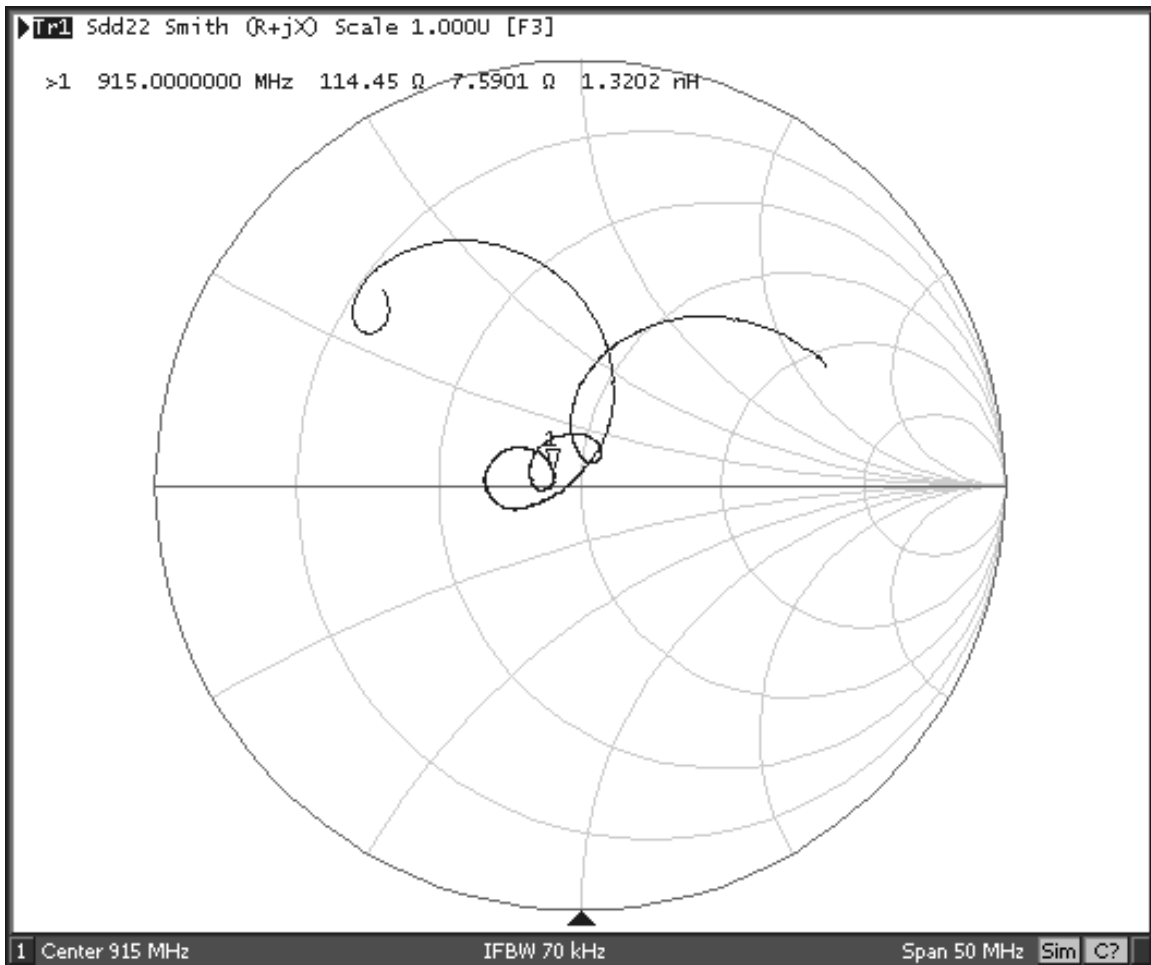

8-Terminal Ceramic Surface-Mount Case 3.0 X 3.0 mm Nominal Footprint

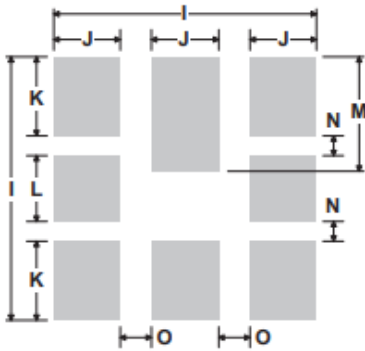
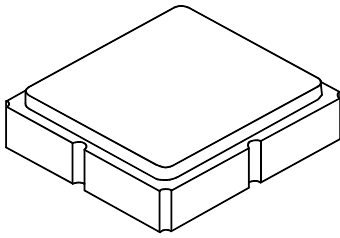

PCB Footprint Top View

Case and PCB Footprint Dimensions

Dimension	mm			Inches		
	Min	Nom	Max	Min	Nom	Max
A	2.87	3.0	3.13	0.113	0.118	0.123
B	2.87	3.0	3.13	0.113	0.118	0.123
C	1.14	1.27	1.40	0.045	0.050	0.055
D	0.79	0.92	1.05	0.031	0.036	0.041
E	0.62	0.75	0.88	0.024	0.029	0.034
F	0.47	0.60	0.73	0.018	0.024	0.029
G	0.47	0.60	0.73	0.018	0.024	0.029
H	1.07	1.20	1.33	0.042	0.047	0.052
I		3.19			0.126	
J		0.81			0.032	
K		0.96			0.038	
L		0.81			0.032	
M		1.39			0.055	
N		0.23			0.009	
O		0.38			0.015	

Case Materials

Materials	
Solder Pad Plating	0.3 to 1.0 μm Gold over 1.27 to 8.89 μm Nickel
Lid Plating	2.0 to 3.0 μm Nickel
Body	Al_2O_3 Ceramic
Pb Free	

TOP VIEW

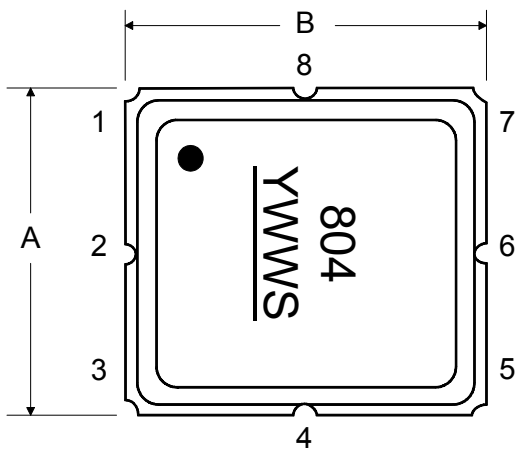

BOTTOM VIEW

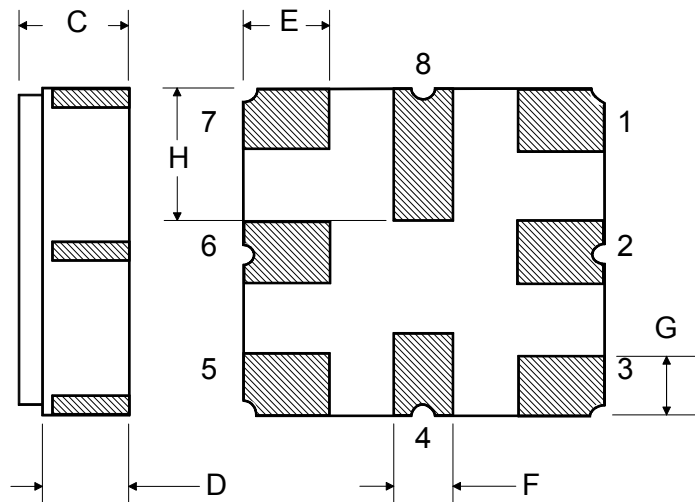

Tape and Reel Specifications

Tape and Reel Standard per ANSI/EIA-481

"B "		Quantity Per Reel
Nominal Size		
Inches	millimeters	
7	178	1000
13	330	3000

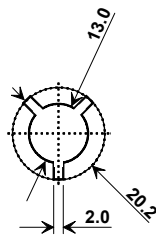
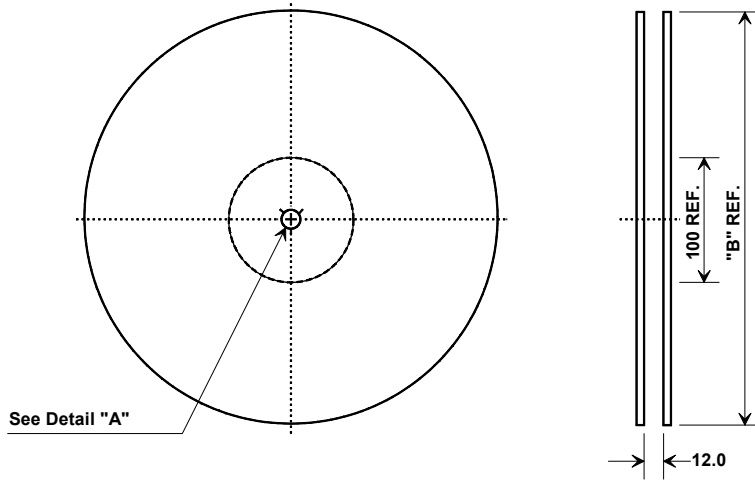

Carrier Tape Dimensions	
Ao	3.35 mm
Bo	3.35 mm
Ko	1.4 mm
Pitch	8.0 mm
W	12.0 mm

COMPONENT ORIENTATION and DIMENSIONS

