



Features

- Low Noise and High Intercept Point
- Adjustable Bias Current
- Power Down Control
- Single 2.7V to 5.0V Power Supply
- 0.4GHz to 4 GHz Operation
- SOT 5-Lead Package

Applications

- WiFi LNA/Driver
- GPS LNA
- CDMA PCS LNA
- Low Noise Transmit Power Amplifier
- General Purpose Amplification
- Driver Amplifier for TX Power Amplifier

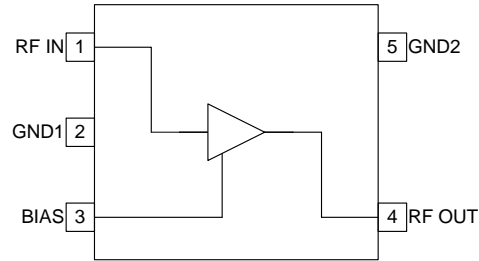

Functional Block Diagram

Product Description

The RF2373 is a low noise amplifier with a high dynamic range designed for WiFi, WiMAX, and digital cellular applications. The device functions as an outstanding front end low noise amplifier or driver amplifier in the transmit chain of digital subscriber units where low transmit noise power is a concern. When used as an LNA, the bias current can be set externally. When used as a PA driver, the IC can operate directly from a single cell Li-ion battery and includes a power down feature that can be used to completely turn off the device. The IC is featured in a standard SOT 5-lead plastic package.

Ordering Information

RF2373	Standard 25 piece bag
RF2373SR	Standard 100 piece reel
RF2373TR7	Standard 2500 piece reel
RF2373PCK-414	Fully Assembled Evaluation Board and 5 loose sample pieces

Optimum Technology Matching® Applied

- | | | | |
|--|--------------------------------------|-------------------------------------|-----------------------------------|
| <input checked="" type="checkbox"/> GaAs HBT | <input type="checkbox"/> SiGe BiCMOS | <input type="checkbox"/> GaAs pHEMT | <input type="checkbox"/> GaN HEMT |
| <input type="checkbox"/> GaAs MESFET | <input type="checkbox"/> Si BiCMOS | <input type="checkbox"/> Si CMOS | |
| <input type="checkbox"/> InGaP HBT | <input type="checkbox"/> SiGe HBT | <input type="checkbox"/> Si BJT | |

RF MICRO DEVICES®, RFMD®, Optimum Technology Matching®, Enabling Wireless Connectivity™, PowerStar®, POLARIS™ TOTAL RADIO™ and UltimateBlue™ are trademarks of RFMD, LLC. BLUETOOTH is a trademark owned by Bluetooth SIG, Inc., U.S.A. and licensed for use by RFMD. All other trade names, trademarks and registered trademarks are the property of their respective owners. ©2006, RF Micro Devices, Inc.

Absolute Maximum Ratings

Parameter	Rating	Unit
Supply Voltage	-0.5 to +6.0	V _{DC}
Bias Voltage, V _{BIAS}	≤V _{CC}	V _{DC}
Input RF Level at F<2.3GHz	+5 (see note)	dBm
Input RF Level at F>2.3GHz	+10 (see note)	dBm
Current Drain, I _{CC}	32	mA
Operating Ambient Temperature	-40 to +85	°C
Storage Temperature	-40 to +150	°C

NOTE: Exceeding any one or a combination of the above maximum rating limits may cause permanent damage. Input RF transients to +15dBm will not harm the device. For sustained operation at inputs ≥+5dBm, a small dropping resistor is recommended in series with the V_{CC} in order to limit the current due to self-biasing to <32mA. Furthermore, while the LNA is in Bypass Mode, and for sustained operation at the input, +10dBm is the maximum recommended power level for Frequencies above 2300MHz. +5dBm is the maximum recommended power level for Frequencies <2300MHz.



Caution! ESD sensitive device.

Exceeding any one or a combination of the Absolute Maximum Rating conditions may cause permanent damage to the device. Extended application of Absolute Maximum Rating conditions to the device may reduce device reliability. Specified typical performance or functional operation of the device under Absolute Maximum Rating conditions is not implied.

RoHS status based on EU Directive 2002/95/EC (at time of this document revision).

The information in this publication is believed to be accurate and reliable. However, no responsibility is assumed by RF Micro Devices, Inc. ("RFMD") for its use, nor for any infringement of patents, or other rights of third parties, resulting from its use. No license is granted by implication or otherwise under any patent or patent rights of RFMD. RFMD reserves the right to change component circuitry, recommended application circuitry and specifications at any time without prior notice.

Parameter	Specification			Unit	Condition
	Min.	Typ.	Max.		
Overall					25 °C, V _{CC} =3.3V, at typical frequencies unless otherwise specified
Supply Voltage (V _{CC})	2.7	3.3	5.0	V	
Bias Voltage (V _{BIAS})	2.7	3.3	5.0	V	
RF Frequency Range	400		3800	MHz	
Power Down Current			10	μA	V _{BIAS} =0V
Isolation		23		dB	
Current Drain (LNA)	8	14	19	mA	Bias Resistor (R1)=560Ω
IP2		55		dBm	
Cellular Low Noise Amplifier					
Frequency	820	880	960	MHz	
Gain		21.5		dB	
Noise Figure		1.1		dB	
IIP3		-1		dBm	
IP1dB		-11		dBm	
GPS Low Noise Amplifier					
Frequency		1575		MHz	
Gain		19.0		dB	
Noise Figure		1.1		dB	
IIP3		5		dBm	
IP1dB		-6		dBm	

Parameter	Specification			Unit	Condition
	Min.	Typ.	Max.		
W-CDMA Low Noise Amplifier					
Frequency Range	1920	2045	2170	MHz	
Gain		17.5		dB	
Noise Figure		1.2		dB	
IIP3		8		dBm	
IP1dB		-6		dBm	
WiFi Low Noise Amplifier					
Frequency	2400	2450	2500	MHz	
Gain	13.0	15.0	17.0	dB	
Noise Figure		1.3	1.5	dB	
IIP3	7.5	9.5		dBm	
Input P1dB		-3.5		dBm	
WiMAX Low Noise Amplifier					
Frequency	3100	3500	3800	MHz	
Gain		12.5		dB	
Noise Figure		1.5		dB	
IIP3		10		dBm	
Input P1dB		3		dBm	
W-CDMA Driver					
Frequency Range	1920	2045	2170	MHz	V _{CC} =5.0V
Gain		17.5		dB	
Noise Figure		1.3		dB	
OIP3		25		dBm	
OP1dB		14		dBm	
WiFi Driver					
Frequency	2400	2450	2500	MHz	V _{CC} =5.0V
Gain		15.5		dB	
Noise Figure		1.4	1.6	dB	
OIP3		25		dBm	
OP1dB		14		dBm	

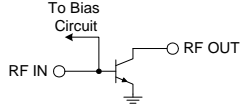
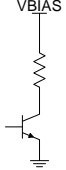
Pin	Function	Description	Interface Schematic
1	RF IN	RF input pin. This pin is DC coupled.	
2	GND1	Ground connection. For best performance, keep traces physically short and connect immediately to ground plane.	
3	BIAS	This pin is used to control the bias current. An external resistor can be used to set the bias current for any V_{BIAS} voltage. See table with evaluation board schematic.	
4	RF OUT	Amplifier output pin. This pin is an open-collector output. It must be biased to V_{CC} through a choke or matching inductor. This pin is typically matched to 50Ω with a shunt bias/matching inductor and series blocking/matching capacitor. Refer to application schematics.	
5	GND2	Ground connection. For best performance, keep traces physically short and connect immediately to ground plane.	

Package Drawing SOT 5-Lead

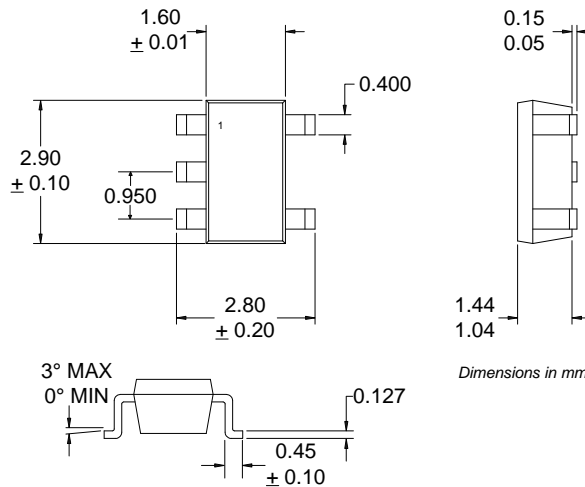

Evaluation Board Schematic

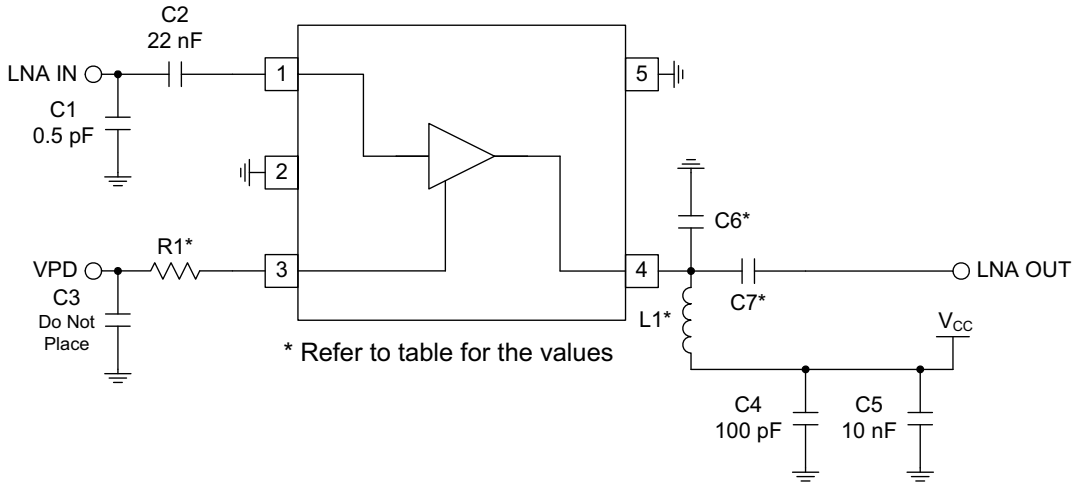

Component	Cellular 900 MHz	GPS 1575 MHz	PCS 1950 MHz	W-CDMA 2140 MHz	WiFi 2450 MHz
L1 (nH)	3.9	2.7	2.7	2.7	2.2
C6 (pF)	4.3	1.5	0.5	DNP	DNP
C7 (pF)	2.0	1.2	1.0	1.0	1.0

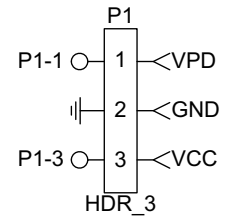

V _{PD}	I _{CC} R1 = 300 Ω	I _{CC} R1 = 430 Ω	I _{CC} R1 = 560 Ω	I _{CC} R1 = 1 kΩ	I _{CC} R1 = 1.5 kΩ
2.7	12	9	7	5	4
3.0	16	12	9	6	5
3.3	20	15	11	7	5
3.6	25	19	14	8	6
4.0	31	24	18	10	7
4.5	Over Limit	31	23	13	8
5.0	Over Limit	Over Limit	29	16	10

Note: V_{CC} set to 3.3 V. I_{CC} only slightly dependent on V_{CC}.

WiBRO/WiFi DATA

IIP3 at WiFi Band in High Gain Mode
 $V_{CC}=3.3V$ and $V_{REF}=3.3V$ Over Temp

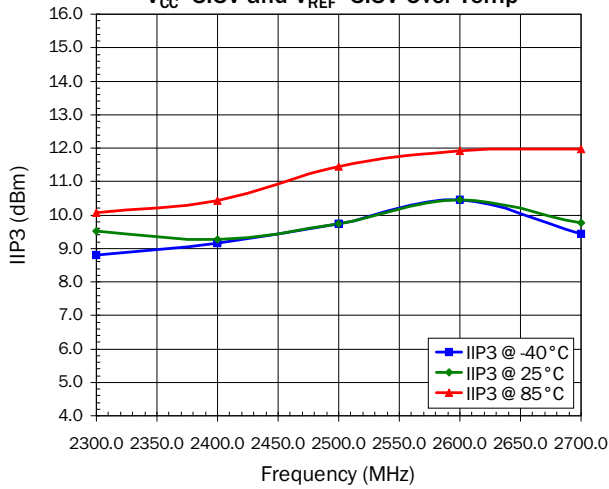

$I_{CC}+I_{REF}$ at WiFi Band in High Gain Mode
 $V_{CC}=3.3V$ and $V_{REF}=3.3V$ Over Temp

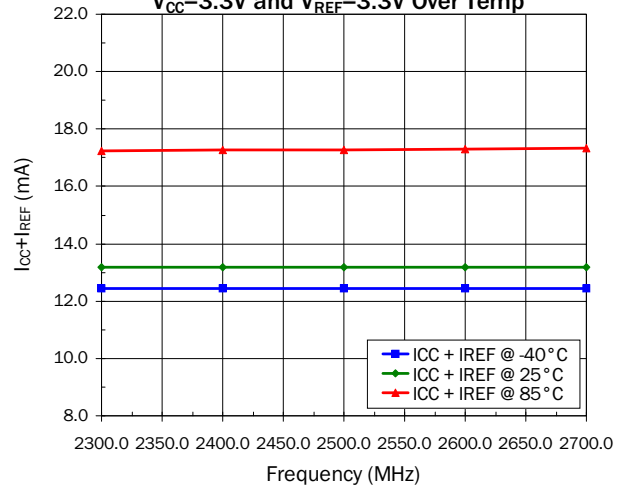

Gain at WiFi Band in High Gain Mode
 $V_{CC}=3.3V$ and $V_{REF}=3.3V$ Over Temp

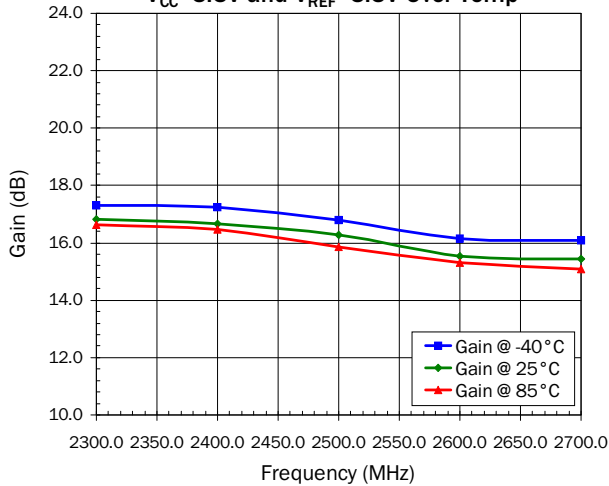

Noise Figure at WiFi Band in High Gain Mode
 $V_{CC}=3.3V$ and $V_{REF}=3.3V$ Over Temp

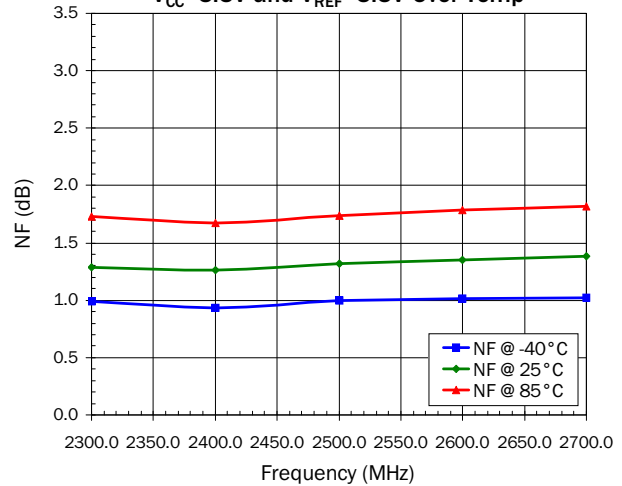

WiMAX DATA

