

# RF2 2-pole Force Guided Relay / SJ Series Socket

For simple and easy safety measures - reduce costs and installation space.

- 2-pole force guided relay to reduce cost and installation space.
- Force guided contact mechanism (EN50205 Type A TÜV approved).
- Reinforced insulation between coil and contact and contacts of different poles.
- Mechanical indicator shows contact status.
- Two terminal styles - socket mounting and PC board mounting.
- RTIII degree of protection, LED, diode models available.
- Can be used with SJ series relay socket.



Applicable Standards	Mark	Certification Organization /File No.
UL60947-4-1A		UL/Recognition File No. E55996
CSA C22.2 No.14		CSA File No. LR35144
EN50205 EN61810-1		TUV SUD
		EU Low Voltage Directive

## Force Guided Relays

Contact Configuration	Terminal Style	LED Indicator	w/Diode	Degree of Protection (Note)		Rated Coil Voltage	Part No.	
				Flux-tight (RTII)	Sealed (RTIII)			
2-pole SPST-NO + SPST-NC	Plug-in	With	✓	✓		12V DC	RF2S-1A1BLD1-D12	
		Without	—	✓		24V DC	RF2S-1A1B-D24	
		With	✓	✓			RF2S-1A1BD1-D24	
		Without	—	✓	✓		RF2S-1A1BLD1K-D24	
		With	✓	✓	✓		RF2S-1A1BD1K-D24	
		Without	—	✓		48V DC	RF2S-1A1B-D48	
	With	✓	✓	✓	48V DC	RF2S-1A1BD1-D48		
	With	✓	✓	✓	48V DC	RF2S-1A1BD1K-D48		
	PC Board	Without	—	—	✓		12V DC	RF2V-1A1B-D12
			—	—	✓		12V DC	RF2V-1A1B-D24
			—	—	✓	✓	24V DC	RF2V-1A1BK-D24
		With	✓	✓	✓	24V DC	RF2V-1A1BD1-D24	
		With	✓	✓	✓	24V DC	RF2V-1A1BD1K-D24	
		Without	—	—	✓		48V DC	RF2V-1A1B-D48
DPDT	Without	—	—	✓	24V DC	RF2V-2C-D24		

• Other part numbers are available. See below (contact IDEC for details).

## Part No. Development

RF	2	S	-	1A1B	LD1	K	-	D24
Series	No. of Poles	Terminal Style		Contact Configuration	Option	Degree of Protection		Rated Coil Voltage
	2 2-pole	S Plug-in V PC Board		1A1B SPST-NO + 2C DPDT	Blank Standard L With LED indicator D With diode (Note 1) D1 With diode of reverse polarity coil (Note 2) LD With LED indicator & diode (Note 1) LD1 With LED indicator & diode of reverse polarity coil (Note 2)	Blank RTII K RTIII		D12 12V DC D24 24V DC D48 48V DC

Note 1: With diode: terminal 1 -, terminal 8 +

Note 2: With diode of reverse polarity coil: terminal 1 +, terminal 8 -

Note 3: Use this chart for interpreting part numbers. Not all possible variations can be realized.

## Ratings

### Coil ratings

Rated Voltage (V)	Rated Current (mA) ±15% (at 20°C)		Coil Resistance ±10% (at 20°C)		Operating Characteristics (against rated values at 20°C)			Power Consumption
	Without LED	With LED	Without LED	With LED	Minimum Pickup Voltage	Dropout Voltage	Maximum Continuous Applied Voltage	
12V DC	58	63	205	205	75% maximum	10% minimum	110%	Approx. 0.7W
24V DC	29	33	820	820				
48V DC	14.6	18	3300	3300				

Note: Maximum continuous applied voltage is the maximum voltage that can be applied to relay coils.

### Standard Ratings

Voltage	UL Rating Resistive		CSA Rating Resistive		Voltage	TÜV Rating Resistive	
	NO	NC	NO	NC		NO	NC
277V AC	6A	3A	6A	3A	240VAC	6A	3A
30V DC	6A	3A	6A	3A	24V DC	6A	3A

# RF2 2-pole Force Guided Relay / SJ series Socket

## Specifications

Model		RF2S (Plug-in Terminal)	RF2V (PC board terminal)
No. of Poles		2-pole	
Contact Configuration		SPST-NO + SPST-NC, DPDT	
Disconnecting Means		Micro disconnection	
Contact Resistance (Note 1)		100mΩ maximum	
Contact Material		AgNi+Au-Clad	
Degree of Protection		RTII (flux-tight), RTIII (sealed)	
Rated Load (resistive load)		NO contact: 240V AC, 6A/24V DC, 6A NC contact: 240V AC, 3A/24V DC, 3A	
Contact	Maximum Allowable Power (resistive load)	NO contact: 1440VA/144W, NC contact: 720VA/72W	
	Maximum Allowable Voltage	250V AC, 125V DC	
	Maximum Allowable Current	6A	
Minimum Applicable Load (Note 2)		1V DC, 1mA	
Power Consumption		Approx. 0.7W	
Rated Insulation Voltage		250V	
Insulation Resistance		1000MΩ minimum (500V megger)	
Impulse Withstand Voltage		6000V	
Pollution Degree		2	
Dielectric Strength	Between contact and coil	5000V AC, 1 minute	
	Between contacts of the same pole	4000V AC, 1 minute	
	Between contacts of the different poles	1500V AC, 1 minute	
Operating Time		15ms max. (at the rated coil voltage, excluding contact bounce time)	
Response Time (Note 3)		5ms max. (at the rated coil voltage, without diode) 20ms max. (at the rated coil voltage, with diode)	
Release Time		10ms max. (at the rated coil voltage, excluding contact bounce time, without diode) 25ms max. (at the rated coil voltage, excluding contact bounce time, with diode)	
Vibration Resistance	Operating Extremes	NO contact: 10 to 55Hz, amplitude 0.75mm NC contact: 10 to 55Hz, amplitude 0.2mm	
	Damage Limits	10 to 55Hz, amplitude 0.75mm	
Shock Resistance	Operating Extremes	NO contact: 100m/s <sup>2</sup> , NC contact: 50m/s <sup>2</sup>	
	Damage Limits	1000m/s <sup>2</sup>	
Electrical Life		NO contact: 100,000 operations minimum (operating frequency 1,800 per hour) at 240V 6A resistive load or 2A inductive load (power factor 0.4) 100,000 operations minimum (operating frequency 1,800 per hour) at 24V 6A resistive load or 1A inductive load (time constant 48ms) NC contact: 100,000 operations minimum (operating frequency 1,800 per hour) at 240V AC, 3A resistive load or 2A inductive load (power factor 0.4) 100,000 operations minimum (operating frequency 1,800 per hour) at 24V DC, 3A resistive load or 1A inductive load (time constant 48ms)	
Mechanical Life		10 million operations minimum (operating frequency 18,000 operations per hour)	
Operating Temperature		Single mounting: -40 to +70°C (no freezing) Collective mounting: -40 to +55°C (no freezing)	-40 to +70°C (no freezing)
Operating Humidity		5 to 85%RH (no condensation)	
Storage Temperature		-40 to +85°C (no freezing)	
Weight (approx.)		18g (without LED/diode), 20g (with LED/with diode/with LED & diode)	



• Above values are initial values.

Note 1: Measured using 5V DC, 1A voltage drop method.

Note 2: Failure rate level P, reference value

Note 3: Response time is the time until NO contact opens, after the coil voltage is turned off.

## Socket Standards & Certification

Applicable Standards	Mark	Certification Organization/File No.
UL508		UL Recognition File No. E62437
CSA C22.2 No.14		CSA File No. LR84913
EN60999-1 (Note 1) EN60664-1 (Note 2)		EU Low Voltage Directive

Note 1: Fingersafe screw terminal only.

Note 2: PC board terminal only.

Note: Sockets can be used on RF2S (Plug-in terminal) only.

## Sockets

### DIN-rail Socket

Terminal Style	No. of Poles	Terminal No. Marking Color	Part No.
Standard Screw Terminal	2	White	<b>SJ2S-05BW</b>
Fingersafe Screw Terminal			<b>SJ2S-07LW</b>

• Release lever is supplied with the socket.

### PC Board Socket

No. of Poles	Part No.
2	<b>SJ2S-61</b>

• Release lever is supplied with the socket.

# RF2 2-pole Force Guided Relay / SJ Series Socket

## Socket Specifications

Model	SJ2S-05B/-07L		SJ2S-61	
Mounting	DIN Rail		PC Board	
Rated Current	8A			
Rated Insulation Voltage	250V AC/DC			
Applicable Wire	2mm <sup>2</sup>		-	
Applicable Crimping Terminal	See dimensions below		-	
Recommended Tightening Torque	0.6 to 1.0 N-m		-	
Screw Terminal Style	M3 slotted Phillips screw (self-lifting)		-	
Terminal Strength	Wire tensile strength: 50N minimum		-	
Dielectric Strength (Note)	Between contact and coil	4000V AC, 1 minute	5000V AC, 1 minute	
	Between contacts of the same pole	1000V AC, 1 minute		
	Between contacts of the different pole	3000V AC, 1 minute		
Vibration Resistance	Damage limits	90m/s <sup>2</sup>		
	Resonance	Frequency 10 to 55Hz, amplitude 0.75mm		
Shock Resistance (damage limits)	1000m/s <sup>2</sup>			
Operating Temperature	-40 to +70°C (no freezing)			
Operating Humidity	5 to 85% RH (no condensation)			
Storage Temperature	-55 to +85°C (no freezing)			
Storage Humidity	5 to 85% RH (no condensation)			
Degree of Protection (Screw Terminal)	SJ2S-07L: IP20 (IEC 60529)		-	
Weight	34g		4.5g	

Note: The above are same when used with a RF2 force guided relay.

## Accessories

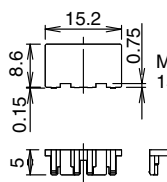
Description/Shape	Material	Part No.	Remarks
Removable Marking Plate 	Plastic (white)	<b>SJ9Z-PW</b>	 Marking area: 15.2 × 7.25 mm
Jumper	Nickel-coated brass with polypropylene coating	For 2 sockets	Terminal centers: 15.5mm Rated current: 12A Ensure that the total current to the jumper does not exceed the maximum current.
		For 5 sockets	
		For 8 sockets	
		For 10 sockets	
		<b>SJ9Z-JF2</b>	
		<b>SJ9Z-JF5</b>	
		<b>SJ9Z-JF8</b>	
		<b>SJ9Z-JF10</b>	

## Applicable Crimping Terminal

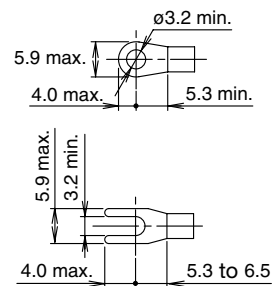

Note: Ring terminal cannot be used on SJ2S-0L.

## Replacement Parts

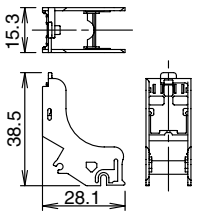
Description/Shape	Material	Part No.	Dimensions (mm)
Release Lever (with integrated marking plate) 	Plastic (gray)	<b>SJ9Z-CM</b>	 When not using marking plate

# RF2 2-pole Force Guided Relay / SJ series Socket

## Relay Dimensions

RF2S (plug-in terminal)  
Standard (without LED/diode)

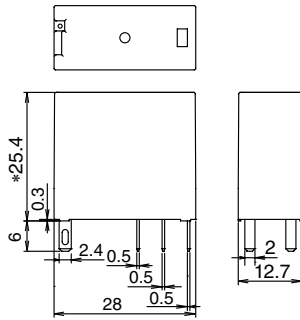

RF2V (PC board terminal)  
Standard (without LED/diode)

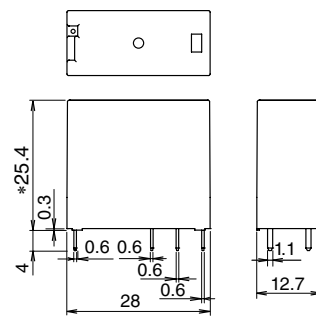

PC Board Terminal  
Mounting Hole Layout  
(Bottom View)

RF2V (SPST-NO + SPST-NC)

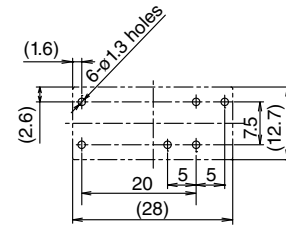

RF2V (DPDT)

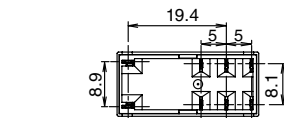
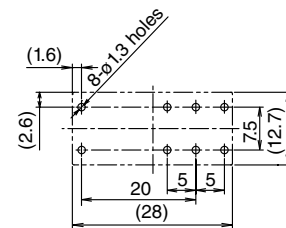

\* With LED/diode: 28.4

With LED/diode

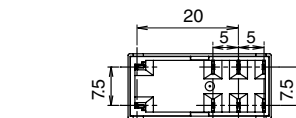
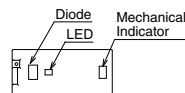

\* With LED/diode: 28.4

With LED/diode

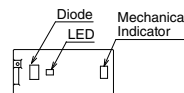

## Socket Dimensions

SJ2S-07L

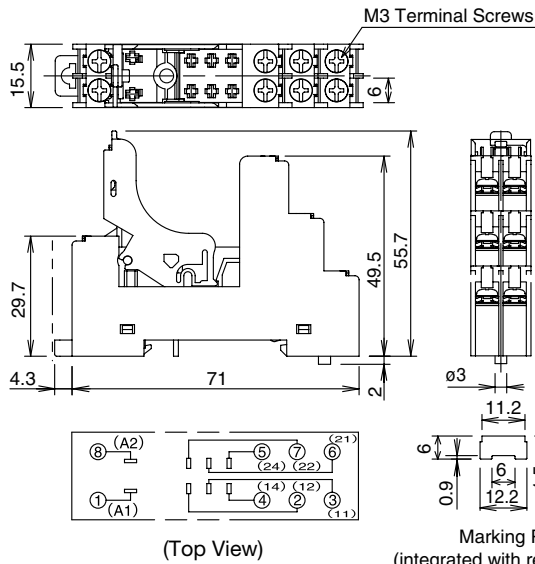

SJ2S-05B

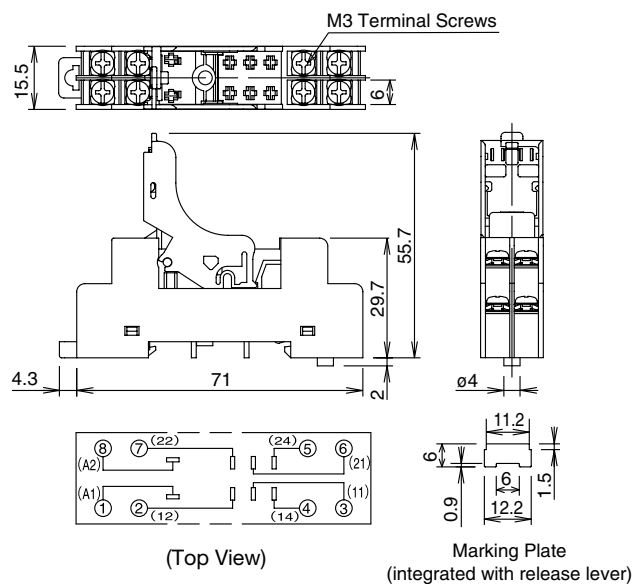

SJ2S-61

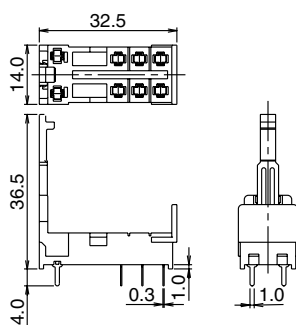

# RF2 2-pole Force Guided Relay / SJ Series Socket

## Internal Connection (Bottom View)

### RF2\*-1A1B-□

Standard

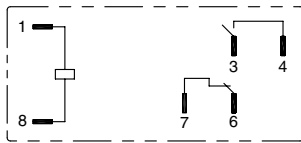

### RF2\*-1A1BLD1-□

With LED indicator + diode of reverse polarity coil

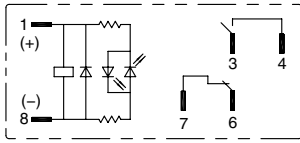

### RF2\*-1A1BLD-□

With LED indicator + diode

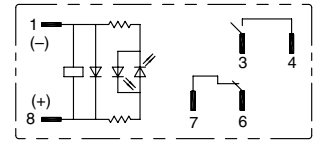

### RF2\*-2C-□

Standard

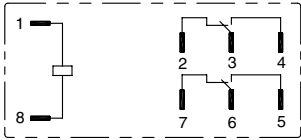

### RF2\*-2CLD1-□

With LED indicator + diode of reverse polarity coil

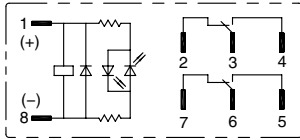

### RF2\*-2CLD-□

With LED indicator + diode

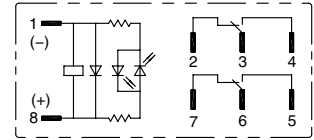

### RF2\*-1A1BL-□

With LED indicator

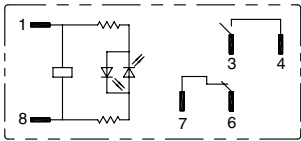

### RF2\*-1A1BD1-□

With diode of reverse polarity coil

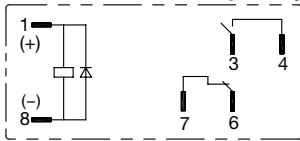

### RF2\*-1A1BD-□

With diode

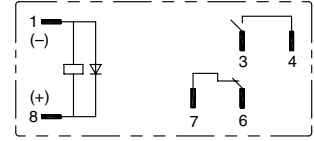

### RF2\*-2CL-□

With LED indicator

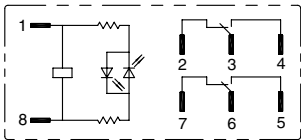

### RF2\*-2CD1-□

With diode of reverse polarity coil

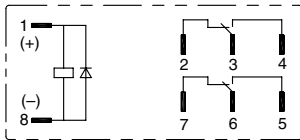

### RF2\*-2CD-□

With diode

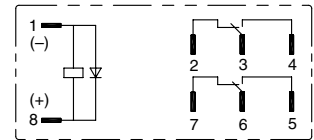

- Relays with diode have polarity. Take polarity into consideration when wiring.
- When using DPDT model as a force guided relay, use in SPST-NO + SPST-NC wiring (EN50205).

## Operating Instructions

### 1. When using DPDT model as a force guided relay

Use in SPST-NO + SPST-NC wiring according to EN50205 (2002)

#### RF2\*-2C-□

Standard

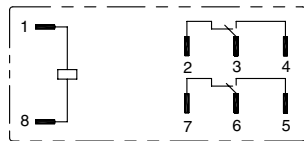

Example:

Use terminal 3-4 as NO contact and 6-7 as NC contact. Or terminal 2-3 as NC contact and terminal 5-6 as NO contact.

### 2. Driving Circuit for Relays

2-1. To make sure of correct relay operation, apply rated voltage to the relay coil. Pickup and dropout voltages may differ according to operating temperature and conditions.

2-2. Input voltage for DC coil:

A complete DC voltage is best for the coil power to make sure of stable operation. When using a power supply containing a ripple voltage, suppress the ripple factor within 5%. When power is supplied through a rectification circuit, the relay operating characteristics, such as pickup voltage and dropout voltage, depend on the ripple factor. Connect a smoothing capacitor for better operating characteristics as shown below.

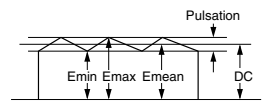
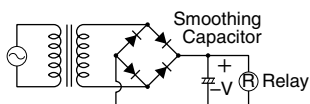

$$\text{Ripple Factor (\%)} = \frac{E_{\text{max}} - E_{\text{min}}}{E_{\text{mean}}} \times 100\%$$

$E_{\text{max}}$  = Maximum pulsating current  
 $E_{\text{min}}$  = Minimum of pulsating current  
 $E_{\text{mean}}$  = DC mean value

### 2-3. Operating the relay in sync with an AC load:

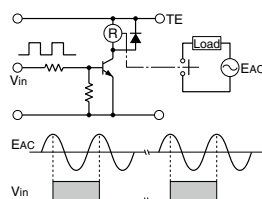

If the relay operates in sync with AC power voltage of the load, the relay life may be reduced. If this is the case, select a relay in consideration of the required reliability for the load. Or, make the relay turn on and off irrespective of the AC power phase or near the point where the AC phase crosses zero voltage.

### 2-4. Leakage current while relay is OFF

When driving an element at the same time as the relay operation, special consideration is needed for the circuit design. As shown in the incorrect circuit at right, leakage current ( $I_o$ ) flows through the relay coil while the relay is off.

Leakage current causes coil release failure or adversely affects the vibration resistance and shock resistance. Design a circuit as shown in the correct example.

Correct

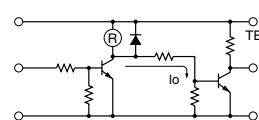

Incorrect

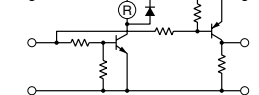

### 2-5. Surge suppression for transistor driving circuits:

When the relay coil is turned off, a high-voltage pulse is generated. Be sure to connect a diode to suppress the counter electromotive force. Then, the coil release time becomes slightly longer. To shorten the coil release time, connect a Zener diode between the collector and emitter of the controlling transistor. Select a Zener diode with a Zener voltage slightly higher than the power voltage.

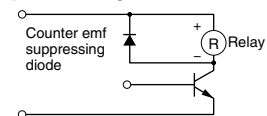

2-6. The coil terminal of the relay has polarity. Connect terminals according to the internal connection diagram. Incorrect wiring may cause malfunction.

### 3. Protection for Relay Contacts

3-1. The contact ratings show maximum values. Make sure that these values are not exceeded. When an inrush current flows through the load, the contact may become welded. If this is the case, connect a contact protection circuit, such as a current limiting resistor.