

## Force Guided Relays

# RF Series



### Enables flexible construction of safety circuits

Compact and EN compliant RF1V force guided relays.





(force guided relays)



(socket)

• See website for details on approvals and standards.

	No. of Poles	Page
	6-pole	E-186
	4-pole	E-186
	2-pole	E-192

## Force guided contact mechanism

EN50205 Type A TÜV approved

### Fast Response Time

Response time of 8 ms.  
Ensures safety by turning the load off quickly.

### High Shock Resistance

High shock resistant suitable for use in machine tools and in environments subjected to vibration and shocks. (200 m/s<sup>2</sup> minimum)

### Clear Visibility

Available with a built-in LED.

### Output expansion for safety relay modules and safety controllers

#### HR1S Safety Relay Module

Cost effective and easy method to expand mechanical contact outputs.

#### • Circuit Example

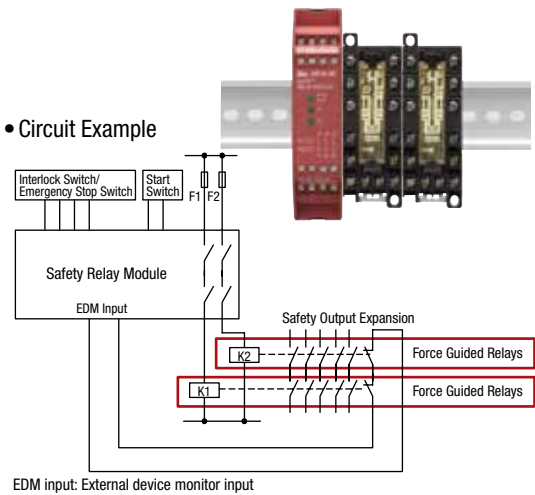

#### FS1A Safety Controller

Solid state safety outputs of safety controllers can be converted to mechanical contact outputs.

#### • Circuit Example

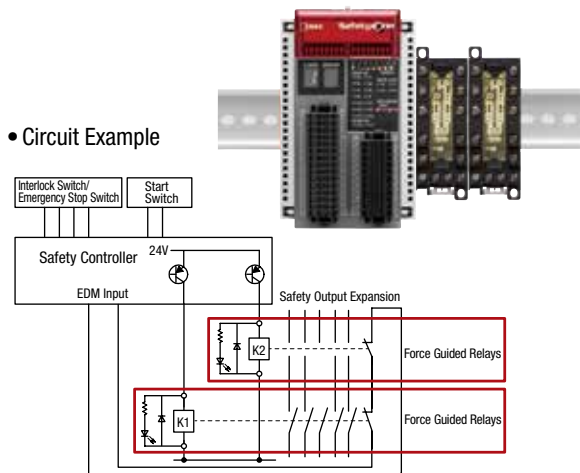

# RF1V Force-guided Relays / SF1V Relay Sockets

Compact and EN compliant RF1V force guided relays.

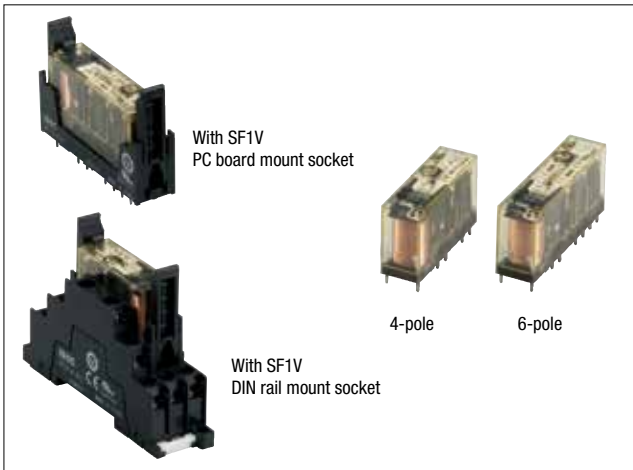

Package quantity: 10

Contact		Rated Coil Voltage	Without LED Indicator	With LED Indicator	With Counter-electromotive Force Diode With LED Indicator
			Part No.	Part No.	Part No.
4-pole	2NO-2NC	12V DC	RF1V-2A2B-D12	RF1V-2A2BL-D12	RF1V-2A2BLD1-D12
		24V DC	RF1V-2A2B-D24	RF1V-2A2BL-D24	RF1V-2A2BLD1-D24
		48V DC	RF1V-2A2B-D48	RF1V-2A2BL-D48	RF1V-2A2BLD1-D48
	3NO-1NC	12V DC	RF1V-3A1B-D12	RF1V-3A1BL-D12	RF1V-3A1BLD1-D12
		24V DC	RF1V-3A1B-D24	RF1V-3A1BL-D24	RF1V-3A1BLD1-D24
		48V DC	RF1V-3A1B-D48	RF1V-3A1BL-D48	RF1V-3A1BLD1-D48
6-pole	4NO-2NC	12V DC	RF1V-4A2B-D12	RF1V-4A2BL-D12	RF1V-4A2BLD1-D12
		24V DC	RF1V-4A2B-D24	RF1V-4A2BL-D24	RF1V-4A2BLD1-D24
		48V DC	RF1V-4A2B-D48	RF1V-4A2BL-D48	RF1V-4A2BLD1-D48
	5NO-1NC	12V DC	RF1V-5A1B-D12	RF1V-5A1BL-D12	RF1V-5A1BLD1-D12
		24V DC	RF1V-5A1B-D24	RF1V-5A1BL-D24	RF1V-5A1BLD1-D24
		48V DC	RF1V-5A1B-D48	RF1V-5A1BL-D48	RF1V-5A1BLD1-D48
	3NO-3NC	12V DC	RF1V-3A3B-D12	RF1V-3A3BL-D12	RF1V-3A3BLD1-D12
		24V DC	RF1V-3A3B-D24	RF1V-3A3BL-D24	RF1V-3A3BLD1-D24
		48V DC	RF1V-3A3B-D48	RF1V-3A3BL-D48	RF1V-3A3BLD1-D48

## Sockets

Package quantity: 10

Types	No. of Poles	Part No.
DIN Rail Mount Sockets	4	SF1V-4-07L
	6	SF1V-6-07L
PC Board Mount Sockets	4	SF1V-4-61
	6	SF1V-6-61

## Coil Ratings

Contact	Rated Coil Voltage (V)	Rated Current (mA) ±10% (at 20°C) (Note 1)	Coil Resistance (Ω) ±10% (at 20°C)	Operating Characteristics (at 20°C)			Power Consumption			
				Pickup Voltage (initial value)	Dropout Voltage (initial value)	Maximum allowable Voltage (Note 2)				
4-pole	2NO-2NC	12V DC	30.0	75% maximum	10% minimum	110%	Approx. 0.36W			
		24V DC	15.0							
		48V DC	7.5							
	3NO-1NC	12V DC	30.0							
		24V DC	15.0							
		48V DC	7.5							
6-pole	4NO-2NC	12V DC	41.7				75% maximum	10% minimum	110%	Approx. 0.50W
		24V DC	20.8							
		48V DC	10.4							
	5NO-1NC	12V DC	41.7							
		24V DC	20.8							
		48V DC	10.4							
	3NO-3NC	12V DC	41.7							
		24V DC	20.8							
		48V DC	10.4							

Note 1: For relays with LED indicator, the rated current increases by approx. 2 mA.

Note 2: Maximum allowable voltage is the maximum voltage that can be applied to relay coils.



Download catalogs and CAD from <http://asia.idec.com/downloads>

APEM

Switches & Pilot Lights

Control Boxes

Emergency Stop Switches

Enabling Switches

Safety Products

Explosion Proof

Terminal Blocks

Relays & Sockets

Circuit Protectors

Power Supplies

LED Illumination

Controllers

Operator Interfaces

Sensors

AUTO-ID

Interlock Switches

Non-contact Interlock Switches

Safety Laser Scanners

Safety Light Curtains

Safety Modules

FS1A

RF1V

RF2

HR2S

HR1S

## RF1V Force Guided Relays / SF1V Relay Sockets

## Relay Specifications

	Number of Poles	4-pole	6-pole
	Contact Configuration	2NO-2NC	3NO-1NC
	Contact Resistance (initial value) (Note 1)	100 mΩ maximum	4NO-2NC
	Contact Material	AgSnO <sub>2</sub> (Au flashed)	5NO-1NC
	Rated Load (resistive load)	6A 250V AC, 6A 30V DC	3NO-3NC
	Allowable Switching Power (resistive load)	1500 VA, 180W DC (30V DC max.), 85W DC (30V to 120V DC max.)	
	Allowable Switching Voltage	250V AC, 125V DC	
APEM	Allowable Switching Current	6A	
Switches & Pilot Lights	Minimum Applicable Load (Note 2)	5V DC, 1 mA (reference value)	
Control Boxes	Power Consumption (approx.)	0.36W	0.50W
Emergency Stop Switches	Insulation Resistance	1000 MΩ minimum (500V DC megger, same measurement positions as the dielectric strength)	
Enabling Switches	Dielectric Strength	Between contact and coil	4000V AC, 1 minute
Safety Products		Between contacts of different poles	2500V AC, 1 minute Between contacts 7-8 and 9-10
Explosion Proof			2500V AC, 1 minute Between contacts 7-8 and 11-12 Between contacts 9-10 and 13-14 Between contacts 11-12 and 13-14
Terminal Blocks	Between contacts of the same pole	4000V AC, 1 minute Between contacts 3-4 and 5-6 Between contacts 3-4 and 7-8 Between contacts 5-6 and 9-10	4000V AC, 1 minute Between contacts 3-4 and 5-6 Between contacts 3-4 and 7-8 Between contacts 5-6 and 9-10 Between contacts 7-8 and 9-10
Relays & Sockets	Operate Time (at 20°C)	20 ms maximum (at the rated coil voltage, excluding contact bounce time)	
Circuit Protectors	Response Time (at 20°C) (Note 3)	8 ms maximum (at the rated coil voltage, excluding contact bounce time, without diode) (Note 4)	
Power Supplies	Vibration Resistance	10 to 55 Hz, amplitude 0.75 mm	
LED Illumination	Shock Resistance	200 m/s <sup>2</sup> , when mounted on DIN rail mount socket: 150 m/s <sup>2</sup>	
Controllers	Electrical Life	250V AC 6A resistive load: 100,000 operations minimum (operating frequency 1200 per hour)	
Operator Interfaces		30V DC 6A resistive load: 100,000 operations minimum (operating frequency 1200 per hour)	
Sensors	Mechanical Life	250V AC 1A resistive load: 500,000 operations minimum (operating frequency 1800 per hour)	
AUTO-ID		30V DC 1A resistive load: 500,000 operations minimum (operating frequency 1800 per hour)	
Interlock Switches	Operating Temperature (Note 5)	[AC 15] 240V AC 2A inductive load: 100,000 operations minimum (operating frequency 1200 per hour, cos φ = 0.3)	
Non-contact Interlock Switches		[DC 13] 24V DC 1A inductive load: 100,000 operations minimum (operating frequency 1200 per hour, L/R = 48 ms)	
Safety Laser Scanners	Operating Humidity	5 to 85%RH (no condensation)	
Safety Light Curtains	Storage Temperature	-40 to +85°C (no freezing)	
Safety Modules	Storage Humidity	5 to 85%RH (no condensation)	
	Operating Frequency (rated load)	1200 operations per hour	
	Weight (approx.)	20g	23g

Note 1: Measured using 6V DC, 1A voltage drop method.

Note 2: Failure rate level P (reference value)

Note 3: Response time is the time until NO contact opens, after the coil voltage is turned off.

Note 4: With diode: 12ms maximum (at the rated coil voltage, excluding contact bounce time)

Note 5: See the table below for the current and operating temperature

## Socket Specifications

Model	SF1V-4-07L	SF1V-6-07L	SF1V-4-61	SF1V-6-61
Rated Current	6A			
Rated Voltage	250V AC/DC			
Insulation Resistance	1000 MΩ minimum (500V DC megger, between terminals)			
Applicable Wire	0.7 to 1.65 mm <sup>2</sup> (18 AWG to 14 AWG)		—	
Recommended Screw Tightening Torque	0.5 to 0.8 N·m		—	
Screw Terminal Style	M3 slotted Phillips self-tapping screw		—	
Terminal Strength	Wire tensile strength: 50N min.		—	
Dielectric Strength	2500V AC, 1 minute (Between live and dead metal parts, between live parts of different poles)			
Vibration Resistance	Damage limits: 10 to 55 Hz, amplitude 0.75 mm Resonance: 10 to 55 Hz, amplitude 0.75 mm			
Shock Resistance	1000 m/s <sup>2</sup>			
Operating Temperature (Note)	-40 to +85°C (no freezing)			
Operating Humidity	5 to 85% RH (no condensation)			
Storage Temperature	-40 to +85°C (no freezing)			
Storage Humidity	5 to 85% RH (no condensation)			
Degree of Protection	IP20 (finger-safe screw terminals)		—	
Weight (approx.)	40g	55g	9g	10g

Note: See the table at right for the current and operating temperature.

## Operating Temperature (relay, socket)

	Single mounting	Collective mounting	
Operating Temperature	-40°C to +85°C	4-pole	-40°C to +70°C
		6-pole	-40°C to +65°C
Contact Current	6A	6A	
Remarks	When the ambient temperature is over 70°C, lower the contact current at 0.1A/°C. 5NO1NC: Up to 70°C: Keep the total current of NO side to 24A maximum. Over 70°C: Lower the contact current at 0.1A/°C.	4-pole	When the ambient temperature is over 60°C, lower the contact current at 0.1A/°C.
		6-pole	When the ambient temperature is over 50°C, lower the contact current at 0.1A/°C. 5NO1NC: Up to 50°C: Keep the total current of NO side to 24A maximum. Over 50°C: Lower the contact current at 0.1A/°C.

## Applicable Crimping Terminal

All dimensions in mm.

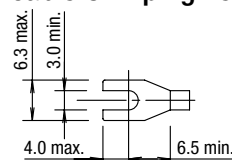

Note: Ring tongue terminals cannot be used.

Accessories

Item	Shape	Specifications	Part No.	Ordering Part No.	Package Quantity	Remarks
DIN Rail		Aluminum Weight: Approx. 200g	BAA1000	BAA1000PN10	10	Length: 1m Width: 35mm
		Steel Weight: Approx. 320g	BAP1000	BAP1000PN10	10	
End Clip		Metal (zinc plated steel) Weight: Approx. 15g	BNL5	BNL5PN10	10	—
			BNL6	BNL6PN10	10	

Characteristics

Maximum Switching Capacity

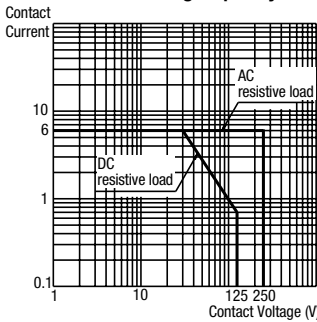

Electrical Life Curve

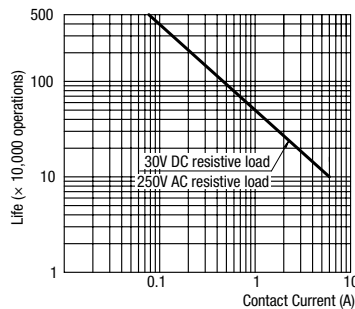

Notes on Contact Gaps except Welded Contacts

Example: RF1V-2A2B-D24

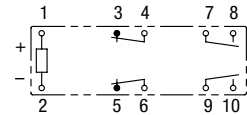

- If the NO contact (7-8 or 9-10) welds, the NC contact (3-4 or 5-6) remains open even when the relay coil is de-energized, maintaining a gap of 0.5 mm minimum. The remaining unwelded NO contact (9-10 or 7-8) is either open or closed.
- If the NC contact (3-4 or 5-6) welds, the NO contact (7-8 or 9-10) remains open even when the relay coil is energized, maintaining a gap of 0.5 mm minimum. The remaining unwelded NC contact (5-6 or 3-4) is either open or closed.

Dimensions

(All dimensions in mm.)

RF1V Relays

RF1V (4-pole)

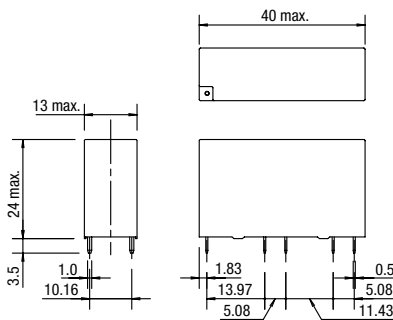

RF1V (6-pole)

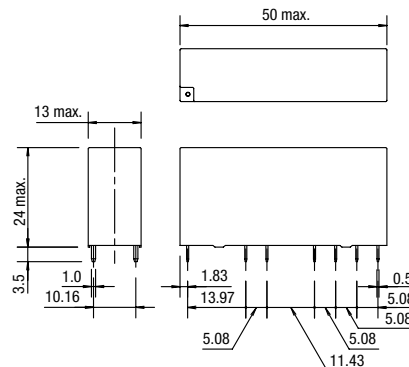

PC Board Terminal Model

Mounting Hole Layout (Bottom View)

RF1V (4-pole)

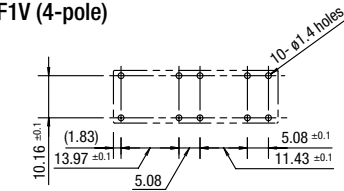

RF1V (6-pole)

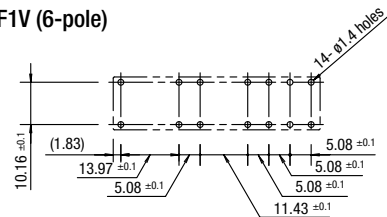

Internal Connection (Bottom View)

RF1V (4-pole)

Without LED Indicator

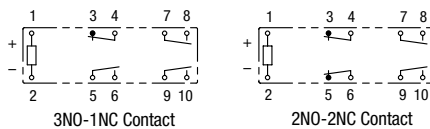

RF1V (6-pole)

Without LED Indicator

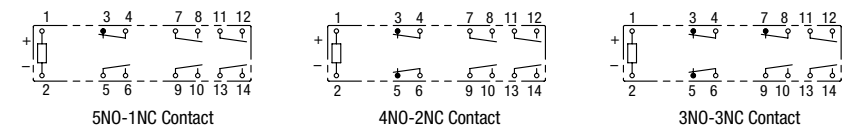

With LED Indicator

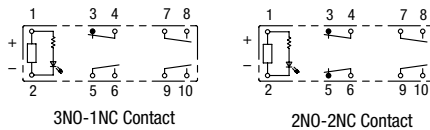

With LED Indicator

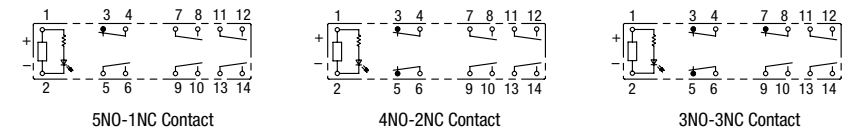

With Counter-electromotive Force Diode

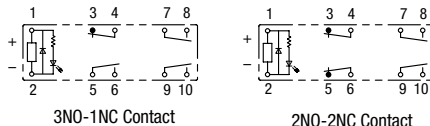

With Counter-electromotive Force Diode

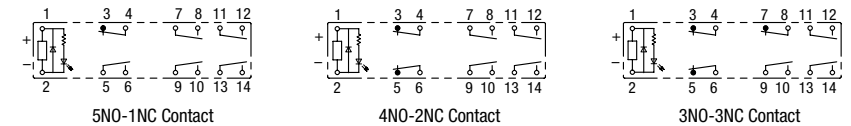

Dimensions

(All dimensions in mm.)

SF1V PC Board Mount Sockets

SF1V (4-pole)

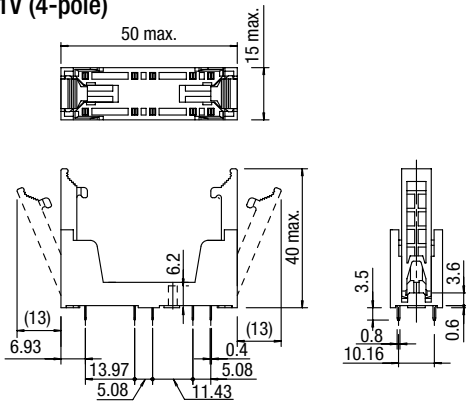

SF1V (6-pole)

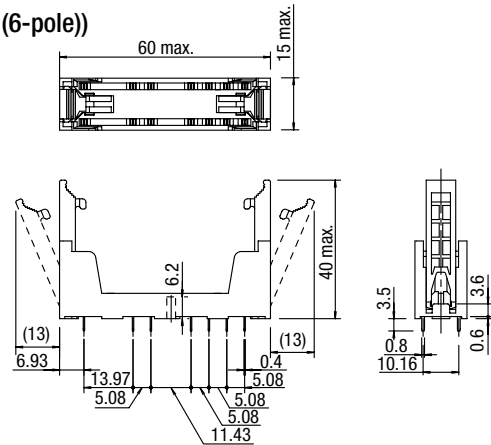

PC Board Mounting Hole Layout / Terminal Arrangement (Bottom View)

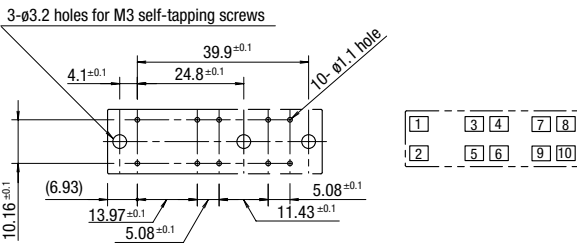

PC Board Mounting Hole Layout / Terminal Arrangement (Bottom View)

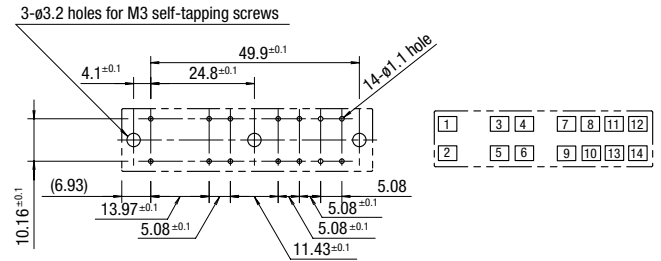

SF1V DIN Rail Mount Socket Dimensions

SF1V (4-pole)

(Internal Connection)

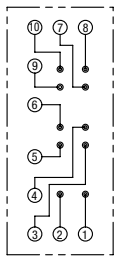

(Top View)

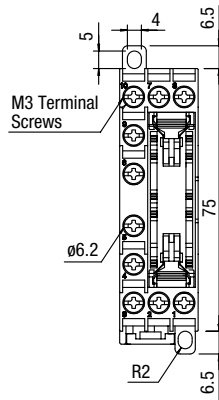

SF1V (6-pole)

(Internal Connection)

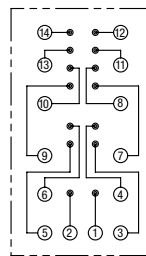

(Top View)

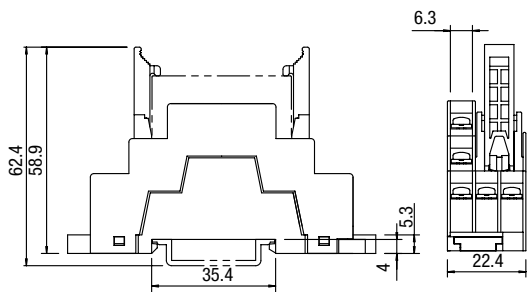
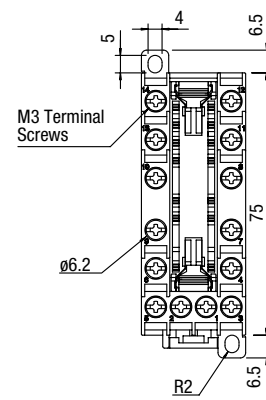

(Panel Mounting Hole Layout)

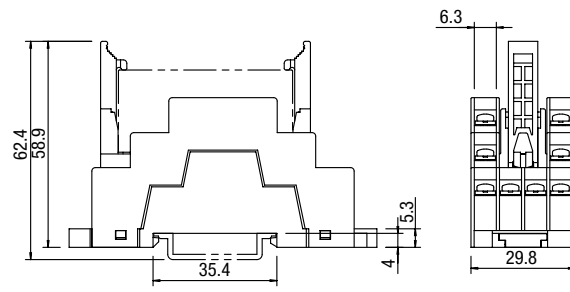
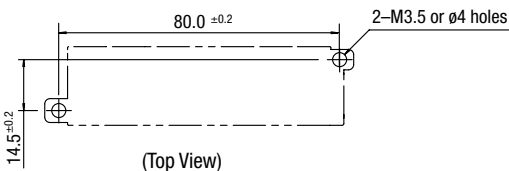

(Panel Mounting Hole Layout)

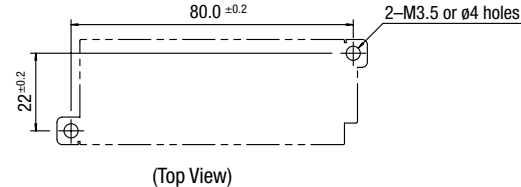

Operating Instructions

1. Driving Circuit for Relays

- To make sure of correct relay operation, apply rated voltage to the relay coil. Pickup and dropout voltages may differ according to operating temperature and conditions.
- Input voltage for DC coil:  
A complete DC voltage is best for the coil power to make sure of stable operation. When using a power supply containing a ripple voltage, suppress the ripple factor within 5%. When power is supplied through a rectifications circuit, relay operating characteristics, such as pickup voltage and dropout voltage, depend on the ripple factor. Connect a smoothing capacitor for better operating characteristics as shown below.

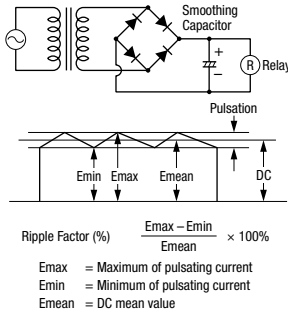

3. Operating the relay in sync with an AC load:

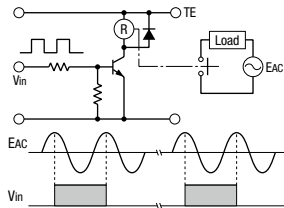

If the relay operates in sync with AC power voltage of the load, the relay life may be reduced. If this is the case, select a relay in consideration of the required reliability for the load. Or, make the relay turn on and off irrespective of the AC power phase or near the point where the AC phase crosses zero voltage.

4. Leakage current while relay is off:

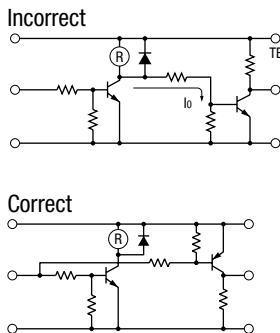

When driving an element at the same time as the relay operation, special consideration is needed for the circuit design. As shown in the incorrect circuit below, leakage current ( $I_o$ ) flows through the relay coil while the relay is off. Leakage current causes coil release failure or adversely affects the vibration resistance and shock resistance. Design a circuit as shown in the correct example.

- Surge suppression for transistor driving circuits: When the relay coil is turned off, a high-voltage pulse is generated. Be sure to connect a diode to suppress the counter electromotive force, or use RF1V with counter-electromotive force diode. Then, the coil release time becomes slightly longer. To shorten the coil release time, connect a Zener diode between the collector and emitter of the controlling transistor. Select a Zener diode with a Zener voltage slightly higher than the power voltage.

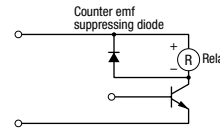

- The coil terminal of the relay has polarity. Connect terminals according to the internal connection diagram. Incorrect wiring may cause malfunction.

2. Protection for Relay Contacts

- The contact ratings show maximum values. Make sure that these values are not exceeded even momentarily. When an inrush current flows through the load, the contact may become welded. If this is the case, connect a contact protection circuit, such as a current limiting resistor.
- Contact protection circuit:  
When switching an inductive load, arcing causes carbides to form on the contacts, resulting in an increased contact resistance. In consideration of contact reliability, contact life, and noise suppression, use of a surge absorbing circuit is recommended. Note that the release time of the load becomes slightly longer. Check the operation using an actual load. Incorrect use of a contact protection circuit will adversely affect switching characteristics. Four typical examples of contact protection circuits are shown in the following table:

RC		This protection circuit can be used when the load impedance is smaller than the RC impedance in an AC load power circuit. R: Resistor of approximately the same resistance value as the load C: 0.1 to 1 $\mu$ F
		This protection circuit can be used for both AC and DC load power circuits. R: Resistor of approximately the same resistance value as the load C: 0.1 to 1 $\mu$ F
Diode		This protection circuit can be used for DC load power circuits. Use a diode with the following ratings. Reverse withstand voltage: Power voltage of the load circuit $\times$ 10 Forward current: More than the load current
Varistor		This protection circuit can be used for both AC and DC load power circuits. For a best result, when using on a power voltage of 24 to 48V AC/DC, connect a varistor across the load. When using on a power voltage of 100 to 240V AC/DC, connect a varistor across the contacts.

APEM

Switches & Pilot Lights

Control Boxes

Emergency Stop Switches

Enabling Switches

Safety Products

Explosion Proof

Terminal Blocks

Relays & Sockets

Circuit Protectors

Power Supplies

LED Illumination

Controllers

Operator Interfaces

Sensors

AUTO-ID

Interlock Switches

Non-contact Interlock Switches

Safety Laser Scanners

Safety Light Curtains

Safety Modules

FS1A

RF1V

RF2

HR2S

HR1S



## Operating Instructions

### 3. Do not use a contact protection circuit as shown below:

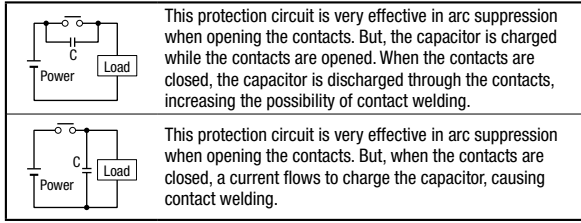

Generally, switching a DC inductive load is more difficult than switching a DC resistive load. Using an appropriate arc suppressor will improve the switching characteristics of a DC inductive load.

### 3. Usage, transport, and storage conditions

- Temperature, humidity, atmospheric pressure during usage, transport, and storage.
  - Temperature:  $-40^{\circ}\text{C}$  to  $+85^{\circ}\text{C}$  (no freezing)  
See **E-187** for the current and operating temperature.
  - Humidity: 5 to 85%RH (no condensation)  
The humidity range varies with temperature. Use within the range indicated in the chart below.
  - Atmospheric pressure: 86 to 106 kPa  
Operating temperature and humidity range

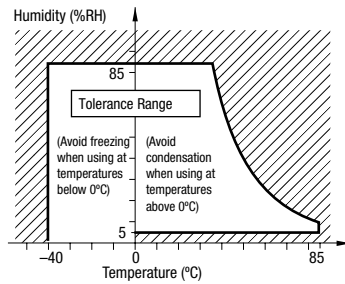

- Condensation  
Condensation occurs when there is a sudden change in temperature under high temperature and high humidity conditions. The relay insulation may deteriorate due to condensation.
- Freezing  
Condensation or other moisture may freeze on the relay when the temperatures is lower than  $0^{\circ}\text{C}$ . This causes problems such as sticking of movable parts or delay in operation.
- Low temperature, low humidity environments  
Plastic parts may become brittle when used in low temperature and low humidity environments.

### 4. Panel Mounting

When mounting DIN rail mount sockets on a panel, take the following into consideration.

- Use M3.5 screws, spring washers, and hex nuts.
- For mounting hole layout, see dimensions on **E-189**.
- Keep the tightening torque within 0.49 to 0.68 N·m. Excessive tightening may cause damage to the socket.

### 5. Others

#### 1. General notice

- To maintain the initial characteristics, do not drop or shock the relay.
- The relay cover cannot be removed from the base during normal operation. To maintain the initial characteristics, do not remove the relay cover.
- Use the relay in environments free from condensation, dust, sulfur dioxide ( $\text{SO}_2$ ), and hydrogen sulfide ( $\text{H}_2\text{S}$ ).
- The RF1V relay cannot be washed as it is not a sealed type. Also make sure that flux does not leak to the PC board and enter the relay.

#### 2. Connecting outputs to electronic circuits:

When the output is connected to a load which responds very quickly, such as an electronic circuit, contact bouncing causes incorrect operation of the load. Take the following measures into consideration.

- Connect an integration circuit.
  - Suppress the pulse voltage due to bouncing within the noise margin of the load.
- Do not use relays in the vicinity of strong magnetic field, as this may affect relay operation.
  - UL and CSA ratings may differ from product rated values determined by IDEC.

### 6. Notes on PC Board Mounting

- When mounting 2 or more relays on a PC board, keep a minimum spacing of 10 mm in each direction. If used without spacing of 10 mm, rated current and operating temperature differs. Consult IDEC.
- Manual soldering: Solder the terminals at  $400^{\circ}\text{C}$  within 3 sec.
- Auto-soldering: Preliminary heating at  $120^{\circ}\text{C}$  within 120 sec. Solder at  $260^{\circ}\text{C} \pm 5^{\circ}\text{C}$  within 6 sec.
- Because the terminal part is filled with epoxy resin, do not excessively solder or bend the terminal. Otherwise, air tightness will degrade.
- Avoid the soldering iron from touching the relay cover or the epoxy filled terminal part.
- Use a non-corrosive resin flux.

# RF2 2-pole Force Guided Relay / SJ Series Socket

For simple and easy safety measure. Reduce cost and installation space.

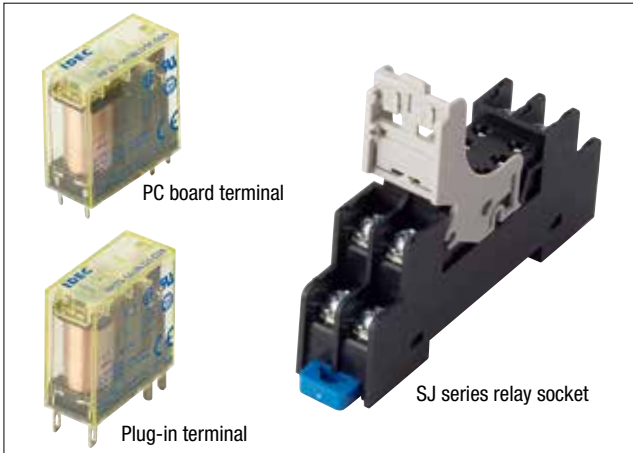

## Force Guided Relays

Contact Configuration	Terminal Style	LED Indicator	w/diode of reverse polarity coil	Degree of Protection		Rated Coil Voltage	Part No.	
				Flux-tight (RTII)	Sealed (RTIII)			
2-pole	SPST-NO + SPST-NC	Plug-in	With	√	√	—	12V DC	RF2S-1A1BLD1-D12
			Without	—	√	—	24V DC	RF2S-1A1B-D24
			With	√	√	—		RF2S-1A1BD1-D24
			Without	—	√	—	RF2S-1A1BLD1-D24	
			With	√	—	√	RF2S-1A1BLD1K-D24	
			Without	—	√	—	48V DC	RF2S-1A1B-D48
	DPDT (*1)	Plug-in	With	√	√	—	24V DC	RF2S-1A1BD1-D48
			Without	—	√	—	RF2S-1A1BLD1K-D48	
			With	√	√	—	24V DC	RF2S-2C-D24
			Without	—	√	—	RF2S-2CD1-D24	
	SPST-NO + SPST-NC	PC Board	Without	—	√	—	12V DC	RF2V-1A1B-D12
				—	√	—	24V DC	RF2V-1A1B-D24
				—	—	√	RF2V-1A1BK-D24	
				√	√	—	RF2V-1A1BD1-D24	
With			√	—	√	24V DC	RF2V-1A1BD1K-D24	
			√	—	√	RF2V-1A1BLD1K-D24		
			—	√	—	48V DC	RF2V-1A1B-D48	
			Without	—	√	—	24V DC	RF2V-2C-D24

\*1) When using DPDT model as a force guided relay, use in SPST-NO+SPST-NC wiring (EN50205).

• Other part numbers are available. See below (contact IDEC for details).

## Part No. Development

RF	2	S	—	1A1B	LD1	K	—	D24				
Series	No. of Poles		Terminal Style		Contact Configuration		Option		Degree of Protection		Rated Coil Voltage	
	2	2-pole	S	Plug-in	1A1B	SPST-NO + SPST-NC		Blank	Standard		Blank	RTII
			V	PC Board		2C		DPDT	L	With LED indicator		
								D	With diode (Note 1)			
								D1	With diode of reverse polarity coil (Note 2)			
								LD	With LED indicator & diode (Note 1)			
								LD1	With LED indicator & diode of reverse polarity coil (Note 2)			
											D12	12V DC
											D24	24V DC
											D48	48V DC

Note 1: With diode: terminal 1 -, terminal 8 +

Note 2: With diode of reverse polarity coil: terminal 1 +, terminal 8 -

Note 3: Use this chart for interpreting part numbers. Not all possible variations can be realized.

APEM

Switches & Pilot Lights

Control Boxes

Emergency Stop Switches

Enabling Switches

Safety Products

Explosion Proof

Terminal Blocks

Relays & Sockets

Circuit Protectors

Power Supplies

LED Illumination

Controllers

Operator Interfaces

Sensors

AUTO-ID

Interlock Switches

Non-contact Interlock Switches

Safety Laser Scanners

Safety Light Curtains

Safety Modules

FS1A

RF1V

RF2

HR2S

HR1S





## RF2 2-pole Force Guided Relay / SJ Series Socket

## Standard Ratings

Voltage	UL Rating Resistive		CSA Rating Resistive	
	NO	NC	NO	NC
277V AC	6A	3A	6A	3A
30V DC	6A	3A	6A	3A

Voltage	TÜV Rating Resistive	
	NO	NC
240VAC	6A	3A
24V DC	6A	3A

## Ratings

## Coil ratings

Rated Voltage (V)	Rated Current (mA) ±15% (at 20°C)		Coil Resistance ±10% (at 20°C)	Operating Characteristics (against rated values at 20°C)			Power Consumption
	Without LED	With LED		Minimum Pickup Voltage	Dropout Voltage	Maximum Allowable Voltage (Note)	
12V DC	58	63	205	75% maximum	10% minimum	110%	Approx. 0.7W
24V DC	29	33	820				
48V DC	14.6	18	3300				

Note: Maximum allowable voltage is the maximum voltage that can be applied to relay coils.

## Specifications

Model	RF2S (Plug-in Terminal)		RF2V (PC board terminal)	
No. of Poles	2-pole			
Contact Configuration	SPST-NO + SPST-NC, DPDT			
Disconnecting Means	Micro disconnection			
Contact Resistance (Note 1)	100mΩ maximum			
Contact Material	AgNi+Au-Clad			
Degree of Protection	RTII (flux-tight), RTIII (sealed)			
Rated Load (resistive load)	NO contact: 240V AC, 6A/24V DC, 6A NC contact: 240V AC, 3A/24V DC, 3A			
Contact	Maximum Allowable Power (resistive load)		NO contact: 1440VA/144W, NC contact: 720VA/72W	
	Maximum Allowable Voltage		250V AC, 125V DC	
	Maximum Allowable Current		6A	
Minimum Applicable Load (Note 2)	1V DC, 1mA			
Power Consumption	Approx. 0.7W			
Rated Insulation Voltage	250V			
Insulation Resistance	1000MΩ minimum (500V megger)			
Impulse Withstand Voltage	6000V			
Pollution Degree	2			
Dielectric Strength	Between contact and coil		5000V AC, 1 minute	
	Between contacts of the same pole		4000V AC, 1 minute	
	Between contacts of the different poles		1500V AC, 1 minute	
Operating Time	15ms max. (at the rated coil voltage, excluding contact bounce time)			
Response Time (Note 3)	5ms max. (at the rated coil voltage, without diode)			
	20ms max. (at the rated coil voltage, with diode)			
Release Time	10ms max. (at the rated coil voltage, excluding contact bounce time, without diode)			
	25ms max. (at the rated coil voltage, excluding contact bounce time, with diode)			
Vibration Resistance	Operating Extremes		NO contact: 10 to 55Hz, amplitude 0.75mm NC contact: 10 to 55Hz, amplitude 0.2mm	
	Damage Limits		10 to 55Hz, amplitude 0.75mm	
Shock Resistance	Operating Extremes		NO contact: 100m/s <sup>2</sup> , NC contact: 50m/s <sup>2</sup>	
	Damage Limits		1000m/s <sup>2</sup>	
Electrical Life	NO contact: 100,000 operations minimum (operating frequency 1,800 per hour) at 240V 6A resistive load or 2A inductive load (power factor 0.4) 100,000 operations minimum (operating frequency 1,800 per hour) at 24V 6A resistive load or 1A inductive load (time constant 48ms) NC contact: 100,000 operations minimum (operating frequency 1,800 per hour) at 240V AC, 3A resistive load or 2A inductive load (power factor 0.4) 100,000 operations minimum (operating frequency 1,800 per hour) at 24V DC, 3A resistive load or 1A inductive load (time constant 48ms)			
Mechanical Life	10 million operations minimum (operating frequency 18,000 operations per hour)			
Operating Temperature	Single mounting: -40 to +70°C (no freezing) Collective mounting: -40 to +55°C (no freezing)		-40 to +70°C (no freezing)	
Operating Humidity	5 to 85%RH (no condensation)			
Storage Temperature	-40 to +85°C (no freezing)			
Weight (approx.)	18g (without LED/diode), 20g (with LED/with diode/with LED & diode)			

• Above values are initial values.

Note 1: Measured using 5V DC, 1A voltage drop method.

Note 2: Failure rate level P, reference value

Note 3: Response time is the time until NO contact opens, after the coil voltage is turned off.

SJ Series Relay Socket



• See website for details on approvals and standards.

Sockets

DIN-rail Socket

Package Quantity: 1

Terminal Style	No. of Poles	Terminal No. Marking Color	Part No.
Standard Screw Terminal	2	White	SJ2S-05BW
Fingersafe Screw Terminal			SJ2S-07LW

- Release lever is supplied with the socket.
- Terminal number marking in white also available.

PC Board Socket

Package Quantity: 1

No. of Poles	Part No.	Ordering No.	Package Quantity
2	SJ2S-61	SJ2S-61PN10	10
	SJ2S-61	SJ2S-05PN50	50

- Release lever is supplied with the socket.

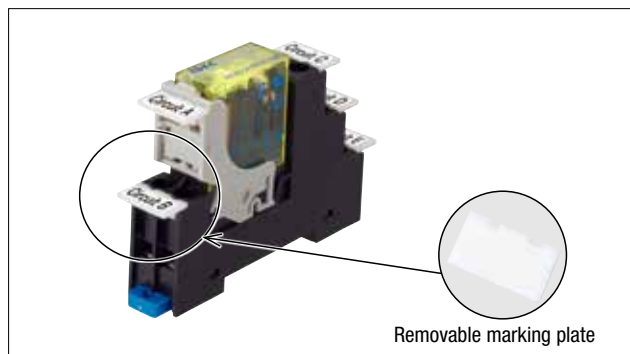

Note: Sockets can be used on RF2S (Plug-in terminal) only.

Accessories

Description/Shape	Material	Part No.	Ordering No.	Package Quantity	Remarks
Removable Marking Plate	Plastic (white)	SJ9Z-PW	SJ9Z-PWPN10	10	<p>Marking area: 15.2 × 7.25 mm</p>
Jumper	For 2 sockets	SJ9Z-JF2	SJ9Z-JF2PN10		
	For 5 sockets	SJ9Z-JF5	SJ9Z-JF5PN10		
	For 8 sockets	SJ9Z-JF8	SJ9Z-JF8PN10		
	For 10 sockets	SJ9Z-JF10	SJ9Z-JF10PN10		
					Terminal centers: 15.5mm Rated current: 12A Ensure that the total current to the jumper does not exceed the maximum current.

Replacement Parts

Description/Shape	Material	Part No.	Ordering No.	Package Quantity	Dimensions (mm)
Release Lever (with integrated marking plate)	Plastic (gray)	SJ9Z-CM	SJ9Z-CMPN05	5	<p>When not using marking plate</p>

Socket Specifications

Model	SJ2S-05B/-07L (DIN Rail Socket)	SJ2S-61 (PC Board Socket)
Rated Current	8A	
Rated Insulation Voltage	250V AC/DC	
Applicable Wire	2mm <sup>2</sup>	—
Applicable Crimping Terminal	See the dimensions shown at right	—
Recommended Tightening Torque	0.6 to 1.0 N·m	
Screw Terminal Style	M3 slotted Phillips screw (self-lifting)	
Terminal Strength	Wire tensile strength: 50N minimum	
Dielectric Strength (Note)	Between contact and coil	4000V AC, 1 minute
	Between contacts of the same pole	1000V AC, 1 minute
	Between contacts of the different pole	3000V AC, 1 minute
Vibration Resistance	Damage limits	90m/s <sup>2</sup>
	Resonance	Frequency 10 to 55Hz, amplitude 0.75mm
Shock Resistance (damage limits)	1000m/s <sup>2</sup>	
Operating Temperature	-40 to +70°C (no freezing)	
Operating Humidity	5 to 85% RH (no condensation)	
Storage Temperature	-55 to +85°C (no freezing)	
Degree of Protection (Screw Terminal)	SJ2S-07L: IP20 (IEC 60529)	—
Weight	34g	4.5g

Note: The above are same when used with a RF2 force guided relay.

Applicable Crimping Terminal

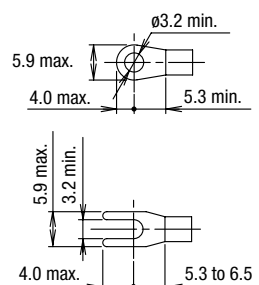

Note: Ring terminal cannot be used on SJ2S-0L.

- APEM
- Switches & Pilot Lights
- Control Boxes
- Emergency Stop Switches
- Enabling Switches
- Safety Products
- Explosion Proof
- Terminal Blocks
- Relays & Sockets
- Circuit Protectors
- Power Supplies
- LED Illumination
- Controllers
- Operator Interfaces
- Sensors
- AUTO-ID

- Interlock Switches
- Non-contact Interlock Switches
- Safety Laser Scanners
- Safety Light Curtains
- Safety Modules

- FS1A
- RF1V
- RF2
- HR2S
- HR1S

# RF2 2-pole Force Guided Relay / SJ Series Socket

## Dimensions

(All dimensions in mm.)

### Relay Dimensions

**RF2S (plug-in terminal)  
Standard (without LED/diode)**

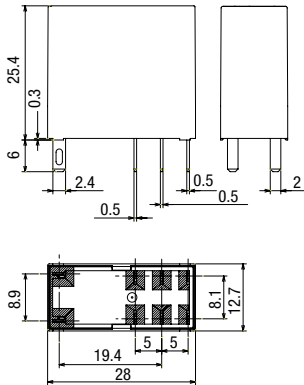

**RF2V (PC board terminal)  
Standard (without LED/diode)**

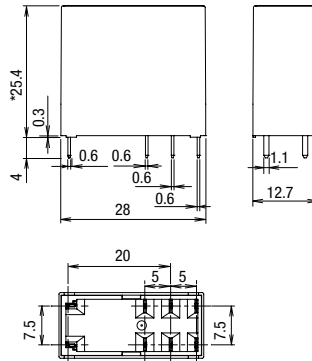

**PC Board Terminal Mounting Hole  
Layout  
(Bottom View)**

**RF2V (SPST-NO + SPST-NC)**

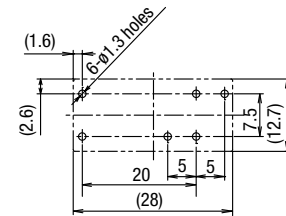

**RF2V (DPDT)**

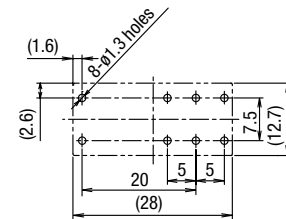

\* With LED/diode: 28.4

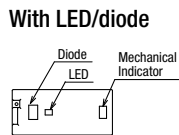

\* With LED/diode: 28.4

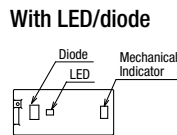

### Socket Dimensions

**SJ2S-07L**

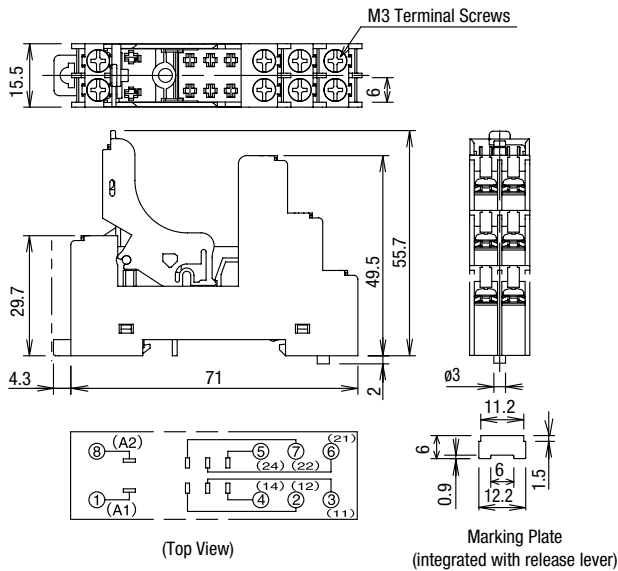

**SJ2S-05B**

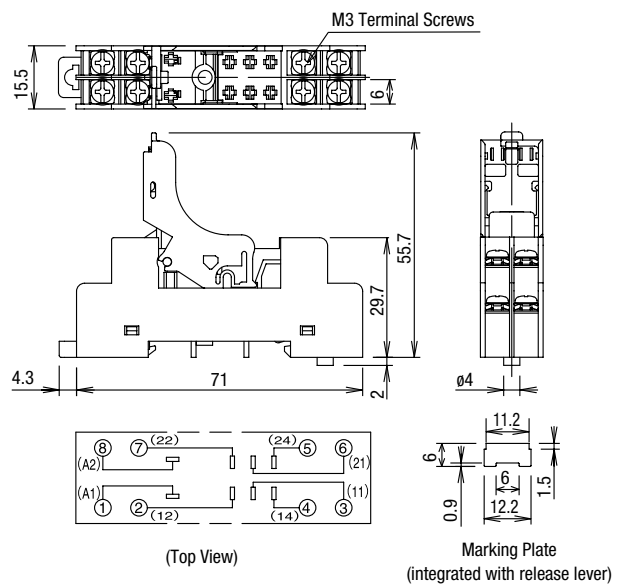

**SJ2S-61**

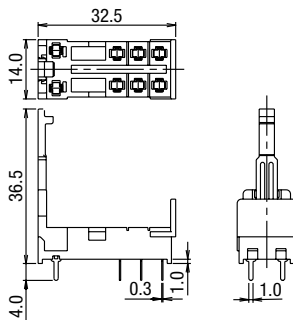

Dimensions

(All dimensions in mm.)

Internal Connection (Bottom View)

RF2\*-1A1B-□  
Standard

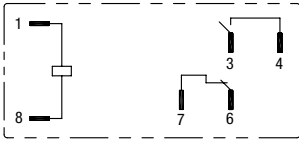

RF2\*-1A1BLD1-□  
With LED indicator + diode of reverse polarity coil

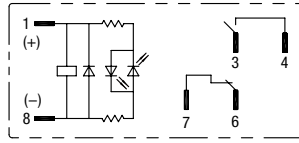

RF2\*-1A1BLD-□  
With LED indicator + diode

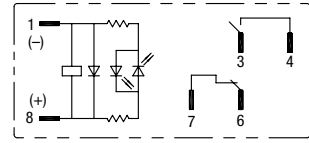

RF2\*-2C-□  
Standard

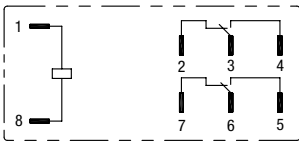

RF2\*-2CLD1-□  
With LED indicator + diode of reverse polarity coil

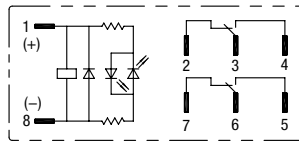

RF2\*-2CLD-□  
With LED indicator + diode

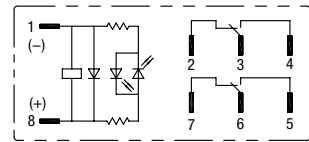

RF2\*-1A1BL-□  
With LED indicator

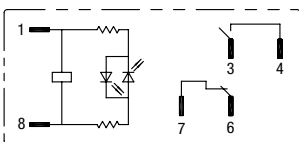

RF2\*-1A1BD1-□  
With diode of reverse polarity coil

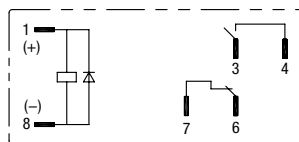

RF2\*-1A1BD-□  
With diode

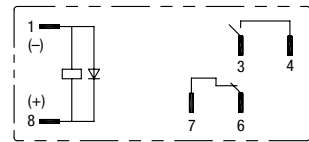

RF2\*-2CL-□  
With LED indicator

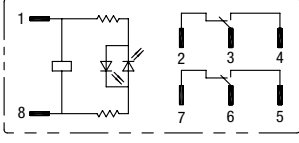

RF2\*-2CD1-□  
With diode of reverse polarity coil

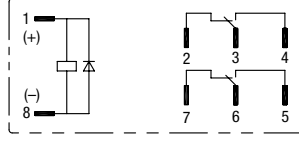

RF2\*-2CD-□  
With diode

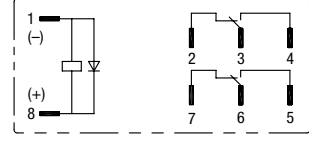

- Relays with diode have polarity. Take polarity into consideration when wiring.
- When using DPDT model as a force guided relay, use in SPST-NO + SPST-NC wiring (EN50205).

APEM

Switches & Pilot Lights

Control Boxes

Emergency Stop Switches

Enabling Switches

Safety Products

Explosion Proof

Terminal Blocks

Relays & Sockets

Circuit Protectors

Power Supplies

LED Illumination

Controllers

Operator Interfaces

Sensors

AUTO-ID

Interlock Switches

Non-contact Interlock Switches

Safety Laser Scanners

Safety Light Curtains

Safety Modules

FS1A

RF1V

RF2

HR2S

HR1S



## Operating Instructions

### 1. When using DPDT model as a force guided relay

Use in SPST-NO + SPST-NC wiring according to EN50205 (2002)

RF2\*-2C-□

Standard

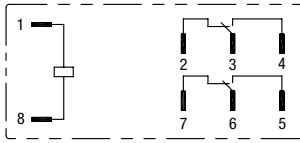

Example:

Use terminal 3-4 as NO contact and 6-7 as NC contact. Or terminal 2-3 as NC contact and terminal 5-6 as NO contact.

### 2. Driving Circuit for Relays

2-1. To make sure of correct relay operation, apply rated voltage to the relay coil. Pickup and dropout voltages may differ according to operating temperature and conditions.

2-2. Input voltage for DC coil:

A complete DC voltage is best for the coil power to make sure of stable operation. When using a power supply containing a ripple voltage, suppress the ripple factor within 5%. When power is supplied through a rectification circuit, the relay operating characteristics, such as pickup voltage and dropout voltage, depend on the ripple factor. Connect a smoothing capacitor for better operating characteristics as shown below.

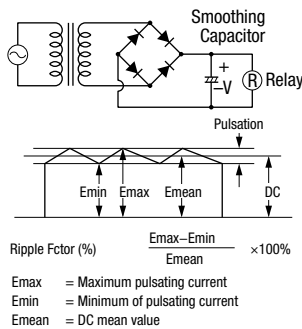

### 2-3. Operating the relay in sync with an AC load:

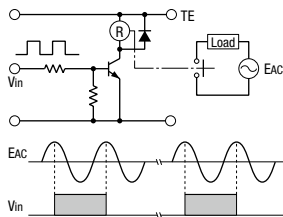

If the relay operates in sync with AC power voltage of the load, the relay life may be reduced. If this is the case, select a relay in consideration of the required reliability for the load. Or, make the relay turn on and off irrespective of the AC power phase or near the point where the AC phase crosses zero voltage.

### 2-4. Leakage current while relay is OFF

When driving an element at the same time as the relay operation, special consideration is needed for the circuit design. As shown in the incorrect circuit at right, leakage current ( $I_0$ ) flows through the relay coil while the relay is off.

Leakage current causes coil release failure or adversely affects the vibration resistance and shock resistance. Design a circuit as shown in the correct example.

Correct

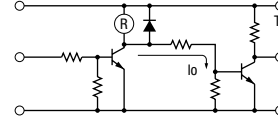

Incorrect

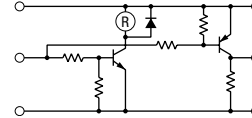

### 2-5. Surge suppression for transistor driving circuits:

When the relay coil is turned off, a high-voltage pulse is generated. Be sure to connect a diode to suppress the counter electromotive force. Then, the coil release time becomes slightly longer. To shorten the coil release time, connect a Zener diode between the collector and emitter of the controlling transistor. Select a Zener diode with a Zener voltage slightly higher than the power voltage.

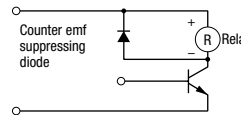

### 2-6. The coil terminal of the relay has polarity.

Connect terminals according to the internal connection diagram. Incorrect wiring may cause malfunction.