

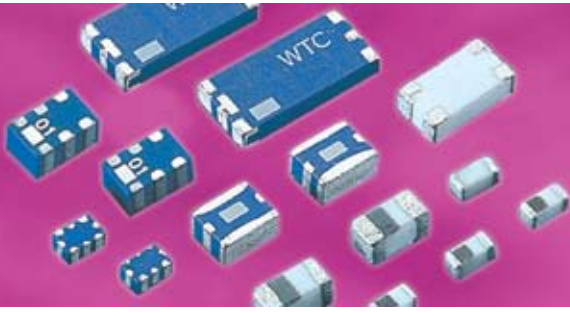

Walsin Technology Corporation



RF Devices and High Frequency Inductors

2008

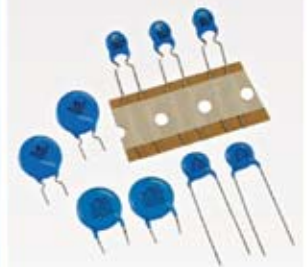

Product Portfolio



Multilayer Ceramic Capacitors (MLCC)

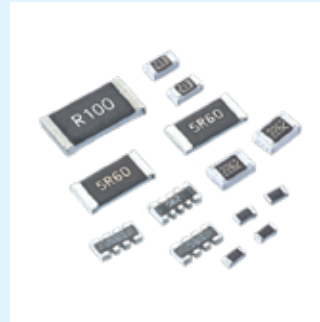

Chip-Resistor



RF Device and High Frequency Inductors



Varistors and SMD-Varistors

IEC-63 Nominal Resistance / Capacitance

| | | | | | | | | | | | | | | | | | | | | | | | | |
|------------|-----|-----|-----|-----|-----|-----|-----|-----|-----|-----|-----|-----|-----|-----|-----|-----|-----|-----|-----|-----|-----|-----|-----|-----|
| E1 | 100 | | | | | | | | | | | | | | | | | | | | | | | |
| E3 | 100 | | | | | | | | 220 | | | | | | | | 470 | | | | | | | |
| E6 | 100 | | | | 150 | | | | 220 | | | | 330 | | | | 470 | | | | 680 | | | |
| E12 | 100 | 120 | 150 | 180 | 220 | 270 | 330 | 390 | 470 | 560 | 680 | 820 | | | | | | | | | | | | |
| E24 | 100 | 110 | 120 | 130 | 150 | 160 | 180 | 200 | 220 | 240 | 270 | 300 | 330 | 360 | 390 | 430 | 470 | 510 | 560 | 620 | 680 | 750 | 820 | 910 |
| E96 | 100 | 102 | 121 | 124 | 147 | 150 | 178 | 182 | 215 | 221 | 261 | 267 | 316 | 324 | 383 | 392 | 464 | 475 | 562 | 576 | 681 | 698 | 825 | 845 |
| | 105 | 107 | 127 | 130 | 154 | 158 | 187 | 191 | 226 | 232 | 274 | 280 | 332 | 340 | 402 | 412 | 487 | 499 | 590 | 604 | 715 | 732 | 866 | 887 |
| | 110 | 113 | 133 | 137 | 162 | 165 | 196 | 200 | 237 | 243 | 287 | 294 | 348 | 357 | 422 | 432 | 511 | 523 | 619 | 634 | 750 | 768 | 909 | 931 |
| | 115 | 118 | 140 | 143 | 169 | 174 | 205 | 210 | 249 | 255 | 301 | 309 | 365 | 374 | 442 | 453 | 536 | 549 | 649 | 665 | 787 | 806 | 953 | 976 |

E6: $\sqrt[6]{10} \approx 1.46$ E12: $\sqrt[12]{10} \approx 1.21$

E1 series resistance: 1Ω, 10Ω, 100Ω, 1000Ω, 10000Ω, 100000Ω

INDEX

| Subject | Page |
|--|-------------|
| 2.4 GHz Bluetooth/WLAN-Chip Antenna 5220 | 1 |
| 2.4 GHz Bluetooth/WLAN-Chip Antenna 3216 | 2 |
| 2.4 GHz Bluetooth/WLAN-Chip Antenna 8010 | 3 |
| 2.4 GHz Bluetooth/WLAN-Free Antenna 9937..... | 4 |
| 2.4 GHz Bluetooth/WLAN-Free Antenna 1903..... | 5 |
| 2.4 GHz High Frequency Devices-Band Pass Filter 3225 | 6 |
| 2.4 GHz High Frequency Devices-Band Pass Filter 2520 | 7~8 |
| 2.4 GHz High Frequency Devices-Band Pass Filter 2012 | 9~11 |
| 2.4 GHz High Frequency Devices-Band Pass Filter 1608 | 12 |
| 2.4 GHz High Frequency Devices-Balanced Filter 2520 | 13~15 |
| 2.4 GHz High Frequency Devices-Balanced Filter 2012 | 16~19 |
| 2.4 GHz High Frequency Devices-Low Pass Filter 2012 | 20 |
| 2.4GHz High Frequency Devices-Balun 2012 | 21~22 |
| 2.4GHz High Frequency Devices-Balun 1608 | 23~24 |
| 2.4/ 4.9/ 5.2/ 5.8 GHz WLAN IEEE802.11 a/b/g Combo-Chip Antenna 6050 | 25~26 |
| 2.4/ 4.9/ 5.2/ 5.8 GHz High Frequency Devices-Diplexer 2012 | 27 |
| 4.9/ 5.2/ 5.8 GHz High Frequency Devices-Balun 2012 | 28 |
| 4.9/ 5.2/ 5.8 GHz High Frequency Devices-Band Pass Filter 2012 | 29 |
| High Frequency Devices-EMI Filter Array | 30~31 |
| High Frequency Inductors | 32~34 |
| High Frequency Devices-Common Mode Filter 1632..... | 35 |
| High Frequency Devices-Common Mode Filter 1220..... | 36~37 |
| High Frequency Devices-Common Mode Filter 1210..... | 38 |
| Multilayer Chip Varistor (MLV) – VZ Series & VH Series | 39~42 |

2.4 GHz Bluetooth/WLAN-Chip Antenna-RFANT5220110A□T

How to Order

| RF | ANT | 522011 | 0 | A | □ | T |
|----------------------------|--------------------------------------|--|--|--|-------------------------------------|---|
| Walsin RF Device | Product code ANT : Antenna | Dimension code 522011 = Length = 52 Width = 20 Thickness = 11 | Unit of dimension 0: 0.1 mm 1: 1.0 mm | Application A: 2.4GHz ISM Band | Specification Design Code | Packing T=7" Reeled G=10" Reeled B=Bulk X: SFC product |

Dimensions

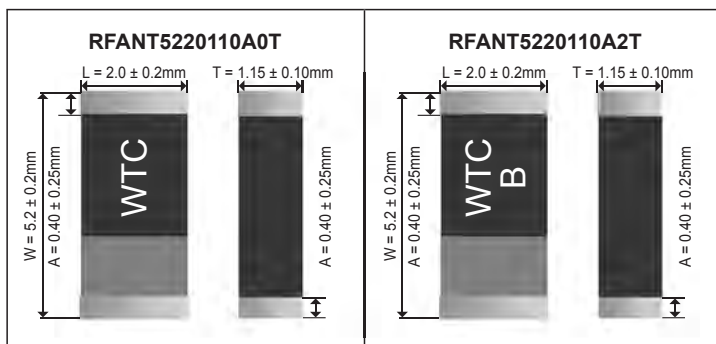

RFANT5220110A□T Series

| Item | Specification |
|-------------------------|-----------------------|
| Working Frequency Range | 2.4 GHz ~ 2.5 GHz |
| Gain | 2 dBi (Typical) |
| VSWR | 2 max. |
| Polarization | Linear |
| Azimuth Bandwidth | Omni-directional |
| Impedance | 50 Ω |
| Rated Power (max.) | 3 Watts |
| Maximum Input Power | 5 Watts for 5 minutes |

Typical Electrical Characteristics:

RFANT5220110A0T

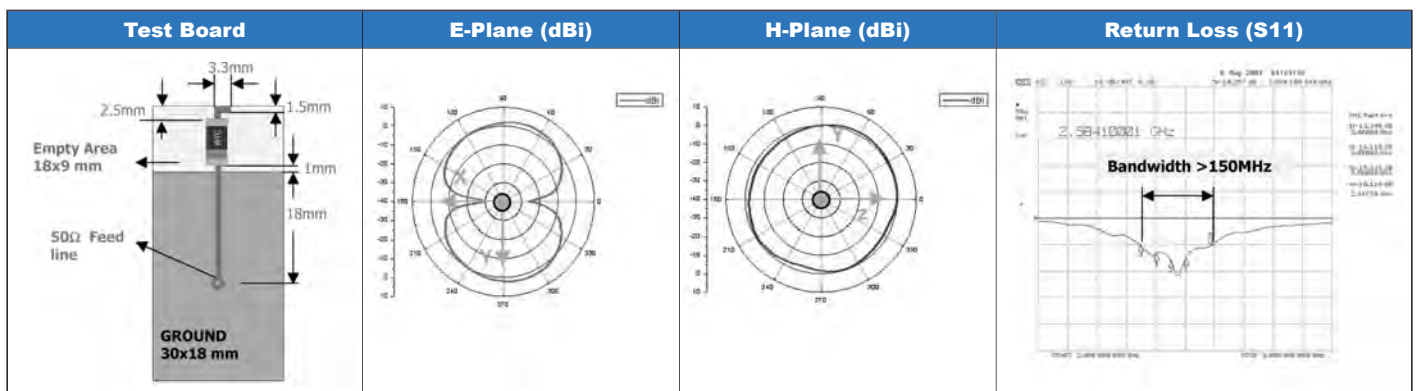

RFANT5220110A2T

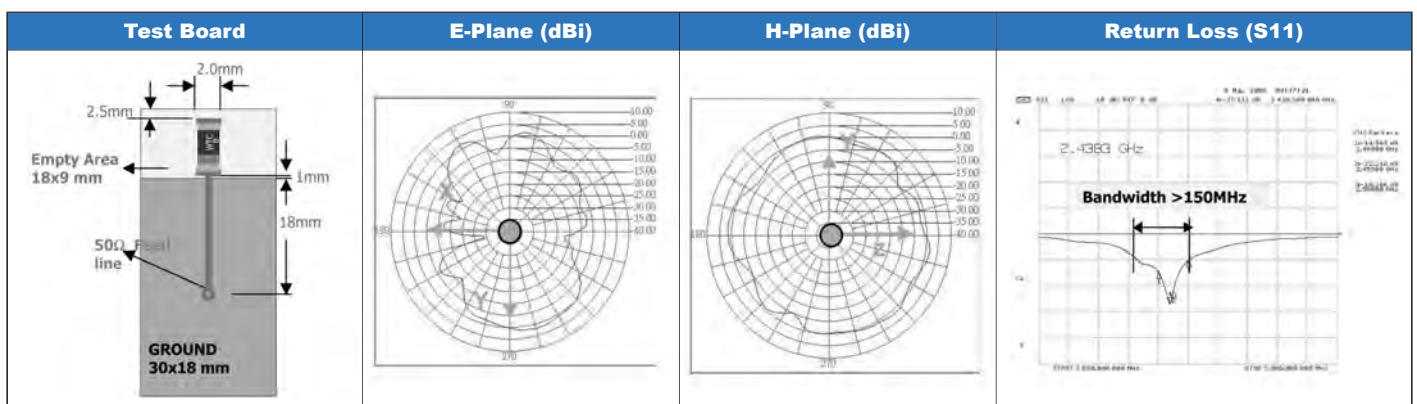

2.4 GHz Bluetooth/WLAN-Chip Antenna-RFANT3216120A□T

How to Order

| RF | ANT | 321612 | 0 | A | □ | T |
|----------------------------|--------------------------------------|--|--|--|-------------------------------------|---|
| Walsin RF Device | Product code ANT : Antenna | Dimension code Per 2 digits of Length, Width, Thickness : e.g. : 321612 = Length32, Width 16, Thickness 12 | Unit of dimension 0: 0.1 mm 1: 1.0 mm | Application A: 2.4GHz ISM Band | Specification Design Code | Packing T=7" Reeled G=10" Reeled B=Bulk X: SFC product |

Dimensions

| Symbol | Dimension |
|--------|----------------|
| L | 3.20 ± 0.20 mm |
| W | 1.60 ± 0.10 mm |
| T | 1.20 ± 0.10 mm |
| a | 0.25 ± 0.15 mm |

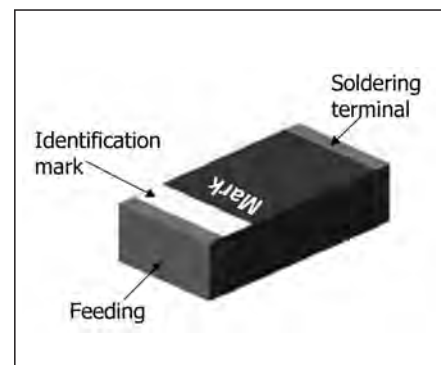
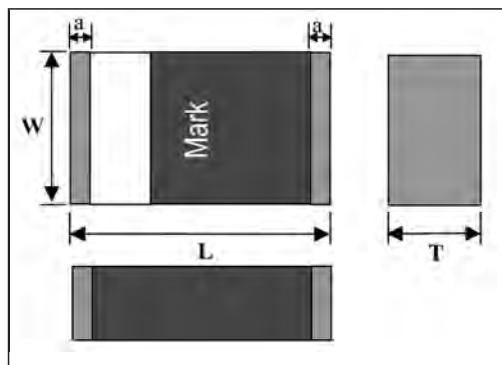

RFANT3216120A□T Series

| Product code | RFANT3216120A1T | RFANT3216120A3T | RFANT3216120A5T |
|--------------------------|-----------------|-----------------|-----------------|
| Working Frequency Range | 2450 ± 50 MHz | 2450 ± 50 MHz | 2450 ± 50 MHz |
| Fc (GHz) | 2.5 | 2.7 | 2.9 |
| Gain (dBi) | 2 (Typical) | 2 (Typical) | 2 (Typical) |
| Matching component value | Series 1 | 2.7 nH | 6.8 nH |
| | Series 2 | - | 1.0 nH |

Typical Electrical Characteristics(RFANT3216120A5T):

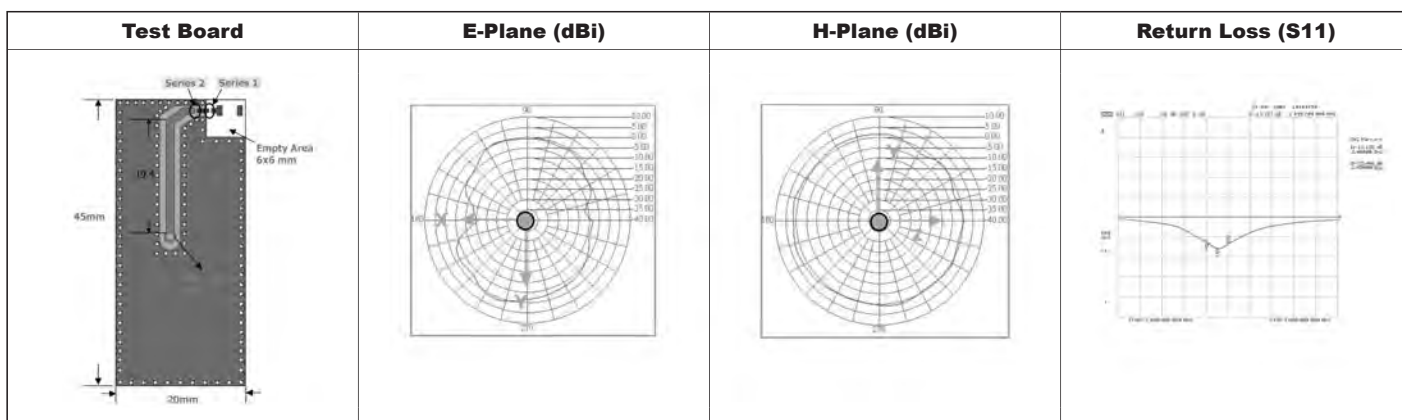

■ 2.4 GHz Bluetooth/WLAN-Chip Antenna-RGANT8010100A0T

■ How to Order

| RG | ANT | 801010 | 0 | A | 0 | T |
|-----------------------------|---------------------|---|--------------------------|--------------------|----------------------|---|
| Walsin | Product code | Dimension code | Unit of dimension | Application | Specification | Packing |
| RG:RF /Pb free device | ANT : Antenna | Per 2 digits of Length, Width, Thickness : e.g. : 801010 = Length80, Width 10, Thickness 10 | 0: 0.1 mm 1: 1.0 mm | A: 2.4GHz ISM Band | Design Code | T=7" Reeled G=10" Reeled B=Bulk X: SFC product |

■ Dimensions

| Symbol | Dimension |
|--------|----------------|
| L | 8.00 ± 0.20 mm |
| W | 1.00 ± 0.20 mm |
| T | 1.00 ± 0.20 mm |
| A | 0.50 ± 0.30 mm |

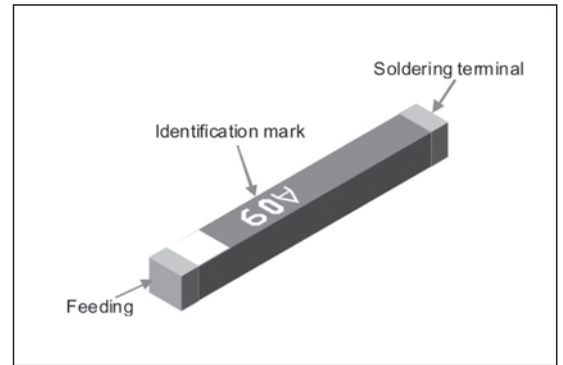
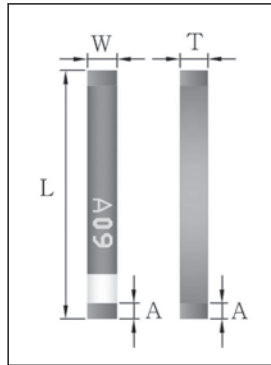

■ RGANT8010100A0T Series

| Item | Specification |
|-------------------------|-----------------------|
| Working Frequency Range | 2.4 GHz ~ 2.5 GHz |
| Gain | 2 dBi (Typical) |
| VSWR | 2 max |
| Polarization | Linear |
| Azimuth Bandwidth | Omni-directional |
| Impedance | 50 Ω |
| Rated Power (max) | 3 Watts |
| Maximum Input Power | 5 Watts for 5 minutes |
| Operation Temperature | -40°C ~ +85°C |

■ Typical Electrical Characteristics:

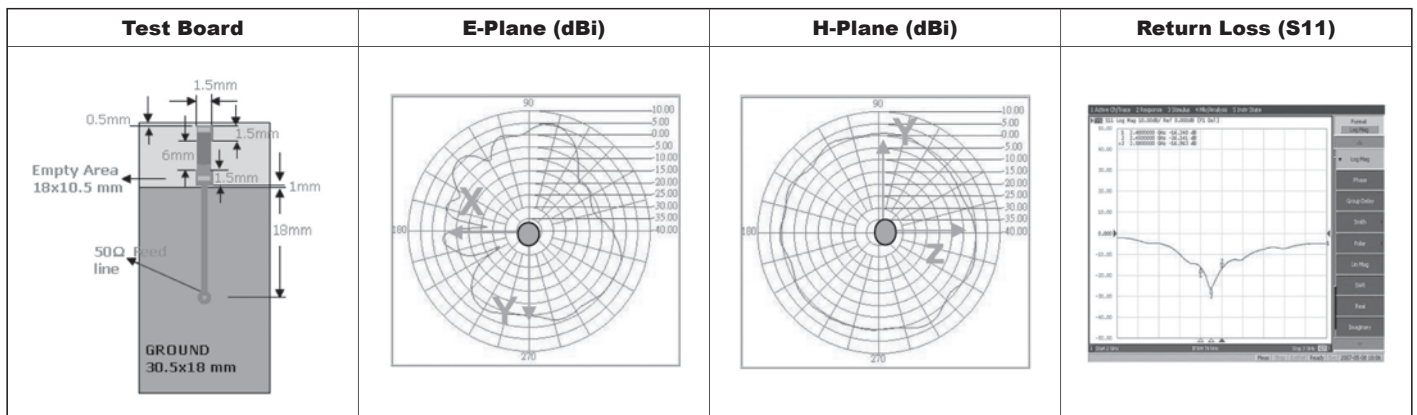

2.4 GHz Bluetooth/WLAN-Free Antenna-RGFRA9937380A3T

How to Order

| RG | FRA | 993738 | 0 | A | 3 | T |
|---|-------------------------------------|--|--|--|-------------------------------------|---|
| Walsin RG: RF Device /Pb free device | Product code FRA: Antenna | Dimension code Per 2 digits of Length, Width, Thickness : e.g. : 993738 = Length99, Width 37, Thickness 38 | Unit of dimension 0: 0.1 mm 1: 1.0 mm | Application A: 2.4GHz ISM Band | Specification Design Code | Packing T=7" Reeled G=10" Reeled B=Bulk X: SFC product |

Dimensions

| Dimension | Port definition |
|----------------|-----------------------|
| L | - |
| W | - |
| T | - |
| P _w | Pad width |
| P ₁ | Soldering termination |
| P ₂ | Feed termination |
| P ₃ | Ground termination |

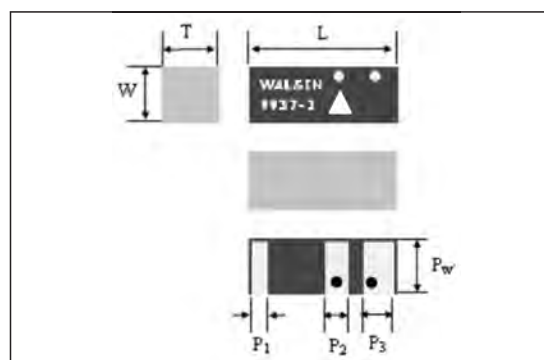

RGFRA9937380A3T Series

| Item | Specification |
|-------------------------|------------------|
| Central Frequency (GHz) | Marking |
| | 9937-3 |
| | Frequency (GHz) |
| | 2.55 GHz |
| Gain | 2 dBi (Typical) |
| VSWR | 2 max. |
| Polarization | Linear |
| Azimuth Bandwidth | Omni-directional |
| Impedance | 50 Ω |
| Rated Power (max.) | 1 Watts |
| Operation Temperature | -40°C ~ +85°C |

Typical Electrical Characteristics:

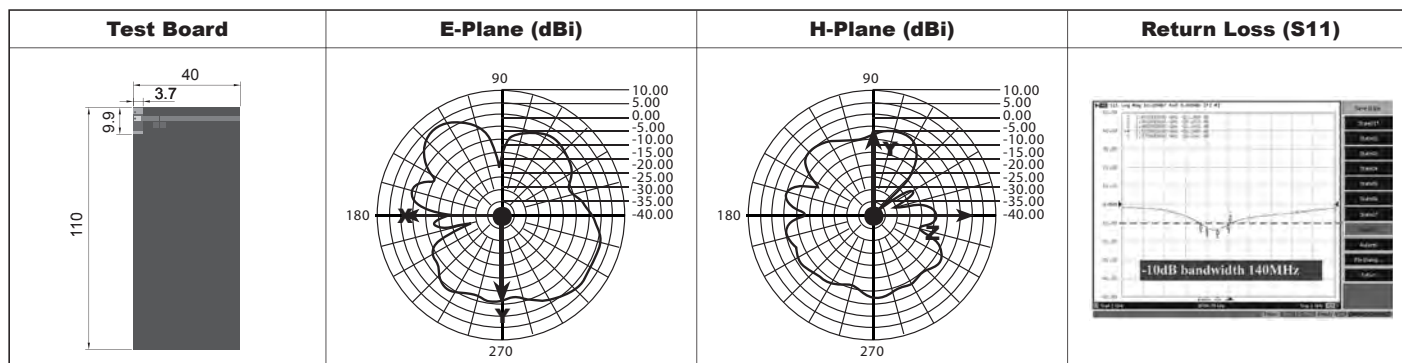

■ 2.4 GHz Bluetooth/WLAN-Free Antenna-RGFRA1903041A1T

■ How to Order

| RG | FRA | 190304 | 1 | A | 1 | T |
|--|--------------------------------------|---|--|--|-------------------------------------|---|
| Walsin RG: RF / Pb free device | Product code FRA : Antenna | Dimension code Per 2 digits of Length, Width, Thickness : e.g. : 190304 = Length19, Width 3.0 Thickness 3.8 | Unit of dimension 0: 0.1 mm 1: 1.0 mm | Application A: 2.4GHz ISM Band | Specification Design Code | Packing T=7" Reeled G=10" Reeled B=Bulk X: SFC product |

■ Dimensions

| Dimension | Port definition |
|----------------|--|
| L | 19.0 ± 0.15 mm |
| W | 3.0 ± 0.15 mm |
| T | 3.8 ± 0.20 mm |
| P _w | 3.0 ± 0.10 mm Pad width |
| P ₁ | 1.0 ± 0.10 mm Soldering termination |
| P ₂ | 1.0 ± 0.10 mm Soldering termination |
| P ₃ | 1.0 ± 0.10 mm Feed termination |
| P ₄ | 1.0 ± 0.10 mm Ground termination |

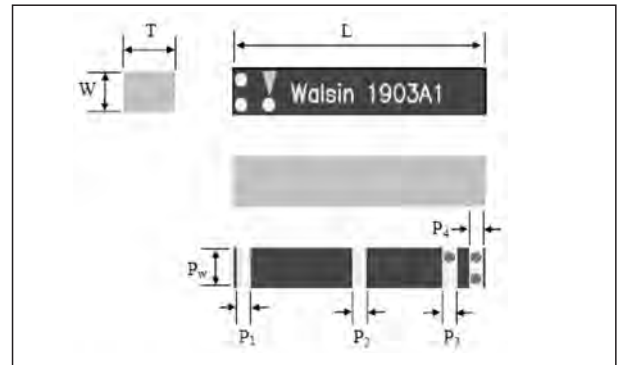

■ RGFRA1903041A1T Series

| Item | Specification |
|-----------------------|------------------|
| Central Frequency | 2.450 GHz |
| Gain | 2 dBi (Typical) |
| VSWR | 2 max. |
| Polarization | Linear |
| Azimuth Bandwidth | Omni-directional |
| Impedance | 50 Ω |
| Rated Power (max.) | 1 Watts |
| Operation Temperature | -40°C ~ +85°C |

■ Typical Electrical Characteristics:

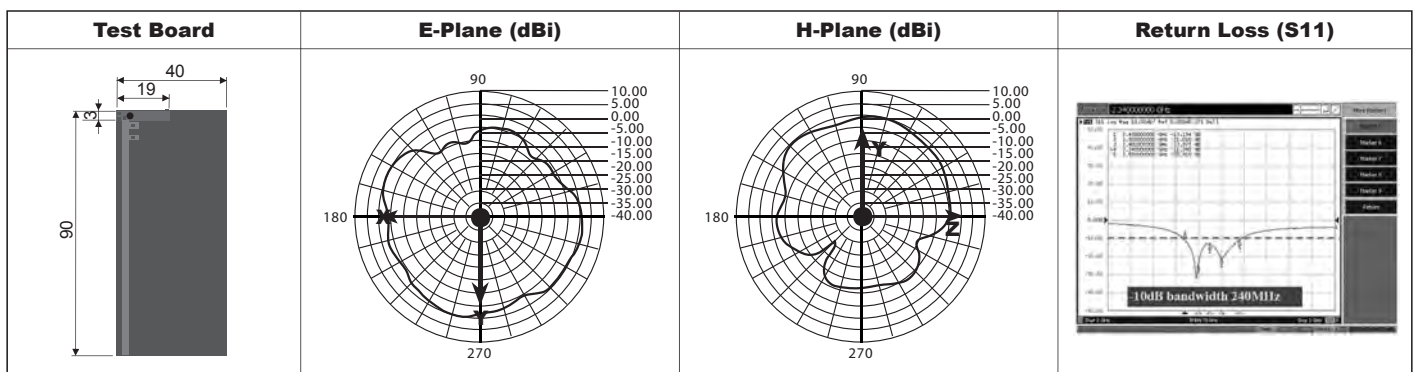

2.4 GHz High Frequency Devices-Band Pass Filter-RFBPF3225150A□T

How to Order

| RF | BPF | 322515 | 0 | A | □ | T |
|----------------------------|---|--|--|--|-------------------------------------|---|
| Walsin RF Device | Product code BPF : Band Pass Filter | Dimension code 322515 = Length = 32 Width = 25 Thickness = 15 | Unit of dimension 0: 0.1 mm 1: 1.0 mm | Application A: 2.4GHz ISM Band | Specification Design Code | Packing T=7" Reeled G=10" Reeled B=Bulk X: SFC product |

Dimensions

| Symbol | Dimension |
|--------|----------------|
| L | 3.20 ± 0.20 mm |
| W | 2.50 ± 0.20 mm |
| T | 1.50 ± 0.10 mm |
| A | 0.40 ± 0.20 mm |
| B | 0.60 ± 0.20 mm |
| C | 0.70 ± 0.20 mm |
| D | 0.20 ± 0.15 mm |

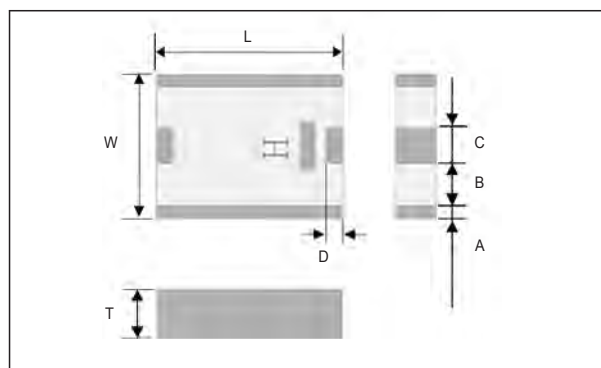

RFBPF3225150A□T Series

| Item | Specification | |
|-----------------------|-----------------|-----------------|
| | RFBPF3225150A4T | RFBPF3225150A5T |
| Frequency range (MHz) | 2450 ± 50 MHz | 2450 ± 50 MHz |
| Insertion Loss | 2.0 dB (max) | 1.8 dB (max) |
| VSWR | 2.0 (max) | 2.0 (max) |
| Impedance | 50 Ω | 50 Ω |
| Attenuation (min.) | 30 dB @900 MHz | 30 dB @900 MHz |
| | 30 dB @1850 MHz | 30 dB @1850 MHz |
| | 20 dB @2100 MHz | 20 dB @2100 MHz |
| | 30 dB @4800 MHz | 30 dB @4800 MHz |

Typical Electrical Characteristics:

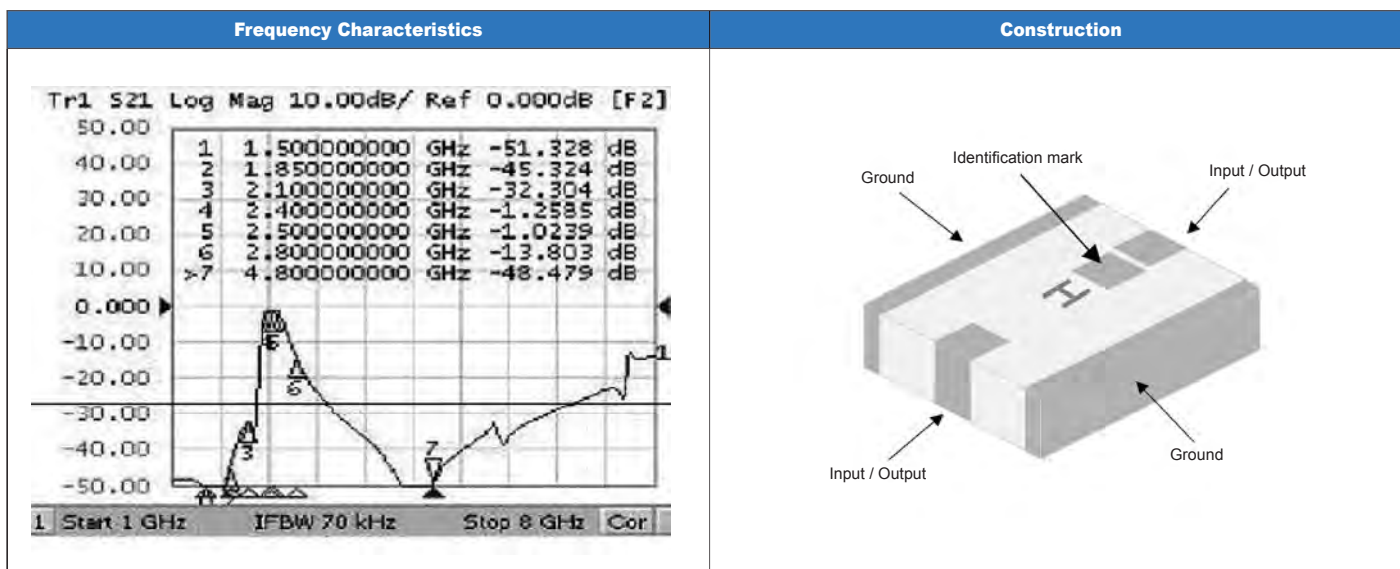

2.4 GHz High Frequency Devices-Band Pass Filter-RFBPF2520120A□T

How to Order

| RF | BPF | 252012 | 0 | A | □ | T |
|----------------------------|---|--|--|--|-------------------------------------|---|
| Walsin RF Device | Product code BPF : Band Pass Filter | Dimension code Per 2 digits of Length, Width, Thickness : e.g. : 252012 = Length25, Width 20, Thickness 12 | Unit of dimension 0: 0.1 mm 1: 1.0 mm | Application A: 2.4GHz ISM Band | Specification Design Code | Packing T=7" Reeled G=10" Reeled B=Bulk X: SFC product |

Dimensions

| Symbol | Dimension |
|--------|----------------|
| L | 2.50 ± 0.20 mm |
| W | 2.00 ± 0.20 mm |
| T | 1.20 ± 0.10 mm |
| A | 0.25 ± 0.20 mm |
| B | 0.50 ± 0.20 mm |
| C | 0.50 ± 0.20 mm |

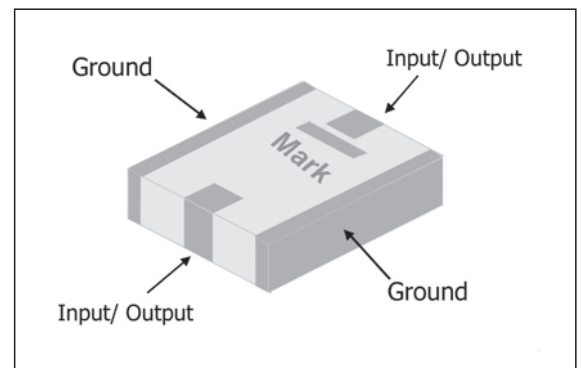
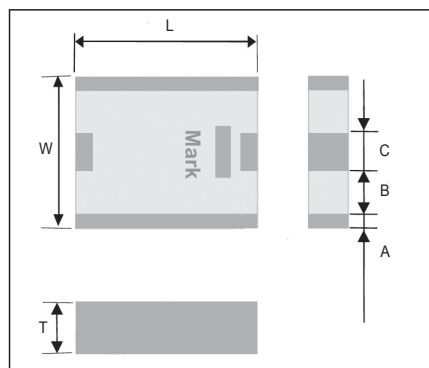

RFBPF2520120A□T Series

| Item | Specification | | | |
|-----------------------|--|--|--|--|
| | RFBPF2520120A1T | RFBPF2520120A2T | RFBPF2520120A3T | RFBPF2520120A4T |
| Frequency range (MHz) | 2450 ± 50 MHz | 2450 ± 50 MHz | 2450 ± 50 MHz | 2450 ± 50 MHz |
| Insertion Loss | 1.7 dB (max) | 2.1 dB (max) | 1.2 dB (max) | 1.7 dB (max) |
| VSWR | 2.0 (max) | 2.0 (max) | 2.0 (max) | 2.0 (max) |
| Impedance | 50 Ω | 50 Ω | 50 Ω | 50 Ω |
| Attenuation (min.) | 30 dB @900 MHz 30 dB @1850 MHz 20 dB @2100 MHz 40 dB @4800 MHz 25 dB @7200 MHz | 30 dB @900 MHz 30 dB @1850 MHz 30 dB @4800 MHz | 30 dB @900 MHz 30 dB @1850 MHz 25 dB @4800 MHz | 30 dB @900 MHz 30 dB @1850 MHz 30 dB @4800 MHz |

Typical Electrical Characteristics:

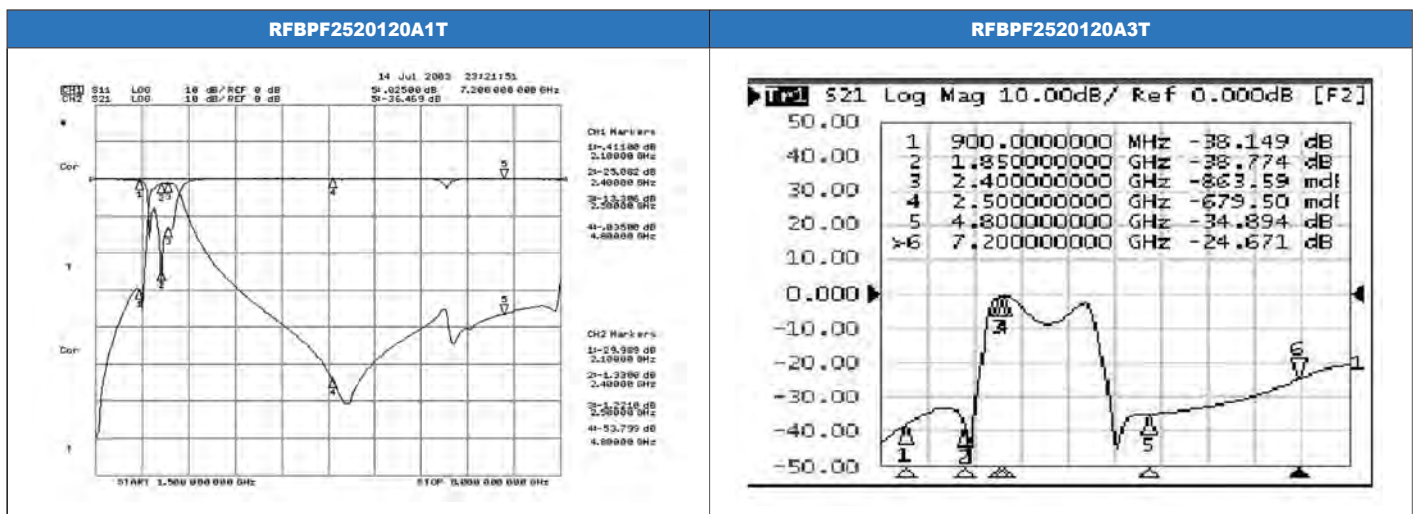

2.4 GHz High Frequency Devices-Band Pass Filter-RFBPF2520100A□T

How to Order

| RF | BPF | 252010 | 0 | A | □ | T |
|----------------------------|---|--|--|--|-------------------------------------|---|
| Walsin RF Device | Product code BPF : Band Pass Filter | Dimension code Per 2 digits of Length, Width, Thickness : e.g. : 252010 = Length25, Width 20, Thickness 10 | Unit of dimension 0: 0.1 mm 1: 1.0 mm | Application A: 2.4GHz ISM Band | Specification Design Code | Packing T=7" Reeled G=10" Reeled B=Bulk X: SFC product |

Dimensions

| Symbol | RFBPF2520100A5T | RFBPF2520100A6T |
|--------|-----------------|-----------------|
| L | 2.50 ± 0.20 mm | 2.50 ± 0.20 mm |
| W | 2.00 ± 0.20 mm | 2.00 ± 0.20 mm |
| T | 1.00 ± 0.10 mm | 1.05 ± 0.10 mm |
| A | 0.20 ± 0.20 mm | 0.25 ± 0.20 mm |
| B | 0.50 ± 0.20 mm | 0.50 ± 0.20 mm |
| C | 0.50 ± 0.20 mm | 0.50 ± 0.20 mm |

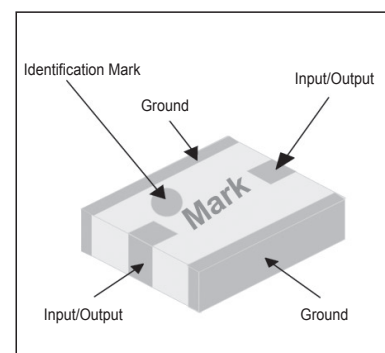
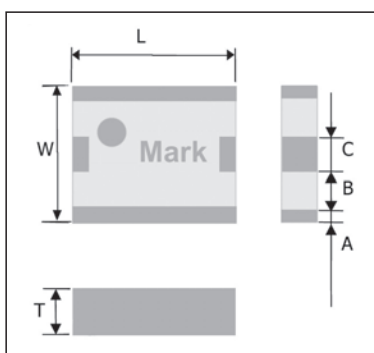

RFBPF2520100A□T Series

| Item | Specification | |
|-----------------------|---|------------------------------------|
| | RFBPF2520100A5T | RFBPF2520100A6T |
| Frequency range (MHz) | 2450 ± 50 MHz | 2450 ± 50 MHz |
| Insertion Loss | 2 dB max | 1.4 dB max |
| VSWR | 2.0 (max) | 2.0 (max) |
| Impedance | 50 Ω | 50 Ω |
| Attenuation (min.) | 40 dB @900 MHz 30 dB @1990 MHz 20 dB @2100 MHz 35 dB @3200 MHz 40 dB @4800 MHz 25dB @7200 MHz* (* for reference) | 35 dB @1900 MHz 35 dB @4800 MHz |

Typical Electrical Characteristics:

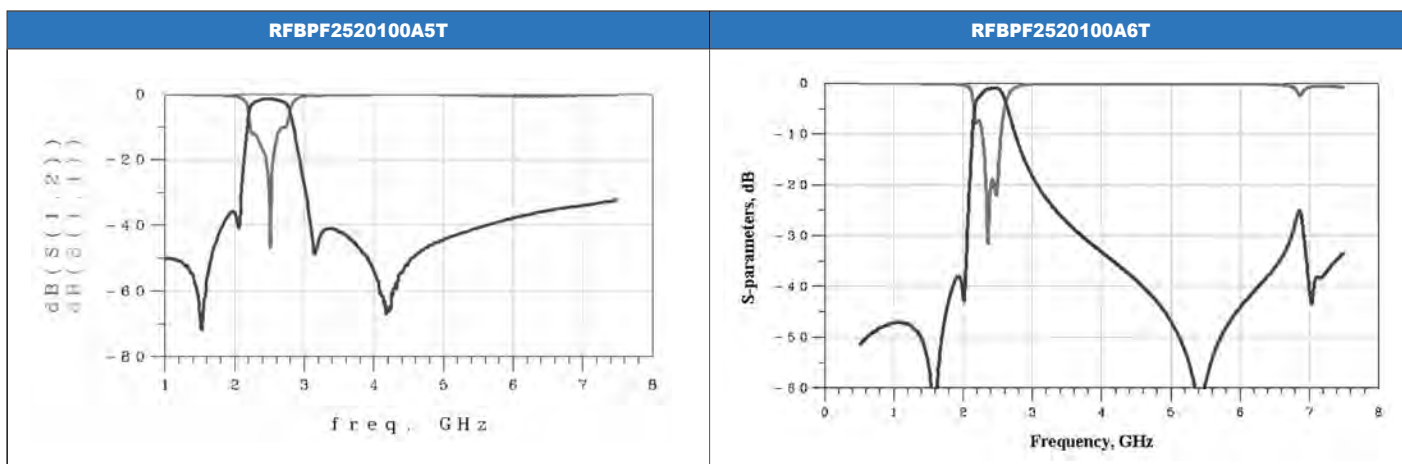

■ 2.4 GHz High Frequency Devices-Band Pass Filter-RFBPF2012090A1T

■ How to Order

| RF | BPF | 201209 | 0 | A | 1 | T |
|-----------------------------------|---|--|--|--|-------------------------------------|---|
| Walsin Walsin RF Device | Product code BPF : Band Pass Filter | Dimension code Per 2 digits of Length, Width, Thickness : e.g. : 201209 = Length20, Width 12, Thickness 09 | Unit of dimension 0: 0.1 mm 1: 1.0 mm | Application A: 2.4GHz ISM Band | Specification Design Code | Packing T=7" Reeled G=10" Reeled B=Bulk X: SFC product |

■ Dimensions

| Symbol | Dimension |
|--------|----------------|
| L | 2.00 ± 0.15 mm |
| W | 1.25 ± 0.15 mm |
| T | 0.90 ± 0.10 mm |
| A | 1.00 ± 0.15 mm |
| B | 0.30 ± 0.15 mm |
| C | 0.50 ± 0.15 mm |
| D | 0.25 ± 0.15 mm |
| E | 0.25 ± 0.15 mm |

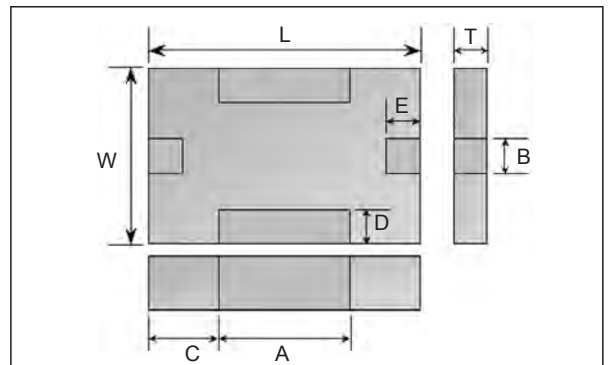

■ RFBPF2012090A1T Series

| Item | Specification |
|-----------------------|--|
| Frequency range (MHz) | 2450 ± 50 MHz |
| Insertion Loss | 1.7 dB max |
| VSWR | 2.0 (max) |
| Impedance | 50 Ω |
| Attenuation (min.) | 30 dB @900 MHz 20 dB @1850 MHz 30 dB @4800 MHz |

■ Typical Electrical Characteristics:

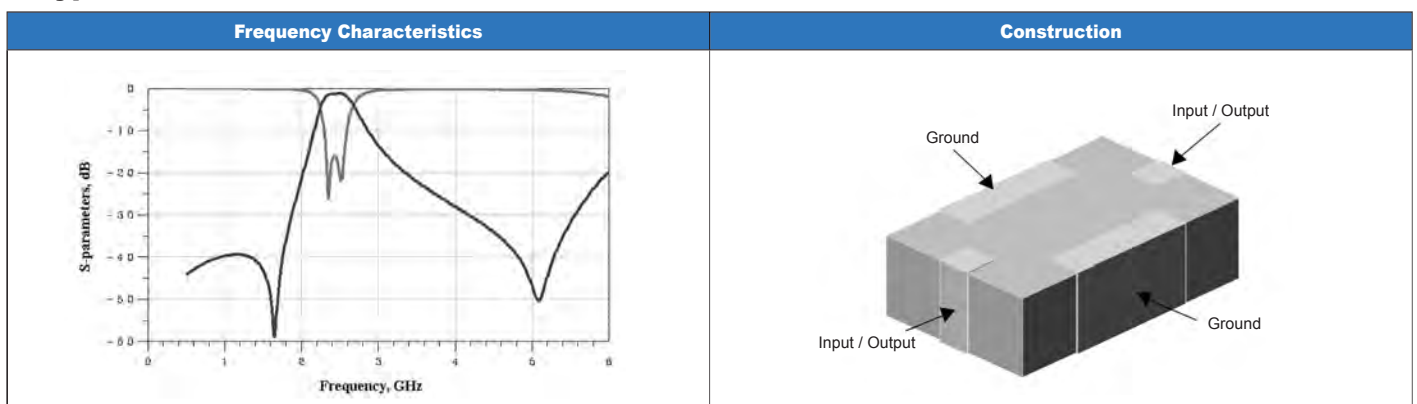

2.4 GHz High Frequency Devices-Band Pass Filter-RFBPF2012080A5T

How to Order

| RF | BPF | 201208 | 0 | A | 5 | T |
|----------------------------|---|---|--|--|-------------------------------------|---|
| Walsin RF Device | Product code BPF : Band Pass Filter | Dimension code Per 2 digits of Length, Width, Thickness : e.g. : 201208 = Length 20, Width 12, Thickness 08 | Unit of dimension 0: 0.1 mm 1: 1.0 mm | Application A: 2.4GHz ISM Band | Specification Design Code | Packing T=7" Reeled G=10" Reeled B=Bulk X: SFC product |

Dimensions

| Symbol | Dimension |
|--------|--------------|
| L | 2.0 ± 0.2 mm |
| W | 1.2 ± 0.2 mm |
| T | 0.8 ± 0.1 mm |
| A | 0.4 ± 0.2 mm |
| B | 0.4 ± 0.2 mm |
| C | 0.4 ± 0.2 mm |
| D | 0.2 ± 0.1 mm |

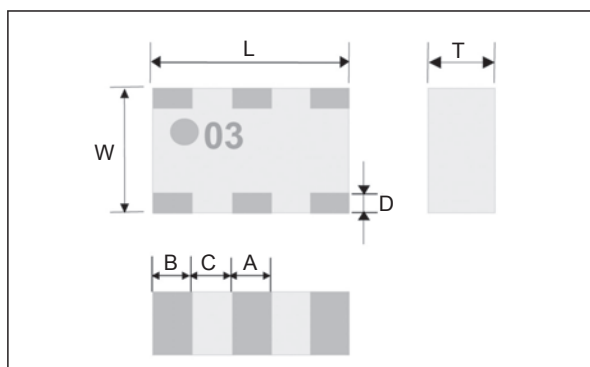

RFBPF2012080A5T Series

| Item | Specification |
|-----------------------|--|
| Frequency range (MHz) | 2450 ± 50 MHz |
| Insertion Loss | 3 dB (max) |
| VSWR | 2.0 (max) |
| Impedance | 50 Ω |
| Attenuation (min.) | 40 dB @880~960 MHz 40 dB @1710~1990 MHz 20 dB @2110~2170 MHz 40 dB @4800~5000 MHz 30 dB @7200~7500 MHz |

Typical Electrical Characteristics:

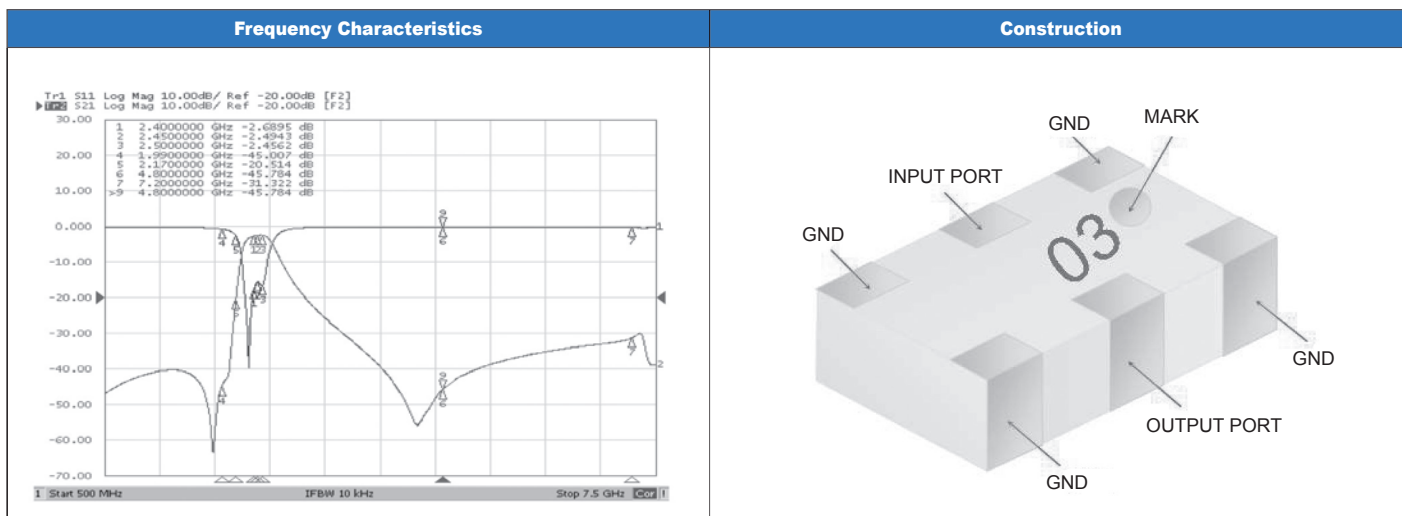

■ 2.4 GHz High Frequency Devices-Band Pass Filter-RFBPF2012080A7T

■ How to Order

| RF | BPF | 201208 | 0 | A | 7 | T |
|----------------------------|---|---|--|--|-------------------------------------|---|
| Walsin RF Device | Product code BPF : Band Pass Filter | Dimension code Per 2 digits of Length, Width, Thickness : e.g. : 201208 = Length 20, Width 12, Thickness 08 | Unit of dimension 0: 0.1 mm 1: 1.0 mm | Application A: 2.4GHz ISM Band | Specification Design Code | Packing T=7" Reeled G=10" Reeled B=Bulk X: SFC product |

■ Dimensions

| Symbol | Dimension |
|--------|----------------|
| L | 2.00 ± 0.15 mm |
| W | 1.25 ± 0.15 mm |
| T | 0.75 ± 0.10 mm |
| A | 1.00 ± 0.15 mm |
| B | 0.30 ± 0.15 mm |
| C | 0.50 ± 0.15 mm |
| D | 0.25 ± 0.15 mm |
| E | 0.25 ± 0.15 mm |

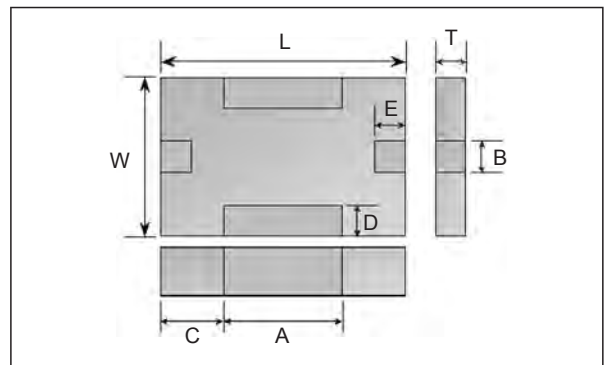

■ RFBPF2012080A7T Series

| Item | Specification |
|-----------------------|--|
| Frequency range (MHz) | 2450 ± 50 MHz |
| Insertion Loss | 3 dB (max) |
| VSWR | 2.0 (max) |
| Impedance | 50 Ω |
| Attenuation (min.) | 40 dB @DC~1600 MHz 18 dB @1600~2000 MHz 30 dB @3000~3100 MHz 35 dB @4800~5000 MHz 20 dB @7200~7500 MHz |

■ Typical Electrical Characteristics:

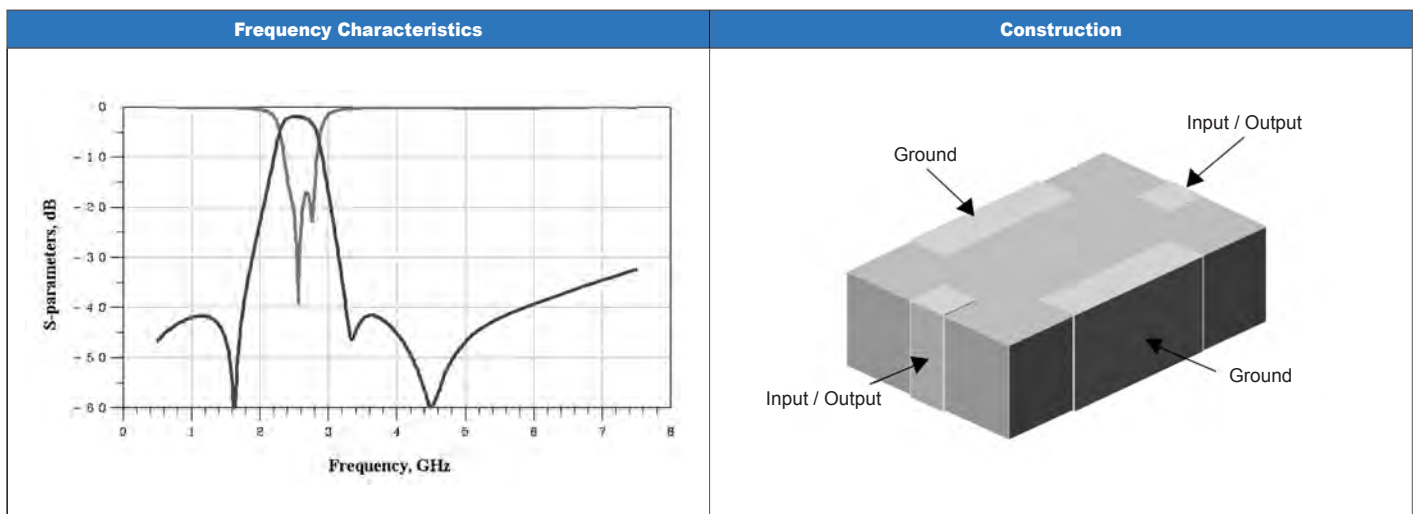

2.4 GHz High Frequency Devices-Band Pass Filter-RFBPF1608070A0T

How to Order

| RF | BPF | 160807 | 0 | A | 0 | T |
|----------------------------|---|--|--|--|-------------------------------------|---|
| Walsin RF Device | Product code BPF : Band Pass Filter | Dimension code Per 2 digits of Length, Width, Thickness : e.g. : 160807 = Length16, Width 08, Thickness 07 | Unit of dimension 0: 0.1 mm 1: 1.0 mm | Application A: 2.4GHz ISM Band | Specification Design Code | Packing T=7" Reeled G=10" Reeled B=Bulk X: SFC product |

Dimensions

| Symbol | Dimension |
|--------|----------------|
| L | 1.60 ± 0.15 mm |
| W | 0.80 ± 0.15 mm |
| T | 0.70 ± 0.10 mm |
| A | 0.70 ± 0.15 mm |
| B | 0.30 ± 0.15 mm |
| C | 0.45 ± 0.15 mm |
| D | 0.15 ± 0.10 mm |
| E | 0.15 ± 0.10 mm |

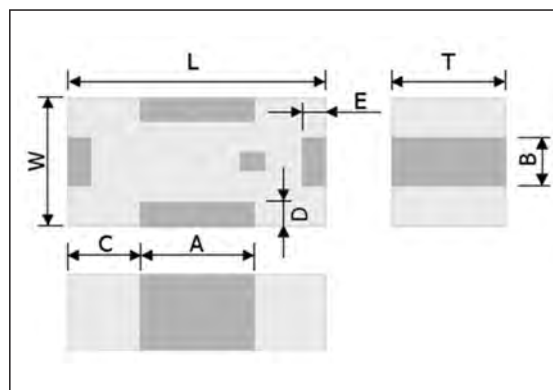

RFBPF1608070A0T Series

| Item | Specification |
|-----------------------|--|
| Frequency range (MHz) | 2450 ± 50 MHz |
| Insertion Loss | 2.5 dB (max) |
| VSWR | 2.0 (max) |
| Impedance | 50 Ω |
| Attenuation (min.) | 30 dB @960 MHz 25 dB @1910 MHz 20 dB @1990 MHz 30 dB @4800 MHz 25 dB @7200 MHz |

Typical Electrical Characteristics:

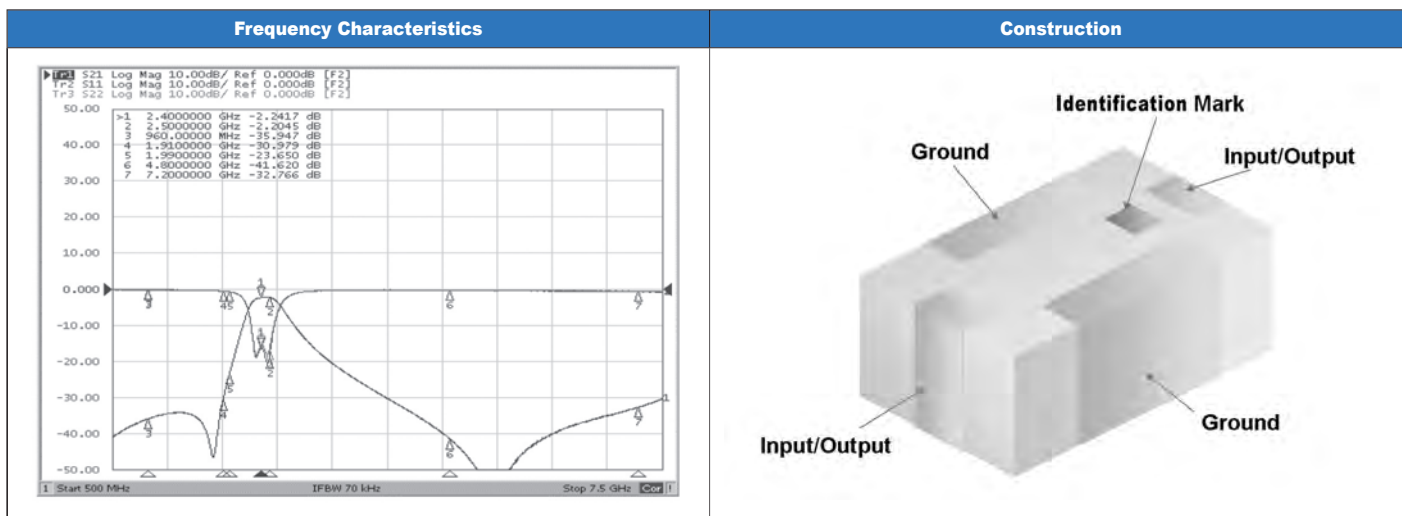

2.4 GHz High Frequency Devices-Balanced Filter-RFBPB2520120A□T

How to Order

| RF | BPB | 252012 | 0 | A | □ | T |
|---------------------------------|---|--|--|--|-------------------------------------|---|
| Walsin RF : device | Product code BPB : Balanced Type Band Pass Filter | Dimension code Per 2 digits of Length, Width, Thickness : e.g. : 252012 = Length25, Width 20, Thickness 12 | Unit of dimension 0: 0.1 mm 1: 1.0 mm | Application A: 2.4GHz ISM Band | Specification Design Code | Packing T=7" Reeled G=10" Reeled B=Bulk X: SFC product |

Dimensions

| Symbol | Dimension (mm) |
|--------|----------------|
| L | 2.50±0.2/-0.10 |
| W | 2.00±0.2/-0.10 |
| T | 1.20±0.1/-0.20 |
| a | 0.30 ± 0.20 |
| c | 1.00 ± 0.10 |
| d | 0.30 ± 0.20 |
| P | 0.80 ± 0.20 |

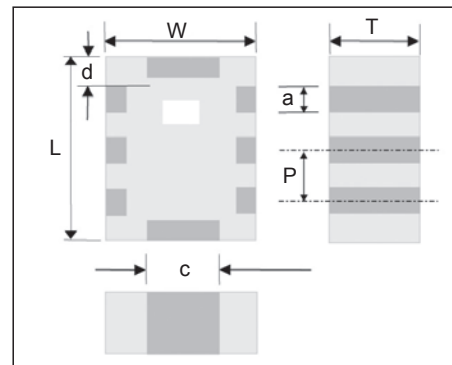

RFBPB2520120A□T Series

| Item | Specification | |
|------------------------|---|---|
| | RFBPB2520120A1T | RFBPB2520120A2T |
| Frequency range (MHz) | 2450 ± 50 | 2450 ± 50 |
| Insertion Loss (dB) | 2.0 max | 2.2 max |
| VSWR | 2.0 max | 2.0 max |
| Impedance (Unbalanced) | 50 Ω | 50 Ω |
| Impedance (Balanced) | 100 Ω | 100 Ω |
| Phase Difference | 180° ± 10° | 180° ± 10° |
| Amplitude Difference | 1.2 dB max | 1.4 dB max |
| Attenuation (dB min.) | 25 @900 MHz 25 @1900 MHz 30 @4800 MHz 20 @7200 MHz (reference) | 25 @900 MHz 25 @1900 MHz 30 @4800 MHz 15 @7200 MHz (reference) |

Typical Electrical Characteristics(RFBPB2520120A1T):

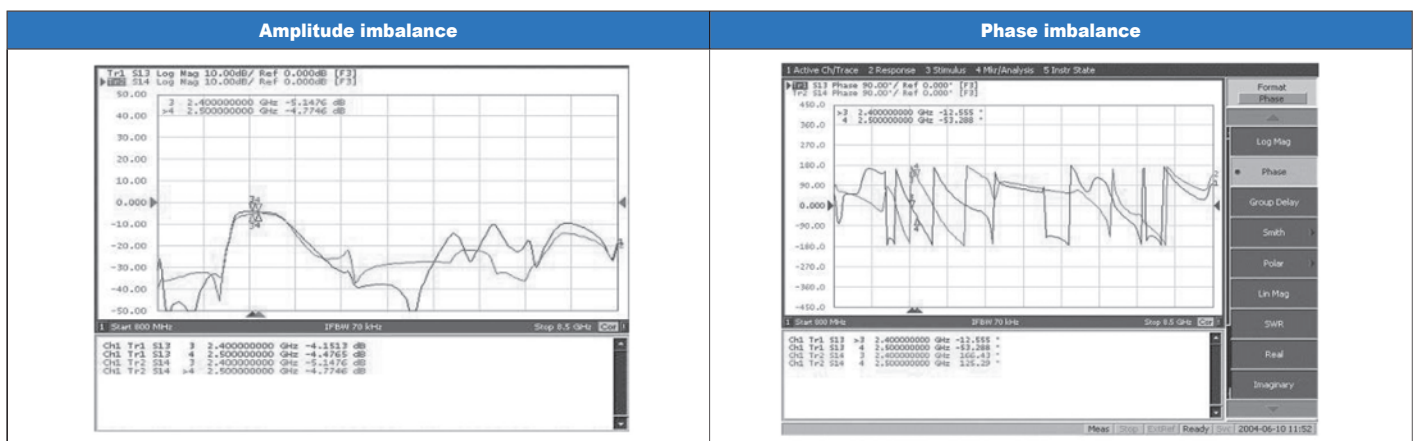

2.4 GHz High Frequency Devices-Balanced Filter-RGBPB2520090A□T

How to Order

| RG | BPB | 252009 | 0 | A | □ | T |
|----------------------------|---|---|--------------------------|--------------------|----------------------|---|
| Walsin | Product code | Dimension code | Unit of dimension | Application | Specification | Packing |
| RG : RF /Pb free device | BPB : Balanced Type Band Pass Filter | Per 2 digits of Length, Width, Thickness : e.g. : 252009 = Length25, Width 20, Thickness 09 | 0: 0.1 mm 1: 1.0 mm | A: 2.4GHz ISM Band | Design Code | T=7" Reeled G=10" Reeled B=Bulk X: SFC product |

Dimensions

| Symbol | Dimension |
|--------|----------------|
| L | 2.50 ± 0.20 mm |
| W | 2.00 ± 0.20 mm |
| T | 0.95 ± 0.10 mm |
| a | 0.40 ± 0.10 mm |
| b | 0.25 ± 0.10 mm |
| c | 1.83 ± 0.10 mm |
| d | 0.40 ± 0.10 mm |
| p | 0.80 ± 0.20 mm |

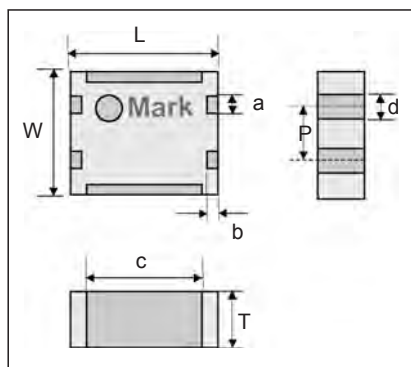

Pin Arrangement

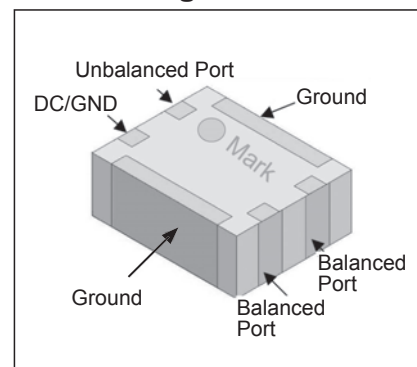

RGBPB2520090A□T Series

| Item | Specification | |
|------------------------|--|--|
| | RGBPB2520090A5T | RGBPB2520090A6T |
| Frequency range (MHz) | 2450 ± 50 MHz | 2450 ± 50 MHz |
| Insertion Loss | 3 dB max | 3.5 dB max |
| VSWR | 2.0 max | 2.0 max |
| Impedance (Unbalanced) | 50 Ω | 50 Ω |
| Impedance (Balanced) | Match to BC series of Bluetooth chipset | Match to BC series of Bluetooth chipset |
| Phase Difference | 180° ± 15° | 180° ± 15° |
| Amplitude Difference | 1.5 dB max | 1.5 dB max |
| Attenuation (min.) | 40 dB @880~960 MHz 40 dB @1710~1880 MHz 20 dB @1880~1990 MHz 30 dB @4800~5000 MHz | 40 dB @880~960 MHz 40 dB @1710~1880 MHz 20 dB @1880~1990 MHz 30 dB @4800~5000 MHz |

Typical Electrical Characteristics(RGBPB2520090A5T):

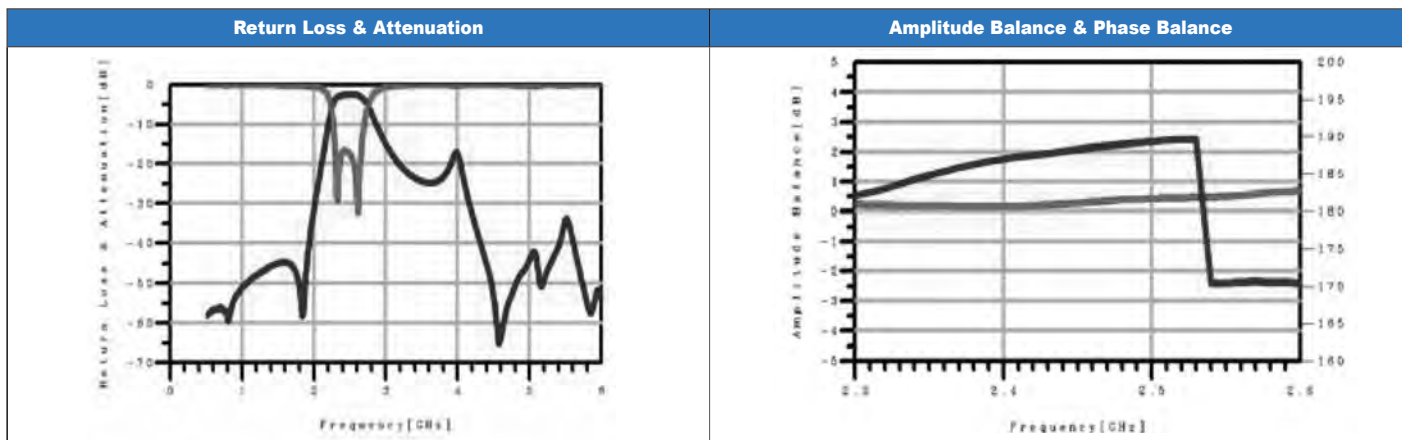

2.4 GHz High Frequency Devices-Balanced Filter-RFBPB2520090A7T

How to Order

| RF | BPB | 252009 | 0 | A | 7 | T |
|---------------|--|---|--------------------------|--------------------|----------------------|---|
| Walsin | Product code | Dimension code | Unit of dimension | Application | Specification | Packing |
| RF Device | BPB : Balanced Type Band Pass Filter | Per 2 digits of Length, Width, Thickness : e.g. : 252009 = Length25, Width 20, Thickness 09 | 0: 0.1 mm 1: 1.0 mm | A: 2.4GHz ISM Band | Design Code | T=7" Reeled G=10" Reeled B=Bulk X: SFC product |

Dimensions

| Symbol | Dimension |
|--------|----------------|
| L | 2.50 ± 0.20 |
| W | 2.00 ± 0.20 |
| T | 0.85 ± 0.10 |
| a | 0.35 ± 0.20 |
| b | 0.4 ± 0.20 |
| c | 0.30 ± 0.20 |
| d | 0.70 ± 0.20 |
| e | 1.20 ± 0.20 |
| f | 0.15 (Typical) |
| g | 0.15 (Typical) |

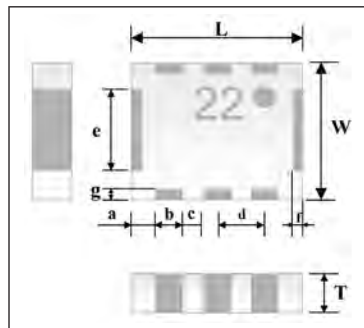

Pin Arrangement

| PIN | Definition | PIN | Definition |
|-----|-----------------|-----|---------------|
| P1 | NC | P5 | Balanced Port |
| P2 | Unbalanced Port | P6 | Balanced Port |
| P3 | DC | P7 | GND |
| P4 | GND | P8 | GND |

RFBPB2520090A7T Series

| Item | Specification |
|------------------------|--|
| Frequency range (MHz) | 2450 ± 50 |
| Insertion Loss (dB) | 3.5 max |
| VSWR | 2.0 max |
| Impedance (Unbalanced) | 50 Ω |
| Impedance (Balanced) | Conjugate match to BRF6150 of TI |
| Phase Difference | 180° ± 15° |
| Amplitude Difference | 1.5dB max |
| Attenuation (dB min.) | 35 @880-960 MHz 30 @1710-1880 MHz 25 @1880-1990 MHz 25 @4800-5000 MHz |

Typical Electrical Characteristics:

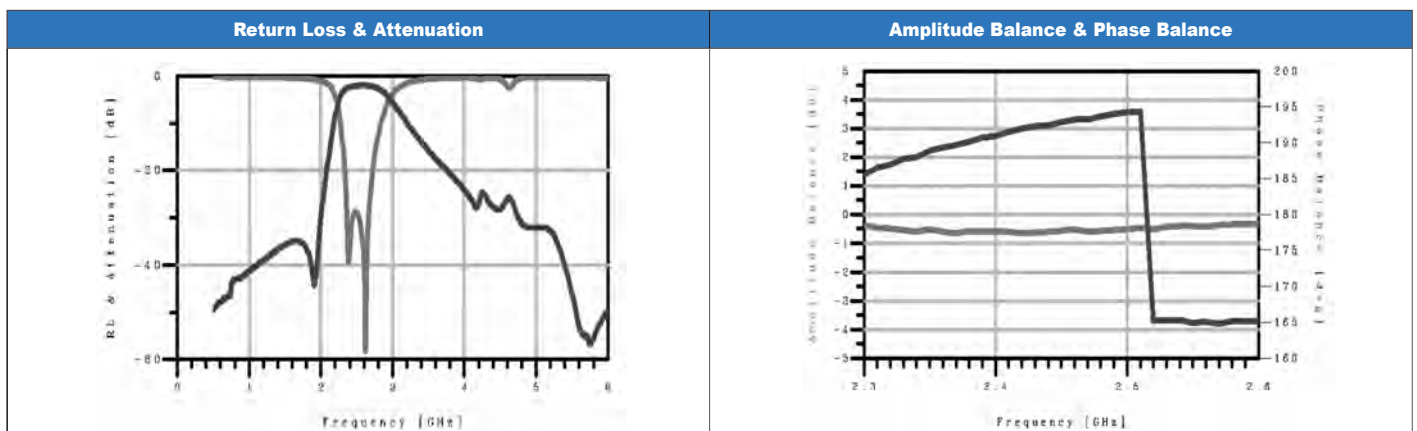

2.4 GHz High Frequency Devices-Balanced Filter-RFBPB2012110A5T

How to Order

| RF | BPB | 201211 | 0 | A | 5 | T |
|---------------|--|--|--------------------------|--------------------|----------------------|---|
| Walsin | Product code | Dimension code | Unit of dimension | Application | Specification | Packing |
| RF Device | BPB : Balanced Type Band Pass Filter | Per 2 digits of Length, Width, Thickness : e.g. : 201211 = Length 20, Width 12, Thickness 11 | 0: 0.1 mm 1: 1.0 mm | A: 2.4GHz ISM Band | Design Code | T=7" Reeled G=10" Reeled B=Bulk X: SFC product |

Dimensions

| Symbol | Dimension (mm) |
|--------|----------------|
| L | 2.00 ± 0.15 mm |
| W | 1.25 ± 0.10 mm |
| T | 1.10 ± 0.10 mm |
| a | 0.55 ± 0.10 mm |
| b | 0.20 ± 0.15 mm |
| c | 0.20 ± 0.15 mm |
| d | 0.30 ± 0.10 mm |
| e | 0.35 ± 0.10 mm |
| f | 0.65 ± 0.10 mm |

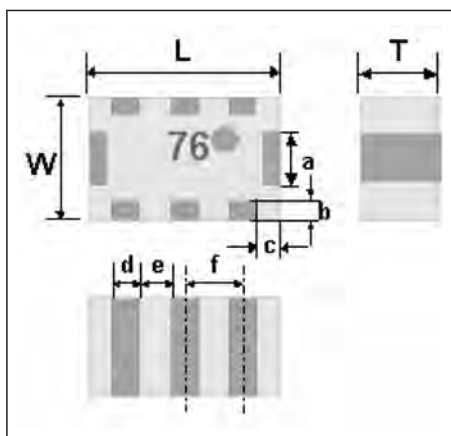

Pin Arrangement

| PIN | Definition | PIN | Definition |
|-----|-----------------|-----|---------------|
| P1 | Unbalanced Port | P5 | Balanced Port |
| P2 | DC or GND | P6 | GND |
| P3 | NC | P7 | Balanced Port |
| P4 | GND | P8 | GND |

RFBPB2012110A5T Series

| Item | Specification |
|------------------------|--|
| Frequency range | 2450 ± 50 MHz |
| Insertion Loss | 2.8 dB max |
| VSWR | 2.0 max |
| Impedance (Unbalanced) | 50 Ω |
| Impedance (Balanced) | Conjugate match to BC series of Bluetooth chipset |
| Phase Difference | 180° ± 10° |
| Amplitude Difference | 2.0 dB max |
| Attenuation (min.) | 30dB @880~960 MHz 30dB @1710~1880 MHz 20dB @1880~1990 MHz 30dB @4800~5000 MHz |

Typical Electrical Characteristics:

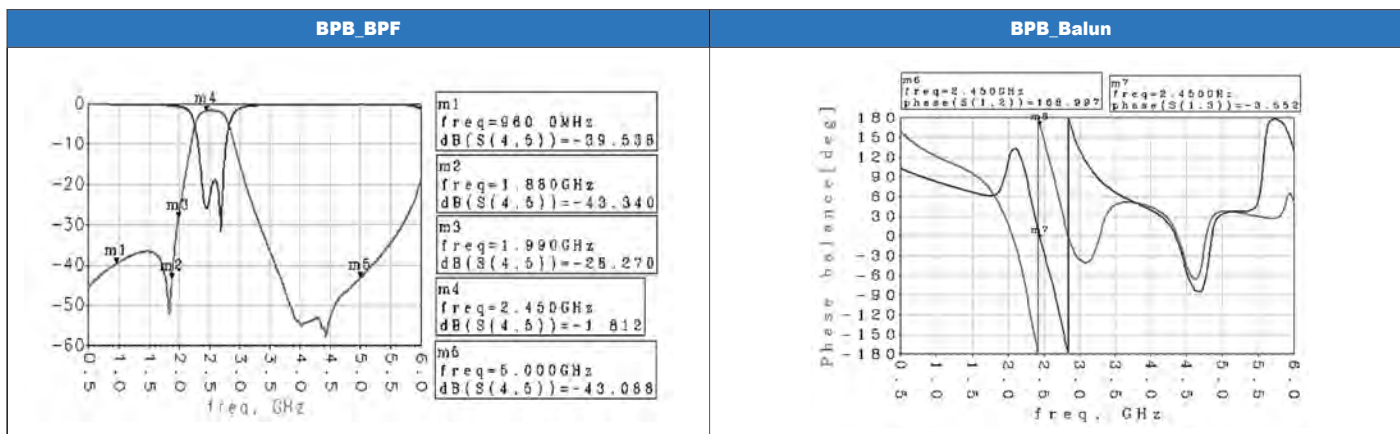

2.4 GHz High Frequency Devices-Balanced Filter-RFBPB2012100A□T

How to Order

| RF | BPB | 201210 | 0 | A | □ | T |
|---------------|--|--|--------------------------|--------------------|----------------------|---|
| Walsin | Product code | Dimension code | Unit of dimension | Application | Specification | Packing |
| RF Device | BPB : Balanced Type Band Pass Filter | Per 2 digits of Length, Width, Thickness : e.g. : 201210 = Length 20, Width 12, Thickness 10 | 0: 0.1 mm 1: 1.0 mm | A: 2.4GHz ISM Band | Design Code | T=7" Reeled G=10" Reeled B=Bulk X: SFC product |

Dimensions

| Symbol | Dimension (mm) |
|--------|----------------|
| L | 2.00 ± 0.15 mm |
| W | 1.25 ± 0.10 mm |
| T | 1.00 ± 0.10 mm |
| A | 0.20 ± 0.15 mm |
| B | 0.30 ± 0.10 mm |
| C | 0.35 ± 0.10 mm |
| D | 0.65 ± 0.10 mm |
| E | 0.20 ± 0.10 mm |
| F | 0.50 ± 0.10 mm |

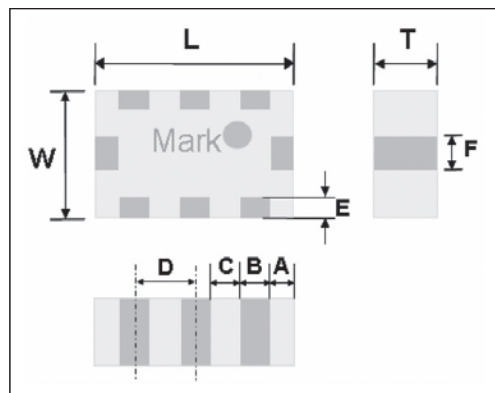

Pin Arrangement

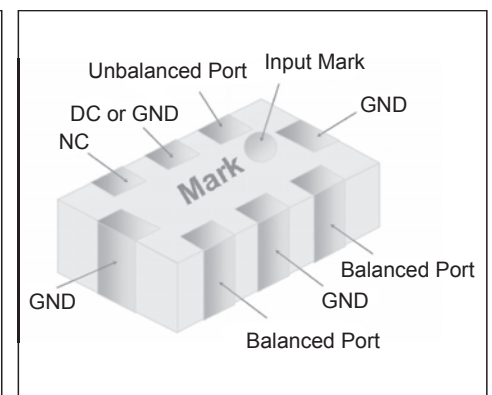

RFBPB2012100A□T Series

| Item | RFBPB2012100A1T | RFBPB2012100A6T |
|------------------------|--|---|
| Frequency range (MHz) | 2450 ± 50 | 2450 ± 50 |
| Insertion Loss (dB) | 3.5 max | 3.5 max |
| VSWR | 2.0 max | 2.0 max |
| Impedance (Unbalanced) | 50 Ω | 50 Ω |
| Impedance (Balanced) | Conjugate match to BC series of Bluetooth chipset | Conjugate match to BC series of Bluetooth chipset |
| Phase Difference | 180° ± 10° | 180° ± 10° |
| Amplitude Difference | 2 dB max | 2.0 dB max |
| Attenuation (dB min.) | 40 dB @880~960 MHz 35 dB @1710~1880 MHz 40 dB @1880~1900 MHz 35 dB @1900~1990 MHz 15 dB @2110~2170 MHz 30 dB @4800~5000 MHz | 35 dB @880~960 MHz 30 dB @1710~1880 MHz 20 dB @1880~1900 MHz 40 dB(Min) @4800~5000 MHz |

Type Electrical Characteristics (RFBPB2012100A6T):

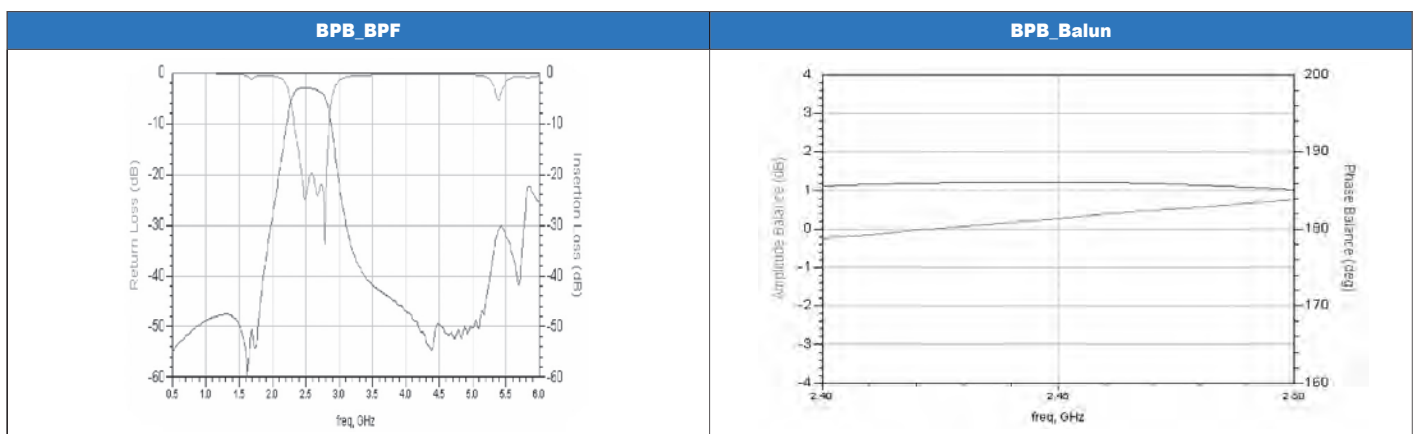

2.4 GHz High Frequency Devices-Balanced Filter - RFBPB2012090A□T

How to Order

| RF | BPB | 201209 | 0 | A | □ | T |
|----------------------------|---|---|--|--|-------------------------------------|---|
| Walsin RF Device | Product code BPB : Balanced Type Band Pass Filter | Dimension code Per 2 digits of Length, Width, Thickness : e.g. : 201209 = Length20, Width 12, Thickness 9 | Unit of dimension 0: 0.1 mm 1: 1.0 mm | Application A: 2.4GHz ISM Band | Specification Design Code | Packing T=7" Reeled G=10" Reeled B=Bulk X: SFC product |

Dimensions

| Symbol | Dimension (mm) |
|--------|----------------|
| L | 2.00 ± 0.15 |
| W | 1.25 ± 0.10 |
| T | 0.90 ± 0.10 |
| a | 0.30 ± 0.10 |
| b | 0.20 ± 0.15 |
| c | 0.20 ± 0.15 |
| d | 0.35 ± 0.10 |
| e | 0.65 ± 0.10 |

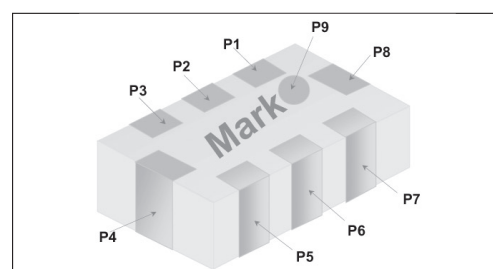
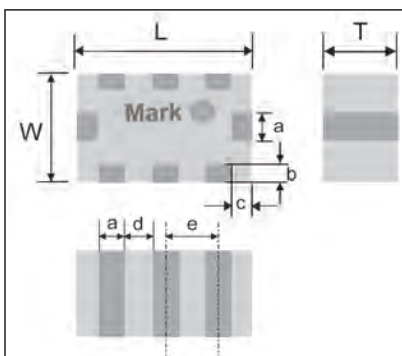

| PIN | Definition | PIN | Definition |
|-----|-----------------|-----|---------------|
| P1 | Unbalanced Port | P5 | Balanced Port |
| P2 | DC or GND | P6 | GND |
| P3 | NC | P7 | Balanced Port |
| P4 | GND | P8 | GND |

RFBPB2012090A□T Series

| Item | RFBPB2012090A1T (Mark:41) | RFBPB2012090A3T (Mark:97) | RFBPB2012090A9T (Mark:93) |
|------------------------|--|--|--|
| Frequency range (MHz) | 2450 ± 50 | 2450 ± 50 | 2450 ± 50 |
| Insertion Loss (dB) | 3.5 dB max | 3.5 dB max | 2.8 dB max |
| VSWR | 2.1 max | 2.1 max | 2.1 max |
| Impedance (Unbalanced) | 50 Ω | 50 Ω | 50 Ω |
| Impedance (Balanced) | Conjugate match to BC series of Bluetooth chipset | Conjugate match to BC series of Bluetooth chipset | Conjugate match to BC series of Bluetooth chipset |
| Phase Difference | 180° ± 10° | 180° ± 10° | 180° ± 10° |
| Amplitude Difference | 2.0 dB max | 2.0 dB max | 2.0 dB max |
| Attenuation (dB min.) | 35dB @ 880~960 MHz 30dB @ 1710~1880 MHz 20dB @ 1880~1990 MHz 30dB @ 4800~5000 MHz | 35dB @ 880~960 MHz 30dB @ 1710~1880 MHz 20dB @ 1880~1990 MHz 30dB @ 4800~5000 MHz | 35dB @ 880~960 MHz 25dB @ 1710~1880 MHz 30dB @ 4800~5000 MHz |

Typical Electrical Characteristics:

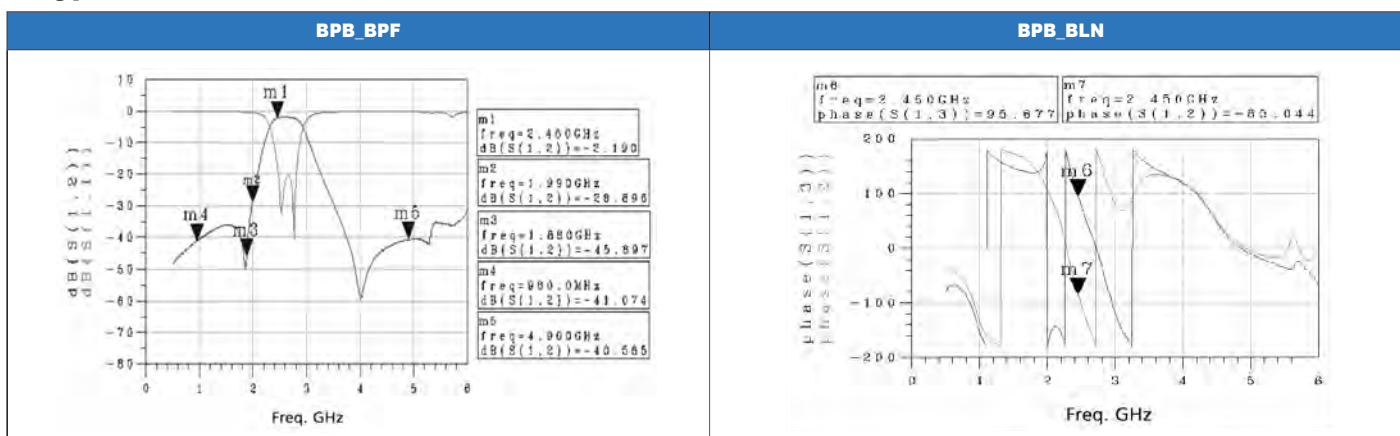

2.4 GHz High Frequency Devices-Balanced Filter-RFBPB2012060A1T

How to Order

| RF | BPB | 201206 | 0 | A | 1 | T |
|---------------|--|--|--------------------------|--------------------|----------------------|---|
| Walsin | Product code | Dimension code | Unit of dimension | Application | Specification | Packing |
| RF Device | BPB : Balanced Type Band Pass Filter | Per 2 digits of Length, Width, Thickness : e.g. : 201206 = Length 20, Width 12, Thickness 06 | 0: 0.1 mm 1: 1.0 mm | A: 2.4GHz ISM Band | Design Code | T=7" Reeled G=10" Reeled B=Bulk X: SFC product |

Dimensions

| Symbol | Dimension (mm) |
|--------|----------------|
| L | 2.00 ± 0.15 mm |
| W | 1.25 ± 0.10 mm |
| T | 0.60 ± 0.10 mm |
| A | 0.20 ± 0.15 mm |
| B | 0.30 ± 0.10 mm |
| C | 0.35 ± 0.10 mm |
| D | 0.65 ± 0.10 mm |
| E | 0.20 ± 0.10 mm |
| F | 0.50 ± 0.10 mm |

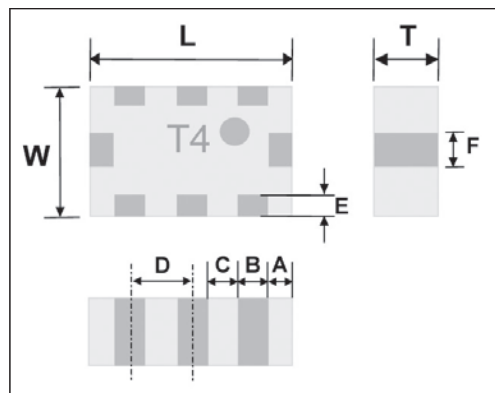

Pin Arrangement

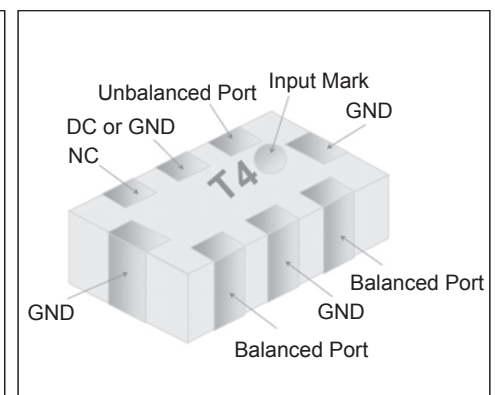

RFBPB2012060A1T Series

| Item | Specification |
|------------------------|--|
| Frequency range (MHz) | 2450 ± 50 |
| Insertion Loss (dB) | 3.5 max |
| VSWR | 2.0 max |
| Impedance (Unbalanced) | 50 Ω |
| Impedance (Balanced) | Conjugate match to BC series of CSR |
| Phase Difference | 180° ± 10° |
| Amplitude Difference | 2 dB max |
| Attenuation (dB min.) | 35 dB @880~960 MHz 30 dB @1710~1880 MHz 25 dB @1880~1900 MHz 20 dB @1900~1990 MHz 30 dB @4800~5000 MHz |

Type Electrical Characteristics:

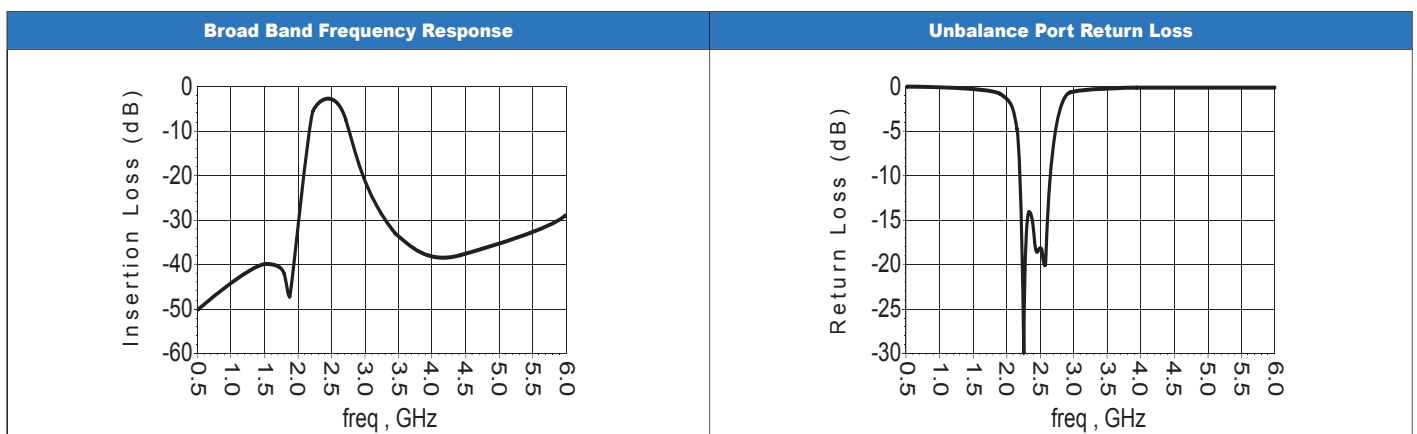

2.4 GHz High Frequency Devices-Low Pass Filter-RFLPF2012110A0T

How to Order

| RF | LPF | 201211 | 0 | A | 0 | T |
|---------------|-----------------------|---|--------------------------|--------------------|----------------------|---|
| Walsin | Product code | Dimension code | Unit of dimension | Application | Specification | Packing |
| RF Device | LPF : Low Pass Filter | 201211 = Length = 20, Width = 12, Thickness = 11 | 0: 0.1 mm 1: 1.0 mm | A: 2.4GHz ISM Band | Design Code | T=7" Reeled G=10" Reeled B=Bulk X: SFC product |

Dimensions

| Symbol | Dimension |
|--------|----------------|
| L | 2.00 ± 0.15 mm |
| W | 1.25 ± 0.10 mm |
| T | 1.05 ± 0.10 mm |
| A | 0.30 ± 0.10 mm |
| B | 0.30 ± 0.10 mm |
| C | 0.30 ± 0.10 mm |
| D | 0.40 ± 0.20 mm |
| E | 0.30 ± 0.10 mm |
| F | 0.20 ± 0.10 mm |
| P | 0.65 ± 0.10 mm |

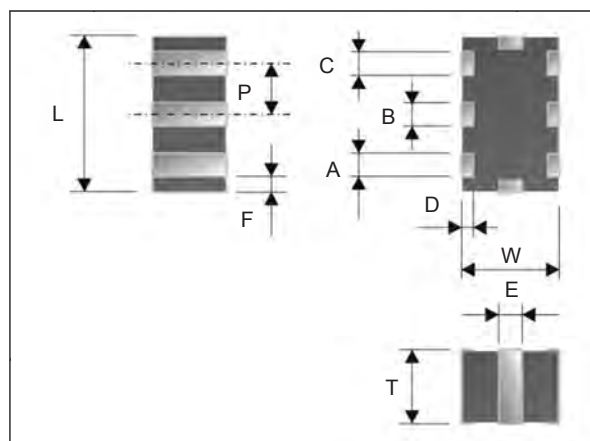

RFLPF2012110A0T Series

| Item | Specification |
|-----------------------|--|
| Frequency range (MHz) | 2450 ± 50 |
| Insertion Loss (dB) | 0.7 (max) |
| VSWR | 1.5 |
| Attenuation (dB min.) | 30 @ 2 x (fo ± BW/2) 25 @ 3 x (fo ± BW/2) |

Typical Electrical Characteristics:

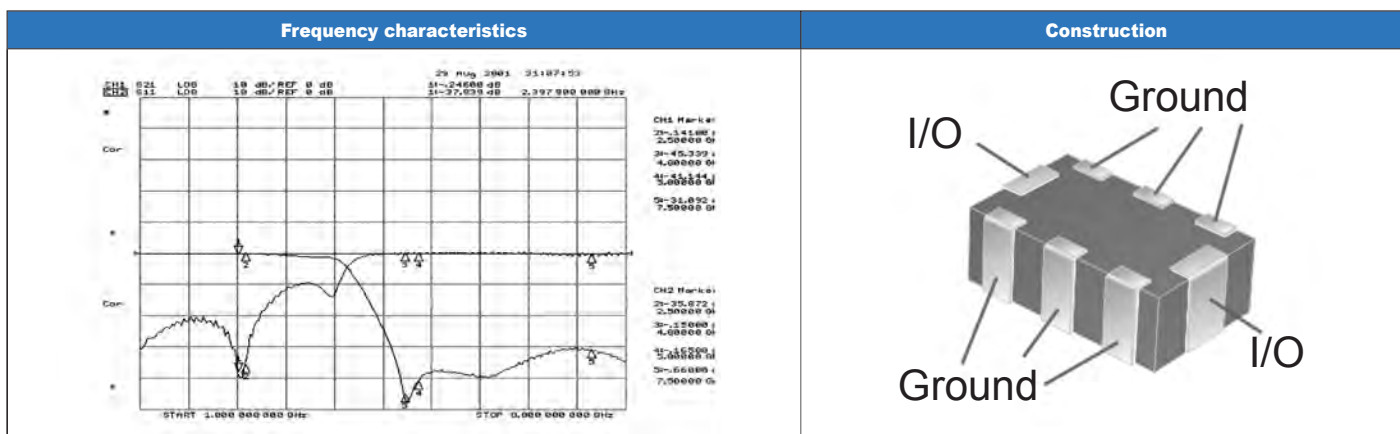

2.4 GHz High Frequency Devices-Balun-RFBLN2012090A□T

How to Order

| RF | BLN | 201209 | 0 | A | □ | T |
|----------------------------|------------------------------------|--|--|--|-------------------------------------|---|
| Walsin RF Device | Product code BLN : BALUN | Dimension code 201209 = Length = 20, Width = 12, Thickness = 09 | Unit of dimension 0: 0.1 mm 1: 1.0 mm | Application A: 2.4GHz ISM Band | Specification Design Code | Packing T=7" Reeled G=13" Reeled B=Bulk X: SFC product |

Dimensions

| Symbol | Dimension | Terminals | Connection |
|--------|----------------|-----------|-------------------|
| L | 2.00 ± 0.15 mm | 1 | Unbalanced port |
| W | 1.25 ± 0.15 mm | 2 | Ground or DC feed |
| t | 0.95 ± 0.10 mm | 3 | Balanced port |
| a | 0.20 ± 0.20 mm | 4 | Balanced port |
| b | 0.30 ± 0.20 mm | 5 | Ground |
| c | 0.35 ± 0.20 mm | 6 | Non Connection |
| d | 0.65 ± 0.20 mm | - | - |

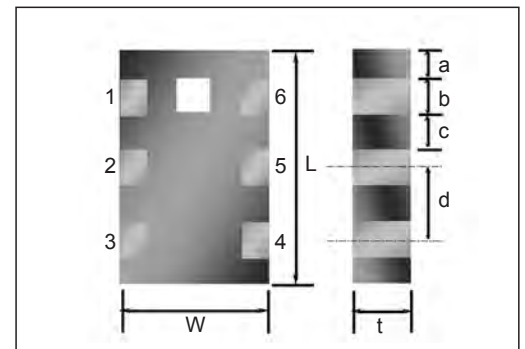

RFBLN2012090A□T Series

| Part Number. | Frequency(MHz) | Impedance (Ω) | | Return Loss (dB) Min. | Inband Amplitude imbalance (dB) Max. | Inband Phase imbalance (degree) | Insertion Loss (dB) |
|-----------------|----------------|---------------|----------|-----------------------|--------------------------------------|---------------------------------|---------------------|
| | | Unbalanced | Balanced | | | | |
| RFBLN2012090A0T | 2450 ± 50 | 50 | 50 | 10 | 2.0 | 180 ± 10 | 1.2 |
| RFBLN2012090A1T | 2450 ± 50 | 50 | 100 | 10 | 2.0 | 180 ± 10 | 1.0 |
| RFBLN2012090A2T | 2450 ± 50 | 50 | 200 | 10 | 2.0 | 180 ± 10 | 1.0 |

Typical Electrical Characteristics (RFBLN2012090A1T):

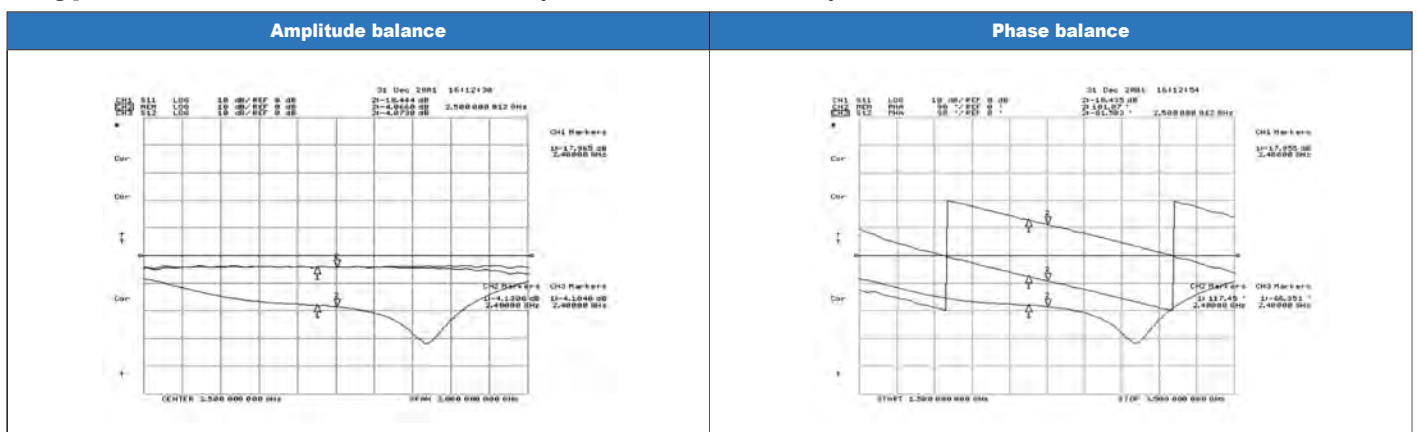

2.4 GHz High Frequency Devices-Balun-RGBLN2012080A4T

How to Order

| RG | BLN | 201208 | 0 | A | 4 | T |
|---|------------------------------------|--|--|--|-------------------------------------|---|
| Walsin RG: RF /Pb free device | Product code BLN : BALUN | Dimension code Per 2 digits of Length, Width, Thickness : e.g. : 201208 = Length20, Width 12, Thickness 08 | Unit of dimension 0: 0.1 mm 1: 1.0 mm | Application A: 2.4GHz ISM Band | Specification Design Code | Packing T=7" Reeled G=13" Reeled B=Bulk X: SFC product |

Dimensions

| Symbol | Dimension | Terminals | Connection |
|--------|----------------|-----------|-------------------|
| L | 2.00 ± 0.15 mm | 1 | Unbalanced port |
| W | 1.25 ± 0.15 mm | 2 | Ground or DC feed |
| T | 0.80 ± 0.10 mm | 3 | Balanced port |
| A | 0.20 ± 0.20 mm | 4 | Balanced port |
| B | 0.30 ± 0.20 mm | 5 | Ground |
| C | 0.35 ± 0.20 mm | 6 | Non Connection |
| D | 0.65 ± 0.20 mm | - | - |

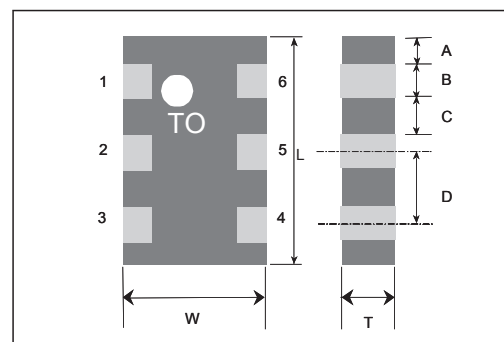

RGLN2012080A4T Series

| Part Number. | Frequency(MHz) | Impedance (Ω) | | Return Loss (dB) Min. | Inband Amplitude imbalance (dB) Max. | Inband Phase imbalance (degree) | Insertion Loss (dB) |
|----------------|----------------|---------------|----------|-----------------------|--------------------------------------|---------------------------------|---------------------|
| | | Unbalanced | Balanced | | | | |
| RGLN2012080A4T | 2450 ± 50 | 50 | 50 | 10 | 2.0 | 180 ± 10 | 1.5 |

Typical Electrical Characteristics:

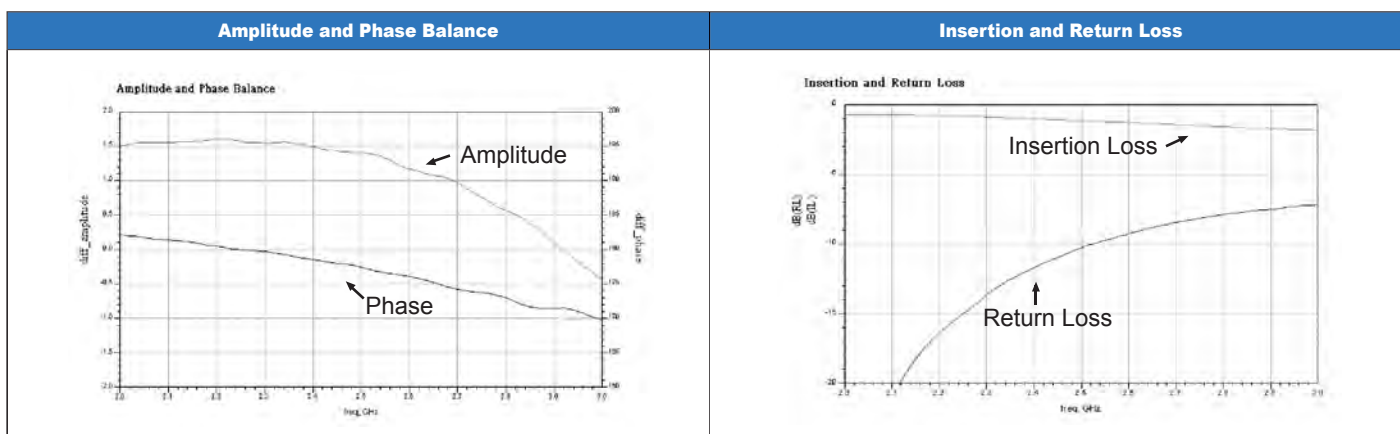

2.4 GHz High Frequency Devices-Balun-RGBLN1608070A1T

How to Order

| RG | BLN | 160807 | 0 | A | 1 | T |
|---|------------------------------------|--|--|--|-------------------------------------|---|
| Walsin RG: RF /Pb free device | Product code BLN : BALUN | Dimension code Per 2 digits of Length, Width, Thickness : e.g. : 160807 = Length16, Width 08, Thickness 07 | Unit of dimension 0: 0.1 mm 1: 1.0 mm | Application A: 2.4GHz ISM Band | Specification Design Code | Packing T=7" Reeled G=13" Reeled B=Bulk X: SFC product |

Dimensions

| Symbol | Dimension |
|--------|----------------|
| L | 1.60 ± 0.10 mm |
| W | 0.85 ± 0.10 mm |
| T | 0.7 ± 0.10 mm |
| E | 0.15 ± 0.10 mm |
| A | 0.20 ± 0.10 mm |
| B | 0.20 ± 0.10 mm |
| C | 0.30 ± 0.10 mm |
| D | 0.50 ± 0.05 mm |

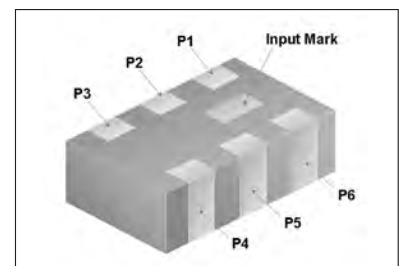
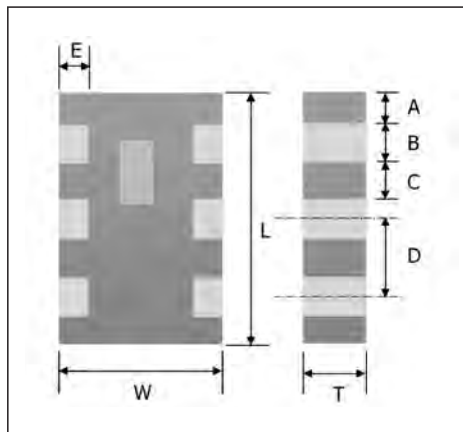

| PIN | Connection |
|-----|-----------------|
| P1 | Unbalanced Port |
| P2 | Non Connection |
| P3 | Ground |
| P4 | Balanced port |
| P5 | Non Connection |
| P6 | Balanced port |

RGBLN1608070A1T Series

| Part Nr. | Frequency(MHz) | Impedance (Ω) | | Return Loss (dB) Min. | Inband Amplitude imbalance (dB) Max. | Inband Phase imbalance (degree) | Insertion Loss (dB) |
|-----------------|----------------|---------------|----------|-----------------------|--------------------------------------|---------------------------------|---------------------|
| | | Unbalanced | Balanced | | | | |
| RGBLN1608070A1T | 2450 ± 50 | 50 | 100 | 10 | 2.0 | 180 ± 15 | 1.5 |

Typical Electrical Characteristics:

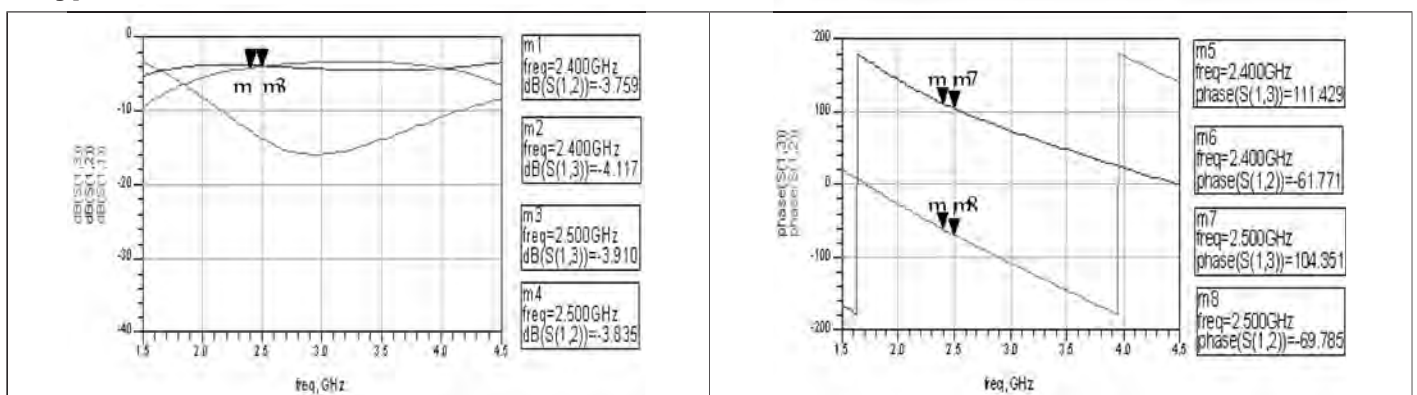

2.4 GHz High Frequency Devices-Balun-RGBLN1608070A5T

How to Order

| RG | BLN | 160807 | 0 | A | 5 | T |
|---|------------------------------------|--|--|--|-------------------------------------|---|
| Walsin RG: RF /Pb free device | Product code BLN : BALUN | Dimension code Per 2 digits of Length, Width, Thickness : e.g. : 160807 = Length16, Width 08, Thickness 07 | Unit of dimension 0: 0.1 mm 1: 1.0 mm | Application A: 2.4GHz ISM Band | Specification Design Code | Packing T=7" Reeled G=13" Reeled B=Bulk X: SFC product |

Dimensions

| Symbol | Dimension |
|--------|----------------|
| L | 1.60 ± 0.10 mm |
| W | 0.85 ± 0.10 mm |
| T | 0.70 ± 0.10 mm |
| E | 0.15 ± 0.10 mm |
| A | 0.15 ± 0.10 mm |
| B | 0.25 ± 0.10 mm |
| C | 0.25 ± 0.10 mm |
| D | 0.50 ± 0.05 mm |

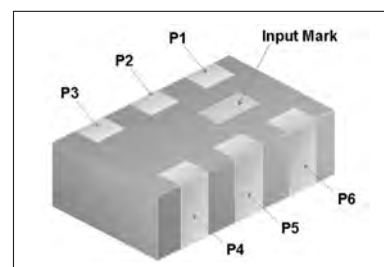
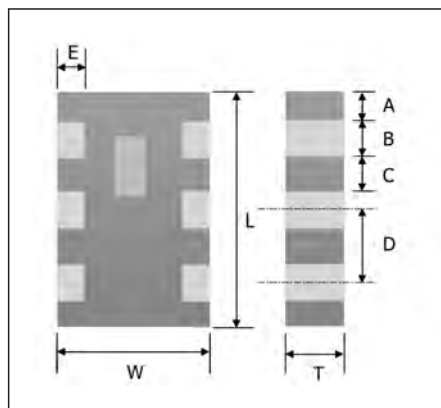

| PIN | Connection |
|-----|-----------------|
| P1 | Unbalanced Port |
| P2 | DC or GND |
| P3 | Balanced port |
| P4 | Balanced port |
| P5 | GND |
| P6 | NC |

RGBLN1608070A5T Series

| Part Nr. | Frequency(MHz) | Impedance (Ω) | | Return Loss (dB) Min. | Inband Amplitude imbalance (dB) Max. | Inband Phase imbalance (degree) | Insertion Loss (dB) |
|-----------------|----------------|---------------|----------|-----------------------|--------------------------------------|---------------------------------|---------------------|
| | | Unbalanced | Balanced | | | | |
| RGBLN1608070A5T | 2450 ± 50 | 50 | 100 | 10 | 2.0 | 180 ± 10 | 1.2 |

Typical Electrical Characteristics:

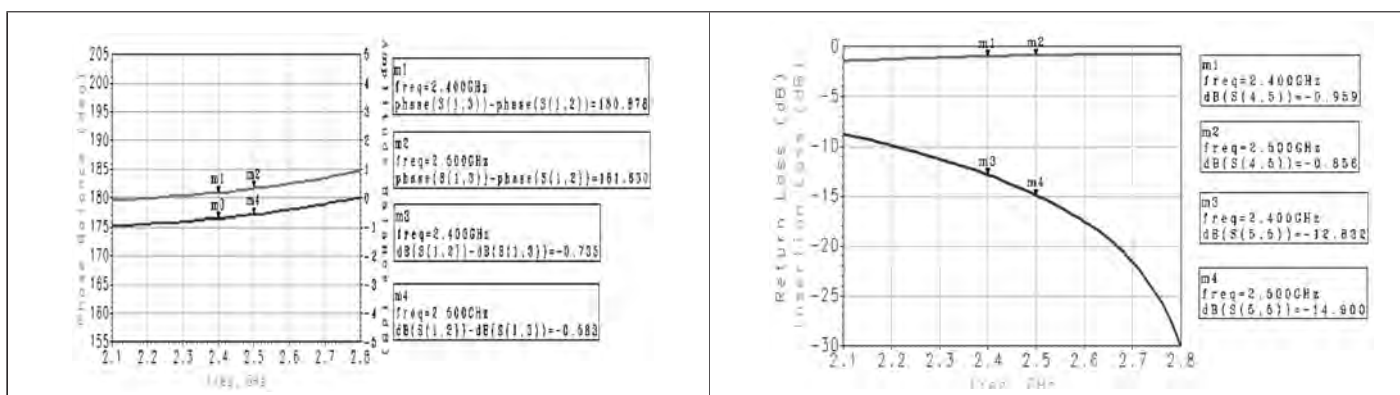

■ 2.4/4.9/5.2/5.8 GHz WLAN IEEE802.11 a/b/g Combo-Chip Antenna-RFANT6050110L□T

■ How to Order

| RF | ANT | 605011 | 0 | L | □ | T |
|----------------------------|-------------------------------------|--|--|---|-------------------------------------|---|
| Walsin RF device | Product code ANT: Antenna | Dimension code Per 2 digits of Length, Width, Thickness : e.g. : 605011 = Length60, Width 50, Thickness 11 | Unit of dimension 0: 0.1 mm 1: 1.0 mm | Application L: 2.4/4.9/5.8 GHz Multiband Application | Specification Design Code | Packing T=7" Reeled G=13" Reeled B=Bulk X: SFC product |

■ Dimensions

| RFANT6050110L0T | | | RFANT6050110L1T | | |
|-----------------|---------------|-----------------|-----------------|--------------|--------------------|
| | | | | | |
| Symbol | Dimension | Port Definition | Symbol | Dimension | Port Definition |
| L | 5.9 ± 0.3 mm | --- | c | 1.0 ± 0.2 mm | --- |
| W | 5.1 ± 0.3 mm | --- | d | 2.0 ± 0.2 mm | --- |
| T | 1.1 ± 0.1 mm | --- | 1 | 1.0 ± 0.2 mm | 50 Ω RF Feeding |
| a | 0.45 ± 0.2 mm | --- | 2 | 1.0 ± 0.2 mm | Ground Termination |
| b | 1.0 ± 0.2 mm | --- | 3 | 1.0 ± 0.2 mm | Solder Termination |

■ RFANT6050110L□T Series

| Item | Specification | | |
|---------------------|------------------|----------|----------|
| Central Frequency | 2.45 GHz | 5.25 GHz | 5.85 GHz |
| Gain (Typical) | 1.5 dBi | 4 dBi | 4 dBi |
| Bandwidth (Typical) | 100 MHz | 200 MHz | 100 MHz |
| VSWR | 2 Max. | | |
| Polarization | Linear | | |
| Azimuth Bandwidth | Omni-directional | | |
| Impedance | 50 Ω | | |

■ Typical Electrical Characteristics:

| RFANT6050110L0T (Right side) | | 2.45GHz | 5.80GHz |
|------------------------------|-------------------|---|---|
| | E-Plane | <p>Peak Gain = +4.74 dBi Average Gain = -1.46 dBi</p> | <p>Peak Gain = +4.99 dBi Average Gain = -1.31 dBi</p> |
| | Return Loss (S11) | | <p>Peak Gain = +0.48 dBi Average Gain = -4.59 dBi</p> |
| RFANT6050110L1T (Left side) | | 2.45GHz | 5.80GHz |
| | E-Plane | <p>Peak Gain = +3.82 dBi Average Gain = -1.19 dBi</p> | <p>Peak Gain = +4.81 dBi Average Gain = -1.42 dBi</p> |
| | Return Loss (S11) | | <p>Peak Gain = +0.16 dBi Average Gain = -4.33 dBi</p> |

■ 2.4/4.9/5.2/5.8 GHz High Frequency Devices-Diplexer-RFDIP2012100L□T

■ How to Order

| RF | DIP | 201210 | 0 | L | □ | T |
|----------------------------|---------------------------------------|--|--|---|-------------------------------------|---|
| Walsin RF Device | Product code DIP : Diplexer | Dimension code 201210 = Length = 20 Width = 12 Thickness = 10 | Unit of dimension 0: 0.1 mm 1: 1.0 mm | Application L: 2.4/ 4.9/ 5.2/ 5.8GHz Multiband Application | Specification Design Code | Packing T=7" Reeled G=10" Reeled B=Bulk X: SFC product |

■ Dimensions

| Symbol | Dimension |
|--------|----------------|
| L | 2.00 ± 0.15 mm |
| W | 1.25 ± 0.15 mm |
| T | 0.95 ± 0.10 mm |
| a | 0.20 ± 0.20 mm |
| b | 0.30 ± 0.20 mm |
| c | 0.35 ± 0.20 mm |
| d | 0.65 ± 0.20 mm |
| e | 0.30 ± 0.20 mm |
| f | 0.25 ± 0.20 mm |

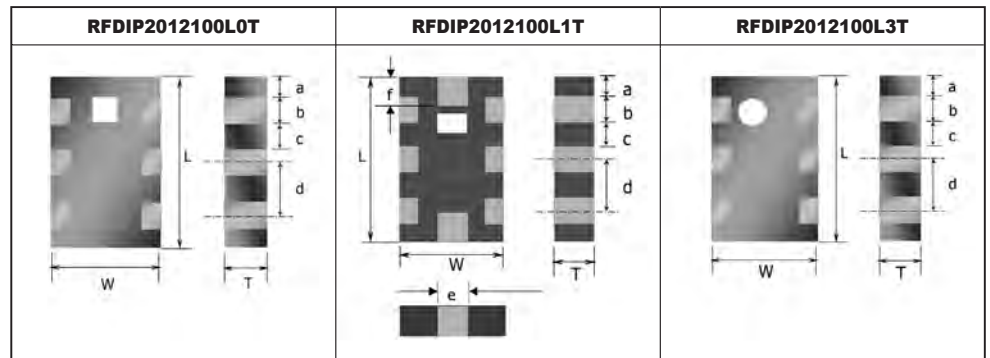

■ RFDIP2012100L□T Series

| Item | RFDIP2012100L0T | | RFDIP2012100L1T | | RFDIP2012100L3T | |
|-------------------|--|-------------------|--|-------------------|--|-------------------|
| | Band 1 | Band 2 | Band 1 | Band 2 | Band 1 | Band 2 |
| Central Frequency | 2450 ± 50 MHz | 5400 ± 500 MHz | 2450 ± 50 MHz | 5400 ± 500 MHz | 2450 ± 50 MHz | 5400 ± 500 MHz |
| Impedance | 50 Ω | 50 Ω | 50 Ω | 50 Ω | 50 Ω | 50 Ω |
| insertion Loss | 0.7 dB | 0.9 dB | 0.7 dB | 0.9 dB | 0.7 dB | 0.9 dB |
| Return Loss | Min.10 dB | | Min.10 dB | | Min.10 dB | |
| Attenuation | -20 dB @ 4.9 GHz -25 dB @ 5.2 GHz -25 dB @ 5.8 GHz | -25 dB @ 2.45 GHz | -20 dB @ 4.9 GHz -20 dB @ 5.2 GHz -20 dB @ 5.8 GHz | -20 dB @ 2.45 GHz | -20 dB @ 4.9 GHz -25 dB @ 5.2 GHz -25 dB @ 5.8 GHz | -25 dB @ 2.45 GHz |
| Ripple | 0.5 dB | | 0.5 dB | | 0.5 dB | |

■ Typical Electrical Characteristics:

| RFDIP2012100L0T | RFDIP2012100L1T | RFDIP2012100L3T |
|--------------------------------------|--------------------------------------|--------------------------------------|
| | | |
| Frequency Characteristics | Frequency Characteristics | Frequency Characteristics |

4.9/ 5.2/ 5.8 GHz High Frequency Devices-Balun-RFBLN2012090K□T

How to Order

| RF | BLN | 201209 | 0 | K | □ | T |
|----------------------------|------------------------------------|--|--|--|-------------------------------------|---|
| Walsin RF Device | Product code BLN : BALUN | Dimension code 201209 = Length = 20 Width = 12 Thickness = 09 | Unit of dimension 0: 0.1 mm 1: 1.0 mm | Application K: ISM 5.2/5.8 GHz Dualband Application | Specification Design Code | Packing T=7" Reeled G=13" Reeled B=Bulk X: SFC product |

Dimensions

| Symbol | Dimension | Terminals | Connection |
|--------|----------------|-----------|-------------------|
| L | 2.00 ± 0.15 mm | 1 | Unbalanced port |
| W | 1.25 ± 0.15 mm | 2 | Ground or DC feed |
| t | 0.95 ± 0.10 mm | 3 | Balanced port |
| a | 0.20 ± 0.20 mm | 4 | Balanced port |
| b | 0.30 ± 0.20 mm | 5 | Ground |
| c | 0.35 ± 0.20 mm | 6 | Non Connection |
| d | 0.65 ± 0.20 mm | | |
| f | 0.30 ± 0.20 mm | | |

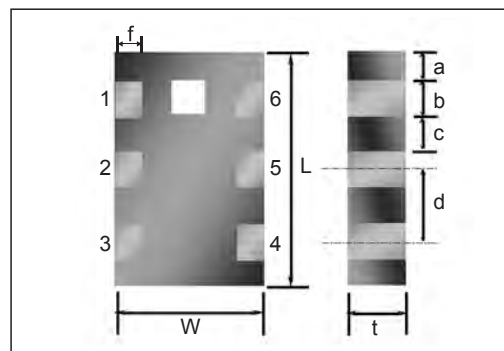

RFBLN2012090K□T Series

| Part Number. | Frequency(MHz) | Impedance (Ω) | | Return Loss (dB) Min. | Inband Amplitude imbalance (dB) Max. | Inband Phase imbalance (degree) | Insertion Loss (dB) |
|-----------------|----------------|---------------|----------|-----------------------|--------------------------------------|---------------------------------|---------------------|
| | | Unbalanced | Balanced | | | | |
| RFBLN2012090K0T | 5400 ± 500 | 50 | 50 | -10 | 2.0 | 180° ± 10° | -1.1 |
| RFBLN2012090K1T | 5400 ± 500 | 50 | 100 | -10 | 2.0 | 180° ± 10° | -1.2 |

Typical Electrical Characteristics (RFBLN2012090K1T):

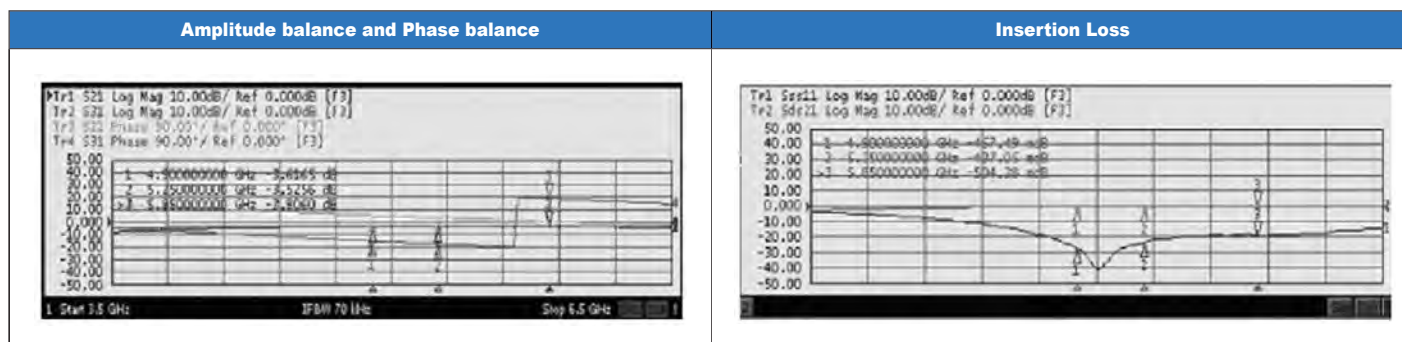

■ 4.9/ 5.2/ 5.8 GHz High Frequency Devices-Band Pass Filter-RFBPF2012100K0T

■ How to Order

| RF | BPF | 201210 | 0 | K | 0 | T |
|---------------|------------------------|---|--------------------------|--|----------------------|---|
| Walsin | Product code | Dimension code | Unit of dimension | Application | Specification | Packing |
| RF Device | BPF : Band Pass Filter | 201210 = Length = 20 Width = 12 Thickness = 10 | 0: 0.1 mm 1: 1.0 mm | K: ISM 5.2/5.8 GHz Dualband Application | Design Code | T=7" Reeled G=10" Reeled B=Bulk X: SFC product |

■ Dimensions

| Symbol | Dimension |
|--------|----------------|
| L | 2.00 ± 0.15 mm |
| W | 1.25 ± 0.15 mm |
| T | 0.95 ± 0.10 mm |
| A | 0.25 ± 0.15 mm |
| B | 0.25 ± 0.10 mm |
| C | 0.25 ± 0.10 mm |
| D | 0.25 ± 0.15 mm |
| E | 1.00 ± 0.15 mm |

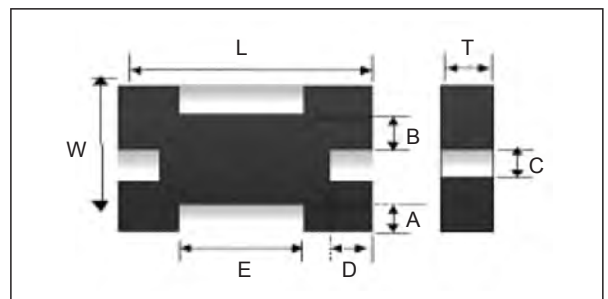

■ RFBPF2012100K0T Series

| Item | Specification |
|---------------------|---|
| Central Frequency | 5400 ± 500 MHz |
| Insertion Loss (dB) | -1.7 dBi @ 4.90 GHz -1.5 dBi @ 5.25 GHz -1.5 dBi @ 5.85 GHz |
| VSWR | 2.0 Max. |
| Ripple | 0.6 dB |
| Attenuation (Min.) | -30 dBi @ 3450 MHz -20 dBi @ 11000 MHz |

■ Typical Electrical Characteristics:

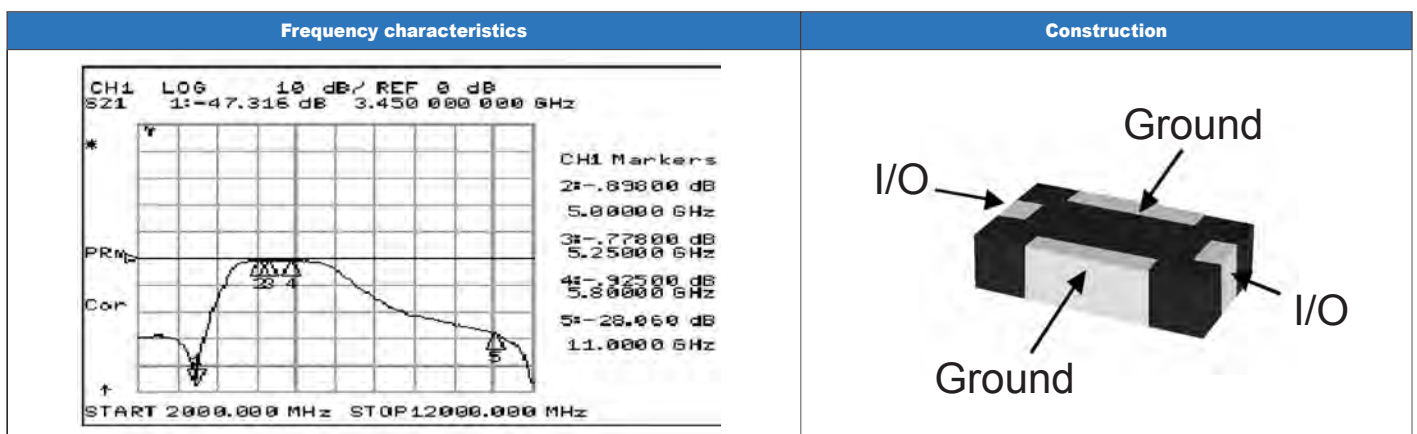

■ LTCC EMI Filter Array (4 Channel EMI Filter Array) - RGEMA2012080B□T

■ How to Order

| RG | EMA | 201208 | 0 | B | □ | T |
|--|---|---|--|-----------------------------------|-------------------------------------|---|
| Walsin RG: RF/Pb free device | Product code EMI filter array | Dimension code Per 2 digits of Length, Width, Thickness : e.g. : 201208 = Length20, Width 12, Thickness 8 | Unit of dimension 0: 0.1 mm 1: 1.0 mm | Application B: GSM Band | Specification Design Code | Packing T=7" Reeled G=10" Reeled B=Bulk X: SFC product |

■ Dimensions

| Symbol | Dimension (mm) |
|--------|----------------|
| L | 2.00 ± 0.10 |
| W | 1.20 ± 0.05 |
| T | 0.80 ± 0.10 |
| a | 0.25 ± 0.05 |
| b | 0.40 ± 0.05 |
| c | 0.10 ± 0.05 |
| d | 0.25 ± 0.05 |
| e | 0.20 ± 0.05 |

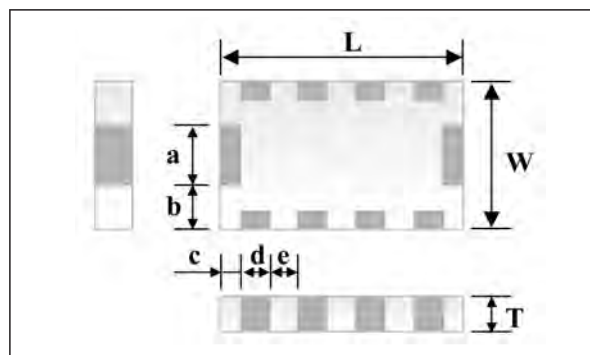

■ RGEMA2012080B□T Series

| Item | RGEMA2012080B4T | RGEMA2012080B5T | RGEMA2012080B6T |
|-------------------------------|---------------------|---------------------|---------------------|
| Attenuation (min) | 20dB @ 800~2500 MHz | 20dB @ 800~2500 MHz | 20dB @ 800~2500 MHz |
| -3dB Cut-Off Frequency | 400MHz +/-15% | 500MHz +/-15% | 600MHz +/-15% |
| Rated Current | 100 mA | 100 mA | 100 mA |
| Isolation | 20dB | 20dB | 20dB |
| Capacitance @ 1MHz(Reference) | 25 pF +/-20% | 25 pF +/-20% | 22 pF +/-20% |
| ESD surge capability (KV) | >15 | >15 | >15 |

■ Typical Electrical Characteristics:

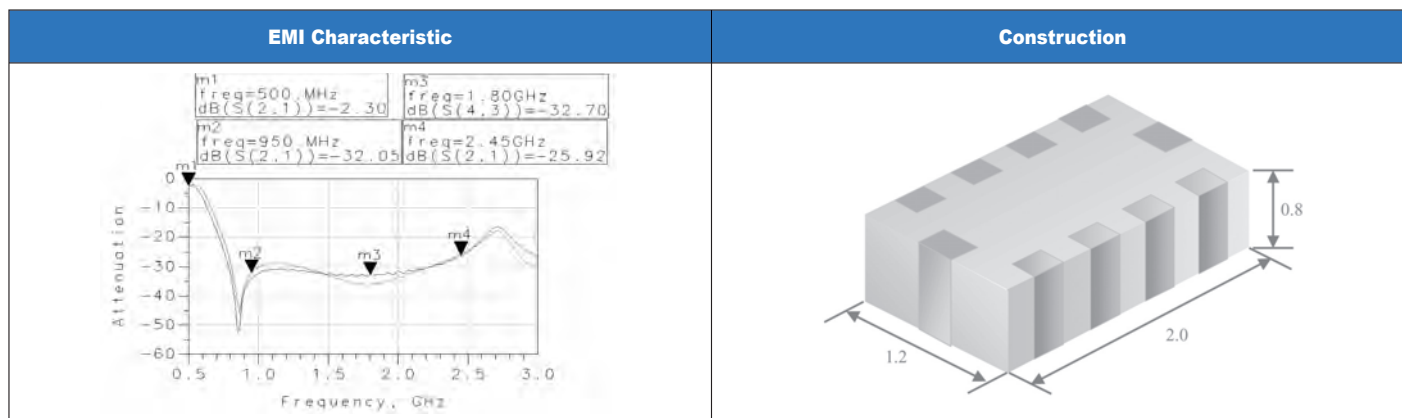

■ LTCC EMI Filter Array (4 Channel EMI Filter Array) - RFLVA2012080B□T

■ How to Order

| RG | LVA | 201208 | 0 | B | □ | T |
|---------------|---------------------|--|--------------------------|--------------------|----------------------|---|
| Walsin | Product code | Dimension code | Unit of dimension | Application | Specification | Packing |
| RF Device | EMI filter array | Per 2 digits of Length, Width, Thickness : e.g. : 201208 = Length20, Width 12, Thickness 8 | 0: 0.1 mm 1: 1.0 mm | B: GSM Band | Design Code | T=7" Reeled G=10" Reeled B=Bulk X: SFC product |

■ Dimensions

| Symbol | Dimension (mm) |
|--------|----------------|
| L | 2.00 ± 0.10 |
| W | 1.20 ± 0.10 |
| T | 0.80 ± 0.10 |
| a | 0.13 ± 0.10 |
| b | 0.24 ± 0.12 |
| c | 0.26 ± 0.12 |
| d | 0.50 ± 0.12 |
| e | 0.27 ± 0.10 |
| f | 0.20 ± 0.15 |
| g | 0.20 ± 0.15 |

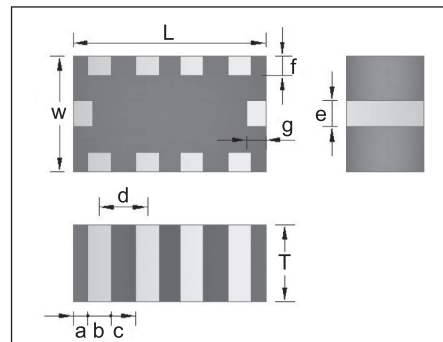

■ EMI Specification

| Item | Specification |
|-------------------------------|---------------------------------|
| Attenuation (min) | 20dB @900 MHz 20dB @2000 MHz |
| Cut-Off Frequency (Typical) | 120/ 220MHz ± 30% |
| Rated Current | 100 mA |
| Operating Temperature | -40 ~ +85 deg. c |
| Capacitance @1MHz (Reference) | 40/ 30 pF ± 20% |
| DC Resistance (Reference) | 5.0 ohm ± 20% |

■ ESD Specification

| Max. Continuous Working Voltage | Max. Clamping Voltage at Specified Current (8/20 us) | Varistor Voltage At 1mA (DC) current | |
|---------------------------------|--|--------------------------------------|------|
| V _{M(DC)} | V _c at 1A | Min. | Max. |
| 5V | 85V | 30V | 55V |

■ Typical Electrical Characteristics:

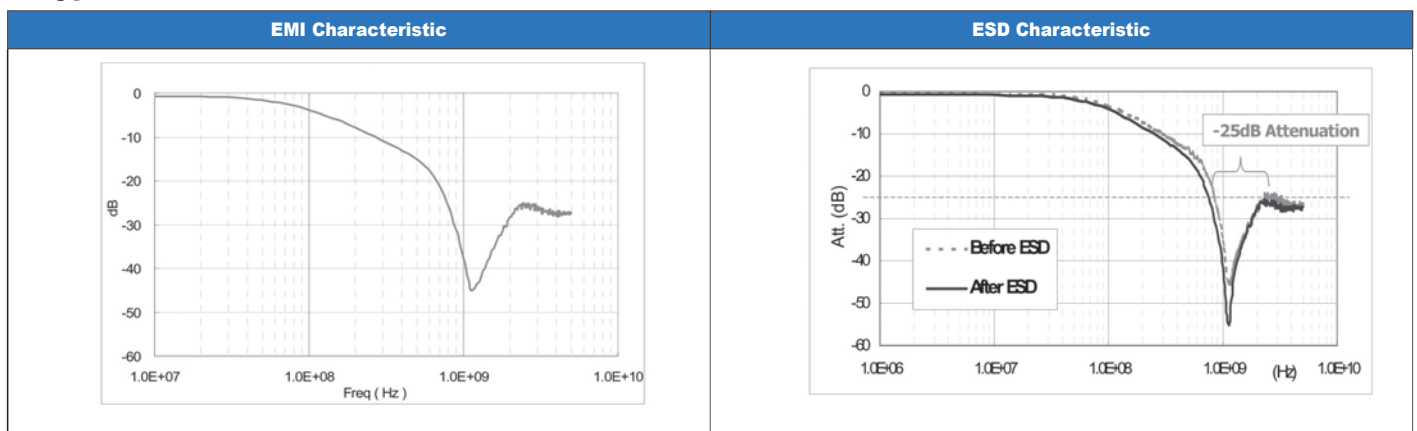

High Frequency Inductors

How to Order

| WL | 160808 | G | 4N7 | S | G | T | 03 |
|---------------------|--|---------------------------------|---|---|---------------------------------|--------------------|--|
| Product code | Dimension code | Material | Inductance | Tolerance | Specification | Packing | Rated Current |
| WL: HF Inductor | 160808 = L: 1.6mm W: 0.8mm T: 0.8mm 100505 = L: 1.0mm W: 0.5mm T: 0.5mm | A B C D E F G | For Ls<10nH 1N0=1.0nH 4N7=4.7nH 10N=10nH | S: ±0.3nH J: ±5% K: ±10% C: Customized | N=Normal A=±0.2nH G=Green | T=Reeled B=Bulk | 03=250mA or 300mA 02=150mA or 200mA |

Dimensions

| Symbol | WL1608 Series | WL1005 Seeries | WL0603 Seeries |
|--------|----------------|----------------|----------------|
| L | 1.60 ± 0.15 mm | 1.00 ± 0.10 | 0.60 ± 0.03 |
| W | 0.80 ± 0.15 mm | 0.50 ± 0.10 | 0.30 ± 0.03 |
| T | 0.80 ± 0.15 mm | 0.50 ± 0.10 | 0.30 ± 0.03 |
| Ts | 0.30 ± 0.20 mm | 0.25 ± 0.10 | 0.15 ± 0.05 |

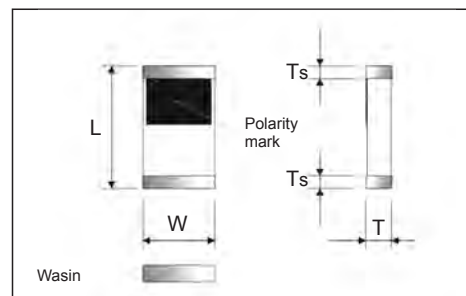

High Frequency Inductors 1608 (0603)

| Part Number. | L(nH) | Tolerance | Q Min (100 MHz) | Typical Q @ Frequency (MHz) | | | SRF Typical (MHz) | DC Resistance Max. (Ω) | IDC (mA) |
|-------------------|-------|-----------|-----------------|-----------------------------|-----|------|-------------------|------------------------|----------|
| | | | | 100 | 800 | 1800 | | | |
| WL160808G1N0SGT03 | 1.0 | ±0.3nH | 8 | 13 | 44 | 60 | 8100 | 0.10 | 300 |
| WL160808G1N2SGT03 | 1.2 | ±0.3nH | 8 | 13 | 44 | 60 | 8100 | 0.10 | 300 |
| WL160808G1N5SGT03 | 1.5 | ±0.3nH | 8 | 14 | 37 | 56 | 8100 | 0.10 | 300 |
| WL160808G1N8SGT03 | 1.8 | ±0.3nH | 8 | 12 | 37 | 55 | 8300 | 0.10 | 300 |
| WL160808G2N2SGT03 | 2.2 | ±0.3nH | 8 | 12 | 38 | 54 | 8000 | 0.10 | 300 |
| WL160808G2N7SGT03 | 2.7 | ±0.3nH | 8 | 13 | 38 | 53 | 7600 | 0.10 | 300 |
| WL160808G3N3SGT03 | 3.3 | ±0.3nH | 8 | 12 | 37 | 49 | 5800 | 0.12 | 300 |
| WL160808G3N9SGT03 | 3.9 | ±0.3nH | 8 | 14 | 44 | 62 | 5100 | 0.14 | 300 |
| WL160808G4N7SGT03 | 4.7 | ±0.3nH | 8 | 15 | 43 | 63 | 4600 | 0.16 | 300 |
| WL160808G5N6SGT03 | 5.6 | ±0.3nH | 8 | 15 | 45 | 59 | 4200 | 0.18 | 300 |
| WL160808G6N8JGT03 | 6.8 | ±5% | 8 | 15 | 43 | 58 | 3700 | 0.22 | 300 |
| WL160808G8N2JGT03 | 8.2 | ±5% | 8 | 15 | 44 | 52 | 3600 | 0.24 | 300 |
| WL160808G10NJGT03 | 10 | ±5% | 12 | 17 | 49 | 50 | 3500 | 0.26 | 300 |
| WL160808G12NJGT03 | 12 | ±5% | 12 | 15 | 41 | 37 | 2500 | 0.28 | 300 |
| WL160808G15NJGT03 | 15 | ±5% | 12 | 17 | 45 | 35 | 2600 | 0.32 | 300 |
| WL160808G18NJGT03 | 18 | ±5% | 12 | 16 | 45 | 39 | 2000 | 0.35 | 300 |
| WL160808G22NJGT03 | 22 | ±5% | 12 | 16 | 43 | 21 | 1800 | 0.40 | 300 |
| WL160808G27NJGT03 | 27 | ±5% | 12 | 16 | 41 | 11 | 1600 | 0.45 | 300 |
| WL160808G33NJGT03 | 33 | ±5% | 12 | 19 | 41 | 11 | 1500 | 0.55 | 300 |
| WL160808G39NJGT03 | 39 | ±5% | 12 | 19 | 42 | 17 | 1400 | 0.60 | 300 |
| WL160808G47NJGT03 | 47 | ±5% | 12 | 17 | 35 | - | 1300 | 0.70 | 300 |
| WL160808G56NJGT03 | 56 | ±5% | 12 | 19 | 31 | - | 1300 | 0.75 | 300 |
| WL160808G68NJGT03 | 68 | ±5% | 12 | 19 | 26 | - | 1150 | 0.85 | 300 |
| WL160808G82NJGT03 | 82 | ±5% | 12 | 19 | 21 | - | 1000 | 0.95 | 300 |
| WL160808GR10JGT03 | 100 | ±5% | 12 | 19 | 20 | - | 1000 | 1.00 | 300 |
| WL160808GR12JGT03 | 120 | ±5% | 12 | 19 | 16 | - | 950 | 1.20 | 300 |
| WL160808GR15JGT03 | 150 | ±5% | 12 | 19 | - | - | 800 | 1.50 | 300 |
| WL160808GR18JGT03 | 180 | ±5% | 12 | 19 | - | - | 750 | 1.90 | 300 |
| WL160808GR22JGT03 | 220 | ±5% | 12 | 18 | - | - | 680 | 2.20 | 300 |
| WL160808GR27JGT03 | 270 | ±5% | 12 | 20 | - | - | 600 | 2.50 | 300 |

High Frequency Inductors

High Frequency Inductors 1005 (0402)

| Part Number. | L(nH) | Tolerance | Q Min (100 MHz) | Typical Q @ Frequency (MHz) | | | SRF Typical (MHz) | DC Resistance Max. (Ω) | IDC (mA) |
|-------------------|-------|----------------|-----------------|-----------------------------|-----------|-----------|-------------------|------------------------|----------|
| | | | | 100 | 800 | 1800 | | | |
| WL100505G1N0SGT03 | 1.0 | ±0.3nH | 8 | 9 | 27 | 44 | 13000 | 0.12 | 300 |
| WL100505G1N2SGT03 | 1.2 | ±0.3nH | 8 | 9 | 25 | 45 | 12000 | 0.12 | 300 |
| WL100505G1N5SGT03 | 1.5 | ±0.3nH | 8 | 9 | 23 | 43 | 10000 | 0.13 | 300 |
| WL100505G1N8SGT03 | 1.8 | ±0.3nH | 8 | 9 | 24 | 43 | 9000 | 0.14 | 300 |
| WL100505G2N2SGT03 | 2.2 | ±0.3nH | 8 | 9 | 26 | 45 | 9000 | 0.16 | 300 |
| WL100505G2N7SGT03 | 2.7 | ±0.3nH | 8 | 9 | 26 | 42 | 8000 | 0.17 | 300 |
| WL100505G3N3SGT03 | 3.3 | ±0.3nH | 8 | 9 | 26 | 42 | 6500 | 0.19 | 300 |
| WL100505G3N9□GT03 | 3.9 | ±0.3nH ±10% | 8 | 9 | 26 | 40 | 6000 | 0.22 | 300 |
| WL100505G4N7□GT03 | 4.7 | ±0.3nH ±10% | 8 | 9 | 27 | 46 | 5000 | 0.23 | 300 |
| WL100505G5N6□GT03 | 5.6 | ±0.3nH ±10% | 8 | 10 | 28 | 40 | 4700 | 0.27 | 300 |
| WL100505G6N8□GT03 | 6.8 | ±5% ±10% | 8 | 10 | 28 | 36 | 4500 | 0.32 | 250 |
| WL100505G8N2□GT03 | 8.2 | ±5% ±10% | 8 | 10 | 28 | 36 | 4000 | 0.37 | 250 |
| WL100505G10N□GT03 | 10 | ±5% ±10% | 8 | 10 | 27 | 33 | 3500 | 0.42 | 250 |
| WL100505G12N□GT03 | 12 | ±5% ±10% | 8 | 11 | 31 | 41 | 3000 | 0.48 | 250 |
| WL100505G15N□GT03 | 15 | ±5% ±10% | 8 | 10 | 27 | 33 | 2900 | 0.53 | 250 |
| WL100505G18N□GT02 | 18 | ±5% ±10% | 8 | 11 | 29 | 31 | 2200 | 0.65 | 200 |
| WL100505G22N□GT02 | 22 | ±5% ±10% | 8 | 10 | 26 | 15 | 2100 | 0.80 | 200 |
| WL100505G27N□GT02 | 27 | ±5% ±10% | 8 | 10 | 23 | 15 | 2000 | 0.90 | 200 |
| WL100505G33N□GT02 | 33 | ±5% ±10% | 8 | 10 | 22 note 1 | 24 note 2 | 1900 | 1.00 | 200 |
| WL100505G39N□GT02 | 39 | ±5% ±10% | 8 | 10 | 19 note 1 | 20 note 2 | 1800 | 1.20 | 200 |
| WL100505G47N□GT02 | 47 | ±5% ±10% | 8 | 12 | 22 note 1 | 20 note 2 | 1500 | 1.30 | 200 |
| WL100505G56N□GT02 | 56 | ±5% ±10% | 8 | 12 | 22 note 1 | 18 note 2 | 1400 | 1.60 | 200 |
| WL100505G68N□GT02 | 68 | ±5% ±10% | 8 | 11 | 18 note 1 | 10 note 2 | 1200 | 1.90 | 180 |
| WL100505G82N□GT02 | 82 | ±5% ±10% | 8 | 12 | 20 note 1 | 7 note 2 | 1100 | 2.10 | 150 |
| WL100505GR10□GT01 | 100 | ±5% ±10% | 8 | 11 | 18 note 1 | - | 930 | 2.30 | 100 |

Note 1: at 500MHz

Note 2: at 1000MHz

For special inductance values, please contact with sales representatives of the HF Business Division.

High Frequency Inductors

High Frequency Inductors 0603 (0201)

| Walsiv Part Number. | L(nH) | Tolerance | Q Min (100 MHz) | Typical Q @ Frequency (MHz) | | | SRF Typical (MHz) | DC Resistance Max. (Ω) | IDC (mA) |
|---------------------|-------|-------------|-----------------|-----------------------------|-----|------|-------------------|---------------------------------|----------|
| | | | | 100 | 800 | 1800 | | | |
| WL060303G1N0SGT03 | 1.0 | $\pm 0.3nH$ | 4 | 13 | 17 | 26 | 13000 | 0.12 | 300 |
| WL060303G1N2SGT03 | 1.2 | $\pm 0.3nH$ | 4 | 14 | 17 | 26 | 13000 | 0.15 | 300 |
| WL060303G1N5SGT03 | 1.5 | $\pm 0.3nH$ | 4 | 14 | 17 | 26 | 13000 | 0.18 | 300 |
| WL060303G1N8SGT03 | 1.8 | $\pm 0.3nH$ | 4 | 15 | 17 | 28 | 10500 | 0.22 | 300 |
| WL060303G2N2SGT03 | 2.2 | $\pm 0.3nH$ | 4 | 15 | 18 | 28 | 9500 | 0.26 | 300 |
| WL060303G2N7SGT03 | 2.7 | $\pm 0.3nH$ | 4 | 16 | 18 | 18 | 8500 | 0.32 | 300 |
| WL060303G3N3SGT03 | 3.3 | $\pm 0.3nH$ | 4 | 16 | 19 | 28 | 7500 | 0.38 | 300 |
| WL060303G3N9SGT03 | 3.9 | $\pm 0.3nH$ | 4 | 16 | 20 | 26 | 6800 | 0.45 | 300 |
| WL060303G4N7SGT03 | 4.7 | $\pm 0.3nH$ | 4 | 16 | 20 | 26 | 6000 | 0.50 | 300 |
| WL060303G5N6SGT03 | 5.6 | $\pm 0.3nH$ | 5 | 16 | 20 | 25 | 5500 | 0.60 | 300 |
| WL060303G6N8JGT03 | 6.8 | $\pm 5\%$ | 5 | 16 | 20 | 25 | 4800 | 0.70 | 250 |
| WL060303G8N2JGT03 | 8.2 | $\pm 5\%$ | 5 | 16 | 20 | 23 | 4600 | 0.90 | 250 |
| WL060303G10NJGT03 | 10 | $\pm 5\%$ | 5 | 16 | 20 | 23 | 4000 | 1.20 | 250 |
| WL060303G12NJGT03 | 12 | $\pm 5\%$ | 5 | 16 | 19 | 22 | 3500 | 1.30 | 250 |
| WL060303G15NJGT03 | 15 | $\pm 5\%$ | 5 | 15 | 19 | 18 | 3000 | 1.40 | 250 |
| WL060303G18NJGT02 | 18 | $\pm 5\%$ | 5 | 15 | 19 | 16 | 2500 | 1.50 | 200 |
| WL060303G22NJGT02 | 22 | $\pm 5\%$ | 5 | 14 | 18 | 15 | 2200 | 1.80 | 200 |
| WL060303G27NJGT03 | 27 | $\pm 5\%$ | 5 | 13 | 18 | 9 | 1800 | 2.00 | 200 |
| WL060303G33NJGT03 | 33 | $\pm 5\%$ | 5 | 13 | 17 | 7 | 1500 | 2.30 | 200 |

Package

1. Reel material; Polystyrene
2. Ordering code No., Quantity, Batch No. and Walsin
3. Parts per reel:

| Size | Quantity / reel |
|----------------|-----------------|
| WL 1608 Series | 4K pcs |
| WL 1005 Series | 10K pcs |
| WL 0603 Series | 10K pcs |

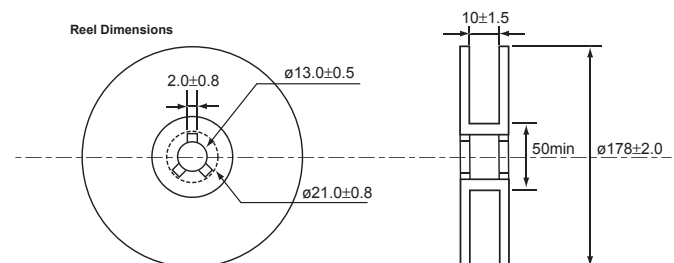

High Frequency Devices - Common Mode Filter - RFCMF1632140M2T / RFCMF1632100M3T

How to Order

| RF | CMF | 163214 | 0 | M | 2 | T |
|---------------|-------------------------|--|--------------------------|--------------------------|----------------------|---|
| Walsin | Product code | Dimension code | Unit of dimension | Application | Specification | Packing |
| RF Device | CMF: Common Mode Filter | 163214 = Length = 16 Width = 32 Thickness = 14 163210 = Length = 16 Width = 32 Thickness = 10 | 0: 0.1 mm 1: 1.0 mm | M: USB 2.0 / IEEE1394 | Design Code | T=7" Reeled G=10" Reeled B=Bulk X: SFC product |

Dimensions

| Symbol | RFCMF1632140M2T | RFCMF1632100M3T |
|--------|-----------------|-----------------|
| L | 1.60 ± 0.20 mm | 1.60 ± 0.20 mm |
| W | 3.20 ± 0.20 mm | 3.20 ± 0.20 mm |
| T | 1.40 ± 0.20 mm | 1.00 ± 0.20 mm |
| P | 1.10 ± 0.20 mm | 1.10 ± 0.20 mm |
| a | 0.60 ± 0.20 mm | 0.60 ± 0.20 mm |
| b | 0.50 ± 0.20 mm | 0.50 ± 0.20 mm |

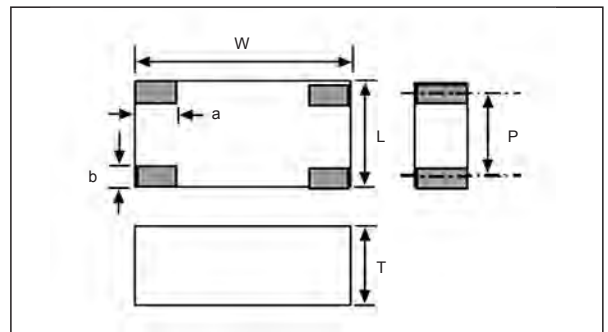

RFCMF1632140M2T Series

| Item | Specification |
|----------------------------------|---------------------------|
| Common Mode Attenuation | Min. 9 dB @ 140MHz ~ 1GHz |
| Differential Mode Insertion Loss | Max. 0.8 dB @ 240MHz |
| DC Resistance | Max. 2.5Ω |
| Rated Current | 300 mA |
| Characteristic Impedance | (Differential) 90Ω |

RFCMF1632100M3T Series

| Item | Specification |
|----------------------------------|---------------------------|
| Common Mode Attenuation | Min. 9 dB @ 240MHz ~ 1GHz |
| Differential Mode Insertion Loss | Max. 0.6 dB @ 240MHz |
| DC Resistance | Max. 1.5Ω |
| Rated Current | 300 mA |
| Characteristic Impedance | (Differential) 90Ω |

Typical Electrical Characteristics:

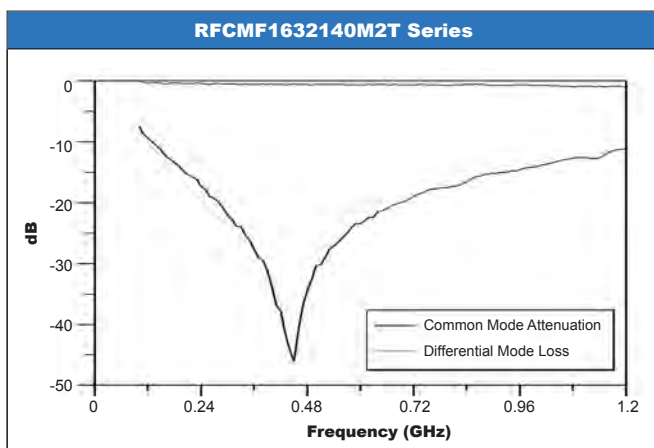

Typical Electrical Characteristics:

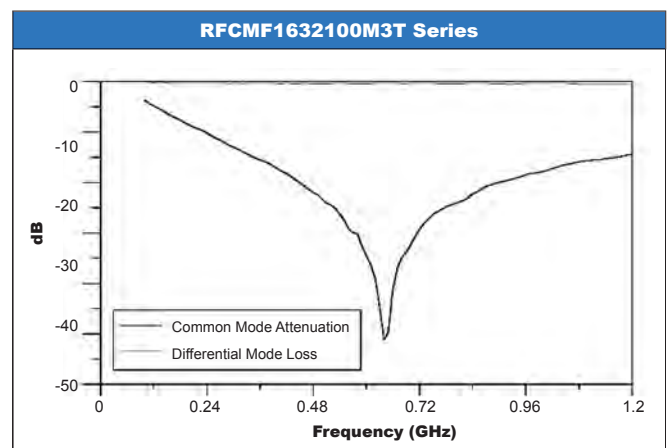

High Frequency Devices - Common Mode Filter - RFCMF1220100M□T

How to Order

| RF | CMF | 122010 | 0 | M | □ | T |
|---------------|-------------------------|---|--------------------------|--------------------------|----------------------|---|
| Walsin | Product code | Dimension code | Unit of dimension | Application | Specification | Packing |
| RF Device | CMF: Common Mode Filter | 122010 = Length = 12 Width = 20 Thickness = 10 | 0: 0.1 mm 1: 1.0 mm | M: USB 2.0 / IEEE1394 | Design Code | T=7" Reeled G=10" Reeled B=Bulk X: SFC product |

Dimensions

| Symbol | Dimension |
|--------|----------------|
| L | 1.20 ± 0.20 mm |
| W | 2.00 ± 0.20 mm |
| T | 1.00 ± 0.20 mm |
| P | 0.80 ± 0.10 mm |
| a | 0.45 ± 0.20 mm |
| b | 0.40 ± 0.20 mm |

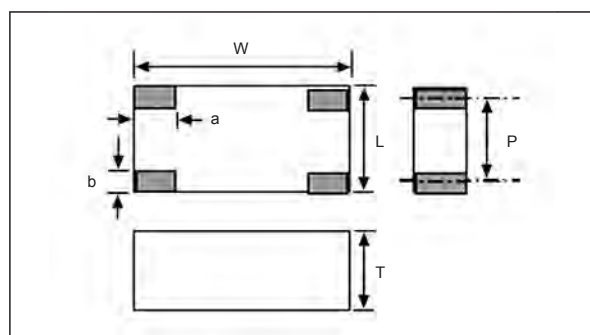

RFCMF1220100M3T Series

| Item | Specification |
|----------------------------------|---------------------------|
| Common Mode Attenuation | Min. 9 dB @ 240MHz ~ 1GHz |
| Differential Mode Insertion Loss | Max. 0.6 dB @ 240MHz |
| DC Resistance | Max. 1.5Ω |
| Rated Current | 300 mA |
| Characteristic Impedance | (Differential) 90Ω |

RFCMF1220100M4T Series

| Item | Specification |
|----------------------------------|---------------------------|
| Common Mode Attenuation | Min. 9 dB @ 130MHz ~ 1GHz |
| Differential Mode Insertion Loss | Max. 1.0 dB @ 240MHz |
| DC Resistance | Max. 2.5Ω |
| Rated Current | 200 mA |
| Characteristic Impedance | (Differential) 90Ω |

Typical Electrical Characteristics:

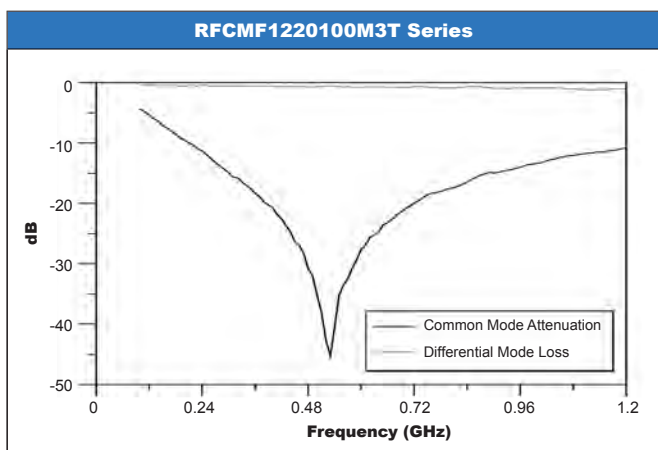

Typical Electrical Characteristics:

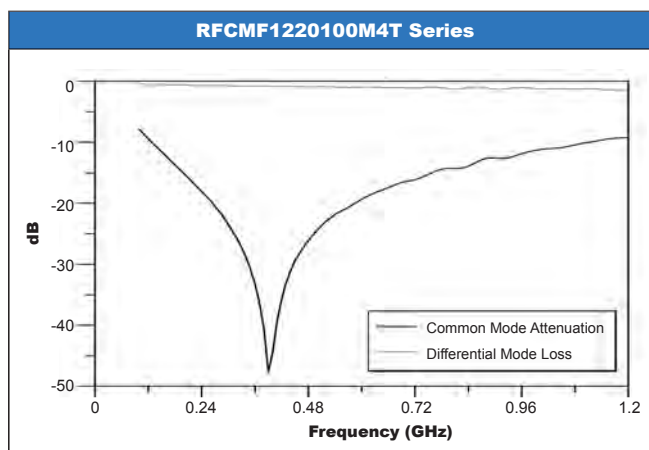

High Frequency Devices - Common Mode Filter - RGCMF1220080M5T

How to Order

| RG | CMF | 122008 | 0 | M | 5 | T |
|--|---|---|--|--|-------------------------------------|---|
| Walsin RG: RF /Pd free device | Product code CMF: Common Mode Filter | Dimension code 122008 = Length = 12 Width = 20 Thickness = 8 | Unit of dimension 0: 0.1 mm 1: 1.0 mm | Application M: USB 2.0 / IEEE1394 | Specification Design Code | Packing T=7" Reeled G=10" Reeled B=Bulk X: SFC product |

Dimensions

| Symbol | Dimension |
|--------|----------------|
| L | 2.00 ± 0.10 mm |
| W | 1.25 ± 0.10 mm |
| T | 0.80 ± 0.10 mm |
| A | 0.35 ± 0.10 mm |
| B | 0.55 ± 0.10 mm |

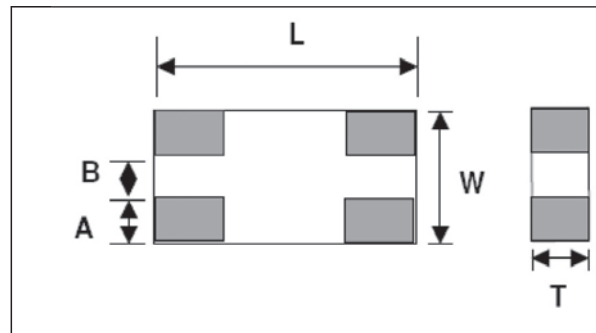

RGCMF1220080M5T Series

| Item | Specification |
|--------------------------|-----------------------|
| Common Mode Attenuation | 120 ohm ±20% @ 100MHz |
| DC Resistance | Max. 1.5Ω |
| Rated Current | 200 mA |
| Characteristic Impedance | 90 Ω (Typical) |
| Operating Temperature | -40°C ~ 85°C |

Typical Electrical Characteristics:

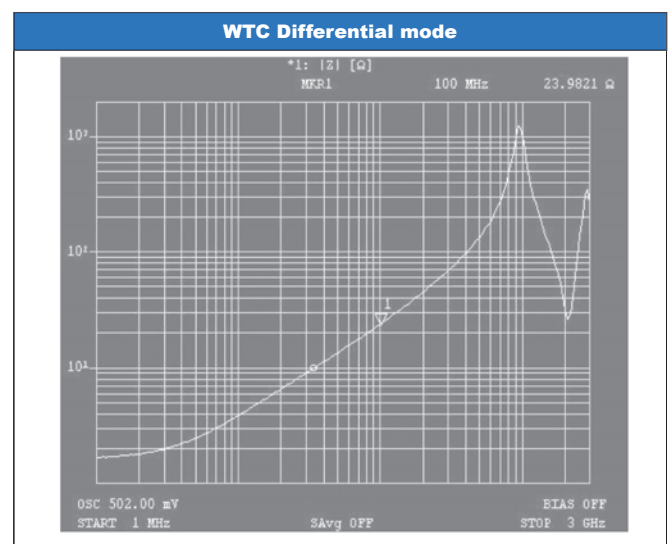
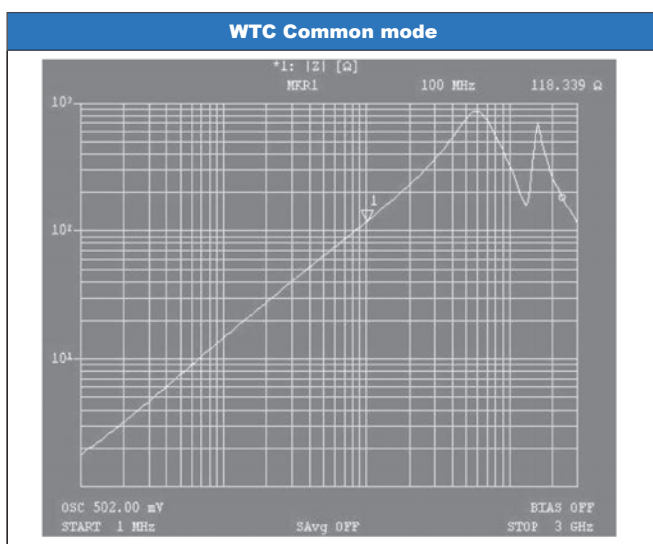

High Frequency Devices - Common Mode Filter - RFCMF1210080M□T

How to Order

| RF | CMF | 121008 | 0 | M | □ | T |
|-----------------------------|--|---|--|--|-------------------------------------|---|
| WalGin RF: Device | Product code CMF: Common Mode Filter | Dimension code 121008 = Length = 12 Width = 10 Thickness = 8 | Unit of dimension 0: 0.1 mm 1: 1.0 mm | Application M: USB 2.0 / IEEE1394 | Specification Design Code | Packing T=7" Reeled G=10" Reeled B=Bulk X: SFC product |

Dimensions

| Symbol | RFCMF120080M1T | RFCMF1210080M2T |
|--------|----------------|-----------------|
| L | 1.27 ± 0.1 mm | 1.28 ± 0.1 mm |
| W | 1.01 ± 0.1 mm | 1.02 ± 0.1 mm |
| T | 0.79 ± 0.1 mm | 0.81 ± 0.1 mm |

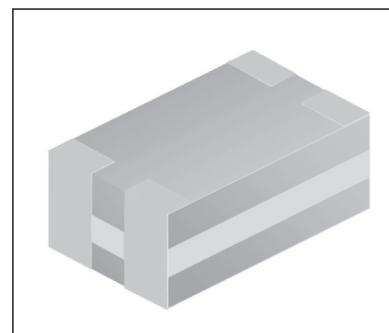
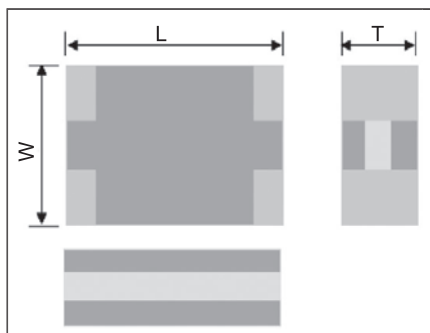

RFCMF1210080M1T Series

| Item | Specification |
|--------------------------|----------------------|
| Characteristic Impedance | 90 ohm |
| DC Resistance | 0.85 ohm (max.) |
| Rated Current | 100 mA |
| Common Mode Attenuation | 70 ohm+/-20%@ 100HMZ |
| Operating Temperature | -40°C ~ +85°C |

RFCMF1210080M2T Series

| Item | Specification |
|--------------------------|-----------------------|
| Characteristic Impedance | 90 ohm |
| DC Resistance | 1.0 ohm (max.) |
| Rated Current | 100 mA |
| Common Mode Attenuation | 100 ohm+/-20%@ 100HMZ |
| Operating Temperature | -40°C ~ +85°C |

Impedance Vs. Frequency:

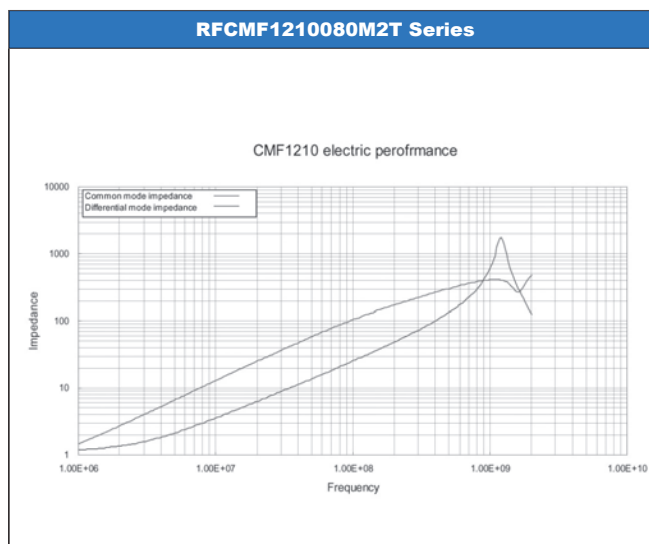
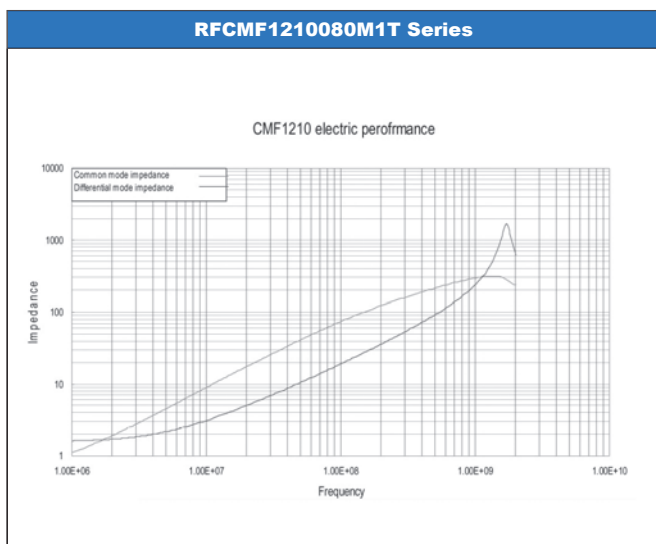

■ Multilayer Chip Varistor (MLV) - VZ Series & VH Series

■ How to Order

| VH | 0402 | M | 050 | C | G | T | 330 | - |
|---|---|----------------------------|--|--|--------------------|--------------------|---|------------------------|
| Type code | Chip Size | Style | Rated Voltage | Cap. Tolerance | Termination | Packing | Cap. code (pf) | Special Request |
| V: Walsin ZnO Varistor H: High Speed and RF, and Special Capacitance Concern Z: General Purpose | 0402, 0603 0805, 1206 Code is L x W (in inches) 0402 = 0.4 x 0.2 0603 = 0.6 x 0.3 0805 = 0.8 x 0.5 1206 = 1.2 x 0.6 | M: Multilayer A: Array* | 050: 5.5Vdc 090: 9.0Vdc 120: 12.0Vdc 140: 14.0Vdc 180: 18.0Vdc 300: 30.0Vdc | A: Typ. Capacitance for Z series C: Max. capacitance for H series | G : Green Material | T=Reeled B=Bulk | This item is only for H Series. Two significant digits followed by number of Zeros 3R0=3pF when C < 10pF 330=33x10 ⁰ =33pF 101=10x10 ¹ =100pF 102=10x10 ² =1000pF | |

*Array: Please contact sales for availability

■ Introduction - Plated & Lead-free Termination

High Speed ESD Voltage Suppressor is an advanced series of Walsin's Multilayer Chip Varistor (MLV). Nowadays, more and more communication devices become compact and apply denser and higher frequency circuits inside. Protection against the electronic static discharge (ESD) generated from human body transient voltage surge is more important when downsize of high-speed transistor makes its vulnerability to ESD and surge. Walsin's High Speed ESD Voltage Suppressor provides protection from ESD and EFT in high-speed data line and radio frequency (RF) circuits. Also, if capacitance of MLV is a concern to circuit designers, Walsin MLV H Series would supply a solution, MLV with specified capacitance and range. It is compatible with modern reflow and wave soldering procedures. We would give you a solution to transient over voltage and ESD protection to your products.

■ Features

- Multilayer Fabrication Technology
- Small size (0402 & 0603)
- -55°C to 125°C Operating Temperature Range
- Operating Voltage Range $V_M(DC)$ at 5.5V ~ 85V
- Able to withstand ESD test of IEC-61000-4-2
- Bi-directional Clamping characteristic
- Standard / Low / Customized Capacitance Types Available

■ Applications

- Protection of Cellular Phones, PDA, High Speed Data Line...etc.
- ESD Protection for Components Sensitive to IEC 61000-4-2, Provides Circuit Board Transient Voltage Protection for Transistors.
- Protection of Video & Audio ports.

■ Dimensions

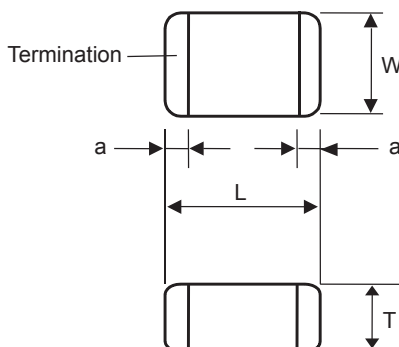

Unit: mm

| Size | 0402 | 0603 | 0805 | 1206 |
|------|-------------|-------------|-------------|-------------------------------|
| L | 1.00 ± 0.10 | 1.60 ± 0.15 | 2.00 ± 0.20 | 3.20 ± 0.20 |
| W | 0.50 ± 0.10 | 0.80 ± 0.15 | 1.25 ± 0.20 | 1.60 ± 0.20 |
| T | 0.50 ± 0.10 | 0.80 ± 0.15 | 0.80 ± 0.20 | 0.80 ± 0.10* 1.10 ± 0.20** |
| a | 0.25 ± 0.15 | 0.35 ± 0.15 | 0.50 ± 0.20 | 0.65 ± 0.25 |

Note: *Means VZ1206 5.5Vdc~22Vdc items
**Means VZ1206 26Vdc~85Vdc items

■ Multilayer Chip Varistor (MLV) - VZ Series & VH Series

■ Quick Reference Specifications

VH Series

| Symbol | Maximum Ratings | | | Specifications | | | |
|------------------|------------------------------------|---|---|-------------------------------------|-------------------------|------------------------|----------|
| | Maximum Continuous Working Voltage | Maximum Non-Repetitive Surge Energy (10/1000µs) | Max. Clamping Voltage at Specified Current (8/20µs) | Nominal Voltage at 1mA (DC) Current | | Max. Capacitance @1MHz | |
| | | | | V _{N(DC)} Min. | V _{N(DC)} Max. | C | |
| Part Number | V _{M(DC)} (V) | W _{TM} (J) | V _C (V) | (V) | (V) | (pF) | % |
| VH0402M050CGT5R0 | 5 | 0.05 | 55 at 1A | 20 | 30 | 5 | +80/-20 |
| VH0402M050CGT100 | 5 | 0.05 | 60 at 1A | 24 | 36 | 10 | ± 30 |
| VH0402M050CGT220 | 5 | 0.05 | 45 at 1A | 15 | 25 | 22 | ± 30 |
| VH0402M050CGT330 | 5 | 0.05 | 45 at 1A | 15 | 25 | 33 | ± 30 |
| VH0402M050CGT560 | 5 | 0.05 | 45 at 1A | 15 | 25 | 56 | ± 30 |
| VH0402M050CGT101 | 5 | 0.05 | 30 at 1A | 11 | 21 | 100 | ± 30 |
| VH0402M120CGT5R0 | 12 | 0.05 | 85 at 1A | 33 | 50 | 5 | +80/-20 |
| VH0402M120CGT100 | 12 | 0.05 | 70 at 1A | 27 | 42 | 10 | ± 30 |
| VH0402M120CGT220 | 12 | 0.05 | 55 at 1A | 20 | 30 | 22 | ± 30 |
| VH0402M120CGT330 | 12 | 0.05 | 55 at 1A | 20 | 30 | 33 | ± 30 |
| VH0402M120CGT560 | 12 | 0.05 | 55 at 1A | 20 | 30 | 56 | ± 30 |
| VH0402M120CGT101 | 12 | 0.05 | 55 at 1A | 20 | 30 | 100 | ± 30 |
| VH0402M240CGT0R8 | 24 | 0.05 | 200 at 1A | 100 | 150 | 0.8~1 | ± 30 |
| VH0402M240CGT2R5 | 24 | 0.05 | 200 at 1A | 100 | 150 | 2~4 | ± 30 |
| VH0603M050CGT5R0 | 5 | 0.1 | 55 at 1A | 20 | 30 | 5 | +80/-20% |
| VH0603M050CGT100 | 5 | 0.1 | 60 at 1A | 24 | 36 | 10 | +/- 30% |
| VH0603M050CGT220 | 5 | 0.1 | 45 at 1A | 15 | 25 | 22 | +/- 30% |
| VH0603M050CGT330 | 5 | 0.1 | 45 at 1A | 15 | 25 | 33 | +/- 30% |
| VH0603M050CGT560 | 5 | 0.1 | 45 at 1A | 15 | 25 | 56 | +/- 30% |
| VH0603M050CGT101 | 5 | 0.1 | 30 at 1A | 11 | 21 | 100 | +/- 30% |
| VH0603M120CGT5R0 | 12 | 0.1 | 85 at 1A | 33 | 50 | 4~9 | +80/-20% |
| VH0603M120CGT100 | 12 | 0.1 | 70 at 1A | 27 | 42 | 10 | +/- 30% |
| VH0603M120CGT220 | 12 | 0.1 | 55 at 1A | 20 | 30 | 22 | +/- 30% |
| VH0603M120CGT330 | 12 | 0.1 | 55 at 1A | 20 | 30 | 33 | +/- 30% |
| VH0603M120CGT560 | 12 | 0.1 | 55 at 1A | 20 | 30 | 56 | +/- 30% |
| VH0603M120CGT820 | 12 | 0.1 | 55 at 1A | 20 | 30 | 82 | +/- 30% |
| VH0603M120CGT101 | 12 | 0.1 | 55 at 1A | 20 | 30 | 100 | +/- 30% |
| VH0603M240CGT0R8 | 24 | 0.1 | 200 at 1A | 100 | 150 | 0.8~1 | +/- 30% |
| VH0603M240CGT2R5 | 24 | 0.1 | 200 at 1A | 100 | 150 | 2~4 | +/- 30% |

SPECIFICATIONS

| Part Number | Maximum Continuous Working Voltage | Typical ESD Trigger Voltage | Typical ESD clamping Voltage after 30ns | Leakage Current @V _{DC} | Minimum ESD pulse withstand | Capacitance |
|-------------------|------------------------------------|-----------------------------|---|----------------------------------|-----------------------------|------------------------|
| | | | | | | @1MHz |
| | V _{M(DC)} (V) | V _T (V) | V _{clamp} (V) | µA (V) | Times | C _p (pF) |
| VH0402M060CGT0R20 | 6 | 150 | 30 | 0.05 | >2000 | 0.2-0.1/+0.5 |
| VH0402M240CGT0R05 | 24 | 350 | 50 | 0.001 | >2000 | 0.05+0.05/-0.05 |
| VH0603M060CGT0R20 | 6 | 150 | 30 | 0.05 | >2000 | 0.2-0.1/+0.5 |
| VH0603M240CGT0R05 | 24 | 350 | 50 | 0.001 | >2000 | 0.05+0.05/-0.05 |

■ Multilayer Chip Varistor (MLV) - VZ Series & VH Series

■ Quick Reference Specifications

VZ Series

| Symbol Part Number | Maximum Ratings | | | | | Specifications | | |
|---------------------------|------------------------------------|---------------------|---|---|---|-------------------------------------|--------------------------|------------------------|
| | Maximum Continuous Working Voltage | | Maximum Non-Repetitive Surge Current (8/20 μ s) | Maximum Non-Repetitive Surge Energy (10/1000 μ s) | Max. Clamping Voltage at Specified Current (8/20 μ s) | Nominal Voltage at 1mA (DC) Current | | Max. Capacitance @1KHz |
| | V _M (DC) | V _M (AC) | I _{TM} | W _{TM} | V _c | V _N (DC) Min. | V _N (DC) Max. | C |
| | (V) | (V) | (A) | (J) | (V) | (V) | (V) | (pF) |
| VZ0402M050AGT | 5.5 | 4 | 20 | 0.05 | 20 at 1A | 8.0 | 11.0 | 295 |
| VZ0402M090AGT | 9 | 6 | 20 | 0.05 | 23 at 1A | 10.2 | 13.8 | 190 |
| VZ0402M110AGT | 11 | 8 | 20 | 0.05 | 25 at 1A | 12.75 | 17.25 | 160 |
| VZ0402M140AGT | 14 | 11 | 20 | 0.05 | 30 at 1A | 15.3 | 20.7 | 135 |
| VZ0402M180AGT | 18 | 14 | 20 | 0.05 | 40 at 1A | 21.6 | 26.4 | 93 |
| VZ0603M050AGT | 5.5 | 4 | 30 | 0.1 | 20 at 1A | 8.0 | 11.0 | 800 |
| VZ0603M090AGT | 9 | 6 | 30 | 0.1 | 23 at 1A | 10.2 | 13.8 | 680 |
| VZ0603M140AGT | 14 | 11 | 30 | 0.1 | 30 at 1A | 15.3 | 20.7 | 350 |
| VZ0603M180AGT | 18 | 14 | 30 | 0.1 | 39 at 1A | 21.6 | 26.4 | 270 |
| VZ0603M260AGT | 26 | 20 | 30 | 0.1 | 54 at 1A | 29.7 | 36.3 | 200 |
| VZ0603M300AGT | 30 | 25 | 30 | 0.1 | 65 at 1A | 35.1 | 42.9 | 120 |
| VZ0603M380AGT | 38 | 30 | 30 | 0.1 | 77 at 1A | 42.3 | 51.7 | 100 |
| VZ0805M050AGT | 5.5 | 4 | 80 | 0.1 | 20 at 1A | 8.0 | 11.0 | 1600 |
| VZ0805M090AGT | 9 | 6 | 80 | 0.1 | 23 at 1A | 10.2 | 13.8 | 1180 |
| VZ0805M140AGT | 14 | 10 | 100 | 0.2 | 35 at 1A | 15.3 | 20.7 | 1180 |
| VZ0805M180AGT | 18 | 14 | 100 | 0.2 | 39 at 1A | 21.6 | 26.4 | 550 |
| VZ0805M220AGT | 22 | 17 | 100 | 0.2 | 44 at 1A | 24.3 | 29.7 | 400 |
| VZ0805M260AGT | 26 | 20 | 100 | 0.3 | 54 at 1A | 29.7 | 36.3 | 350 |
| VZ0805M300AGT | 30 | 25 | 100 | 0.3 | 65 at 1A | 35.1 | 42.9 | 310 |
| VZ0805M380AGT | 38 | 30 | 100 | 0.3 | 77 at 1A | 42.3 | 51.7 | 280 |
| VZ0805M450AGT | 45 | 35 | 80 | 0.3 | 90 at 1A | 50.4 | 61.6 | 195 |
| VZ1206M050AGT | 5.5 | 4 | 100 | 0.2 | 20 at 1A | 8.0 | 11.0 | 3200 |
| VZ1206M140AGT | 14 | 11 | 100 | 0.3 | 30 at 1A | 15.3 | 20.7 | 1150 |
| VZ1206M180AGT | 18 | 14 | 100 | 0.3 | 38 at 1A | 21.6 | 26.4 | 900 |
| VZ1206M220AGT | 22 | 17 | 100 | 0.4 | 44 at 1A | 24.3 | 29.7 | 840 |
| VZ1206M260AGT | 26 | 20 | 100 | 0.5 | 54 at 1A | 29.7 | 36.3 | 490 |
| VZ1206M300AGT | 30 | 25 | 100 | 0.6 | 65 at 1A | 35.1 | 42.9 | 440 |
| VZ1206M380AGT | 38 | 30 | 100 | 0.7 | 77 at 1A | 42.3 | 51.7 | 400 |
| VZ1206M450AGT | 45 | 35 | 100 | 0.8 | 90 at 1A | 50.4 | 61.6 | 310 |
| VZ1206M560AGT | 56 | 40 | 100 | 1.0 | 110 at 1A | 61.2 | 74.8 | 280 |
| VZ1206M650AGT | 65 | 50 | 100 | 0.5 | 135 at 1A | 73.8 | 90.2 | 240 |
| VZ1206M850AGT | 85 | 60 | 100 | 0.6 | 165 at 1A | 90.0 | 110 | 160 |

■ Multilayer Chip Varistor (MLV) - VZ Series & VH Series

■ Taping Specifications

A. Paper tape size specification:

Unit: mm

| Label | 0402 | 0603 | 0805 | 1206 |
|-------|-----------------|-----------------|-----------------|-----------------|
| A | 0.62 ± 0.03 | 0.95 ± 0.05 | 1.45 ± 0.05 | 1.88 ± 0.05 |
| B | 1.12 ± 0.03 | 1.80 ± 0.05 | 2.25 ± 0.05 | 3.50 ± 0.05 |
| K | 0.60 ± 0.03 | 0.87 ± 0.05 | 0.87 ± 0.05 | 1.24 ± 0.05 |

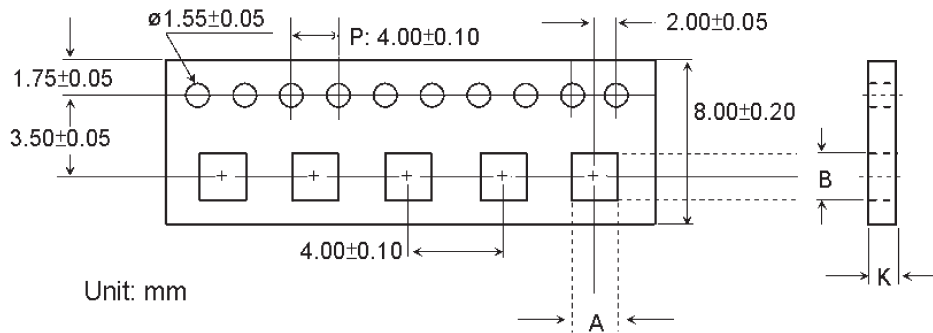

B. Reel size specification

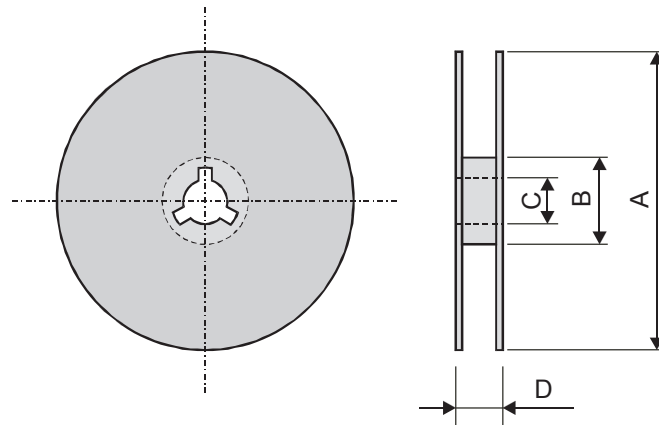

| Symbol | A | B | C | D |
|-----------|-------------------------|------------------------|----------------|----------------|
| Dimension | $\text{Ø}178.0 \pm 2.0$ | $\text{Ø}60.0 \pm 1.0$ | 13.0 ± 0.2 | 10.0 ± 1.5 |

C. Packaging on tape & reel:

| Size | 0402 | 0603 | 0805 | 1206 |
|-----------------|---------|--------|--------|--------|
| Quantity / reel | 10K pcs | 4K pcs | 3K pcs | 3K pcs |

A series of horizontal dotted lines for writing.

Walsin Technology Corporation

Yang-Mei Plant / Sales Office

Walsin Technology Corporation
556-1, Kao-Shi Road, Yang-Mei,
Tao-Yuan, Taiwan
Tel: +886-3-475-8711
Fax: +886-3-475-7130
Email: info@passivecomponent.com

Kaohsiung Plant, Taiwan

Walsin Technology Corporation
1st, West 13 Street, K.E.P.Z.
Kaohsiung, Taiwan
Tel: +886-7-821-8171
Fax: +886-7-813-1661
Email: info@passivecomponent.com

China - Dalang Plant / Sales Office

Dongguan Walsin Tech. Electronics CO., Ltd.
Xiniupo Administrative Zone,
Dalang Town, Dongguan City,
Guangdong Province 523799
Tel: +86-769-3115168
Fax: +86-769-3115188
Email: davidcheng@passivecomponent.com

China - Suzhou Plant / Sales Office

Suzhou Walsin Technology Electronics Co., Ltd.
No. 369, Changyan Street,
Suzhou Industrial Park,
Jiangsu Province 215126
Tel: +86-512-628-36888
Fax: +86-512-628-37888
Email: bingowang@passivecomponent.com

China - Xi-An Sales Office

E201, Tangy-Yue-Ge, Software Park,
No.72 the 2nd Keji Road, Xi'an City,
Shaanxi Province 710075
Tel: +86-29-87607808
Fax: +86-29-87607806
Email: susanch@263.net

China - Tianjin Sales Office

Walsin Technology Corporation (Tian Jin)
No.51 The Ninth Avenue, Tianjin Technological
Development Area(TEDA) Tianjin 300457
Tel: +86-22-59820009
Fax: +86-22-59820008
Email: Johnsonwang@passivecomponent.com

Malaysia - Kuala Lumpur Sales Office

Walsin Technology Corporation, (M) SDN. BHD.
Unit 208, Block B3, Leisure Commerce Square,
No. 9, Jalan PJS 8/9, 46150 Petaling Jaya,
Selangor Darul Ehsan, Malaysia
Tel: +603-7877-8766
Fax: +603-7877-8768
Email: teckanntan@my.passivecomponent.com

Malaysia - Penang Sales Office

Walsin Technology Corporation(M) SND. BHD.
1-3-6, Krystal Point II, Lebuah Bukit Kecil 6,
11900 Bayan Lepas, Penang, Malaysia
Tel: +604-6465767
Fax: +604-6461767
Email: erinlee@my.passivecomponent.com

Germany - Munich Sales Office

Walsin Technology Corporation Europe
Stefan-George-Ring 29, 81929 Munich, Germany
Tel: +49-(0)89-9308-6475
Fax: +49-(0)89-9308-6464
Email: aw@passivecomponent.com

United States - West Coast Sales Office

Walsin Technology Corporation, USA
39500 Stevenson Place Suite 206,
Fremont, CA 94539, USA
Tel: +1-510-713-1190
Fax: +1-510-713-8097
Email: leeku@passivecomponent.com

Singapore - Sales Office

Walsin Electronics (S) Pte. Ltd.
2 Jurong East Street 21,
#04-33F IMM Building,
Singapore 609601
Tel: +65-6794-3600
Fax: +65-6861-3381
Email: peterchew@sg.passivecomponent.com

JAPAN - R&D / Sales Office

Walsin Technology Corporation (Japan)
D-442, KSP R&D Business Park Building,
3-2-1 Sakado Takatsuku, Kawasaki City,
Kanagawa 213-0012, Japan
Tel: +81-44-829-4626
Fax: +81-44-829-4723
Nitsuko Electronic Corporation
Tel: +81-44-820-1570
Fax: +81-44-820-1571
Email: sakanotsu@nitsuko-ele.co.jp