

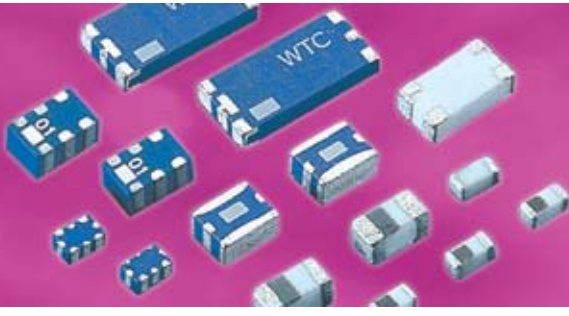

Walsin Technology Corporation



# RF Devices and High Frequency Inductors

# 2008



## Product Portfolio



**Multilayer Ceramic Capacitors (MLCC)**

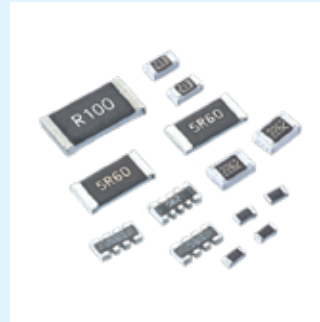

**Chip-Resistor**



**RF Device and High Frequency Inductors**



**Varistors and SMD-Varistors**

## IEC-63 Nominal Resistance / Capacitance

<b>E1</b>	100																							
<b>E3</b>	100								220								470							
<b>E6</b>	100				150				220				330				470				680			
<b>E12</b>	100	120	150	180	220	270	330	390	470	560	680	820												
<b>E24</b>	100	110	120	130	150	160	180	200	220	240	270	300	330	360	390	430	470	510	560	620	680	750	820	910
<b>E96</b>	100	102	121	124	147	150	178	182	215	221	261	267	316	324	383	392	464	475	562	576	681	698	825	845
	105	107	127	130	154	158	187	191	226	232	274	280	332	340	402	412	487	499	590	604	715	732	866	887
	110	113	133	137	162	165	196	200	237	243	287	294	348	357	422	432	511	523	619	634	750	768	909	931
	115	118	140	143	169	174	205	210	249	255	301	309	365	374	442	453	536	549	649	665	787	806	953	976

E6:  $\sqrt[6]{10} \approx 1.46$  E12:  $\sqrt[12]{10} \approx 1.21$

E1 series resistance: 1Ω, 10Ω, 100Ω, 1000Ω, 10000Ω, 100000Ω

## INDEX

<b>Subject</b>	<b>Page</b>
2.4 GHz Bluetooth/WLAN-Chip Antenna 5220 .....	1
2.4 GHz Bluetooth/WLAN-Chip Antenna 3216 .....	2
2.4 GHz Bluetooth/WLAN-Chip Antenna 8010 .....	3
2.4 GHz Bluetooth/WLAN-Free Antenna 9937.....	4
2.4 GHz Bluetooth/WLAN-Free Antenna 1903.....	5
2.4 GHz High Frequency Devices-Band Pass Filter 3225 .....	6
2.4 GHz High Frequency Devices-Band Pass Filter 2520 .....	7~8
2.4 GHz High Frequency Devices-Band Pass Filter 2012 .....	9~11
2.4 GHz High Frequency Devices-Band Pass Filter 1608 .....	12
2.4 GHz High Frequency Devices-Balanced Filter 2520 .....	13~15
2.4 GHz High Frequency Devices-Balanced Filter 2012 .....	16~19
2.4 GHz High Frequency Devices-Low Pass Filter 2012 .....	20
2.4GHz High Frequency Devices-Balun 2012 .....	21~22
2.4GHz High Frequency Devices-Balun 1608 .....	23~24
2.4/ 4.9/ 5.2/ 5.8 GHz WLAN IEEE802.11 a/b/g Combo-Chip Antenna 6050 .....	25~26
2.4/ 4.9/ 5.2/ 5.8 GHz High Frequency Devices-Diplexer 2012 .....	27
4.9/ 5.2/ 5.8 GHz High Frequency Devices-Balun 2012 .....	28
4.9/ 5.2/ 5.8 GHz High Frequency Devices-Band Pass Filter 2012 .....	29
High Frequency Devices-EMI Filter Array .....	30~31
High Frequency Inductors .....	32~34
High Frequency Devices-Common Mode Filter 1632.....	35
High Frequency Devices-Common Mode Filter 1220.....	36~37
High Frequency Devices-Common Mode Filter 1210.....	38
Multilayer Chip Varistor (MLV) – VZ Series & VH Series .....	39~42

## 2.4 GHz Bluetooth/WLAN-Chip Antenna-RFANT5220110A□T

### How to Order

RF	ANT	522011	0	A	□	T
<b>Walsin</b> RF Device	<b>Product code</b> ANT : Antenna	<b>Dimension code</b> 522011 = Length = 52 Width = 20 Thickness = 11	<b>Unit of dimension</b> 0: 0.1 mm 1: 1.0 mm	<b>Application</b> A: 2.4GHz ISM Band	<b>Specification</b> Design Code	<b>Packing</b> T=7" Reeled G=10" Reeled B=Bulk X: SFC product

### Dimensions

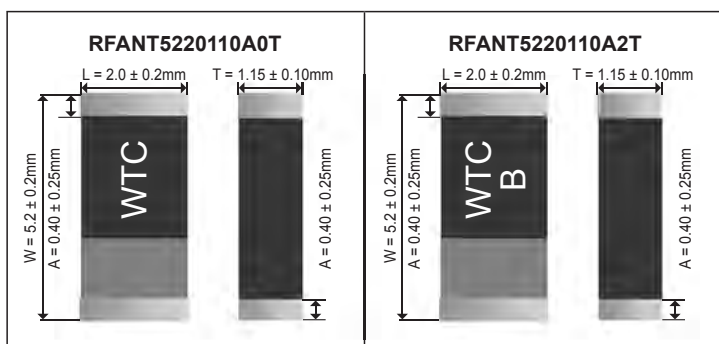

### RFANT5220110A□T Series

Item	Specification
Working Frequency Range	2.4 GHz ~ 2.5 GHz
Gain	2 dBi (Typical)
VSWR	2 max.
Polarization	Linear
Azimuth Bandwidth	Omni-directional
Impedance	50 Ω
Rated Power (max.)	3 Watts
Maximum Input Power	5 Watts for 5 minutes

### Typical Electrical Characteristics:

#### RFANT5220110A0T

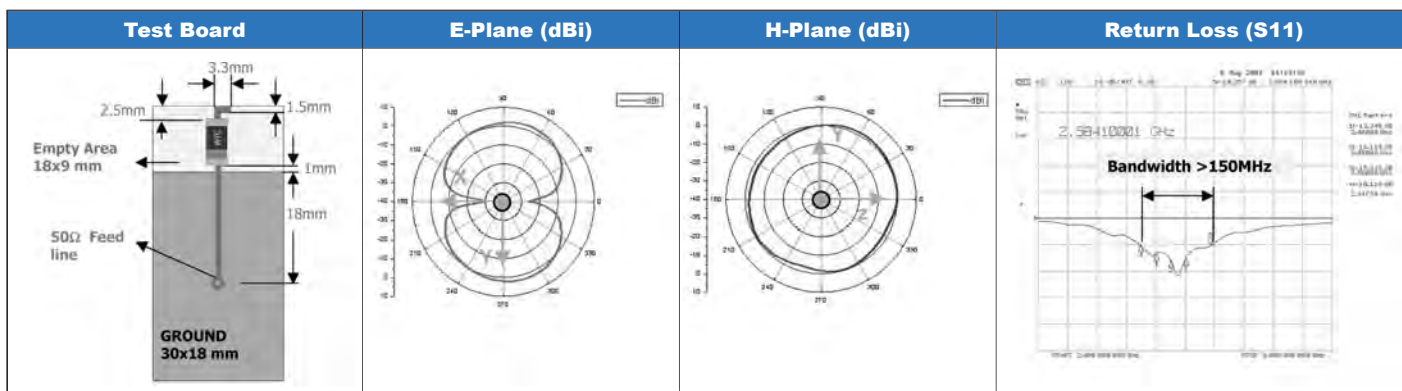

#### RFANT5220110A2T

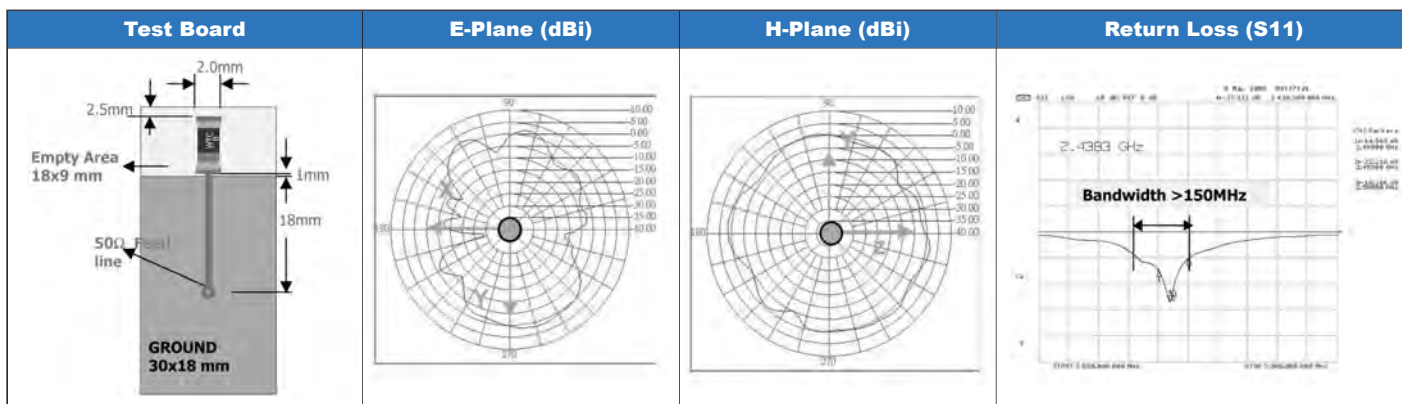

## ■ 2.4 GHz Bluetooth/WLAN-Chip Antenna-RFANT3216120A□T

### ■ How to Order

RF	ANT	321612	0	A	□	T
<b>Walsin</b> RF Device	<b>Product code</b> ANT : Antenna	<b>Dimension code</b> Per 2 digits of Length, Width, Thickness : e.g. : 321612 = Length32, Width 16, Thickness 12	<b>Unit of dimension</b> 0: 0.1 mm 1: 1.0 mm	<b>Application</b> A: 2.4GHz ISM Band	<b>Specification</b> Design Code	<b>Packing</b> T=7" Reeled G=10" Reeled B=Bulk X: SFC product

### ■ Dimensions

Symbol	Dimension
L	3.20 ± 0.20 mm
W	1.60 ± 0.10 mm
T	1.20 ± 0.10 mm
a	0.25 ± 0.15 mm

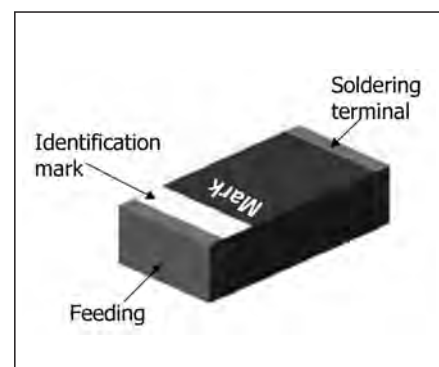
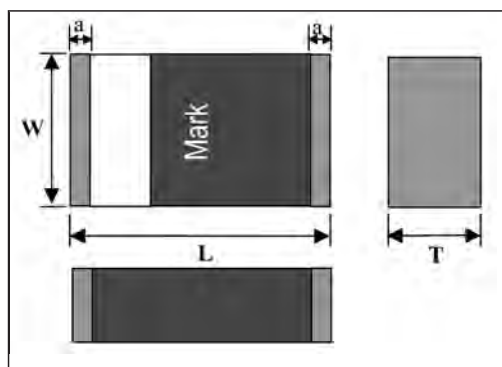

### ■ RFANT3216120A□T Series

Product code	RFANT3216120A1T	RFANT3216120A3T	RFANT3216120A5T
Working Frequency Range	2450 ± 50 MHz	2450 ± 50 MHz	2450 ± 50 MHz
Fc (GHz)	2.5	2.7	2.9
Gain (dBi)	2 (Typical)	2 (Typical)	2 (Typical)
Matching component value	Series 1	2.7 nH	6.8 nH
	Series 2	-	1.0 nH

### ■ Typical Electrical Characteristics(RFANT3216120A5T):

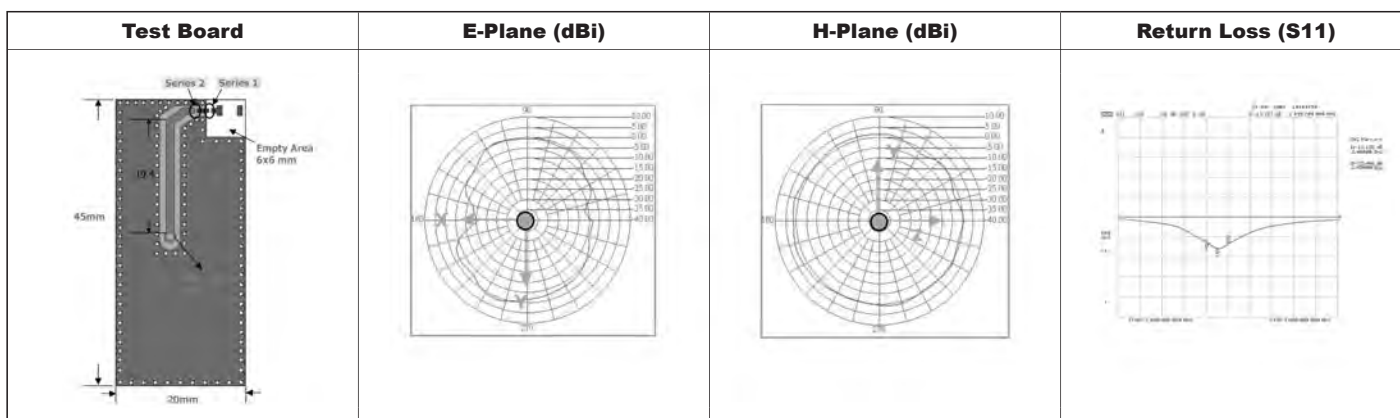



## ■ 2.4 GHz Bluetooth/WLAN-Chip Antenna-RGANT8010100A0T

### ■ How to Order

RG	ANT	801010	0	A	0	T
<b>Walsin</b>	<b>Product code</b>	<b>Dimension code</b>	<b>Unit of dimension</b>	<b>Application</b>	<b>Specification</b>	<b>Packing</b>
RG:RF /Pb free device	ANT : Antenna	Per 2 digits of Length, Width, Thickness : e.g. : 801010 = Length80, Width 10, Thickness 10	0: 0.1 mm 1: 1.0 mm	A: 2.4GHz ISM Band	Design Code	T=7" Reeled G=10" Reeled B=Bulk X: SFC product

### ■ Dimensions

Symbol	Dimension
L	8.00 ± 0.20 mm
W	1.00 ± 0.20 mm
T	1.00 ± 0.20 mm
A	0.50 ± 0.30 mm

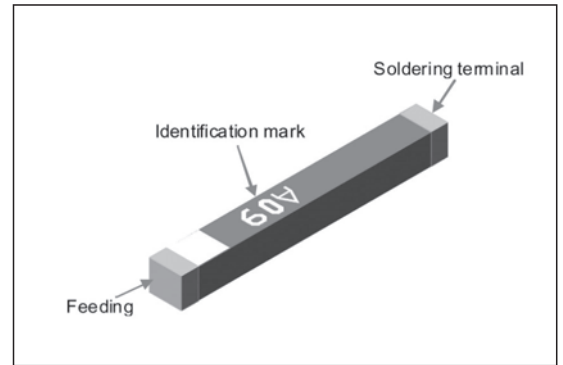
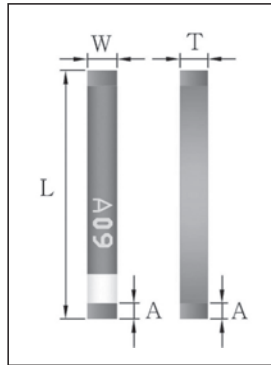

### ■ RGANT8010100A0T Series

Item	Specification
Working Frequency Range	2.4 GHz ~ 2.5 GHz
Gain	2 dBi (Typical)
VSWR	2 max
Polarization	Linear
Azimuth Bandwidth	Omni-directional
Impedance	50 Ω
Rated Power (max)	3 Watts
Maximum Input Power	5 Watts for 5 minutes
Operation Temperature	-40°C ~ +85°C

### ■ Typical Electrical Characteristics:

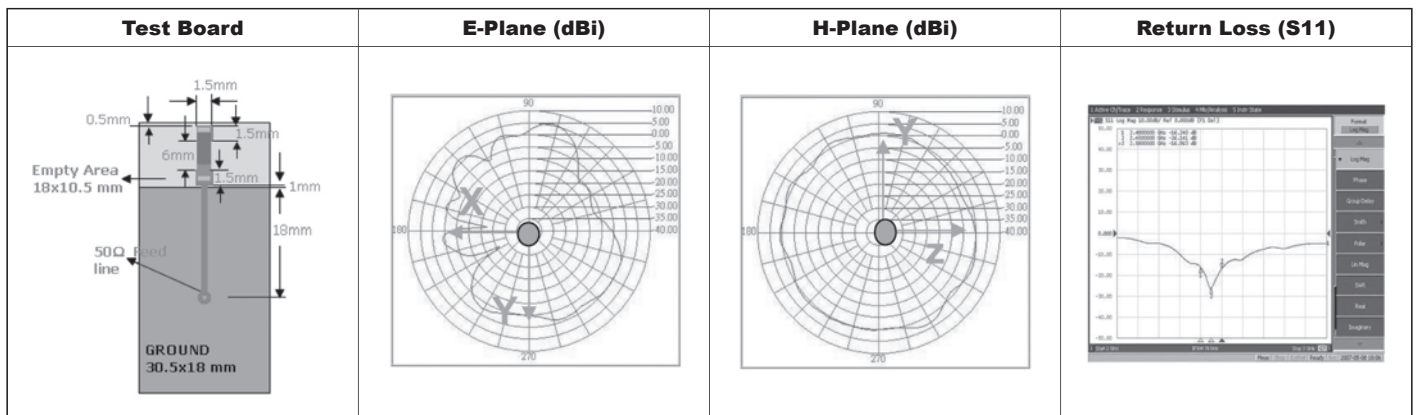

## ■ 2.4 GHz Bluetooth/WLAN-Free Antenna-RGFRA9937380A3T

### ■ How to Order

RG	FRA	993738	0	A	3	T
<b>Walsin</b> RG: RF Device /Pb free device	<b>Product code</b> FRA: Antenna	<b>Dimension code</b> Per 2 digits of Length, Width, Thickness : e.g. : 993738 = Length99, Width 37, Thickness 38	<b>Unit of dimension</b> 0: 0.1 mm 1: 1.0 mm	<b>Application</b> A: 2.4GHz ISM Band	<b>Specification</b> Design Code	<b>Packing</b> T=7" Reeled G=10" Reeled B=Bulk X: SFC product

### ■ Dimensions

Dimension	Port definition
L	-
W	-
T	-
P <sub>w</sub>	Pad width
P <sub>1</sub>	Soldering termination
P <sub>2</sub>	Feed termination
P <sub>3</sub>	Ground termination

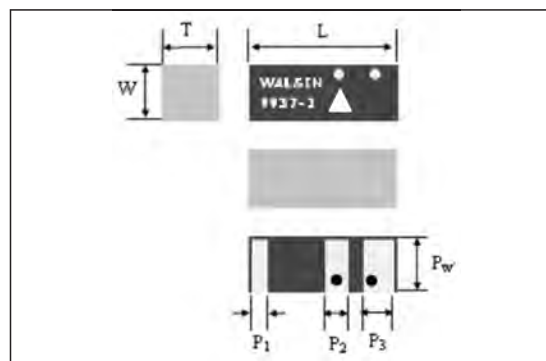

### ■ RGFRA9937380A3T Series

Item	Specification
Central Frequency (GHz)	Marking
	9937-3
	Frequency (GHz)
	2.55 GHz
Gain	2 dBi (Typical)
VSWR	2 max.
Polarization	Linear
Azimuth Bandwidth	Omni-directional
Impedance	50 Ω
Rated Power (max.)	1 Watts
Operation Temperature	-40°C ~ +85°C

### ■ Typical Electrical Characteristics:

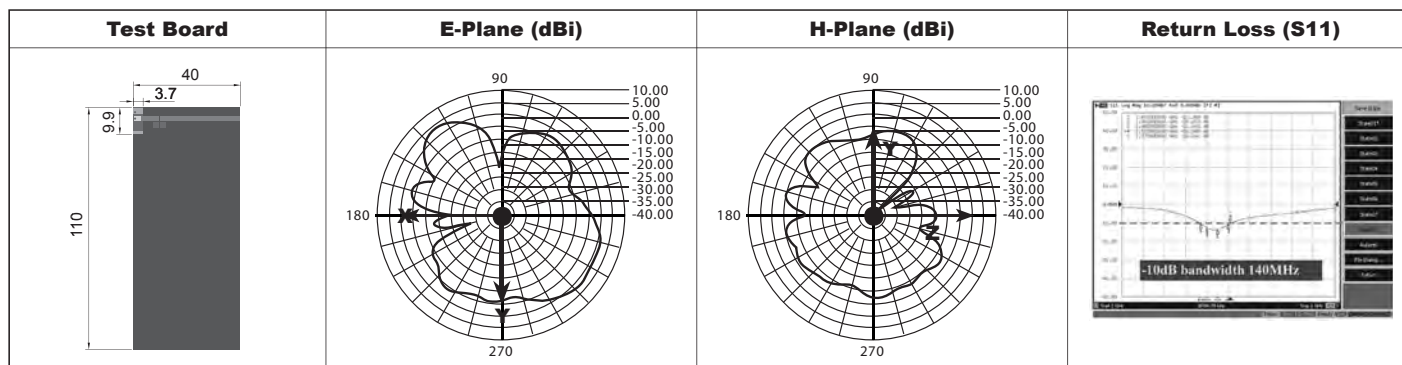

## ■ 2.4 GHz Bluetooth/WLAN-Free Antenna-RGFRA1903041A1T

### ■ How to Order

RG	FRA	190304	1	A	1	T
<b>Walsin</b> RG: RF / Pb free device	<b>Product code</b> FRA : Antenna	<b>Dimension code</b> Per 2 digits of Length, Width, Thickness : e.g. : 190304 = Length19, Width 3.0, Thickness 3.8	<b>Unit of dimension</b> 0: 0.1 mm 1: 1.0 mm	<b>Application</b> A: 2.4GHz ISM Band	<b>Specification</b> Design Code	<b>Packing</b> T=7" Reeled G=10" Reeled B=Bulk X: SFC product

### ■ Dimensions

Dimension	Port definition
L	19.0 ± 0.15 mm
W	3.0 ± 0.15 mm
T	3.8 ± 0.20 mm
P <sub>w</sub>	3.0 ± 0.10 mm Pad width
P <sub>1</sub>	1.0 ± 0.10 mm Soldering termination
P <sub>2</sub>	1.0 ± 0.10 mm Soldering termination
P <sub>3</sub>	1.0 ± 0.10 mm Feed termination
P <sub>4</sub>	1.0 ± 0.10 mm Ground termination

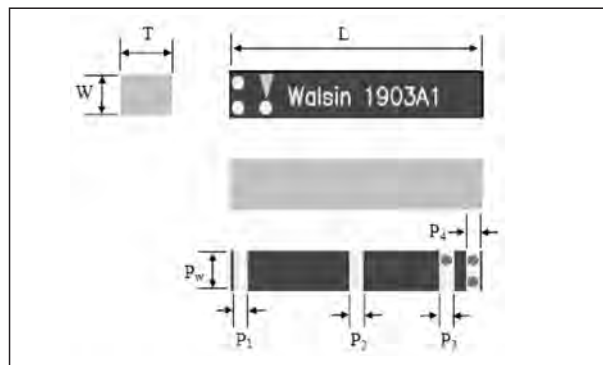

### ■ RGFRA1903041A1T Series

Item	Specification
Central Frequency	2.450 GHz
Gain	2 dBi (Typical)
VSWR	2 max.
Polarization	Linear
Azimuth Bandwidth	Omni-directional
Impedance	50 Ω
Rated Power (max.)	1 Watts
Operation Temperature	-40°C ~ +85°C

### ■ Typical Electrical Characteristics:

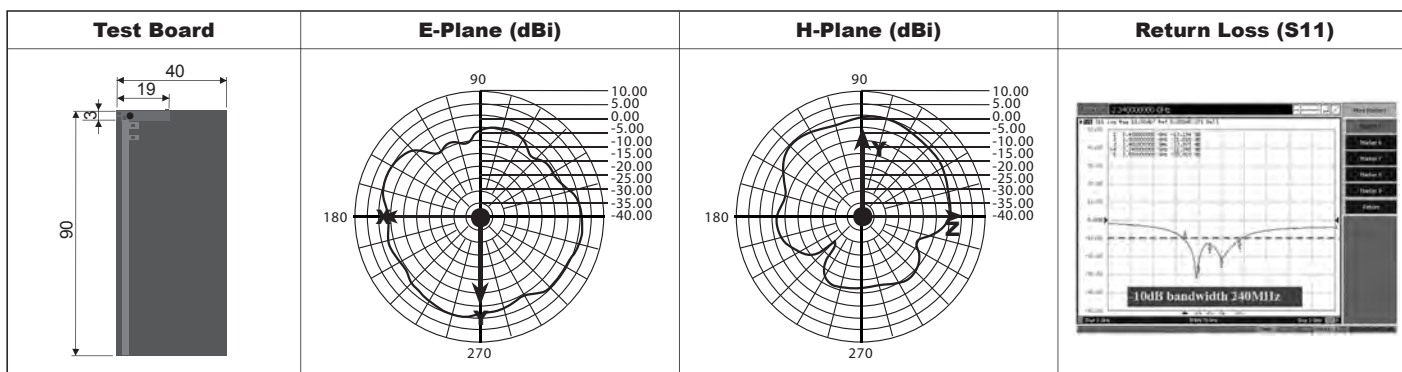



## 2.4 GHz High Frequency Devices-Band Pass Filter-RFBPF3225150A□T

### How to Order

RF	BPF	322515	0	A	□	T
<b>Walsin</b>	<b>Product code</b>	<b>Dimension code</b>	<b>Unit of dimension</b>	<b>Application</b>	<b>Specification</b>	<b>Packing</b>
RF Device	BPF : Band Pass Filter	322515 = Length = 32 Width = 25 Thickness = 15	0: 0.1 mm 1: 1.0 mm	A: 2.4GHz ISM Band	Design Code	T=7" Reeled G=10" Reeled B=Bulk X: SFC product

### Dimensions

Symbol	Dimension
L	3.20 ± 0.20 mm
W	2.50 ± 0.20 mm
T	1.50 ± 0.10 mm
A	0.40 ± 0.20 mm
B	0.60 ± 0.20 mm
C	0.70 ± 0.20 mm
D	0.20 ± 0.15 mm

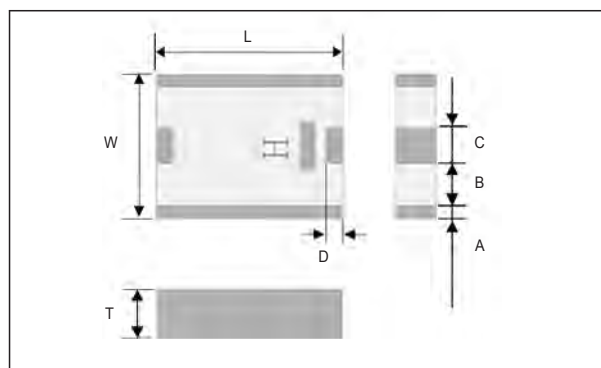

### RFBPF3225150A□T Series

Item	Specification	
	RFBPF3225150A4T	RFBPF3225150A5T
Frequency range (MHz)	2450 ± 50 MHz	2450 ± 50 MHz
Insertion Loss	2.0 dB (max)	1.8 dB (max)
VSWR	2.0 (max)	2.0 (max)
Impedance	50 Ω	50 Ω
Attenuation (min.)	30 dB @900 MHz	30 dB @900 MHz
	30 dB @1850 MHz	30 dB @1850 MHz
	20 dB @2100 MHz	20 dB @2100 MHz
	30 dB @4800 MHz	30 dB @4800 MHz

### Typical Electrical Characteristics:

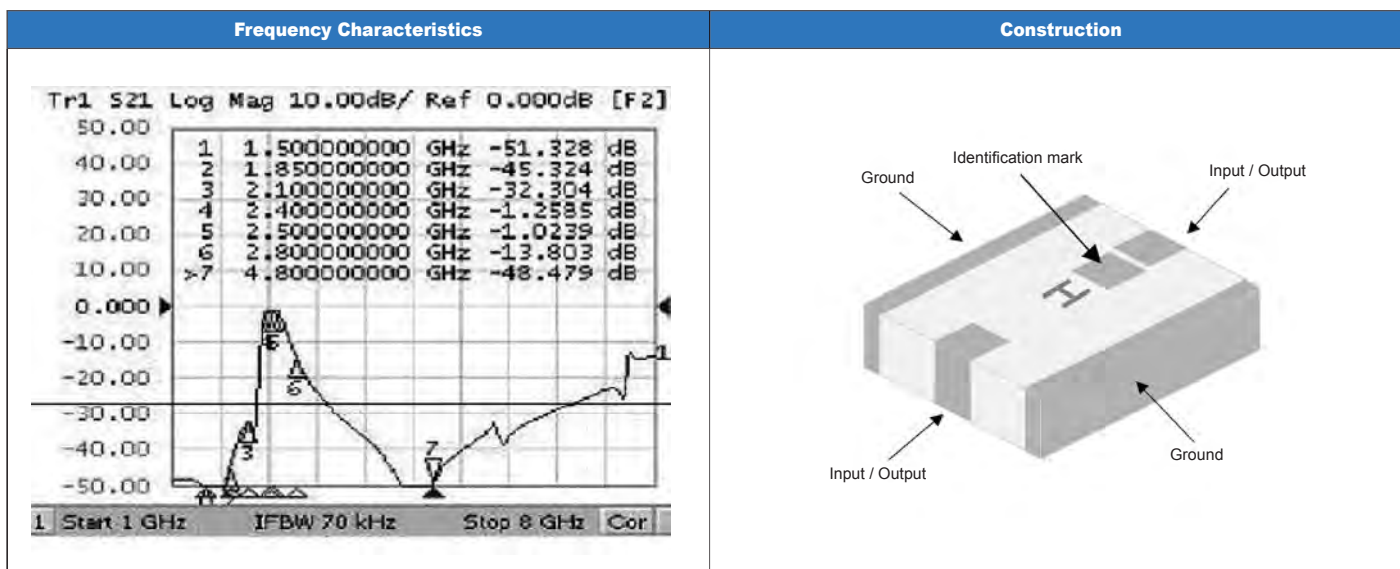

## 2.4 GHz High Frequency Devices-Band Pass Filter-RFBPF2520120A□T

### How to Order

RF	BPF	252012	0	A	□	T
<b>Walsin</b> RF Device	<b>Product code</b> BPF : Band Pass Filter	<b>Dimension code</b> Per 2 digits of Length, Width, Thickness : e.g. : 252012 = Length25, Width 20, Thickness 12	<b>Unit of dimension</b> 0: 0.1 mm 1: 1.0 mm	<b>Application</b> A: 2.4GHz ISM Band	<b>Specification</b> Design Code	<b>Packing</b> T=7" Reeled G=10" Reeled B=Bulk X: SFC product

### Dimensions

Symbol	Dimension
L	2.50 ± 0.20 mm
W	2.00 ± 0.20 mm
T	1.20 ± 0.10 mm
A	0.25 ± 0.20 mm
B	0.50 ± 0.20 mm
C	0.50 ± 0.20 mm

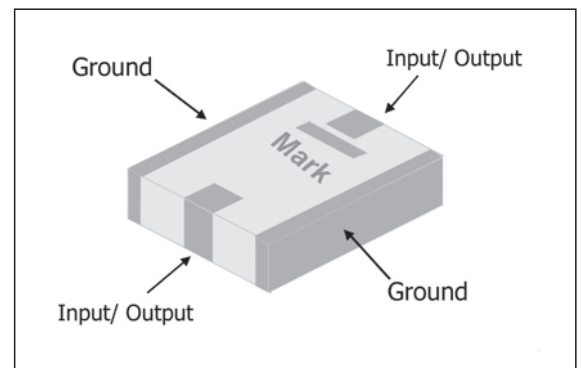
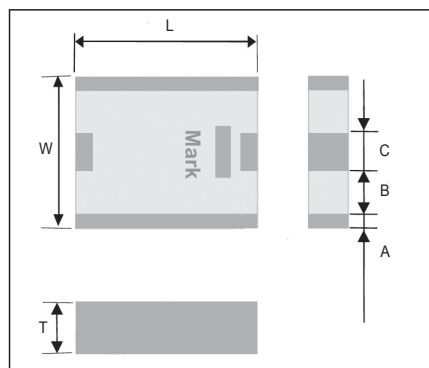

### RFBPF2520120A□T Series

Item	Specification			
	RFBPF2520120A1T	RFBPF2520120A2T	RFBPF2520120A3T	RFBPF2520120A4T
Frequency range (MHz)	2450 ± 50 MHz	2450 ± 50 MHz	2450 ± 50 MHz	2450 ± 50 MHz
Insertion Loss	1.7 dB (max)	2.1 dB (max)	1.2 dB (max)	1.7 dB (max)
VSWR	2.0 (max)	2.0 (max)	2.0 (max)	2.0 (max)
Impedance	50 Ω	50 Ω	50 Ω	50 Ω
Attenuation (min.)	30 dB @900 MHz 30 dB @1850 MHz 20 dB @2100 MHz 40 dB @4800 MHz 25 dB @7200 MHz	30 dB @900 MHz 30 dB @1850 MHz 30 dB @4800 MHz	30 dB @900 MHz 30 dB @1850 MHz 25 dB @4800 MHz	30 dB @900 MHz 30 dB @1850 MHz 30 dB @4800 MHz

### Typical Electrical Characteristics:

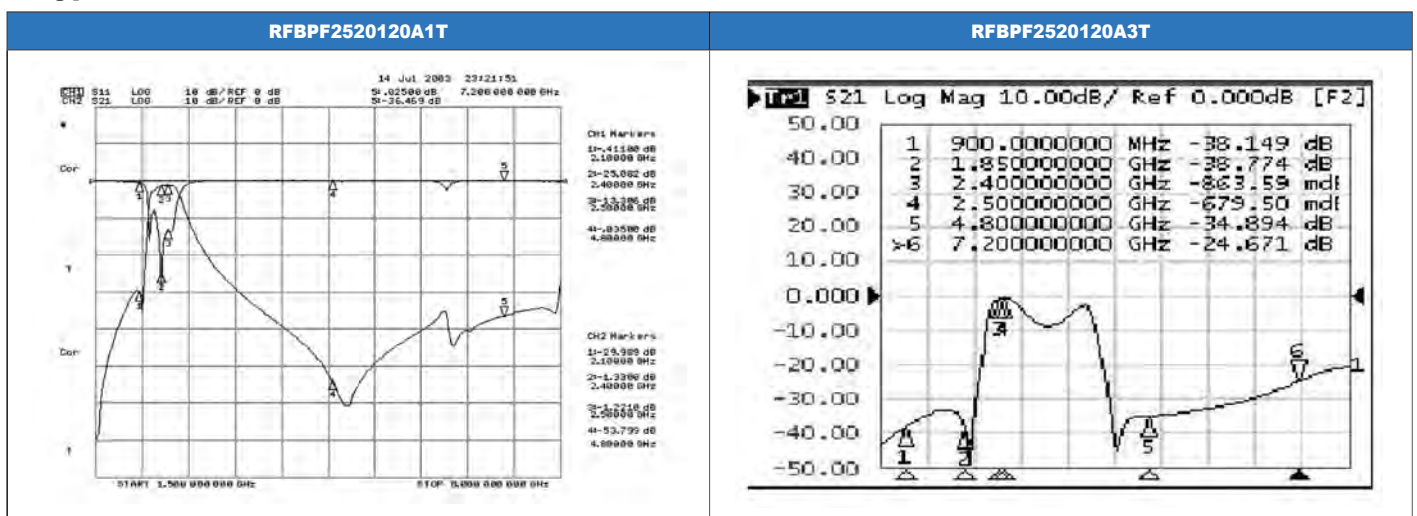

## 2.4 GHz High Frequency Devices-Band Pass Filter-RFBPF2520100A□T

### How to Order

RF	BPF	252010	0	A	□	T
<b>Walsin</b> RF Device	<b>Product code</b> BPF : Band Pass Filter	<b>Dimension code</b> Per 2 digits of Length, Width, Thickness : e.g. : 252010 = Length25, Width 20, Thickness 10	<b>Unit of dimension</b> 0: 0.1 mm 1: 1.0 mm	<b>Application</b> A: 2.4GHz ISM Band	<b>Specification</b> Design Code	<b>Packing</b> T=7" Reeled G=10" Reeled B=Bulk X: SFC product

### Dimensions

Symbol	RFBPF2520100A5T	RFBPF2520100A6T
L	2.50 ± 0.20 mm	2.50 ± 0.20 mm
W	2.00 ± 0.20 mm	2.00 ± 0.20 mm
T	1.00 ± 0.10 mm	1.05 ± 0.10 mm
A	0.20 ± 0.20 mm	0.25 ± 0.20 mm
B	0.50 ± 0.20 mm	0.50 ± 0.20 mm
C	0.50 ± 0.20 mm	0.50 ± 0.20 mm

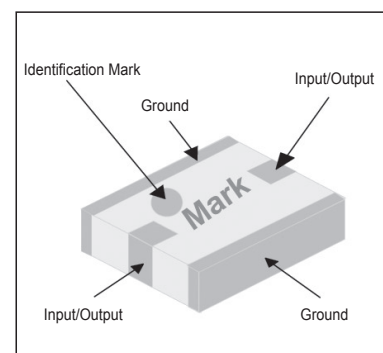
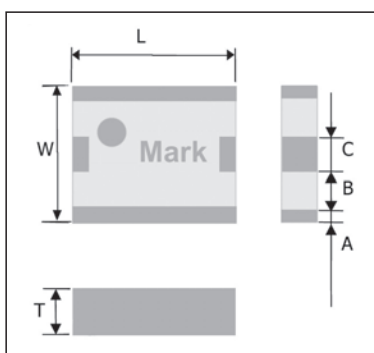

### RFBPF2520100A□T Series

Item	Specification	
	RFBPF2520100A5T	RFBPF2520100A6T
Frequency range (MHz)	2450 ± 50 MHz	2450 ± 50 MHz
Insertion Loss	2 dB max	1.4 dB max
VSWR	2.0 (max)	2.0 (max)
Impedance	50 Ω	50 Ω
Attenuation (min.)	40 dB @900 MHz 30 dB @1990 MHz 20 dB @2100 MHz 35 dB @3200 MHz 40 dB @4800 MHz 25dB @7200 MHz* (* for reference)	35 dB @1900 MHz 35 dB @4800 MHz

### Typical Electrical Characteristics:

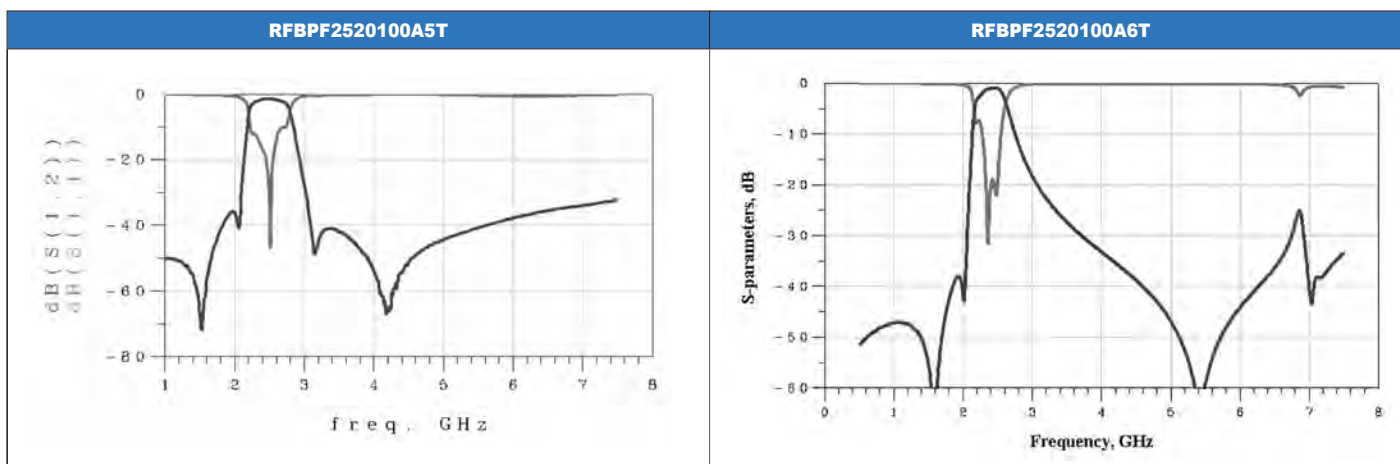

## ■ 2.4 GHz High Frequency Devices-Band Pass Filter-RFBPF2012090A1T

### ■ How to Order

RF	BPF	201209	0	A	1	T
<b>Walsin</b> Walsin RF Device	<b>Product code</b> BPF : Band Pass Filter	<b>Dimension code</b> Per 2 digits of Length, Width, Thickness : e.g. : 201209 = Length20, Width 12, Thickness 09	<b>Unit of dimension</b> 0: 0.1 mm 1: 1.0 mm	<b>Application</b> A: 2.4GHz ISM Band	<b>Specification</b> Design Code	<b>Packing</b> T=7" Reeled G=10" Reeled B=Bulk X: SFC product

### ■ Dimensions

Symbol	Dimension
L	2.00 ± 0.15 mm
W	1.25 ± 0.15 mm
T	0.90 ± 0.10 mm
A	1.00 ± 0.15 mm
B	0.30 ± 0.15 mm
C	0.50 ± 0.15 mm
D	0.25 ± 0.15 mm
E	0.25 ± 0.15 mm

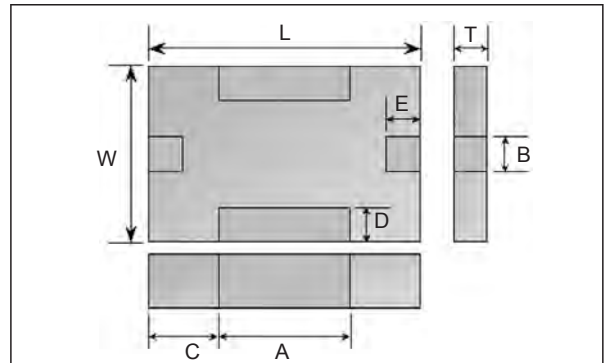

### ■ RFBPF2012090A1T Series

Item	Specification
Frequency range (MHz)	2450 ± 50 MHz
Insertion Loss	1.7 dB max
VSWR	2.0 (max)
Impedance	50 Ω
Attenuation (min.)	30 dB @900 MHz 20 dB @1850 MHz 30 dB @4800 MHz

### ■ Typical Electrical Characteristics:

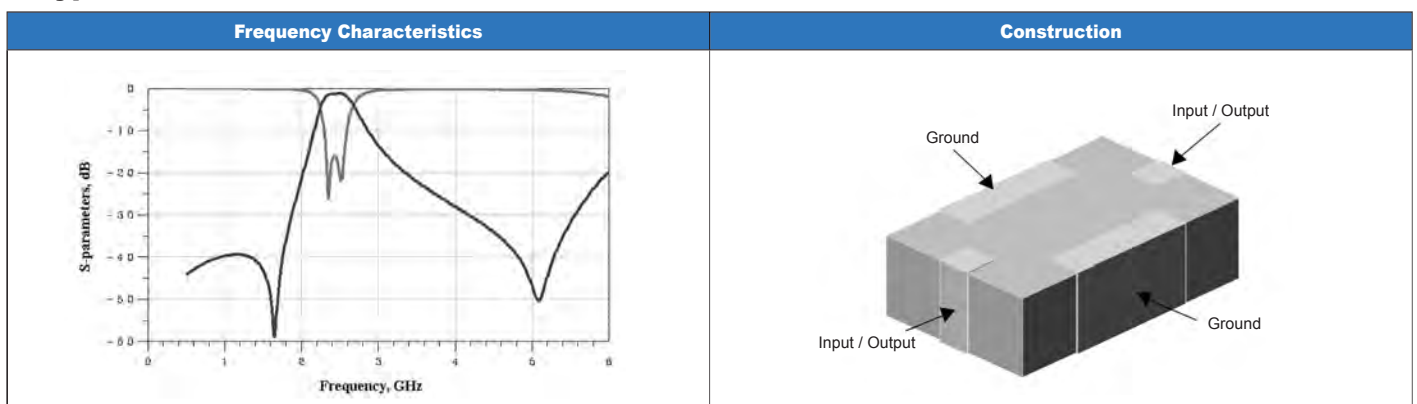

## 2.4 GHz High Frequency Devices-Band Pass Filter-RFBPF2012080A5T

### How to Order

RF	BPF	201208	0	A	5	T
<b>Walsin</b> RF Device	<b>Product code</b> BPF : Band Pass Filter	<b>Dimension code</b> Per 2 digits of Length, Width, Thickness : e.g. : 201208 = Length 20, Width 12, Thickness 08	<b>Unit of dimension</b> 0: 0.1 mm 1: 1.0 mm	<b>Application</b> A: 2.4GHz ISM Band	<b>Specification</b> Design Code	<b>Packing</b> T=7" Reeled G=10" Reeled B=Bulk X: SFC product

### Dimensions

Symbol	Dimension
L	2.0 ± 0.2 mm
W	1.2 ± 0.2 mm
T	0.8 ± 0.1 mm
A	0.4 ± 0.2 mm
B	0.4 ± 0.2 mm
C	0.4 ± 0.2 mm
D	0.2 ± 0.1 mm

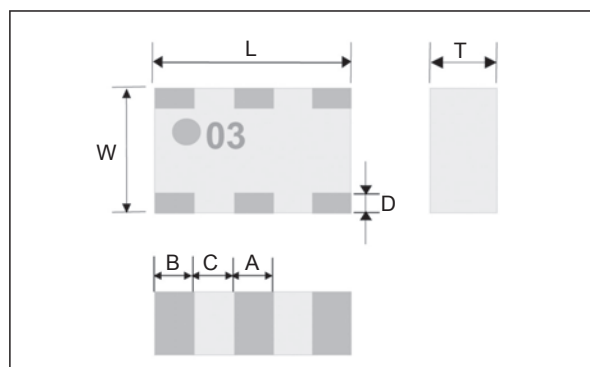

### RFBPF2012080A5T Series

Item	Specification
Frequency range (MHz)	2450 ± 50 MHz
Insertion Loss	3 dB (max)
VSWR	2.0 (max)
Impedance	50 Ω
Attenuation (min.)	40 dB @880~960 MHz 40 dB @1710~1990 MHz 20 dB @2110~2170 MHz 40 dB @4800~5000 MHz 30 dB @7200~7500 MHz

### Typical Electrical Characteristics:

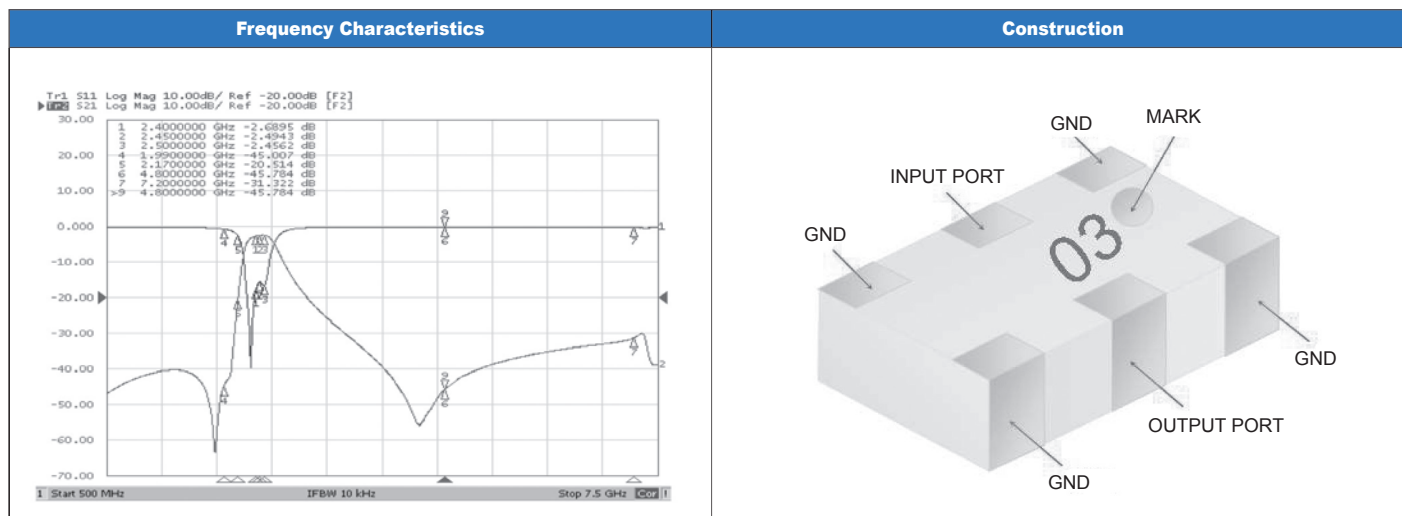

## ■ 2.4 GHz High Frequency Devices-Band Pass Filter-RFBPF2012080A7T

### ■ How to Order

RF	BPF	201208	0	A	7	T
<b>Walsin</b> RF Device	<b>Product code</b> BPF : Band Pass Filter	<b>Dimension code</b> Per 2 digits of Length, Width, Thickness : e.g. : 201208 = Length 20, Width 12, Thickness 08	<b>Unit of dimension</b> 0: 0.1 mm 1: 1.0 mm	<b>Application</b> A: 2.4GHz ISM Band	<b>Specification</b> Design Code	<b>Packing</b> T=7" Reeled G=10" Reeled B=Bulk X: SFC product

### ■ Dimensions

Symbol	Dimension
L	2.00 ± 0.15 mm
W	1.25 ± 0.15 mm
T	0.75 ± 0.10 mm
A	1.00 ± 0.15 mm
B	0.30 ± 0.15 mm
C	0.50 ± 0.15 mm
D	0.25 ± 0.15 mm
E	0.25 ± 0.15 mm

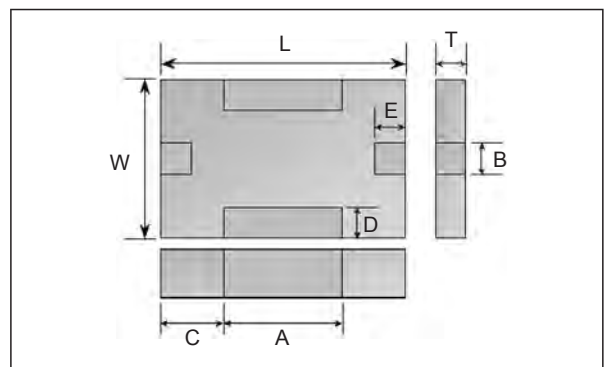

### ■ RFBPF2012080A7T Series

Item	Specification
Frequency range (MHz)	2450 ± 50 MHz
Insertion Loss	3 dB (max)
VSWR	2.0 (max)
Impedance	50 Ω
Attenuation (min.)	40 dB @DC~1600 MHz 18 dB @1600~2000 MHz 30 dB @3000~3100 MHz 35 dB @4800~5000 MHz 20 dB @7200~7500 MHz

### ■ Typical Electrical Characteristics:

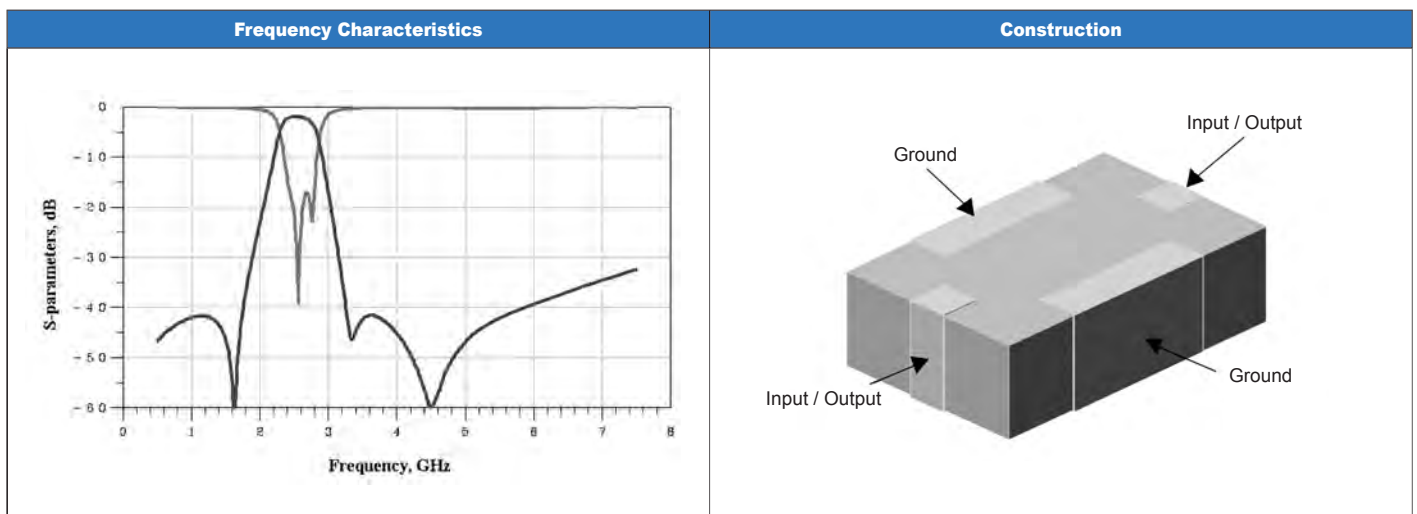



## 2.4 GHz High Frequency Devices-Band Pass Filter-RFBPF1608070A0T

### How to Order

RF	BPF	160807	0	A	0	T
<b>Walsin</b> RF Device	<b>Product code</b> BPF : Band Pass Filter	<b>Dimension code</b> Per 2 digits of Length, Width, Thickness : e.g. : 160807 = Length16, Width 08, Thickness 07	<b>Unit of dimension</b> 0: 0.1 mm 1: 1.0 mm	<b>Application</b> A: 2.4GHz ISM Band	<b>Specification</b> Design Code	<b>Packing</b> T=7" Reeled G=10" Reeled B=Bulk X: SFC product

### Dimensions

Symbol	Dimension
L	1.60 ± 0.15 mm
W	0.80 ± 0.15 mm
T	0.70 ± 0.10 mm
A	0.70 ± 0.15 mm
B	0.30 ± 0.15 mm
C	0.45 ± 0.15 mm
D	0.15 ± 0.10 mm
E	0.15 ± 0.10 mm

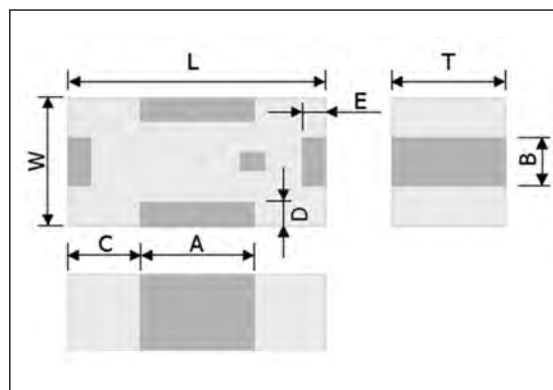

### RFBPF1608070A0T Series

Item	Specification
Frequency range (MHz)	2450 ± 50 MHz
Insertion Loss	2.5 dB (max)
VSWR	2.0 (max)
Impedance	50 Ω
Attenuation (min.)	30 dB @960 MHz 25 dB @1910 MHz 20 dB @1990 MHz 30 dB @4800 MHz 25 dB @7200 MHz

### Typical Electrical Characteristics:

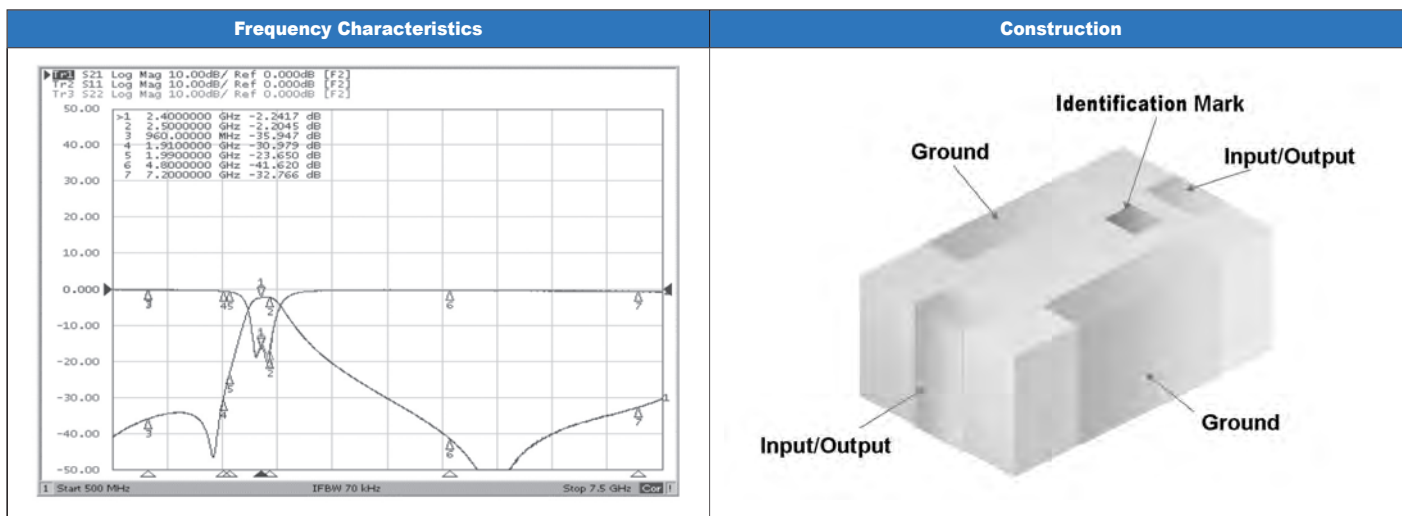

## 2.4 GHz High Frequency Devices-Balanced Filter-RFBPB2520120A□T

### How to Order

RF	BPB	252012	0	A	□	T
<b>Walsin</b> RF : device	<b>Product code</b> BPB : Balanced Type Band Pass Filter	<b>Dimension code</b> Per 2 digits of Length, Width, Thickness : e.g. : 252012 = Length25, Width 20, Thickness 12	<b>Unit of dimension</b> 0: 0.1 mm 1: 1.0 mm	<b>Application</b> A: 2.4GHz ISM Band	<b>Specification</b> Design Code	<b>Packing</b> T=7" Reeled G=10" Reeled B=Bulk X: SFC product

### Dimensions

Symbol	Dimension (mm)
L	2.50±0.2/-0.10
W	2.00±0.2/-0.10
T	1.20±0.1/-0.20
a	0.30 ± 0.20
c	1.00 ± 0.10
d	0.30 ± 0.20
P	0.80 ± 0.20

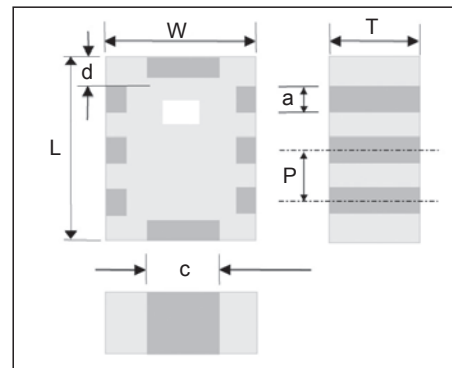

### RFBPB2520120A□T Series

Item	Specification	
	RFBPB2520120A1T	RFBPB2520120A2T
Frequency range (MHz)	2450 ± 50	2450 ± 50
Insertion Loss (dB)	2.0 max	2.2 max
VSWR	2.0 max	2.0 max
Impedance (Unbalanced)	50 Ω	50 Ω
Impedance (Balanced)	100 Ω	100 Ω
Phase Difference	180° ± 10°	180° ± 10°
Amplitude Difference	1.2 dB max	1.4 dB max
Attenuation ( dB min.)	25 @900 MHz 25 @1900 MHz 30 @4800 MHz 20 @7200 MHz (reference)	25 @900 MHz 25 @1900 MHz 30 @4800 MHz 15 @7200 MHz (reference)

### Typical Electrical Characteristics(RFBPB2520120A1T):

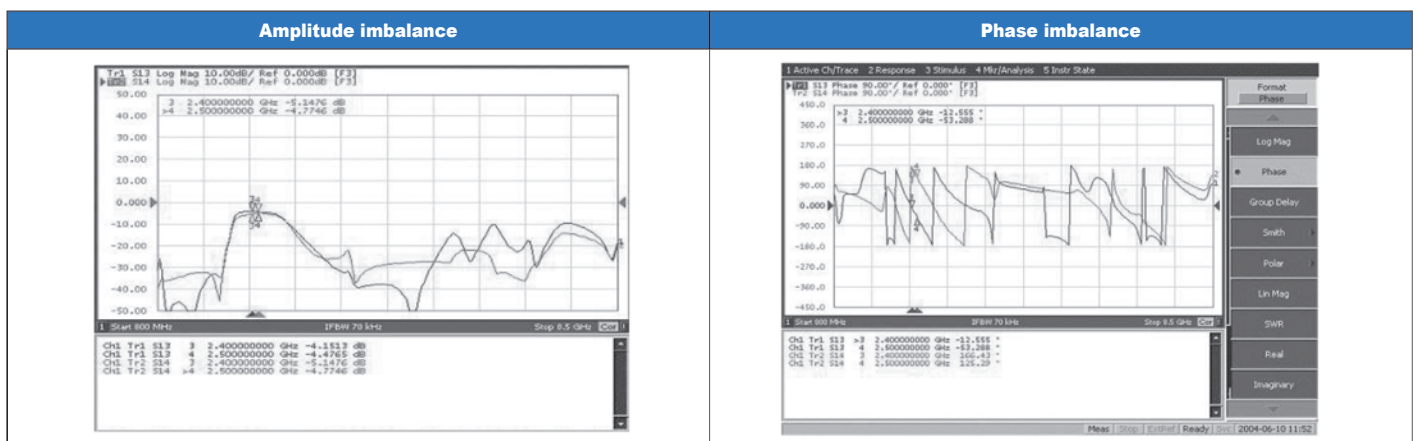

## 2.4 GHz High Frequency Devices-Balanced Filter-RGBPB2520090A□T

### How to Order

RG	BPB	252009	0	A	□	T
<b>Walsin</b>	<b>Product code</b>	<b>Dimension code</b>	<b>Unit of dimension</b>	<b>Application</b>	<b>Specification</b>	<b>Packing</b>
RG : RF /Pb free device	BPB : Balanced Type Band Pass Filter	Per 2 digits of Length, Width, Thickness : e.g. : 252009 = Length25, Width 20, Thickness 09	0: 0.1 mm 1: 1.0 mm	A: 2.4GHz ISM Band	Design Code	T=7" Reeled G=10" Reeled B=Bulk X: SFC product

### Dimensions

Symbol	Dimension
L	2.50 ± 0.20 mm
W	2.00 ± 0.20 mm
T	0.95 ± 0.10 mm
a	0.40 ± 0.10 mm
b	0.25 ± 0.10 mm
c	1.83 ± 0.10 mm
d	0.40 ± 0.10 mm
p	0.80 ± 0.20 mm

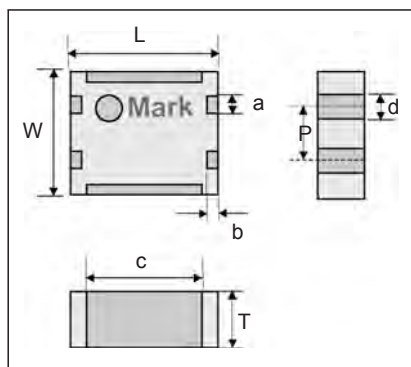

### Pin Arrangement

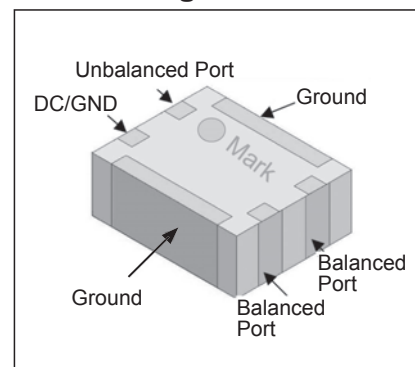

### RGBPB2520090A□T Series

Item	Specification	
	RGBPB2520090A5T	RGBPB2520090A6T
Frequency range (MHz)	2450 ± 50 MHz	2450 ± 50 MHz
Insertion Loss	3 dB max	3.5 dB max
VSWR	2.0 max	2.0 max
Impedance (Unbalanced)	50 Ω	50 Ω
Impedance (Balanced)	Match to BC series of Bluetooth chipset	Match to BC series of Bluetooth chipset
Phase Difference	180° ± 15°	180° ± 15°
Amplitude Difference	1.5 dB max	1.5 dB max
Attenuation ( min.)	40 dB @880~960 MHz 40 dB @1710~1880 MHz 20 dB @1880~1990 MHz 30 dB @4800~5000 MHz	40 dB @880~960 MHz 40 dB @1710~1880 MHz 20 dB @1880~1990 MHz 30 dB @4800~5000 MHz

### Typical Electrical Characteristics(RGBPB2520090A5T):

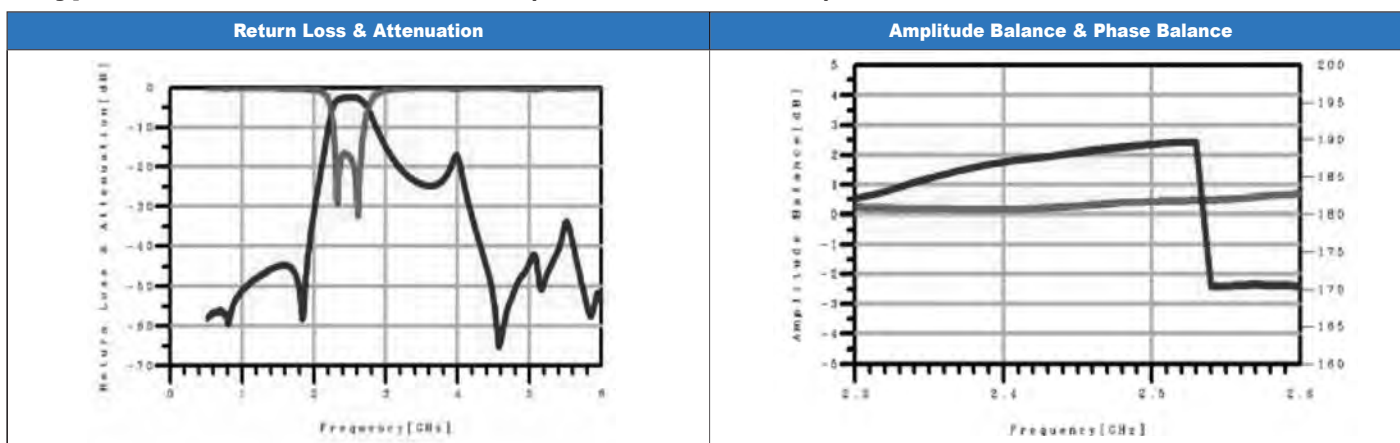

## 2.4 GHz High Frequency Devices-Balanced Filter-RFBPB2520090A7T

### How to Order

RF	BPB	252009	0	A	7	T
<b>Walsin</b>	<b>Product code</b>	<b>Dimension code</b>	<b>Unit of dimension</b>	<b>Application</b>	<b>Specification</b>	<b>Packing</b>
RF Device	BPB : Balanced Type Band Pass Filter	Per 2 digits of Length, Width, Thickness : e.g. : 252009 = Length25, Width 20, Thickness 09	0: 0.1 mm 1: 1.0 mm	A: 2.4GHz ISM Band	Design Code	T=7" Reeled G=10" Reeled B=Bulk X: SFC product

### Dimensions

Symbol	Dimension
L	2.50 ± 0.20
W	2.00 ± 0.20
T	0.85 ± 0.10
a	0.35 ± 0.20
b	0.4 ± 0.20
c	0.30 ± 0.20
d	0.70 ± 0.20
e	1.20 ± 0.20
f	0.15 (Typical)
g	0.15 (Typical)

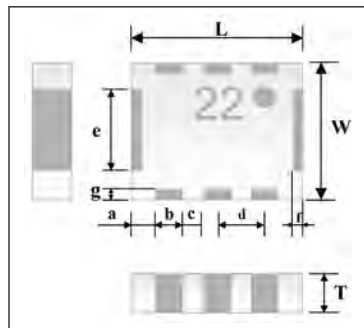

### Pin Arrangement

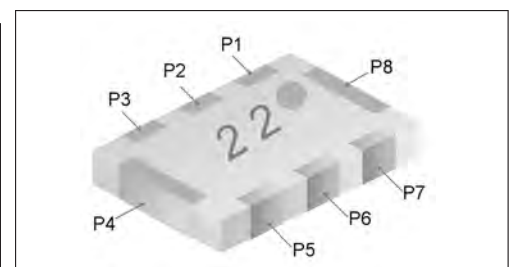

PIN	Definition	PIN	Definition
P1	NC	P5	Balanced Port
P2	Unbalanced Port	P6	Balanced Port
P3	DC	P7	GND
P4	GND	P8	GND

### RFBPB2520090A7T Series

Item	Specification
Frequency range (MHz)	2450 ± 50
Insertion Loss (dB)	3.5 max
VSWR	2.0 max
Impedance (Unbalanced)	50 Ω
Impedance (Balanced)	Conjugate match to BRF6150 of TI
Phase Difference	180° ± 15°
Amplitude Difference	1.5dB max
Attenuation ( dB min.)	35 @880-960 MHz 30 @1710-1880 MHz 25 @1880-1990 MHz 25 @4800-5000 MHz

### Typical Electrical Characteristics:

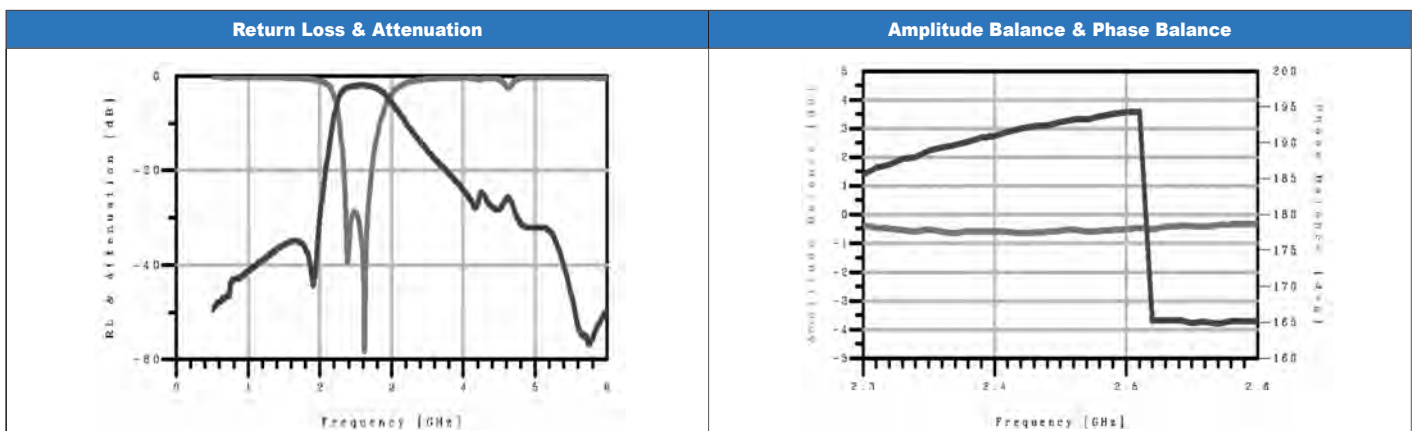

## 2.4 GHz High Frequency Devices-Balanced Filter-RFBPB2012110A5T

### How to Order

RF	BPB	201211	0	A	5	T
<b>Walsin</b>	<b>Product code</b>	<b>Dimension code</b>	<b>Unit of dimension</b>	<b>Application</b>	<b>Specification</b>	<b>Packing</b>
RF Device	BPB : Balanced Type Band Pass Filter	Per 2 digits of Length, Width, Thickness : e.g. : 201211 = Length 20, Width 12, Thickness 11	0: 0.1 mm 1: 1.0 mm	A: 2.4GHz ISM Band	Design Code	T=7" Reeled G=10" Reeled B=Bulk X: SFC product

### Dimensions

Symbol	Dimension (mm)
L	2.00 ± 0.15 mm
W	1.25 ± 0.10 mm
T	1.10 ± 0.10 mm
a	0.55 ± 0.10 mm
b	0.20 ± 0.15 mm
c	0.20 ± 0.15 mm
d	0.30 ± 0.10 mm
e	0.35 ± 0.10 mm
f	0.65 ± 0.10 mm

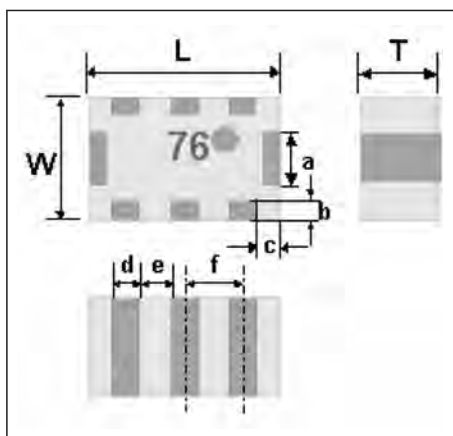

### Pin Arrangement

PIN	Definition	PIN	Definition
P1	Unbalanced Port	P5	Balanced Port
P2	DC or GND	P6	GND
P3	NC	P7	Balanced Port
P4	GND	P8	GND

### RFBPB2012110A5T Series

Item	Specification
Frequency range	2450 ± 50 MHz
Insertion Loss	2.8 dB max
VSWR	2.0 max
Impedance (Unbalanced)	50 Ω
Impedance (Balanced)	Conjugate match to BC series of Bluetooth chipset
Phase Difference	180° ± 10°
Amplitude Difference	2.0 dB max
Attenuation ( min.)	30dB @880~960 MHz 30dB @1710~1880 MHz 20dB @1880~1990 MHz 30dB @4800~5000 MHz

### Typical Electrical Characteristics:

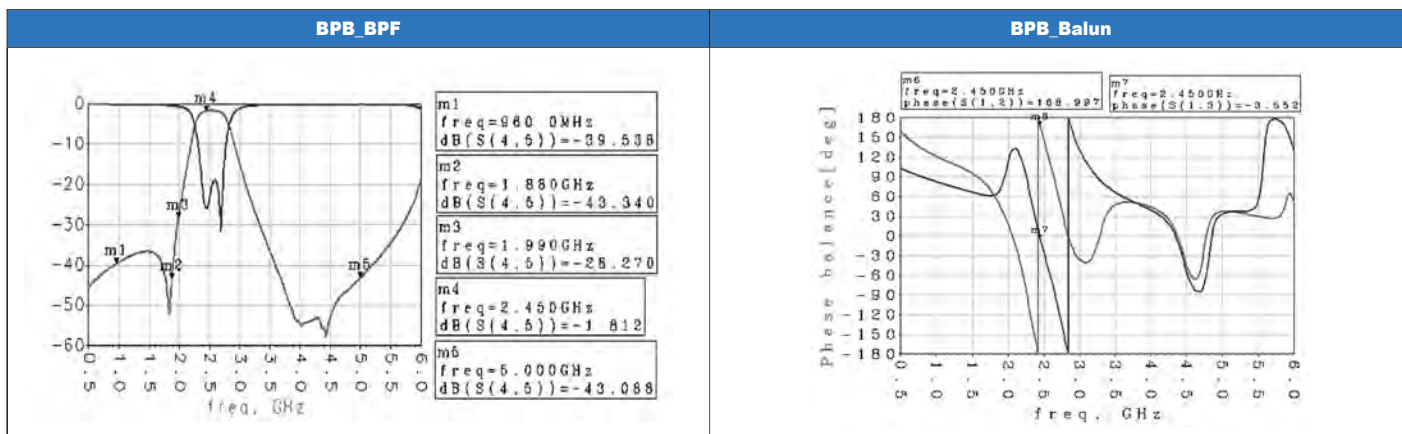

## 2.4 GHz High Frequency Devices-Balanced Filter-RFBPB2012100A□T

### How to Order

RF	BPB	201210	0	A	□	T
<b>Walsin</b>	<b>Product code</b>	<b>Dimension code</b>	<b>Unit of dimension</b>	<b>Application</b>	<b>Specification</b>	<b>Packing</b>
RF Device	BPB : Balanced Type Band Pass Filter	Per 2 digits of Length, Width, Thickness : e.g. : 201210 = Length 20, Width 12, Thickness 10	0: 0.1 mm 1: 1.0 mm	A: 2.4GHz ISM Band	Design Code	T=7" Reeled G=10" Reeled B=Bulk X: SFC product

### Dimensions

Symbol	Dimension (mm)
L	2.00 ± 0.15 mm
W	1.25 ± 0.10 mm
T	1.00 ± 0.10 mm
A	0.20 ± 0.15 mm
B	0.30 ± 0.10 mm
C	0.35 ± 0.10 mm
D	0.65 ± 0.10 mm
E	0.20 ± 0.10 mm
F	0.50 ± 0.10 mm

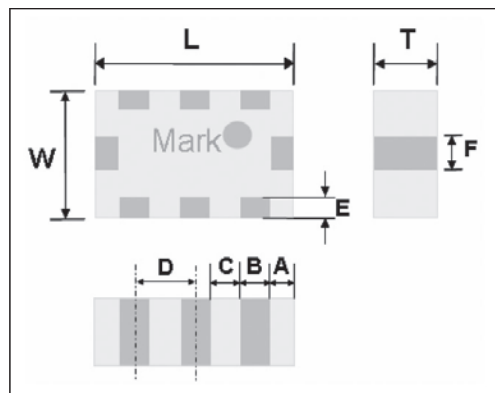

### Pin Arrangement

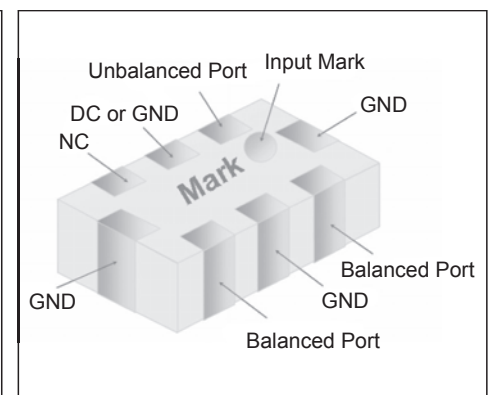

### RFBPB2012100A□T Series

Item	RFBPB2012100A1T	RFBPB2012100A6T
Frequency range (MHz)	2450 ± 50	2450 ± 50
Insertion Loss (dB)	3.5 max	3.5 max
VSWR	2.0 max	2.0 max
Impedance (Unbalanced)	50 Ω	50 Ω
Impedance (Balanced)	Conjugate match to BC series of Bluetooth chipset	Conjugate match to BC series of Bluetooth chipset
Phase Difference	180° ± 10°	180° ± 10°
Amplitude Difference	2 dB max	2.0 dB max
Attenuation (dB min.)	40 dB @880~960 MHz 35 dB @1710~1880 MHz 40 dB @1880~1900 MHz 35 dB @1900~1990 MHz 15 dB @2110~2170 MHz 30 dB @4800~5000 MHz	35 dB @880~960 MHz 30 dB @1710~1880 MHz 20 dB @1880~1900 MHz 40 dB(Min) @4800~5000 MHz

### Type Electrical Characteristics (RFBPB2012100A6T):

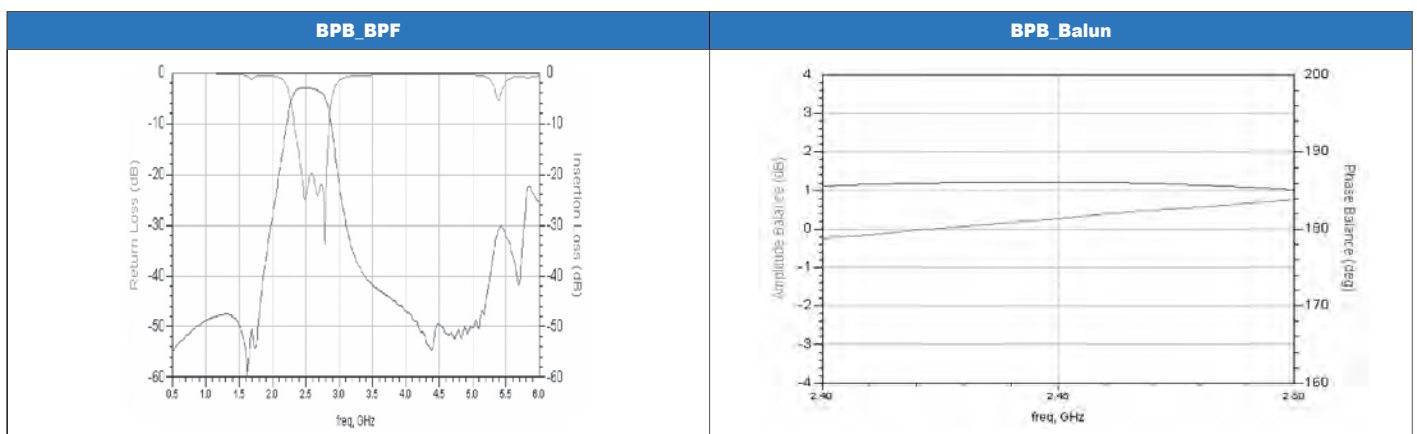



## 2.4 GHz High Frequency Devices-Balanced Filter - RFBPB2012090A□T

### How to Order

RF	BPB	201209	0	A	□	T
<b>Walsin</b>	<b>Product code</b>	<b>Dimension code</b>	<b>Unit of dimension</b>	<b>Application</b>	<b>Specification</b>	<b>Packing</b>
RF Device	BPB : Balanced Type Band Pass Filter	Per 2 digits of Length, Width, Thickness : e.g. : 201209 = Length20, Width 12, Thickness 9	0: 0.1 mm 1: 1.0 mm	A: 2.4GHz ISM Band	Design Code	T=7" Reeled G=10" Reeled B=Bulk X: SFC product

### Dimensions

Symbol	Dimension (mm)
L	2.00 ± 0.15
W	1.25 ± 0.10
T	0.90 ± 0.10
a	0.30 ± 0.10
b	0.20 ± 0.15
c	0.20 ± 0.15
d	0.35 ± 0.10
e	0.65 ± 0.10

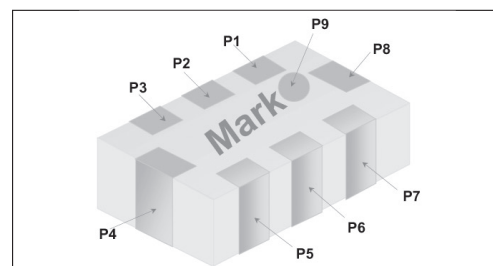
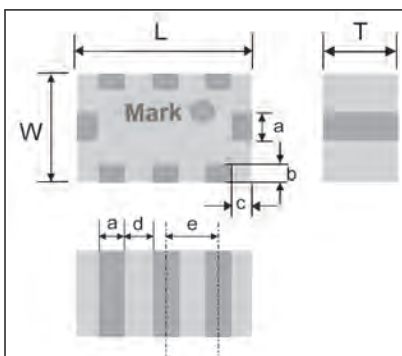

PIN	Definition	PIN	Definition
P1	Unbalanced Port	P5	Balanced Port
P2	DC or GND	P6	GND
P3	NC	P7	Balanced Port
P4	GND	P8	GND

### RFBPB2012090A□T Series

Item	RFBPB2012090A1T (Mark:41)	RFBPB2012090A3T (Mark:97)	RFBPB2012090A9T (Mark:93)
Frequency range (MHz)	2450 ± 50	2450 ± 50	2450 ± 50
Insertion Loss (dB)	3.5 dB max	3.5 dB max	2.8 dB max
VSWR	2.1 max	2.1 max	2.1 max
Impedance (Unbalanced)	50 Ω	50 Ω	50 Ω
Impedance (Balanced)	Conjugate match to BC series of Bluetooth chipset	Conjugate match to BC series of Bluetooth chipset	Conjugate match to BC series of Bluetooth chipset
Phase Difference	180° ± 10°	180° ± 10°	180° ± 10°
Amplitude Difference	2.0 dB max	2.0 dB max	2.0 dB max
Attenuation ( dB min.)	35dB @ 880~960 MHz 30dB @ 1710~1880 MHz 20dB @ 1880~1990 MHz 30dB @ 4800~5000 MHz	35dB @ 880~960 MHz 30dB @ 1710~1880 MHz 20dB @ 1880~1990 MHz 30dB @ 4800~5000 MHz	35dB @ 880~960 MHz 25dB @ 1710~1880 MHz 30dB @ 4800~5000 MHz

### Typical Electrical Characteristics:

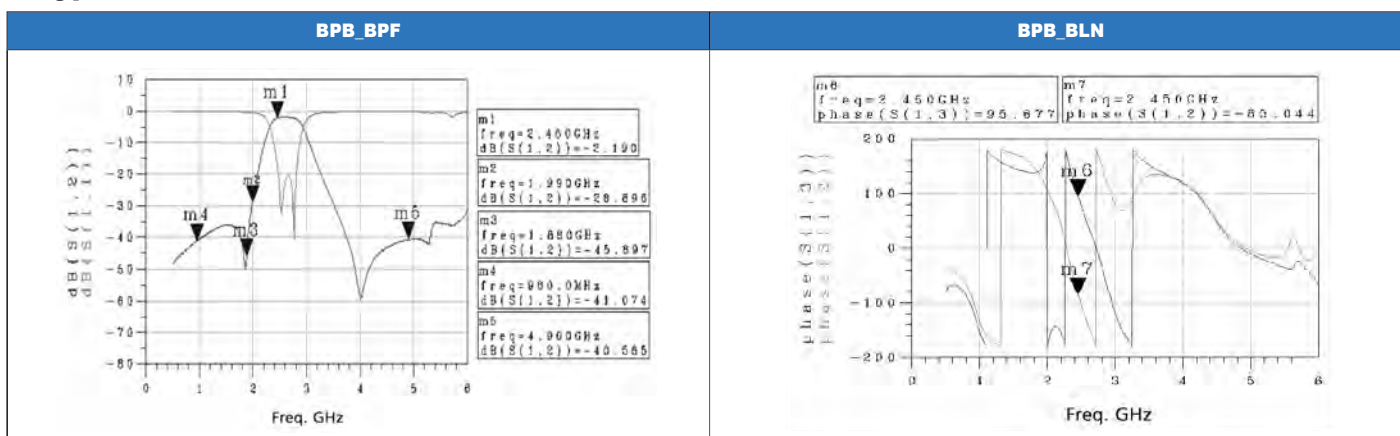

## 2.4 GHz High Frequency Devices-Balanced Filter-RFBPB2012060A1T

### How to Order

RF	BPB	201206	0	A	1	T
<b>Walsin</b>	<b>Product code</b>	<b>Dimension code</b>	<b>Unit of dimension</b>	<b>Application</b>	<b>Specification</b>	<b>Packing</b>
RF Device	BPB : Balanced Type Band Pass Filter	Per 2 digits of Length, Width, Thickness : e.g. : 201206 = Length 20, Width 12, Thickness 06	0: 0.1 mm 1: 1.0 mm	A: 2.4GHz ISM Band	Design Code	T=7" Reeled G=10" Reeled B=Bulk X: SFC product

### Dimensions

Symbol	Dimension (mm)
L	2.00 ± 0.15 mm
W	1.25 ± 0.10 mm
T	0.60 ± 0.10 mm
A	0.20 ± 0.15 mm
B	0.30 ± 0.10 mm
C	0.35 ± 0.10 mm
D	0.65 ± 0.10 mm
E	0.20 ± 0.10 mm
F	0.50 ± 0.10 mm

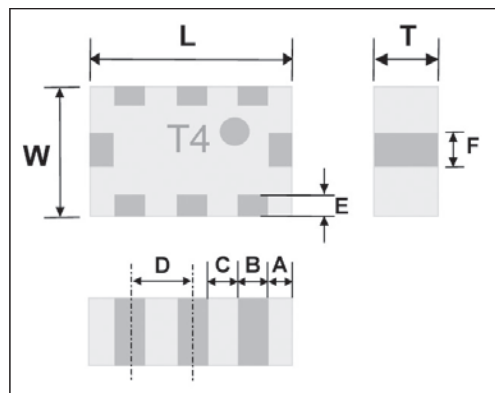

### Pin Arrangement

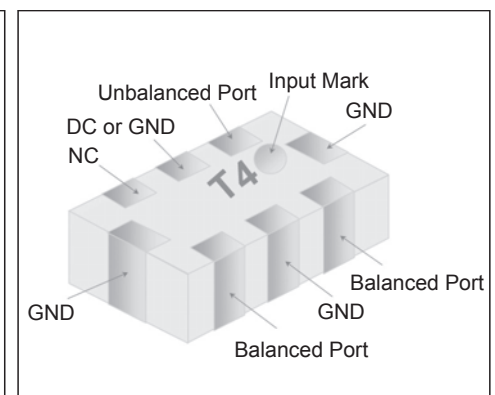

### RFBPB2012060A1T Series

Item	Specification
Frequency range (MHz)	2450 ± 50
Insertion Loss (dB)	3.5 max
VSWR	2.0 max
Impedance (Unbalanced)	50 Ω
Impedance (Balanced)	Conjugate match to BC series of CSR
Phase Difference	180° ± 10°
Amplitude Difference	2 dB max
Attenuation ( dB min.)	35 dB @880~960 MHz 30 dB @1710~1880 MHz 25 dB @1880~1900 MHz 20 dB @1900~1990 MHz 30 dB @4800~5000 MHz

### Type Electrical Characteristics:

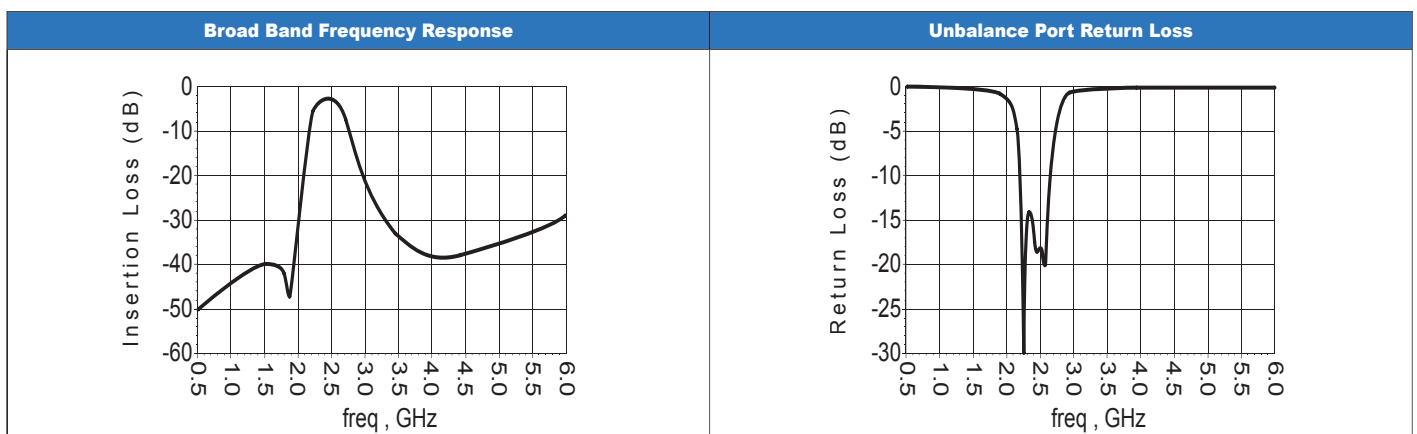

## 2.4 GHz High Frequency Devices-Low Pass Filter-RFLPF2012110A0T

### How to Order

RF	LPF	201211	0	A	0	T
<b>Walsin</b>	<b>Product code</b>	<b>Dimension code</b>	<b>Unit of dimension</b>	<b>Application</b>	<b>Specification</b>	<b>Packing</b>
RF Device	LPF : Low Pass Filter	201211 = Length = 20, Width = 12, Thickness = 11	0: 0.1 mm 1: 1.0 mm	A: 2.4GHz ISM Band	Design Code	T=7" Reeled G=10" Reeled B=Bulk X: SFC product

### Dimensions

Symbol	Dimension
L	2.00 ± 0.15 mm
W	1.25 ± 0.10 mm
T	1.05 ± 0.10 mm
A	0.30 ± 0.10 mm
B	0.30 ± 0.10 mm
C	0.30 ± 0.10 mm
D	0.40 ± 0.20 mm
E	0.30 ± 0.10 mm
F	0.20 ± 0.10 mm
P	0.65 ± 0.10 mm

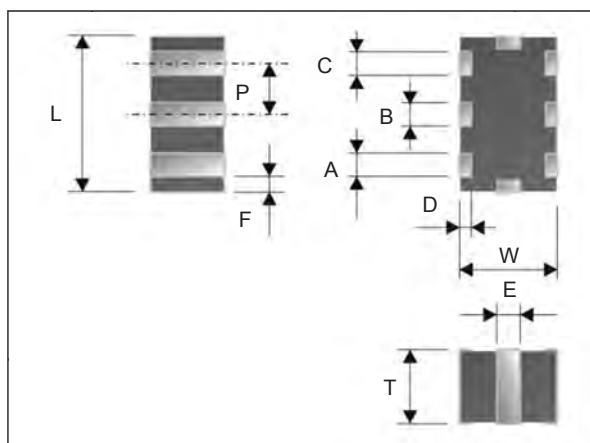

### RFLPF2012110A0T Series

Item	Specification
Frequency range (MHz)	2450 ± 50
Insertion Loss (dB)	0.7 (max)
VSWR	1.5
Attenuation (dB min.)	30 @ 2 x (fo ± BW/2) 25 @ 3 x (fo ± BW/2)

### Typical Electrical Characteristics:

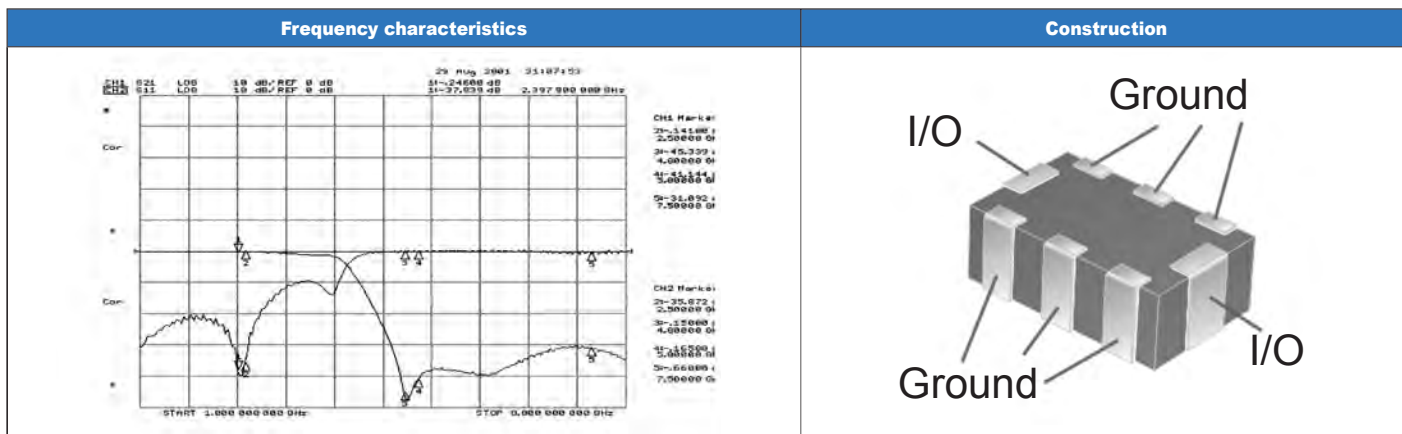

## 2.4 GHz High Frequency Devices-Balun-RFBLN2012090A□T

### How to Order

RF	BLN	201209	0	A	□	T
<b>Walsin</b> RF Device	<b>Product code</b> BLN : BALUN	<b>Dimension code</b> 201209 = Length = 20, Width = 12, Thickness = 09	<b>Unit of dimension</b> 0: 0.1 mm 1: 1.0 mm	<b>Application</b> A: 2.4GHz ISM Band	<b>Specification</b> Design Code	<b>Packing</b> T=7" Reeled G=13" Reeled B=Bulk X: SFC product

### Dimensions

Symbol	Dimension	Terminals	Connection
L	2.00 ± 0.15 mm	1	Unbalanced port
W	1.25 ± 0.15 mm	2	Ground or DC feed
t	0.95 ± 0.10 mm	3	Balanced port
a	0.20 ± 0.20 mm	4	Balanced port
b	0.30 ± 0.20 mm	5	Ground
c	0.35 ± 0.20 mm	6	Non Connection
d	0.65 ± 0.20 mm	-	-

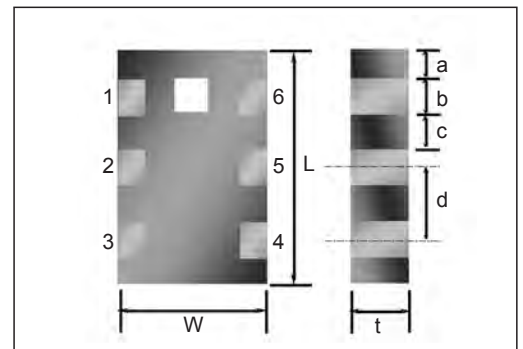

### RFBLN2012090A□T Series

Part Number.	Frequency(MHz)	Impedance (Ω)		Return Loss (dB) Min.	Inband Amplitude imbalance (dB) Max.	Inband Phase imbalance (degree)	Insertion Loss (dB)
		Unbalanced	Balanced				
RFBLN2012090A0T	2450 ± 50	50	50	10	2.0	180 ± 10	1.2
RFBLN2012090A1T	2450 ± 50	50	100	10	2.0	180 ± 10	1.0
RFBLN2012090A2T	2450 ± 50	50	200	10	2.0	180 ± 10	1.0

### Typical Electrical Characteristics (RFBLN2012090A1T):

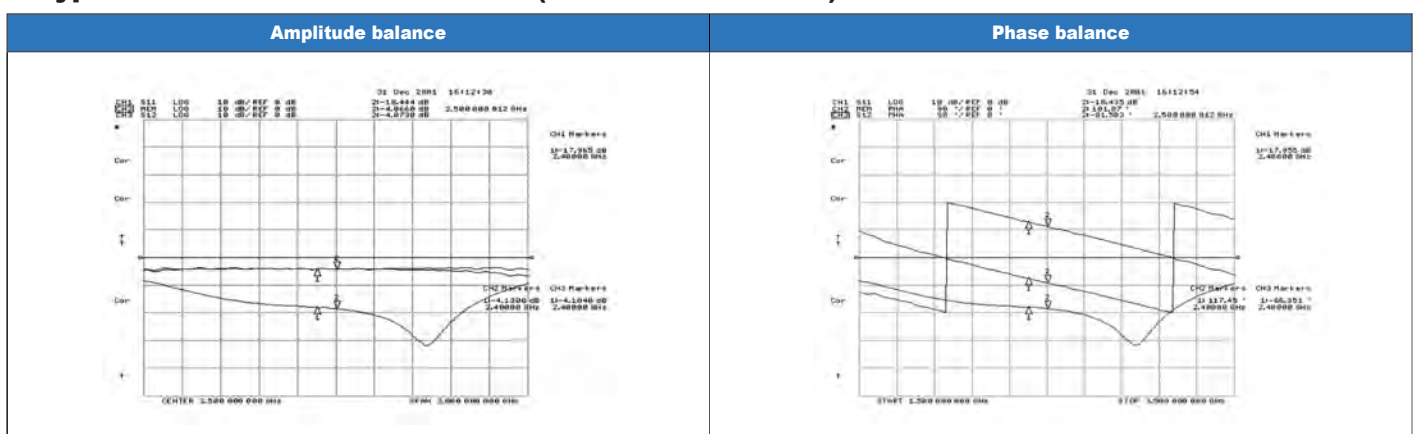

## 2.4 GHz High Frequency Devices-Balun-RGBLN2012080A4T

### How to Order

RG	BLN	201208	0	A	4	T
<b>Walsin</b> RG: RF /Pb free device	<b>Product code</b> BLN : BALUN	<b>Dimension code</b> Per 2 digits of Length, Width, Thickness : e.g. : 201208 = Length20, Width 12, Thickness 08	<b>Unit of dimension</b> 0: 0.1 mm 1: 1.0 mm	<b>Application</b> A: 2.4GHz ISM Band	<b>Specification</b> Design Code	<b>Packing</b> T=7" Reeled G=13" Reeled B=Bulk X: SFC product

### Dimensions

Symbol	Dimension	Terminals	Connection
L	2.00 ± 0.15 mm	1	Unbalanced port
W	1.25 ± 0.15 mm	2	Ground or DC feed
T	0.80 ± 0.10 mm	3	Balanced port
A	0.20 ± 0.20 mm	4	Balanced port
B	0.30 ± 0.20 mm	5	Ground
C	0.35 ± 0.20 mm	6	Non Connection
D	0.65 ± 0.20 mm	-	-

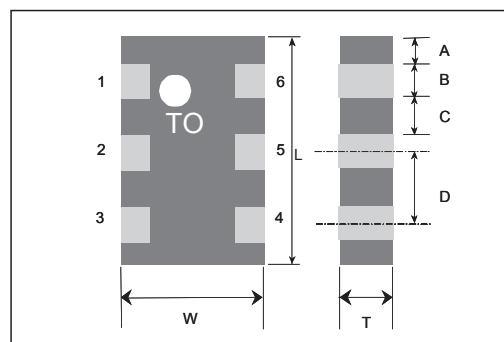

### RGLN2012080A4T Series

Part Number.	Frequency(MHz)	Impedance (Ω)		Return Loss (dB) Min.	Inband Amplitude imbalance (dB) Max.	Inband Phase imbalance (degree)	Insertion Loss (dB)
		Unbalanced	Balanced				
RGLN2012080A4T	2450 ± 50	50	50	10	2.0	180 ± 10	1.5

### Typical Electrical Characteristics:

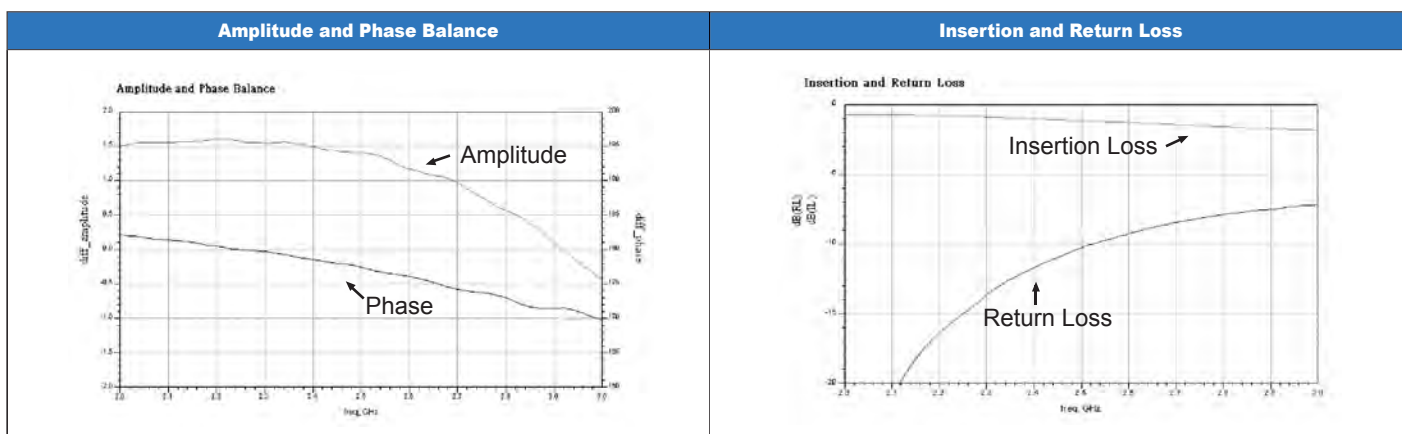

## 2.4 GHz High Frequency Devices-Balun-RGBLN1608070A1T

### How to Order

RG	BLN	160807	0	A	1	T
<b>Walsin</b> RG: RF /Pb free device	<b>Product code</b> BLN : BALUN	<b>Dimension code</b> Per 2 digits of Length, Width, Thickness : e.g. : 160807 = Length16, Width 08, Thickness 07	<b>Unit of dimension</b> 0: 0.1 mm 1: 1.0 mm	<b>Application</b> A: 2.4GHz ISM Band	<b>Specification</b> Design Code	<b>Packing</b> T=7" Reeled G=13" Reeled B=Bulk X: SFC product

### Dimensions

Symbol	Dimension
L	1.60 ± 0.10 mm
W	0.85 ± 0.10 mm
T	0.7 ± 0.10 mm
E	0.15 ± 0.10 mm
A	0.20 ± 0.10 mm
B	0.20 ± 0.10 mm
C	0.30 ± 0.10 mm
D	0.50 ± 0.05 mm

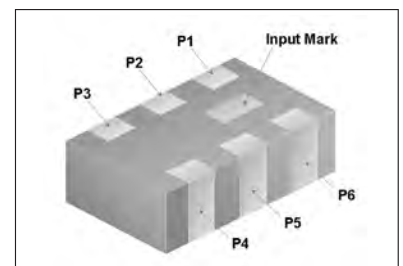
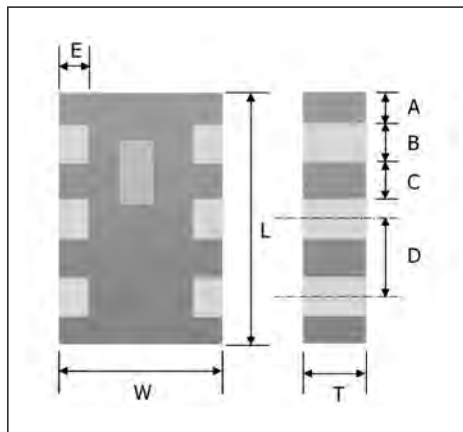

PIN	Connection
P1	Unbalanced Port
P2	Non Connection
P3	Ground
P4	Balanced port
P5	Non Connection
P6	Balanced port

### RGBLN1608070A1T Series

Part Nr.	Frequency(MHz)	Impedance (Ω)		Return Loss (dB) Min.	Inband Amplitude imbalance (dB) Max.	Inband Phase imbalance (degree)	Insertion Loss (dB)
		Unbalanced	Balanced				
RGBLN1608070A1T	2450 ± 50	50	100	10	2.0	180 ± 15	1.5

### Typical Electrical Characteristics:

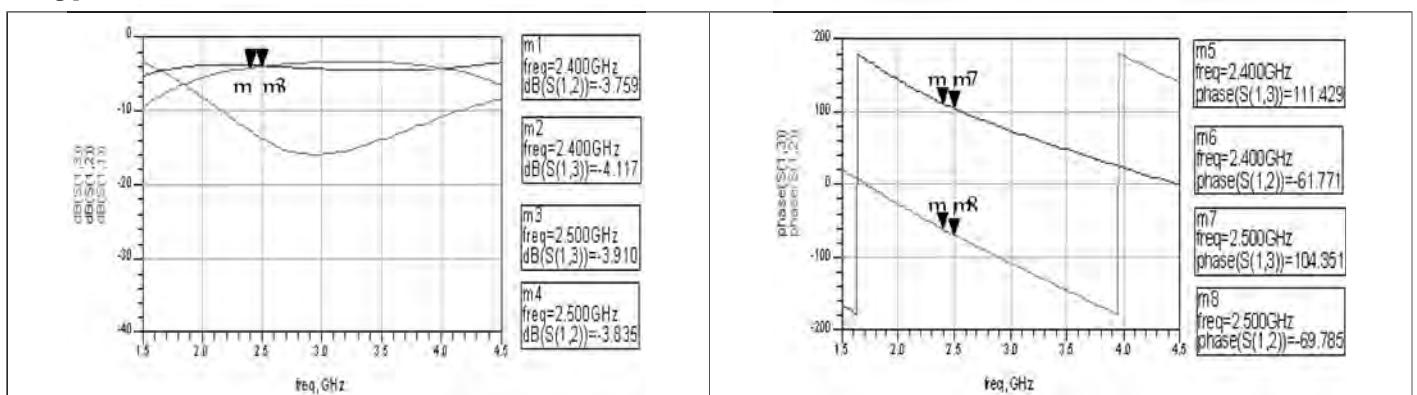



## 2.4 GHz High Frequency Devices-Balun-RGBLN1608070A5T

### How to Order

RG	BLN	160807	0	A	5	T
<b>Walsin</b> RG: RF /Pb free device	<b>Product code</b> BLN : BALUN	<b>Dimension code</b> Per 2 digits of Length, Width, Thickness : e.g. : 160807 = Length16, Width 08, Thickness 07	<b>Unit of dimension</b> 0: 0.1 mm 1: 1.0 mm	<b>Application</b> A: 2.4GHz ISM Band	<b>Specification</b> Design Code	<b>Packing</b> T=7" Reeled G=13" Reeled B=Bulk X: SFC product

### Dimensions

Symbol	Dimension
L	1.60 ± 0.10 mm
W	0.85 ± 0.10 mm
T	0.70 ± 0.10 mm
E	0.15 ± 0.10 mm
A	0.15 ± 0.10 mm
B	0.25 ± 0.10 mm
C	0.25 ± 0.10 mm
D	0.50 ± 0.05 mm

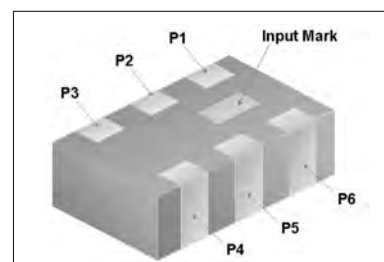
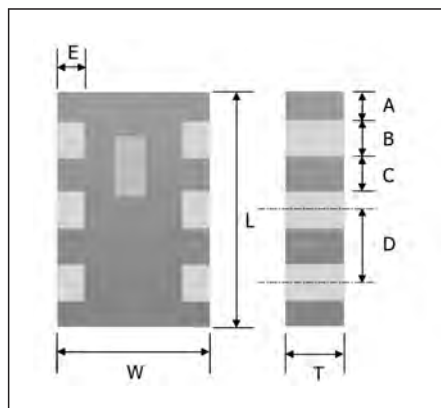

PIN	Connection
P1	Unbalanced Port
P2	DC or GND
P3	Balanced port
P4	Balanced port
P5	GND
P6	NC

### RGBLN1608070A5T Series

Part Nr.	Frequency(MHz)	Impedance (Ω)		Return Loss (dB) Min.	Inband Amplitude imbalance (dB) Max.	Inband Phase imbalance (degree)	Insertion Loss (dB)
		Unbalanced	Balanced				
RGBLN1608070A5T	2450 ± 50	50	100	10	2.0	180 ± 10	1.2

### Typical Electrical Characteristics:

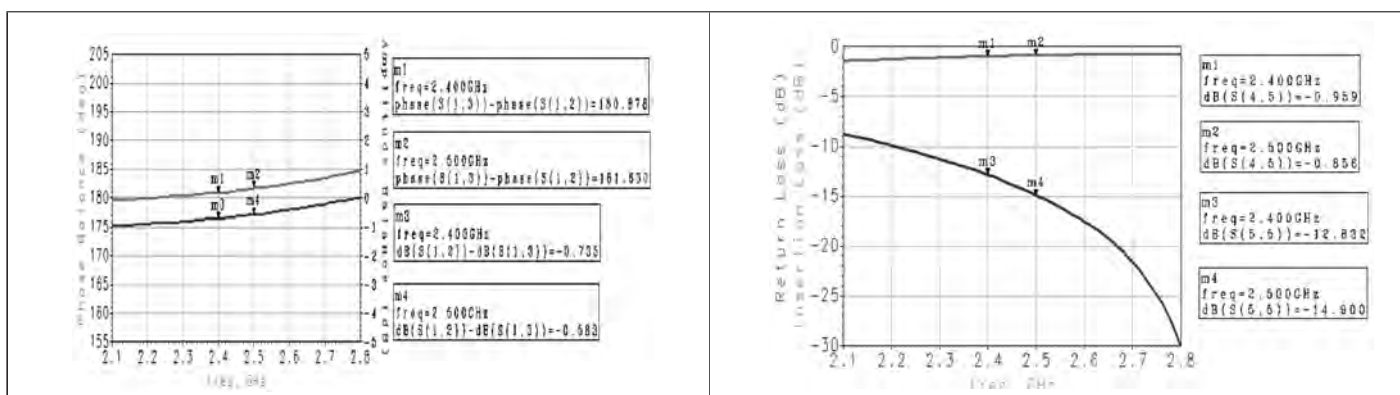

## ■ 2.4/4.9/5.2/5.8 GHz WLAN IEEE802.11 a/b/g Combo-Chip Antenna-RFANT6050110L□T

### ■ How to Order

RF	ANT	605011	0	L	□	T
<b>Walsin</b> RF device	<b>Product code</b> ANT: Antenna	<b>Dimension code</b> Per 2 digits of Length, Width, Thickness : e.g. : 605011 = Length60, Width 50, Thickness 11	<b>Unit of dimension</b> 0: 0.1 mm 1: 1.0 mm	<b>Application</b> L: 2.4/4.9/5.8 GHz Multiband Application	<b>Specification</b> Design Code	<b>Packing</b> T=7" Reeled G=13" Reeled B=Bulk X: SFC product

### ■ Dimensions

RFANT6050110L0T			RFANT6050110L1T		
Symbol	Dimension	Port Definition	Symbol	Dimension	Port Definition
L	5.9 ± 0.3 mm	---	c	1.0 ± 0.2 mm	---
W	5.1 ± 0.3 mm	---	d	2.0 ± 0.2 mm	---
T	1.1 ± 0.1 mm	---	1	1.0 ± 0.2 mm	50 Ω RF Feeding
a	0.45 ± 0.2 mm	---	2	1.0 ± 0.2 mm	Ground Termination
b	1.0 ± 0.2 mm	---	3	1.0 ± 0.2 mm	Solder Termination

### ■ RFANT6050110L□T Series

Item	Specification		
Central Frequency	2.45 GHz	5.25 GHz	5.85 GHz
Gain (Typical)	1.5 dBi	4 dBi	4 dBi
Bandwidth (Typical)	100 MHz	200 MHz	100 MHz
VSWR	2 Max.		
Polarization	Linear		
Azimuth Bandwidth	Omni-directional		
Impedance	50 Ω		

## ■ Typical Electrical Characteristics:

RFANT6050110L0T (Right side)		2.45GHz	5.80GHz
	E-Plane	<p>Peak Gain = +4.74 dBi Average Gain = -1.46 dBi</p>	<p>Peak Gain = +4.99 dBi Average Gain = -1.31 dBi</p>
	Return Loss (S11)	<p>Peak Gain = +0.48 dBi Average Gain = -4.59 dBi</p>	<p>Peak Gain = +3.02 dBi Average Gain = -0.85 dBi</p>
RFANT6050110L1T (Left side)		2.45GHz	5.80GHz
	E-Plane	<p>Peak Gain = +3.82 dBi Average Gain = -1.19 dBi</p>	<p>Peak Gain = +4.81 dBi Average Gain = -1.42 dBi</p>
	Return Loss (S11)	<p>Peak Gain = +0.16 dBi Average Gain = -4.33 dBi</p>	<p>Peak Gain = +3.13 dBi Average Gain = -0.85 dBi</p>

## 2.4/4.9/5.2/5.8 GHz High Frequency Devices-Diplexer-RFDIP2012100L□T

### How to Order

RF	DIP	201210	0	L	□	T
<b>Walsin</b> RF Device	<b>Product code</b> DIP : Diplexer	<b>Dimension code</b> 201210 = Length = 20 Width = 12 Thickness = 10	<b>Unit of dimension</b> 0: 0.1 mm 1: 1.0 mm	<b>Application</b> L: 2.4/ 4.9/ 5.2/ 5.8GHz Multiband Application	<b>Specification</b> Design Code	<b>Packing</b> T=7" Reeled G=10" Reeled B=Bulk X: SFC product

### Dimensions

Symbol	Dimension
L	2.00 ± 0.15 mm
W	1.25 ± 0.15 mm
T	0.95 ± 0.10 mm
a	0.20 ± 0.20 mm
b	0.30 ± 0.20 mm
c	0.35 ± 0.20 mm
d	0.65 ± 0.20 mm
e	0.30 ± 0.20 mm
f	0.25 ± 0.20 mm

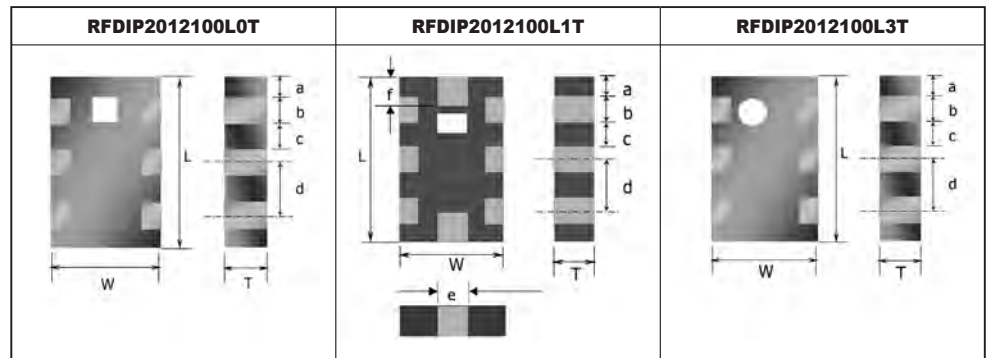

### RFDIP2012100L□T Series

Item	RFDIP2012100L0T		RFDIP2012100L1T		RFDIP2012100L3T	
	Band 1	Band 2	Band 1	Band 2	Band 1	Band 2
Central Frequency	2450 ± 50 MHz	5400 ± 500 MHz	2450 ± 50 MHz	5400 ± 500 MHz	2450 ± 50 MHz	5400 ± 500 MHz
Impedance	50 Ω	50 Ω	50 Ω	50 Ω	50 Ω	50 Ω
insertion Loss	0.7 dB	0.9 dB	0.7 dB	0.9 dB	0.7 dB	0.9 dB
Return Loss	Min.10 dB		Min.10 dB		Min.10 dB	
Attenuation	-20 dB @ 4.9 GHz -25 dB @ 5.2 GHz -25 dB @ 5.8 GHz	-25 dB @ 2.45 GHz	-20 dB @ 4.9 GHz -20 dB @ 5.2 GHz -20 dB @ 5.8 GHz	-20 dB @ 2.45 GHz	-20 dB @ 4.9 GHz -25 dB @ 5.2 GHz -25 dB @ 5.8 GHz	-25 dB @ 2.45 GHz
Ripple	0.5 dB		0.5 dB		0.5 dB	

### Typical Electrical Characteristics:

RFDIP2012100L0T	RFDIP2012100L1T	RFDIP2012100L3T
<b>Frequency Characteristics</b> 	<b>Frequency Characteristics</b> 	<b>Frequency Characteristics</b> 

## 4.9/ 5.2/ 5.8 GHz High Frequency Devices-Balun-RFBLN2012090K□T

### How to Order

RF	BLN	201209	0	K	□	T
<b>Walsin</b> RF Device	<b>Product code</b> BLN : BALUN	<b>Dimension code</b> 201209 = Length = 20 Width = 12 Thickness = 09	<b>Unit of dimension</b> 0: 0.1 mm 1: 1.0 mm	<b>Application</b> K: ISM 5.2/5.8 GHz Dualband Application	<b>Specification</b> Design Code	<b>Packing</b> T=7" Reeled G=13" Reeled B=Bulk X: SFC product

### Dimensions

Symbol	Dimension	Terminals	Connection
L	2.00 ± 0.15 mm	1	Unbalanced port
W	1.25 ± 0.15 mm	2	Ground or DC feed
t	0.95 ± 0.10 mm	3	Balanced port
a	0.20 ± 0.20 mm	4	Balanced port
b	0.30 ± 0.20 mm	5	Ground
c	0.35 ± 0.20 mm	6	Non Connection
d	0.65 ± 0.20 mm		
f	0.30 ± 0.20 mm		

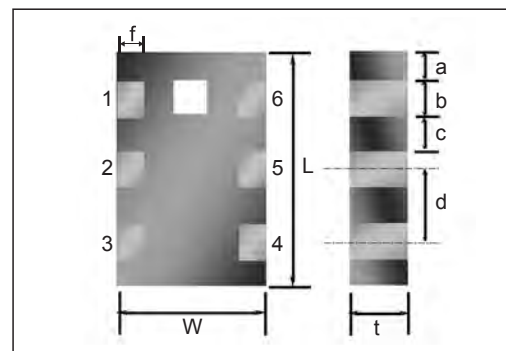

### RFBLN2012090K□T Series

Part Number.	Frequency(MHz)	Impedance (Ω)		Return Loss (dB) Min.	Inband Amplitude imbalance (dB) Max.	Inband Phase imbalance (degree)	Insertion Loss (dB)
		Unbalanced	Balanced				
RFBLN2012090K0T	5400 ± 500	50	50	-10	2.0	180° ± 10°	-1.1
RFBLN2012090K1T	5400 ± 500	50	100	-10	2.0	180° ± 10°	-1.2

### Typical Electrical Characteristics (RFBLN2012090K1T):

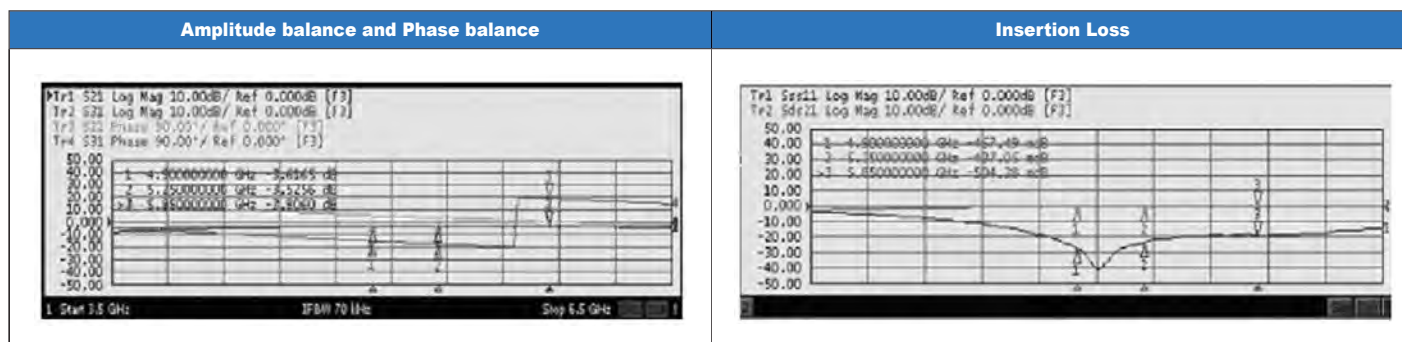



## ■ 4.9/ 5.2/ 5.8 GHz High Frequency Devices-Band Pass Filter-RFBPF2012100K0T

### ■ How to Order

RF	BPF	201210	0	K	0	T
<b>Walsin</b>	<b>Product code</b>	<b>Dimension code</b>	<b>Unit of dimension</b>	<b>Application</b>	<b>Specification</b>	<b>Packing</b>
RF Device	BPF : Band Pass Filter	201210 = Length = 20 Width = 12 Thickness = 10	0: 0.1 mm 1: 1.0 mm	K: ISM 5.2/5.8 GHz Dualband Application	Design Code	T=7" Reeled G=10" Reeled B=Bulk X: SFC product

### ■ Dimensions

Symbol	Dimension
L	2.00 ± 0.15 mm
W	1.25 ± 0.15 mm
T	0.95 ± 0.10 mm
A	0.25 ± 0.15 mm
B	0.25 ± 0.10 mm
C	0.25 ± 0.10 mm
D	0.25 ± 0.15 mm
E	1.00 ± 0.15 mm

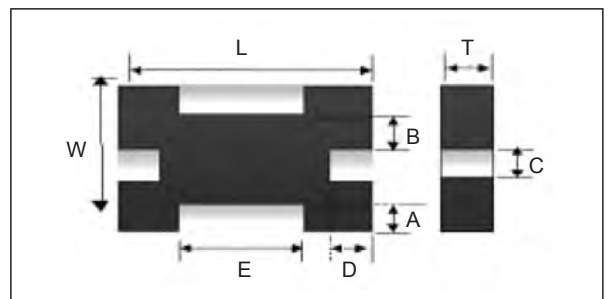

### ■ RFBPF2012100K0T Series

Item	Specification
Central Frequency	5400 ± 500 MHz
Insertion Loss (dB)	-1.7 dBi @ 4.90 GHz -1.5 dBi @ 5.25 GHz -1.5 dBi @ 5.85 GHz
VSWR	2.0 Max.
Ripple	0.6 dB
Attenuation (Min.)	-30 dBi @ 3450 MHz -20 dBi @ 11000 MHz

### ■ Typical Electrical Characteristics:

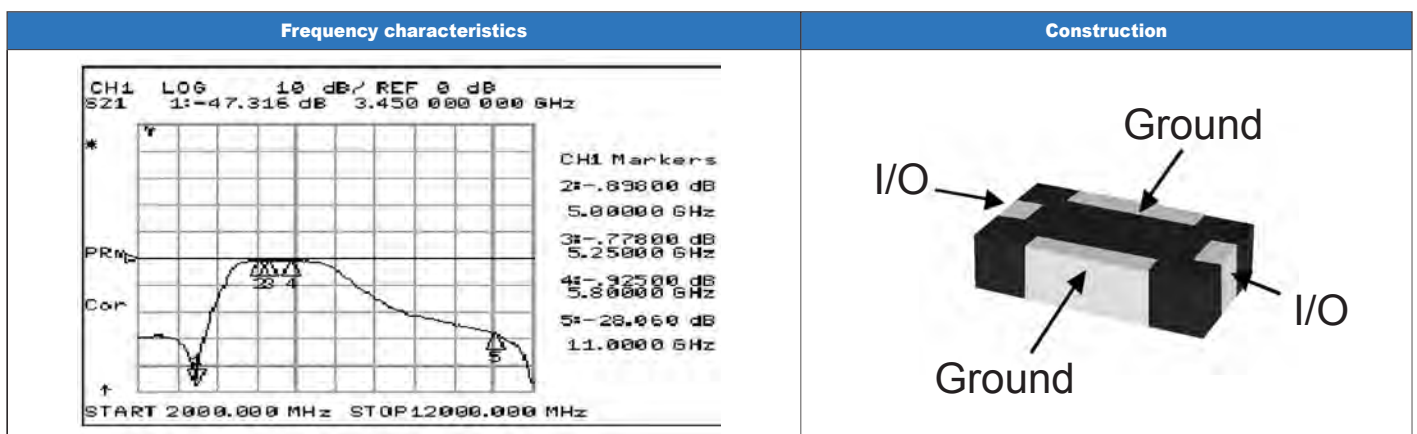



## ■ LTCC EMI Filter Array (4 Channel EMI Filter Array) - RGEMA2012080B□T

### ■ How to Order

RG	EMA	201208	0	B	□	T
<b>Walsin</b> RG: RF/Pb free device	<b>Product code</b> EMI filter array	<b>Dimension code</b> Per 2 digits of Length, Width, Thickness : e.g. : 201208 = Length20, Width 12, Thickness 8	<b>Unit of dimension</b> 0: 0.1 mm 1: 1.0 mm	<b>Application</b> B: GSM Band	<b>Specification</b> Design Code	<b>Packing</b> T=7" Reeled G=10" Reeled B=Bulk X: SFC product

### ■ Dimensions

Symbol	Dimension (mm)
L	2.00 ± 0.10
W	1.20 ± 0.05
T	0.80 ± 0.10
a	0.25 ± 0.05
b	0.40 ± 0.05
c	0.10 ± 0.05
d	0.25 ± 0.05
e	0.20 ± 0.05

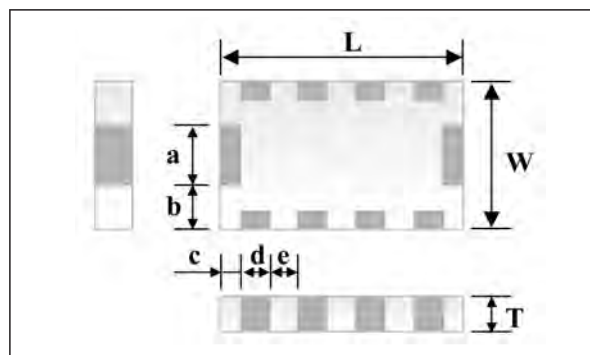

### ■ RGEMA2012080B□T Series

Item	RGEMA2012080B4T	RGEMA2012080B5T	RGEMA2012080B6T
Attenuation (min)	20dB @ 800~2500 MHz	20dB @ 800~2500 MHz	20dB @ 800~2500 MHz
-3dB Cut-Off Frequency	400MHz +/-15%	500MHz +/-15%	600MHz +/-15%
Rated Current	100 mA	100 mA	100 mA
Isolation	20dB	20dB	20dB
Capacitance @ 1MHz(Reference)	25 pF +/-20%	25 pF +/-20%	22 pF +/-20%
ESD surge capability (KV)	>15	>15	>15

### ■ Typical Electrical Characteristics:

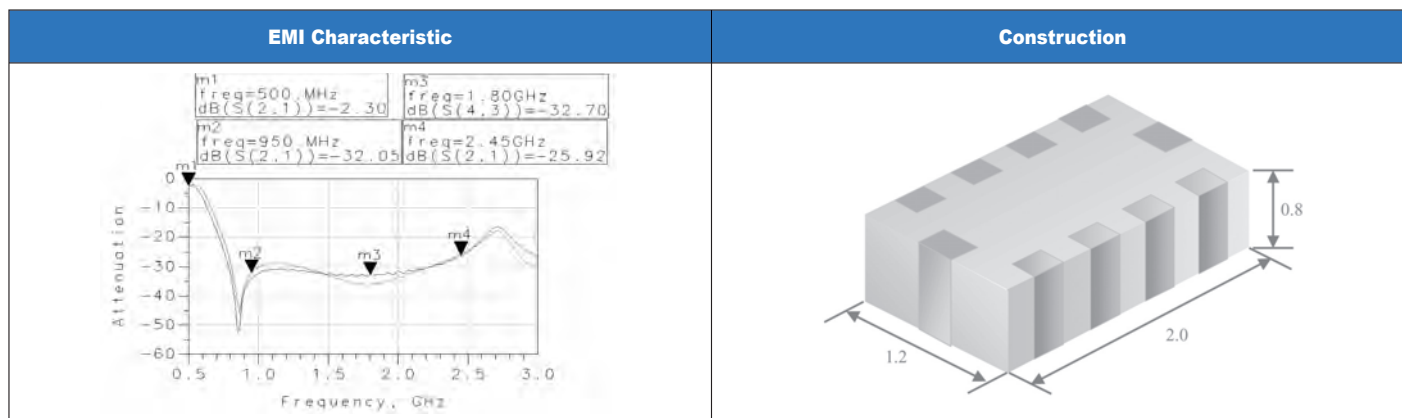

## ■ LTCC EMI Filter Array (4 Channel EMI Filter Array) - RFLVA2012080B□T

### ■ How to Order

RG	LVA	201208	0	B	□	T
<b>Walsin</b>	<b>Product code</b>	<b>Dimension code</b>	<b>Unit of dimension</b>	<b>Application</b>	<b>Specification</b>	<b>Packing</b>
RF Device	EMI filter array	Per 2 digits of Length, Width, Thickness : e.g. : 201208 = Length20, Width 12, Thickness 8	0: 0.1 mm 1: 1.0 mm	B: GSM Band	Design Code	T=7" Reeled G=10" Reeled B=Bulk X: SFC product

### ■ Dimensions

Symbol	Dimension (mm)
L	2.00 ± 0.10
W	1.20 ± 0.10
T	0.80 ± 0.10
a	0.13 ± 0.10
b	0.24 ± 0.12
c	0.26 ± 0.12
d	0.50 ± 0.12
e	0.27 ± 0.10
f	0.20 ± 0.15
g	0.20 ± 0.15

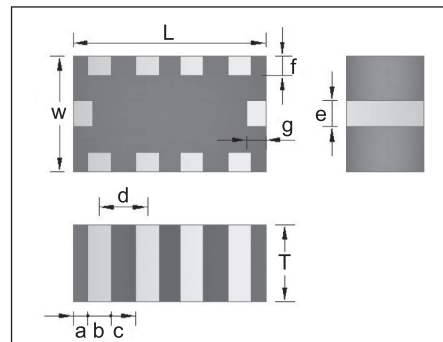

### ■ EMI Specification

Item	Specification
Attenuation (min)	20dB @900 MHz 20dB @2000 MHz
Cut-Off Frequency (Typical)	120/ 220MHz ± 30%
Rated Current	100 mA
Operating Temperature	-40 ~ +85 deg. c
Capacitance @1MHz (Reference)	40/ 30 pF ± 20%
DC Resistance (Reference)	5.0 ohm ± 20%

### ■ ESD Specification

Max. Continuous Working Voltage	Max. Clamping Voltage at Specified Current (8/20 us)	Varistor Voltage At 1mA (DC) current	
V <sub>M(DC)</sub>	V <sub>c</sub> at 1A	Min.	Max.
5V	85V	30V	55V

### ■ Typical Electrical Characteristics:

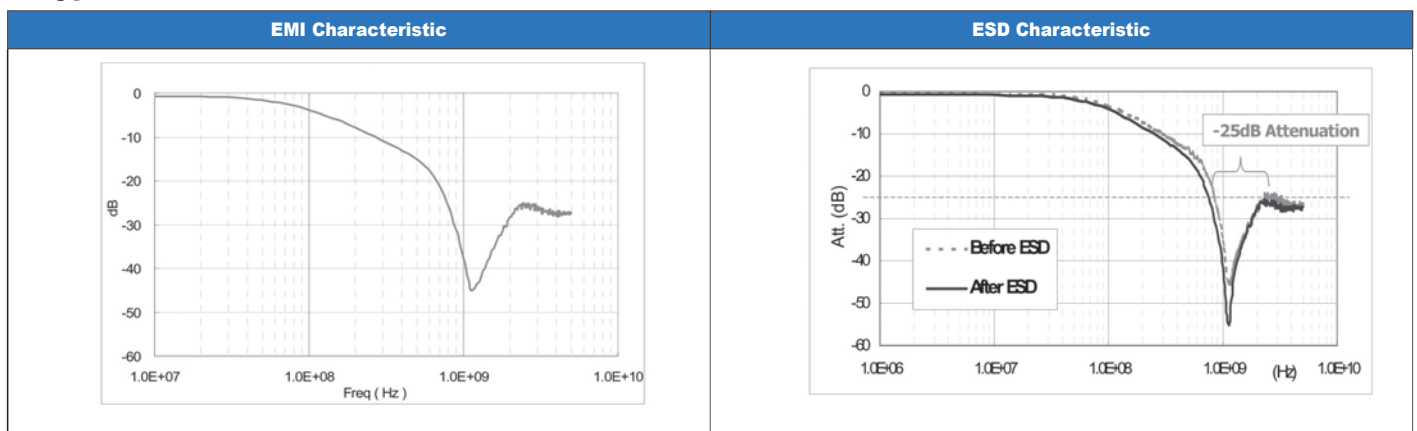

## High Frequency Inductors

### How to Order

WL	160808	G	4N7	S	G	T	03
<b>Product code</b>	<b>Dimension code</b>	<b>Material</b>	<b>Inductance</b>	<b>Tolerance</b>	<b>Specification</b>	<b>Packing</b>	<b>Rated Current</b>
WL: HF Inductor	160808 = L: 1.6mm W: 0.8mm T: 0.8mm 100505 = L: 1.0mm W: 0.5mm T: 0.5mm	A B C D E F G	For Ls<10nH 1N0=1.0nH 4N7=4.7nH 10N=10nH	S: ±0.3nH J: ±5% K: ±10% C: Customized	N=Normal A=±0.2nH G=Green	T=Reeled B=Bulk	03=250mA or 300mA 02=150mA or 200mA

### Dimensions

Symbol	WL1608 Series	WL1005 Seeries	WL0603 Seeries
L	1.60 ± 0.15 mm	1.00 ± 0.10	0.60 ± 0.03
W	0.80 ± 0.15 mm	0.50 ± 0.10	0.30 ± 0.03
T	0.80 ± 0.15 mm	0.50 ± 0.10	0.30 ± 0.03
Ts	0.30 ± 0.20 mm	0.25 ± 0.10	0.15 ± 0.05

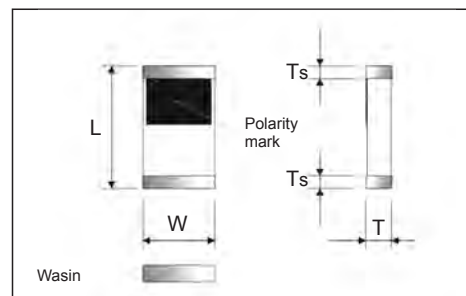

### High Frequency Inductors 1608 (0603)

Part Number.	L(nH)	Tolerance	Q Min (100 MHz)	Typical Q @ Frequency (MHz)			SRF Typical (MHz)	DC Resistance Max. (Ω)	IDC (mA)
				100	800	1800			
WL160808G1N0SGT03	1.0	±0.3nH	8	13	44	60	8100	0.10	300
WL160808G1N2SGT03	1.2	±0.3nH	8	13	44	60	8100	0.10	300
WL160808G1N5SGT03	1.5	±0.3nH	8	14	37	56	8100	0.10	300
WL160808G1N8SGT03	1.8	±0.3nH	8	12	37	55	8300	0.10	300
WL160808G2N2SGT03	2.2	±0.3nH	8	12	38	54	8000	0.10	300
WL160808G2N7SGT03	2.7	±0.3nH	8	13	38	53	7600	0.10	300
WL160808G3N3SGT03	3.3	±0.3nH	8	12	37	49	5800	0.12	300
WL160808G3N9SGT03	3.9	±0.3nH	8	14	44	62	5100	0.14	300
WL160808G4N7SGT03	4.7	±0.3nH	8	15	43	63	4600	0.16	300
WL160808G5N6SGT03	5.6	±0.3nH	8	15	45	59	4200	0.18	300
WL160808G6N8JGT03	6.8	±5%	8	15	43	58	3700	0.22	300
WL160808G8N2JGT03	8.2	±5%	8	15	44	52	3600	0.24	300
WL160808G10NJGT03	10	±5%	12	17	49	50	3500	0.26	300
WL160808G12NJGT03	12	±5%	12	15	41	37	2500	0.28	300
WL160808G15NJGT03	15	±5%	12	17	45	35	2600	0.32	300
WL160808G18NJGT03	18	±5%	12	16	45	39	2000	0.35	300
WL160808G22NJGT03	22	±5%	12	16	43	21	1800	0.40	300
WL160808G27NJGT03	27	±5%	12	16	41	11	1600	0.45	300
WL160808G33NJGT03	33	±5%	12	19	41	11	1500	0.55	300
WL160808G39NJGT03	39	±5%	12	19	42	17	1400	0.60	300
WL160808G47NJGT03	47	±5%	12	17	35	-	1300	0.70	300
WL160808G56NJGT03	56	±5%	12	19	31	-	1300	0.75	300
WL160808G68NJGT03	68	±5%	12	19	26	-	1150	0.85	300
WL160808G82NJGT03	82	±5%	12	19	21	-	1000	0.95	300
WL160808GR10JGT03	100	±5%	12	19	20	-	1000	1.00	300
WL160808GR12JGT03	120	±5%	12	19	16	-	950	1.20	300
WL160808GR15JGT03	150	±5%	12	19	-	-	800	1.50	300
WL160808GR18JGT03	180	±5%	12	19	-	-	750	1.90	300
WL160808GR22JGT03	220	±5%	12	18	-	-	680	2.20	300
WL160808GR27JGT03	270	±5%	12	20	-	-	600	2.50	300

## High Frequency Inductors

### High Frequency Inductors 1005 (0402)

Part Number.	L(nH)	Tolerance	Q Min (100 MHz)	Typical Q @ Frequency (MHz)			SRF Typical (MHz)	DC Resistance Max. (Ω)	IDC (mA)
				100	800	1800			
WL100505G1N0SGT03	1.0	±0.3nH	8	9	27	44	13000	0.12	300
WL100505G1N2SGT03	1.2	±0.3nH	8	9	25	45	12000	0.12	300
WL100505G1N5SGT03	1.5	±0.3nH	8	9	23	43	10000	0.13	300
WL100505G1N8SGT03	1.8	±0.3nH	8	9	24	43	9000	0.14	300
WL100505G2N2SGT03	2.2	±0.3nH	8	9	26	45	9000	0.16	300
WL100505G2N7SGT03	2.7	±0.3nH	8	9	26	42	8000	0.17	300
WL100505G3N3SGT03	3.3	±0.3nH	8	9	26	42	6500	0.19	300
WL100505G3N9□GT03	3.9	±0.3nH ±10%	8	9	26	40	6000	0.22	300
WL100505G4N7□GT03	4.7	±0.3nH ±10%	8	9	27	46	5000	0.23	300
WL100505G5N6□GT03	5.6	±0.3nH ±10%	8	10	28	40	4700	0.27	300
WL100505G6N8□GT03	6.8	±5% ±10%	8	10	28	36	4500	0.32	250
WL100505G8N2□GT03	8.2	±5% ±10%	8	10	28	36	4000	0.37	250
WL100505G10N□GT03	10	±5% ±10%	8	10	27	33	3500	0.42	250
WL100505G12N□GT03	12	±5% ±10%	8	11	31	41	3000	0.48	250
WL100505G15N□GT03	15	±5% ±10%	8	10	27	33	2900	0.53	250
WL100505G18N□GT02	18	±5% ±10%	8	11	29	31	2200	0.65	200
WL100505G22N□GT02	22	±5% ±10%	8	10	26	15	2100	0.80	200
WL100505G27N□GT02	27	±5% ±10%	8	10	23	15	2000	0.90	200
WL100505G33N□GT02	33	±5% ±10%	8	10	22 note 1	24 note 2	1900	1.00	200
WL100505G39N□GT02	39	±5% ±10%	8	10	19 note 1	20 note 2	1800	1.20	200
WL100505G47N□GT02	47	±5% ±10%	8	12	22 note 1	20 note 2	1500	1.30	200
WL100505G56N□GT02	56	±5% ±10%	8	12	22 note 1	18 note 2	1400	1.60	200
WL100505G68N□GT02	68	±5% ±10%	8	11	18 note 1	10 note 2	1200	1.90	180
WL100505G82N□GT02	82	±5% ±10%	8	12	20 note 1	7 note 2	1100	2.10	150
WL100505GR10□GT01	100	±5% ±10%	8	11	18 note 1	-	930	2.30	100

Note 1: at 500MHz

Note 2: at 1000MHz

For special inductance values, please contact with sales representatives of the HF Business Division.

## High Frequency Inductors

### High Frequency Inductors 0603 (0201)

Walsiv Part Number.	L(nH)	Tolerance	Q Min (100 MHz)	Typical Q @ Frequency (MHz)			SRF Typical (MHz)	DC Resistance Max. ( $\Omega$ )	IDC (mA)
				100	800	1800			
WL060303G1N0SGT03	1.0	$\pm 0.3nH$	4	13	17	26	13000	0.12	300
WL060303G1N2SGT03	1.2	$\pm 0.3nH$	4	14	17	26	13000	0.15	300
WL060303G1N5SGT03	1.5	$\pm 0.3nH$	4	14	17	26	13000	0.18	300
WL060303G1N8SGT03	1.8	$\pm 0.3nH$	4	15	17	28	10500	0.22	300
WL060303G2N2SGT03	2.2	$\pm 0.3nH$	4	15	18	28	9500	0.26	300
WL060303G2N7SGT03	2.7	$\pm 0.3nH$	4	16	18	18	8500	0.32	300
WL060303G3N3SGT03	3.3	$\pm 0.3nH$	4	16	19	28	7500	0.38	300
WL060303G3N9SGT03	3.9	$\pm 0.3nH$	4	16	20	26	6800	0.45	300
WL060303G4N7SGT03	4.7	$\pm 0.3nH$	4	16	20	26	6000	0.50	300
WL060303G5N6SGT03	5.6	$\pm 0.3nH$	5	16	20	25	5500	0.60	300
WL060303G6N8JGT03	6.8	$\pm 5\%$	5	16	20	25	4800	0.70	250
WL060303G8N2JGT03	8.2	$\pm 5\%$	5	16	20	23	4600	0.90	250
WL060303G10NJGT03	10	$\pm 5\%$	5	16	20	23	4000	1.20	250
WL060303G12NJGT03	12	$\pm 5\%$	5	16	19	22	3500	1.30	250
WL060303G15NJGT03	15	$\pm 5\%$	5	15	19	18	3000	1.40	250
WL060303G18NJGT02	18	$\pm 5\%$	5	15	19	16	2500	1.50	200
WL060303G22NJGT02	22	$\pm 5\%$	5	14	18	15	2200	1.80	200
WL060303G27NJGT03	27	$\pm 5\%$	5	13	18	9	1800	2.00	200
WL060303G33NJGT03	33	$\pm 5\%$	5	13	17	7	1500	2.30	200

### Package

1. Reel material; Polystyrene
2. Ordering code No., Quantity, Batch No. and Walsin
3. Parts per reel:

Size	Quantity / reel
WL 1608 Series	4K pcs
WL 1005 Series	10K pcs
WL 0603 Series	10K pcs

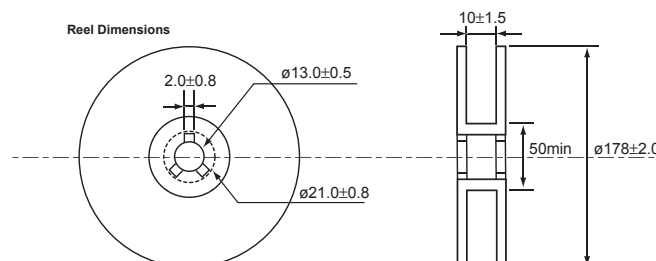

## High Frequency Devices - Common Mode Filter - RFCMF1632140M2T / RFCMF1632100M3T

### How to Order

RF	CMF	163214	0	M	2	T
<b>Walsin</b>	<b>Product code</b>	<b>Dimension code</b>	<b>Unit of dimension</b>	<b>Application</b>	<b>Specification</b>	<b>Packing</b>
RF Device	CMF: Common Mode Filter	163214 = Length = 16 Width = 32 Thickness = 14 163210 = Length = 16 Width = 32 Thickness = 10	0: 0.1 mm 1: 1.0 mm	M: USB 2.0 / IEEE1394	Design Code	T=7" Reeled G=10" Reeled B=Bulk X: SFC product

### Dimensions

Symbol	RFCMF1632140M2T	RFCMF1632100M3T
L	1.60 ± 0.20 mm	1.60 ± 0.20 mm
W	3.20 ± 0.20 mm	3.20 ± 0.20 mm
T	1.40 ± 0.20 mm	1.00 ± 0.20 mm
P	1.10 ± 0.20 mm	1.10 ± 0.20 mm
a	0.60 ± 0.20 mm	0.60 ± 0.20 mm
b	0.50 ± 0.20 mm	0.50 ± 0.20 mm

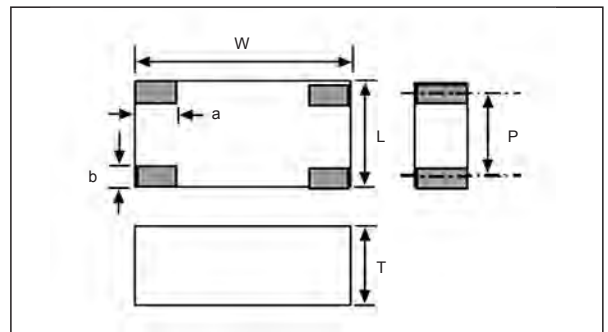

### RFCMF1632140M2T Series

Item	Specification
Common Mode Attenuation	Min. 9 dB @ 140MHz ~ 1GHz
Differential Mode Insertion Loss	Max. 0.8 dB @ 240MHz
DC Resistance	Max. 2.5Ω
Rated Current	300 mA
Characteristic Impedance	(Differential) 90Ω

### RFCMF1632100M3T Series

Item	Specification
Common Mode Attenuation	Min. 9 dB @ 240MHz ~ 1GHz
Differential Mode Insertion Loss	Max. 0.6 dB @ 240MHz
DC Resistance	Max. 1.5Ω
Rated Current	300 mA
Characteristic Impedance	(Differential) 90Ω

### Typical Electrical Characteristics:

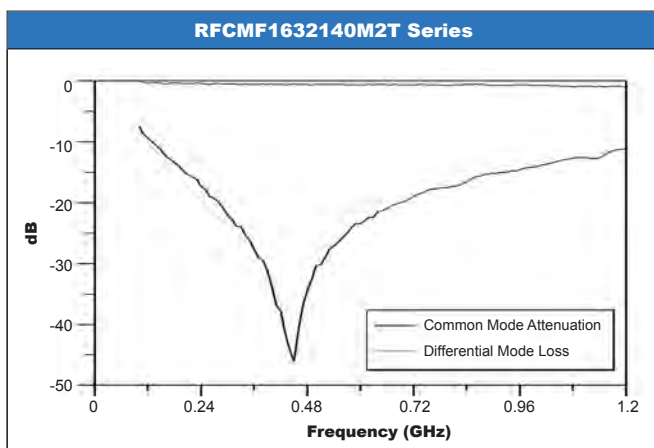

### Typical Electrical Characteristics:

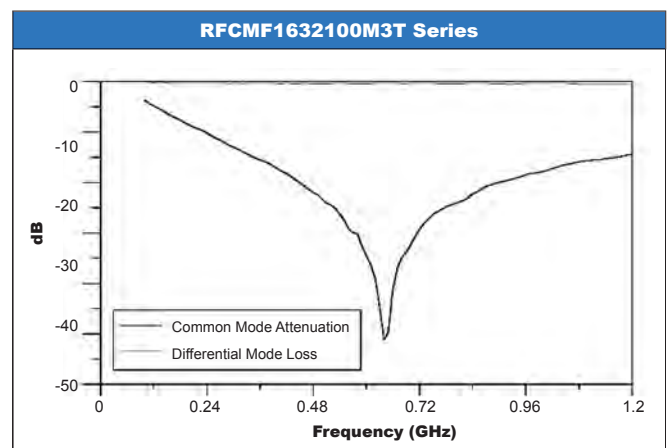



## High Frequency Devices - Common Mode Filter - RFCMF1220100M□T

### How to Order

RF	CMF	122010	0	M	□	T
<b>Walsin</b> RF Device	<b>Product code</b> CMF: Common Mode Filter	<b>Dimension code</b> 122010 = Length = 12 Width = 20 Thickness = 10	<b>Unit of dimension</b> 0: 0.1 mm 1: 1.0 mm	<b>Application</b> M: USB 2.0 / IEEE1394	<b>Specification</b> Design Code	<b>Packing</b> T=7" Reeled G=10" Reeled B=Bulk X: SFC product

### Dimensions

Symbol	Dimension
L	1.20 ± 0.20 mm
W	2.00 ± 0.20 mm
T	1.00 ± 0.20 mm
P	0.80 ± 0.10 mm
a	0.45 ± 0.20 mm
b	0.40 ± 0.20 mm

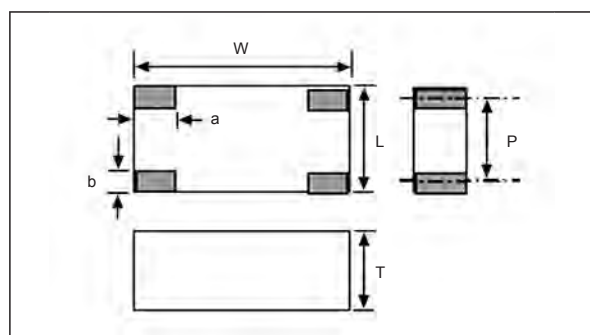

### RFCMF1220100M3T Series

Item	Specification
Common Mode Attenuation	Min. 9 dB @ 240MHz ~ 1GHz
Differential Mode Insertion Loss	Max. 0.6 dB @ 240MHz
DC Resistance	Max. 1.5Ω
Rated Current	300 mA
Characteristic Impedance	(Differential) 90Ω

### RFCMF1220100M4T Series

Item	Specification
Common Mode Attenuation	Min. 9 dB @ 130MHz ~ 1GHz
Differential Mode Insertion Loss	Max. 1.0 dB @ 240MHz
DC Resistance	Max. 2.5Ω
Rated Current	200 mA
Characteristic Impedance	(Differential) 90Ω

### Typical Electrical Characteristics:

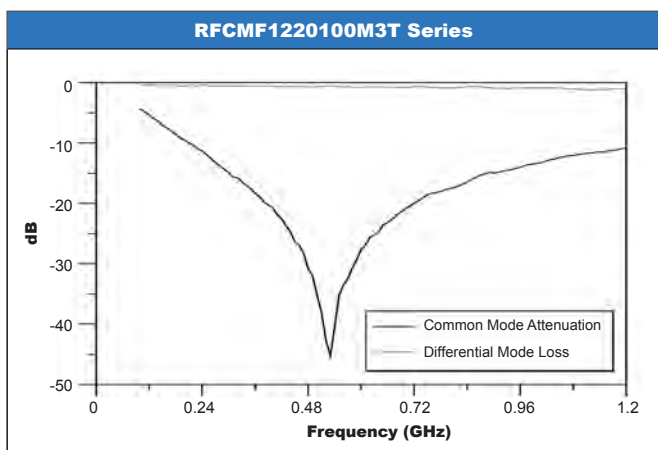

### Typical Electrical Characteristics:

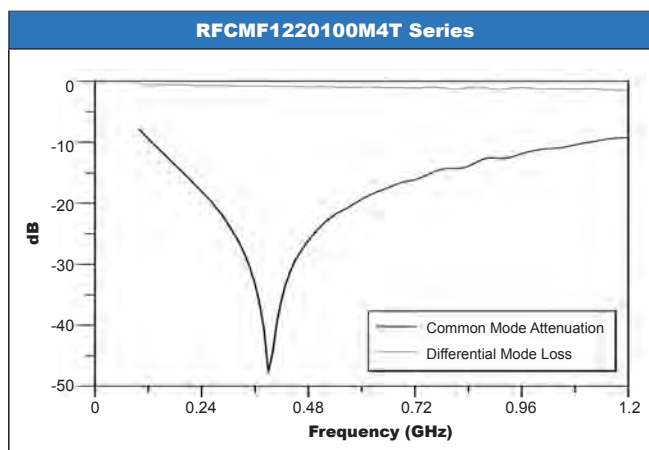

## High Frequency Devices - Common Mode Filter - RGCMF1220080M5T

### How to Order

RG	CMF	122008	0	M	5	T
<b>Walsin</b> RG: RF /Pd free device	<b>Product code</b> CMF: Common Mode Filter	<b>Dimension code</b> 122008 = Length = 12 Width = 20 Thickness = 8	<b>Unit of dimension</b> 0: 0.1 mm 1: 1.0 mm	<b>Application</b> M: USB 2.0 / IEEE1394	<b>Specification</b> Design Code	<b>Packing</b> T=7" Reeled G=10" Reeled B=Bulk X: SFC product

### Dimensions

Symbol	Dimension
L	2.00 ± 0.10 mm
W	1.25 ± 0.10 mm
T	0.80 ± 0.10 mm
A	0.35 ± 0.10 mm
B	0.55 ± 0.10 mm

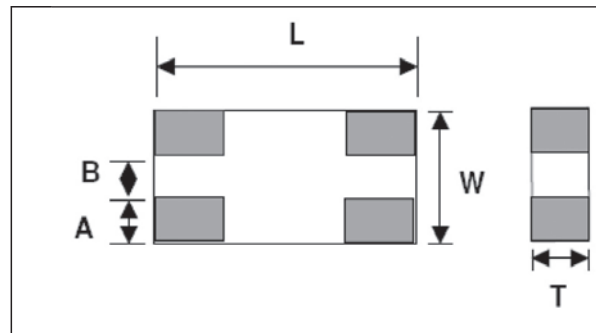

### RGCMF1220080M5T Series

Item	Specification
Common Mode Attenuation	120 ohm ±20% @ 100MHz
DC Resistance	Max. 1.5Ω
Rated Current	200 mA
Characteristic Impedance	90 Ω (Typical)
Operating Temperature	-40°C ~ 85°C

### Typical Electrical Characteristics:

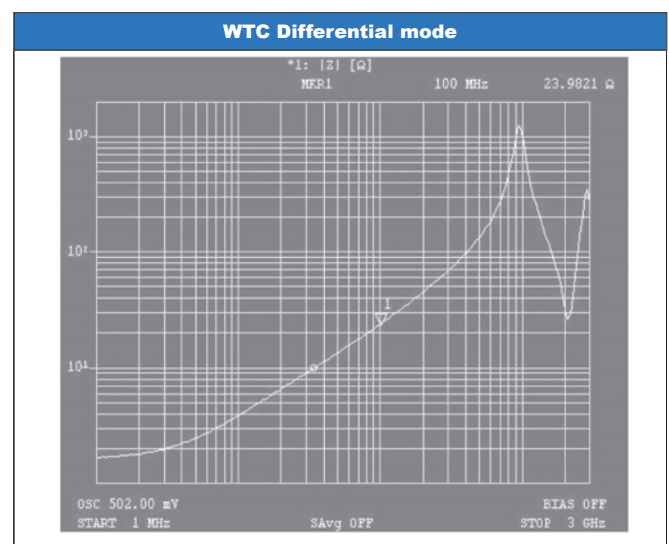
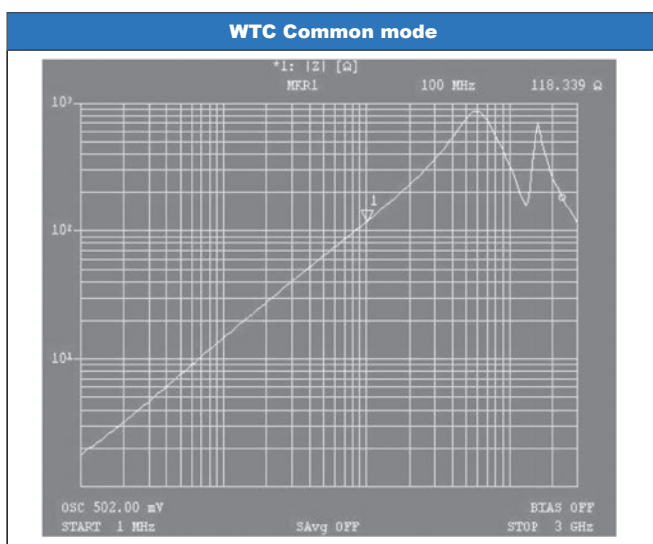

## High Frequency Devices - Common Mode Filter - RFCMF1210080M□T

### How to Order

RF	CMF	121008	0	M	□	T
<b>WalGin</b>	<b>Product code</b>	<b>Dimension code</b>	<b>Unit of dimension</b>	<b>Application</b>	<b>Specification</b>	<b>Packing</b>
RF: Device	CMF: Common Mode Filter	121008 = Length = 12 Width = 10 Thickness = 8	0: 0.1 mm 1: 1.0 mm	M: USB 2.0 / IEEE1394	Design Code	T=7" Reeled G=10" Reeled B=Bulk X: SFC product

### Dimensions

Symbol	RFCMF120080M1T	RFCMF1210080M2T
L	1.27 ± 0.1 mm	1.28 ± 0.1 mm
W	1.01 ± 0.1 mm	1.02 ± 0.1 mm
T	0.79 ± 0.1 mm	0.81 ± 0.1 mm

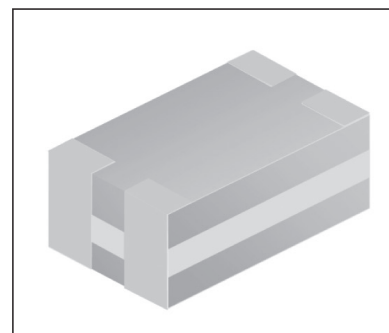
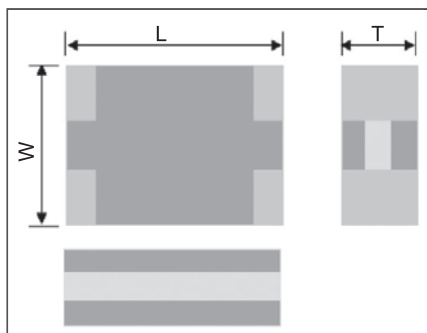

### RFCMF1210080M1T Series

Item	Specification
Characteristic Impedance	90 ohm
DC Resistance	0.85 ohm (max.)
Rated Current	100 mA
Common Mode Attenuation	70 ohm+/-20%@ 100HMZ
Operating Temperature	-40°C ~ +85°C

### RFCMF1210080M2T Series

Item	Specification
Characteristic Impedance	90 ohm
DC Resistance	1.0 ohm (max.)
Rated Current	100 mA
Common Mode Attenuation	100 ohm+/-20%@ 100HMZ
Operating Temperature	-40°C ~ +85°C

### Impedance Vs. Frequency:

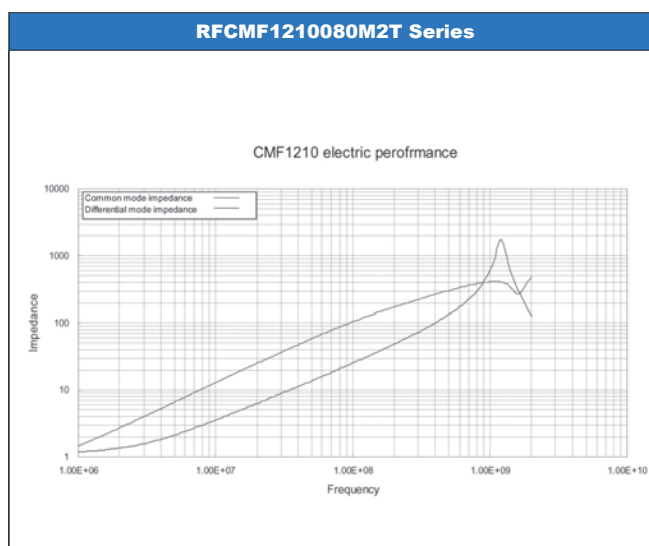
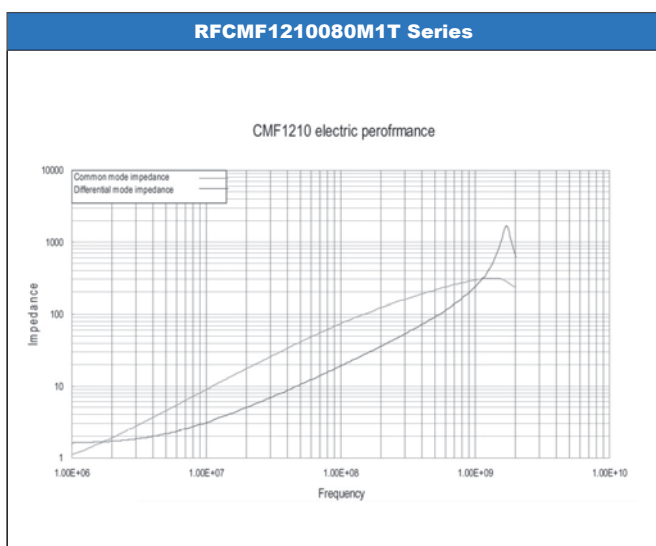

## ■ Multilayer Chip Varistor (MLV) - VZ Series & VH Series

### ■ How to Order

VH	0402	M	050	C	G	T	330	-
<b>Type code</b>	<b>Chip Size</b>	<b>Style</b>	<b>Rated Voltage</b>	<b>Cap. Tolerance</b>	<b>Termination</b>	<b>Packing</b>	<b>Cap. code (pf)</b>	<b>Special Request</b>
V: Walsin ZnO Varistor H: High Speed and RF, and Special Capacitance Concern Z: General Purpose	0402, 0603 0805, 1206 Code is L x W (in inches) 0402 = 0.4 x 0.2 0603 = 0.6 x 0.3 0805 = 0.8 x 0.5 1206 = 1.2 x 0.6	M: Multilayer A: Array*	050: 5.5Vdc 090: 9.0Vdc 120: 12.0Vdc 140: 14.0Vdc 180: 18.0Vdc 300: 30.0Vdc	A: Typ. Capacitance for Z series C: Max. capacitance for H series	G : Green Material	T=Reeled B=Bulk	This item is only for H Series. Two significant digits followed by number of Zeros 3R0=3pF when C < 10pF 330=33x10 <sup>0</sup> =33pF 101=10x10 <sup>1</sup> =100pF 102=10x10 <sup>2</sup> =1000pF	

\*Array: Please contact sales for availability

### ■ Introduction - Plated & Lead-free Termination

High Speed ESD Voltage Suppressor is an advanced series of Walsin's Multilayer Chip Varistor (MLV). Nowadays, more and more communication devices become compact and apply denser and higher frequency circuits inside. Protection against the electronic static discharge (ESD) generated from human body transient voltage surge is more important when downsize of high-speed transistor makes its vulnerability to ESD and surge. Walsin's High Speed ESD Voltage Suppressor provides protection from ESD and EFT in high-speed data line and radio frequency (RF) circuits. Also, if capacitance of MLV is a concern to circuit designers, Walsin MLV H Series would supply a solution, MLV with specified capacitance and range. It is compatible with modern reflow and wave soldering procedures. We would give you a solution to transient over voltage and ESD protection to your products.

### ■ Features

- Multilayer Fabrication Technology
- Small size (0402 & 0603)
- -55°C to 125°C Operating Temperature Range
- Operating Voltage Range  $V_M(DC)$  at 5.5V ~ 85V
- Able to withstand ESD test of IEC-61000-4-2
- Bi-directional Clamping characteristic
- Standard / Low / Customized Capacitance Types Available

### ■ Applications

- Protection of Cellular Phones, PDA, High Speed Data Line...etc.
- ESD Protection for Components Sensitive to IEC 61000-4-2, Provides Circuit Board Transient Voltage Protection for Transistors.
- Protection of Video & Audio ports.

### ■ Dimensions

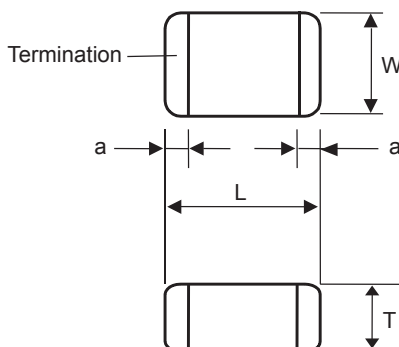

Unit: mm

Size	0402	0603	0805	1206
L	1.00 ± 0.10	1.60 ± 0.15	2.00 ± 0.20	3.20 ± 0.20
W	0.50 ± 0.10	0.80 ± 0.15	1.25 ± 0.20	1.60 ± 0.20
T	0.50 ± 0.10	0.80 ± 0.15	0.80 ± 0.20	0.80 ± 0.10* 1.10 ± 0.20**
a	0.25 ± 0.15	0.35 ± 0.15	0.50 ± 0.20	0.65 ± 0.25

Note: \*Means VZ1206 5.5Vdc~22Vdc items  
\*\*Means VZ1206 26Vdc~85Vdc items

## ■ Multilayer Chip Varistor (MLV) - VZ Series & VH Series

### ■ Quick Reference Specifications

#### VH Series

Symbol	Maximum Ratings			Specifications			
	Maximum Continuous Working Voltage	Maximum Non-Repetitive Surge Energy (10/1000µs)	Max. Clamping Voltage at Specified Current (8/20µs)	Nominal Voltage at 1mA (DC) Current		Max. Capacitance @1MHz	
				V <sub>M</sub> (DC)	V <sub>N</sub> (DC) Min.	V <sub>N</sub> (DC) Max.	C
Part Number	(V)	(J)	(V)	(V)	(V)	(pF)	%
VH0402M050CGT5R0	5	0.05	55 at 1A	20	30	5	+80/-20
VH0402M050CGT100	5	0.05	60 at 1A	24	36	10	± 30
VH0402M050CGT220	5	0.05	45 at 1A	15	25	22	± 30
VH0402M050CGT330	5	0.05	45 at 1A	15	25	33	± 30
VH0402M050CGT560	5	0.05	45 at 1A	15	25	56	± 30
VH0402M050CGT101	5	0.05	30 at 1A	11	21	100	± 30
VH0402M120CGT5R0	12	0.05	85 at 1A	33	50	5	+80/-20
VH0402M120CGT100	12	0.05	70 at 1A	27	42	10	± 30
VH0402M120CGT220	12	0.05	55 at 1A	20	30	22	± 30
VH0402M120CGT330	12	0.05	55 at 1A	20	30	33	± 30
VH0402M120CGT560	12	0.05	55 at 1A	20	30	56	± 30
VH0402M120CGT101	12	0.05	55 at 1A	20	30	100	± 30
VH0402M240CGT0R8	24	0.05	200 at 1A	100	150	0.8~1	± 30
VH0402M240CGT2R5	24	0.05	200 at 1A	100	150	2~4	± 30
VH0603M050CGT5R0	5	0.1	55 at 1A	20	30	5	+80/-20%
VH0603M050CGT100	5	0.1	60 at 1A	24	36	10	+/- 30%
VH0603M050CGT220	5	0.1	45 at 1A	15	25	22	+/- 30%
VH0603M050CGT330	5	0.1	45 at 1A	15	25	33	+/- 30%
VH0603M050CGT560	5	0.1	45 at 1A	15	25	56	+/- 30%
VH0603M050CGT101	5	0.1	30 at 1A	11	21	100	+/- 30%
VH0603M120CGT5R0	12	0.1	85 at 1A	33	50	4~9	+80/-20%
VH0603M120CGT100	12	0.1	70 at 1A	27	42	10	+/- 30%
VH0603M120CGT220	12	0.1	55 at 1A	20	30	22	+/- 30%
VH0603M120CGT330	12	0.1	55 at 1A	20	30	33	+/- 30%
VH0603M120CGT560	12	0.1	55 at 1A	20	30	56	+/- 30%
VH0603M120CGT820	12	0.1	55 at 1A	20	30	82	+/- 30%
VH0603M120CGT101	12	0.1	55 at 1A	20	30	100	+/- 30%
VH0603M240CGT0R8	24	0.1	200 at 1A	100	150	0.8~1	+/- 30%
VH0603M240CGT2R5	24	0.1	200 at 1A	100	150	2~4	+/- 30%

#### SPECIFICATIONS

Part Number	Maximum Continuous Working Voltage	Typical ESD Trigger Voltage	Typical ESD clamping Voltage after 30ns	Leakage Current @V <sub>DC</sub>	Minimum ESD pulse withstand	Capacitance
						@1MHz
	V <sub>M</sub> (DC)	V <sub>T</sub>	V <sub>clamp</sub>	µA	Times	Cp
(V)	(V)	(V)	(V)	(V)		(pF)
VH0402M060CGT0R20	6	150	30	0.05	>2000	0.2-0.1/+0.5
VH0402M240CGT0R05	24	350	50	0.001	>2000	0.05+0.05/-0.05
VH0603M060CGT0R20	6	150	30	0.05	>2000	0.2-0.1/+0.5
VH0603M240CGT0R05	24	350	50	0.001	>2000	0.05+0.05/-0.05

## ■ Multilayer Chip Varistor (MLV) - VZ Series & VH Series

### ■ Quick Reference Specifications

#### VZ Series

Symbol  Part Number	Maximum Ratings					Specifications		
	Maximum Continuous Working Voltage		Maximum Non-Repetitive Surge Current (8/20 $\mu$ s)	Maximum Non-Repetitive Surge Energy (10/1000 $\mu$ s)	Max. Clamping Voltage at Specified Current (8/20 $\mu$ s)	Nominal Voltage at 1mA (DC) Current		Max. Capacitance @1KHz
	V <sub>M</sub> (DC)	V <sub>M</sub> (AC)	I <sub>TM</sub>	W <sub>TM</sub>	V <sub>c</sub>	V <sub>N</sub> (DC) Min.	V <sub>N</sub> (DC) Max.	C
	(V)	(V)	(A)	(J)	(V)	(V)	(V)	(pF)
VZ0402M050AGT	5.5	4	20	0.05	20 at 1A	8.0	11.0	295
VZ0402M090AGT	9	6	20	0.05	23 at 1A	10.2	13.8	190
VZ0402M110AGT	11	8	20	0.05	25 at 1A	12.75	17.25	160
VZ0402M140AGT	14	11	20	0.05	30 at 1A	15.3	20.7	135
VZ0402M180AGT	18	14	20	0.05	40 at 1A	21.6	26.4	93
VZ0603M050AGT	5.5	4	30	0.1	20 at 1A	8.0	11.0	800
VZ0603M090AGT	9	6	30	0.1	23 at 1A	10.2	13.8	680
VZ0603M140AGT	14	11	30	0.1	30 at 1A	15.3	20.7	350
VZ0603M180AGT	18	14	30	0.1	39 at 1A	21.6	26.4	270
VZ0603M260AGT	26	20	30	0.1	54 at 1A	29.7	36.3	200
VZ0603M300AGT	30	25	30	0.1	65 at 1A	35.1	42.9	120
VZ0603M380AGT	38	30	30	0.1	77 at 1A	42.3	51.7	100
VZ0805M050AGT	5.5	4	80	0.1	20 at 1A	8.0	11.0	1600
VZ0805M090AGT	9	6	80	0.1	23 at 1A	10.2	13.8	1180
VZ0805M140AGT	14	10	100	0.2	35 at 1A	15.3	20.7	1180
VZ0805M180AGT	18	14	100	0.2	39 at 1A	21.6	26.4	550
VZ0805M220AGT	22	17	100	0.2	44 at 1A	24.3	29.7	400
VZ0805M260AGT	26	20	100	0.3	54 at 1A	29.7	36.3	350
VZ0805M300AGT	30	25	100	0.3	65 at 1A	35.1	42.9	310
VZ0805M380AGT	38	30	100	0.3	77 at 1A	42.3	51.7	280
VZ0805M450AGT	45	35	80	0.3	90 at 1A	50.4	61.6	195
VZ1206M050AGT	5.5	4	100	0.2	20 at 1A	8.0	11.0	3200
VZ1206M140AGT	14	11	100	0.3	30 at 1A	15.3	20.7	1150
VZ1206M180AGT	18	14	100	0.3	38 at 1A	21.6	26.4	900
VZ1206M220AGT	22	17	100	0.4	44 at 1A	24.3	29.7	840
VZ1206M260AGT	26	20	100	0.5	54 at 1A	29.7	36.3	490
VZ1206M300AGT	30	25	100	0.6	65 at 1A	35.1	42.9	440
VZ1206M380AGT	38	30	100	0.7	77 at 1A	42.3	51.7	400
VZ1206M450AGT	45	35	100	0.8	90 at 1A	50.4	61.6	310
VZ1206M560AGT	56	40	100	1.0	110 at 1A	61.2	74.8	280
VZ1206M650AGT	65	50	100	0.5	135 at 1A	73.8	90.2	240
VZ1206M850AGT	85	60	100	0.6	165 at 1A	90.0	110	160



## ■ Multilayer Chip Varistor (MLV) - VZ Series & VH Series

### ■ Taping Specifications

#### A. Paper tape size specification:

Unit: mm

Label	0402	0603	0805	1206
A	$0.62 \pm 0.03$	$0.95 \pm 0.05$	$1.45 \pm 0.05$	$1.88 \pm 0.05$
B	$1.12 \pm 0.03$	$1.80 \pm 0.05$	$2.25 \pm 0.05$	$3.50 \pm 0.05$
K	$0.60 \pm 0.03$	$0.87 \pm 0.05$	$0.87 \pm 0.05$	$1.24 \pm 0.05$

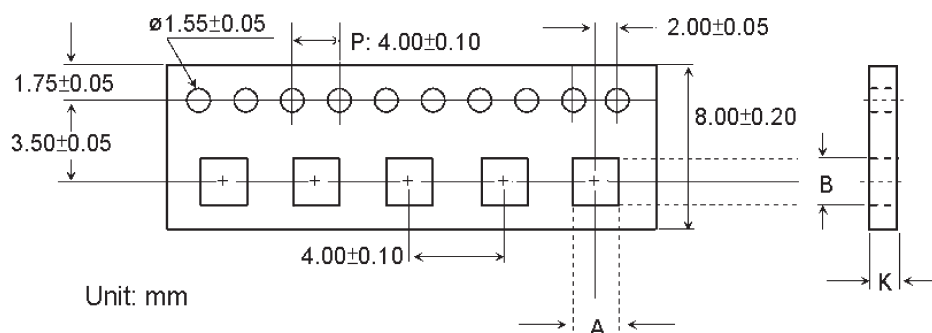

#### B. Reel size specification

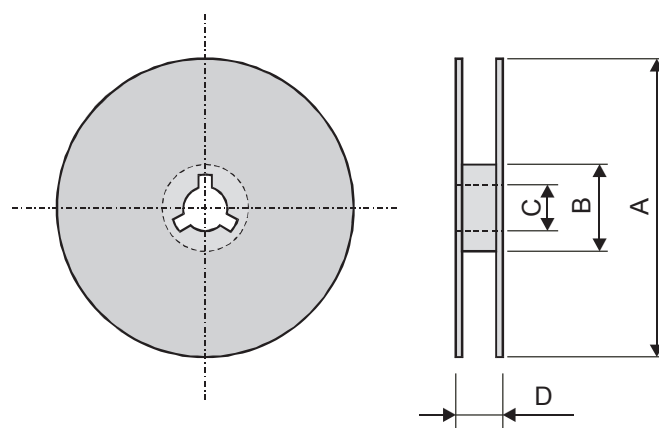

Symbol	A	B	C	D
Dimension	$\text{Ø}178.0 \pm 2.0$	$\text{Ø}60.0 \pm 1.0$	$13.0 \pm 0.2$	$10.0 \pm 1.5$

#### C. Packaging on tape & reel:

Size	0402	0603	0805	1206
Quantity / reel	10K pcs	4K pcs	3K pcs	3K pcs



# Walsin Technology Corporation

## **Yang-Mei Plant / Sales Office**

Walsin Technology Corporation  
556-1, Kao-Shi Road, Yang-Mei,  
Tao-Yuan, Taiwan  
Tel: +886-3-475-8711  
Fax: +886-3-475-7130  
Email: [info@passivecomponent.com](mailto:info@passivecomponent.com)

## **Kaohsiung Plant, Taiwan**

Walsin Technology Corporation  
1st, West 13 Street, K.E.P.Z.  
Kaohsiung, Taiwan  
Tel: +886-7-821-8171  
Fax: +886-7-813-1661  
Email: [info@passivecomponent.com](mailto:info@passivecomponent.com)

## **China - Dalang Plant / Sales Office**

Dongguan Walsin Tech. Electronics CO., Ltd.  
Xiniupo Administrative Zone,  
Dalang Town, Dongguan City,  
Guangdong Province 523799  
Tel: +86-769-3115168  
Fax: +86-769-3115188  
Email: [davidcheng@passivecomponent.com](mailto:davidcheng@passivecomponent.com)

## **China - Suzhou Plant / Sales Office**

Suzhou Walsin Technology Electronics Co., Ltd.  
No. 369, Changyan Street,  
Suzhou Industrial Park,  
Jiangsu Province 215126  
Tel: +86-512-628-36888  
Fax: +86-512-628-37888  
Email: [bingowang@passivecomponent.com](mailto:bingowang@passivecomponent.com)

## **China - Xi-An Sales Office**

E201, Tangy-Yue-Ge, Software Park,  
No.72 the 2nd Keji Road, Xi'an City,  
Shaanxi Province 710075  
Tel: +86-29-87607808  
Fax: +86-29-87607806  
Email: [susanch@263.net](mailto:susanch@263.net)

## **China - Tianjin Sales Office**

Walsin Technology Corporation (Tian Jin)  
No.51 The Ninth Avenue, Tianjin Technological  
Development Area(TEDA) Tianjin 300457  
Tel: +86-22-59820009  
Fax: +86-22-59820008  
Email: [Johnsonwang@passivecomponent.com](mailto:Johnsonwang@passivecomponent.com)

## **Malaysia - Kuala Lumpur Sales Office**

Walsin Technology Corporation, (M) SDN. BHD.  
Unit 208, Block B3, Leisure Commerce Square,  
No. 9, Jalan PJS 8/9, 46150 Petaling Jaya,  
Selangor Darul Ehsan, Malaysia  
Tel: +603-7877-8766  
Fax: +603-7877-8768  
Email: [teckanntan@my.passivecomponent.com](mailto:teckanntan@my.passivecomponent.com)

## **Malaysia - Penang Sales Office**

Walsin Technology Corporation(M) SND. BHD.  
1-3-6, Krystal Point II, Lebuah Bukit Kecil 6,  
11900 Bayan Lepas, Penang, Malaysia  
Tel: +604-6465767  
Fax: +604-6461767  
Email: [erinlee@my.passivecomponent.com](mailto:erinlee@my.passivecomponent.com)

## **Germany - Munich Sales Office**

Walsin Technology Corporation Europe  
Stefan-George-Ring 29, 81929 Munich, Germany  
Tel: +49-(0)89-9308-6475  
Fax: +49-(0)89-9308-6464  
Email: [aw@passivecomponent.com](mailto:aw@passivecomponent.com)

## **United States - West Coast Sales Office**

Walsin Technology Corporation, USA  
39500 Stevenson Place Suite 206,  
Fremont, CA 94539, USA  
Tel: +1-510-713-1190  
Fax: +1-510-713-8097  
Email: [leeku@passivecomponent.com](mailto:leeku@passivecomponent.com)

## **Singapore - Sales Office**

Walsin Electronics (S) Pte. Ltd.  
2 Jurong East Street 21,  
#04-33F IMM Building,  
Singapore 609601  
Tel: +65-6794-3600  
Fax: +65-6861-3381  
Email: [peterchew@sg.passivecomponent.com](mailto:peterchew@sg.passivecomponent.com)

## **JAPAN - R&D / Sales Office**

Walsin Technology Corporation (Japan)  
D-442, KSP R&D Business Park Building,  
3-2-1 Sakado Takatsuku, Kawasaki City,  
Kanagawa 213-0012, Japan  
Tel: +81-44-829-4626  
Fax: +81-44-829-4723  
Nitsuko Electronic Corporation  
Tel: +81-44-820-1570  
Fax: +81-44-820-1571  
Email: [sakanotsu@nitsuko-ele.co.jp](mailto:sakanotsu@nitsuko-ele.co.jp)